

AT60R

Owner's Manual

Before using this unit, carefully read the sections entitled: "IMPORTANT SAFETY INSTRUCTIONS" (p. 2), "USING THE UNIT SAFELY" (p. 3), and "IMPORTANT NOTES" (p. 4, 5). These sections provide important information concerning the proper operation of the unit. Additionally, in order to feel assured that you have gained a good grasp of every feature provided by your new unit, Owner's manual should be read in its entirety. The manual should be saved and kept on hand as a convenient reference.

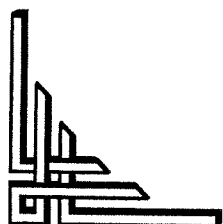

Copyright © 1999 ROLAND CORPORATION

All rights reserved. No part of this publication may be reproduced in any form without the written permission of ROLAND CORPORATION.

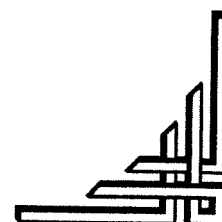

Roland®



 CAUTION RISK OF ELECTRIC SHOCK DO NOT OPEN	
ATTENTION: RISQUE DE CHOC ELECTRIQUE NE PAS OUVRIR	
CAUTION: TO REDUCE THE RISK OF ELECTRIC SHOCK, DO NOT REMOVE COVER (OR BACK). NO USER-SERVICEABLE PARTS INSIDE. REFER SERVICING TO QUALIFIED SERVICE PERSONNEL.	



The lightning flash with arrowhead symbol, within an equilateral triangle, is intended to alert the user to the presence of uninsulated "dangerous voltage" within the product's enclosure that may be of sufficient magnitude to constitute a risk of electric shock to persons.



The exclamation point within an equilateral triangle is intended to alert the user to the presence of important operating and maintenance (servicing) instructions in the literature accompanying the product.

INSTRUCTIONS PERTAINING TO A RISK OF FIRE, ELECTRIC SHOCK, OR INJURY TO PERSONS.

IMPORTANT SAFETY INSTRUCTIONS

SAVE THESE INSTRUCTIONS

WARNING - When using electric products, basic precautions should always be followed, including the following:

1. Read all the instructions before using the product.
2. Do not use this product near water — for example, near a bathtub, washbowl, kitchen sink, in a wet basement, or near a swimming pool, or the like.
3. This product should be used only with a cart or stand that is recommended by the manufacturer.
4. This product, either alone or in combination with an amplifier and headphones or speakers, may be capable of producing sound levels that could cause permanent hearing loss. Do not operate for a long period of time at a high volume level or at a level that is uncomfortable. If you experience any hearing loss or ringing in the ears, you should consult an audiologist.
5. The product should be located so that its location or position does not interfere with its proper ventilation.
6. The product should be located away from heat sources such as radiators, heat registers, or other products that produce heat.
7. The product should be connected to a power supply only of the type described in the operating instructions or as marked on the product.
8. The power-supply cord of the product should be unplugged from the outlet when left unused for a long period of time.
9. Care should be taken so that objects do not fall and liquids are not spilled into the enclosure through openings.
10. The product should be serviced by qualified service personnel when:
 - A. The power-supply cord or the plug has been damaged; or
 - B. Objects have fallen, or liquid has been spilled into the product; or
 - C. The product has been exposed to rain; or
 - D. The product does not appear to operate normally or exhibits a marked change in performance; or
 - E. The product has been dropped, or the enclosure damaged.
11. Do not attempt to service the product beyond that described in the user-maintenance instructions. All other servicing should be referred to qualified service personnel.

For the USA

This product may be equipped with a polarized line plug (one blade wider than the other) . This is a safety feature. If you are unable to insert the plug into the outlet, contact an electrician to replace your obsolete outlet. Do not defeat the safety purpose of the plug.

For Canada

For Polarized Line Plug

CAUTION: TO PREVENT ELECTRIC SHOCK, MATCH WIDE BLADE OF PLUG TO WIDE SLOT. FULLY INSERT.

ATTENTION: POUR ÉVITER LES CHOCS ÉLECTRIQUES, INTRODUIRE LA LAME LA PLUS LARGE DE LA FICHE DANS LA BORNE CORRESPONDANTE DE LA PRISE ET POUSSER JUSQU' AU FOND.

For the U.K.

IMPORTANT: THE WIRES IN THIS MAINS LEAD ARE COLOURED IN ACCORDANCE WITH THE FOLLOWING CODE.



BLUE: NEUTRAL
BROWN: LIVE

As the colours of the wires in the mains lead of this apparatus may not correspond with the coloured markings identifying the terminals in your plug, proceed as follows:
 The wire which is coloured BLUE must be connected to the terminal which is marked with the letter N or coloured BLACK.
 The wire which is coloured BROWN must be connected to the terminal which is marked with the letter L or coloured RED.
 Under no circumstances must either of the above wires be connected to the earth terminal of a three pin plug.







USING THE UNIT SAFELY

INSTRUCTIONS FOR THE PREVENTION OF FIRE, ELECTRIC SHOCK, OR INJURY TO PERSONS

About WARNING and CAUTION Notices









 WARNING	Used for instructions intended to alert the user to the risk of death or severe injury should the unit be used improperly.
 CAUTION	Used for instructions intended to alert the user to the risk of injury or material damage should the unit be used improperly. * Material damage refers to damage or other adverse effects caused with respect to the home and all its furnishings, as well to domestic animals or pets.

About the Symbols



	The  symbol alerts the user to important instructions or warnings. The specific meaning of the symbol is determined by the design contained within the triangle. In the case of the symbol at left, it is used for general cautions, warnings, or alerts to danger.
	The  symbol alerts the user to items that must never be carried out (are forbidden). The specific thing that must not be done is indicated by the design contained within the circle. In the case of the symbol at left, it means that the unit must never be disassembled.
	The  symbol alerts the user to things that must be carried out. The specific thing that must be done is indicated by the design contained within the circle. In the case of the symbol at left, it means that the power-cord plug must be unplugged from the outlet.

ALWAYS OBSERVE THE FOLLOWING









WARNING

- Before using this unit, make sure to read the instructions below, and the Owner's Manual. 
- Do not open or perform any internal modifications on the unit. 
- Make sure you always have the unit placed so it is level and sure to remain stable. Never place it on stands that could wobble, or on inclined surfaces. 
- Avoid damaging the power cord. Do not bend it excessively, step on it, place heavy objects on it, etc. A damaged cord can easily become a shock or fire hazard. Never use a power cord after it has been damaged. 
- In households with small children, an adult should provide supervision until the child is capable of following all the rules essential for the safe operation of the unit. 
- Protect the unit from strong impact. (Do not drop it!) 
- Do not force the unit's power-supply cord to share an outlet with an unreasonable number of other devices. Be especially careful when using extension cords—the total power used by all devices you have connected to the extension cord's outlet must never exceed the power rating (watts/amperes) for the extension cord. Excessive loads can cause the insulation on the cord to heat up and eventually melt through. 
- Before using the unit in a foreign country, consult with your retailer, the nearest Roland Service Center, or an authorized Roland distributor, as listed on the "Information" page. 

CAUTION

- Always grasp only the plug on the power-supply cord when plugging into, or unplugging from, an outlet or this unit. 
- Try to prevent cords and cables from becoming entangled. Also, all cords and cables should be placed so they are out of the reach of children. 

CAUTION

- Never climb on top of, nor place heavy objects on the unit. 
- Never handle the power cord or its plugs with wet hands when plugging into, or unplugging from, an outlet or this unit. 
- If you need to move the instrument, take note of the precautions listed below. At least two persons are required to safely lift and move the unit. It should be handled carefully, all the while keeping it level. Make sure to have a firm grip, to protect yourself from injury and the instrument from damage. 
 - Check to make sure the screws securing the unit to the stand have not become loose. Fasten them again securely whenever you notice any loosening.
 - Disconnect the power cord.
 - Disconnect all cords coming from external devices.
 - Close the lid.
 - Fold down the music stand.
- Before cleaning the unit, turn off the power and unplug the power cord from the outlet (p. 15). 
- Whenever you suspect the possibility of lightning in your area, pull the plug on the power cord out of the outlet. 
- Be careful when opening/closing the lid so you do not get your fingers pinched (p. 15). Adult supervision is recommended whenever small children use the unit. 
- When using the bench, please observe the following points: 
 - Do not use the bench as a toy, or as a stepping stool. 
 - Do not allow two or more persons to sit on the bench.
 - Do not sit on the bench if the bolts holding the bench legs are loose. (If the bolts are loose, immediately re-tighten them using the supplied wrench.)
 - When opening or closing the seat lid, be careful not to pinch your fingers. In particular, be careful not to pinch your fingers in the folding metal supports (p. 18).

IMPORTANT NOTES

In addition to the items listed under "IMPORTANT SAFETY INSTRUCTIONS" and "USING THE UNIT SAFELY" on pages 2 and 3, please read and observe the following:

Power Supply

- Do not use this unit on the same power circuit with any device that will generate line noise (such as an electric motor or variable lighting system).
- Before connecting this unit to other devices, turn off the power to all units. This will help prevent malfunctions and/or damage to speakers or other devices.

Placement

- Using the unit near power amplifiers (or other equipment containing large power transformers) may induce hum. To alleviate the problem, change the orientation of this unit; or move it farther away from the source of interference.
- This device may interfere with radio and television reception. Do not use this device in the vicinity of such receivers.
- Observe the following when using the unit's floppy disk drive. For further details, refer to "Before Using Floppy Disks".
 - Do not place the unit near devices that produce a strong magnetic field (e.g., loudspeakers).
 - Install the unit on a solid, level surface.
 - Do not move the unit or subject it to vibration while the drive is operating.
- Do not expose the unit to direct sunlight, place it near devices that radiate heat, leave it inside an enclosed vehicle, or otherwise subject it to temperature extremes. Also, do not allow lighting devices that normally are used while their light source is very close to the unit (such as a piano light), or powerful spotlights to shine upon the same area of the unit for extended periods of time. Excessive heat can deform or discolor the unit.
- To avoid possible breakdown, do not use the unit in a wet area, such as an area exposed to rain or other moisture.
- Do not allow rubber, vinyl, or similar materials to remain on the piano for long periods of time. Such objects can discolor or otherwise harmfully affect the finish.
- Do not put anything that contains water (e.g., flower vases) on the piano. Also, avoid the use of insecticides, perfumes, alcohol, nail polish, spray cans, etc., near the unit. Swiftly wipe away any liquid that spills on the unit using a dry, soft cloth.

Maintenance

- To clean the unit, use a dry, soft cloth; or one that is slightly dampened. Try to wipe the entire surface using an equal amount of strength, moving the cloth along with the grain of the wood. Rubbing too hard in the same area can damage the finish.
- Never use benzine, thinners, alcohol or solvents of any kind, to avoid the possibility of discoloration and/or deformation.

Repairs and Data

- Please be aware that all data contained in the unit's memory may be lost when the unit is sent for repairs. Important data should always be backed up on a floppy disk, or written down on paper (when possible). During repairs, due care is taken to avoid the loss of data. However, in certain cases (such as when circuitry related to memory itself is out of order), we regret that it may not be possible to restore the data, and Roland assumes no liability concerning such loss of data.

Memory Backup

- If the power to this unit is not switched on for an extended period of time (about 2 weeks), the contents of memory will be lost, and the unit will revert to its factory defaults. To avoid the loss of important data that has been placed in memory, a backup of your data should be periodically created on a floppy disk.

Additional Precautions

- Please be aware that the contents of memory can be irretrievably lost as a result of a malfunction, or the improper operation of the unit. To protect yourself against the risk of losing important data, we recommend that you periodically save a backup copy of important data you have stored in the unit's memory on a floppy disk.
- Unfortunately, it may be impossible to restore the contents of data that was stored on a floppy disk once it has been lost. Roland Corporation assumes no liability concerning such loss of data.
- Use a reasonable amount of care when using the unit's buttons, sliders, or other controls; and when using its jacks and connectors. Rough handling can lead to malfunctions.
- Never strike or apply strong pressure to the display.
- When connecting / disconnecting all cables, grasp the connector itself—never pull on the cable. This way you will avoid causing shorts, or damage to the cable's internal elements.
- A small amount of heat will radiate from the unit during normal operation.
- To avoid disturbing your neighbors, try to keep the unit's volume at reasonable levels. You may prefer to use headphones, so you do not need to be concerned about those around you (especially when it is late at night).
- When you need to transport the unit, package it in the box (including padding) that it came in, if possible. Otherwise, you will need to use equivalent packaging materials.
- Do not pull the music stand too far forward when setting/releasing its latches.

**Before Using Floppy Disks
Handling the Floppy Disk Drive**

- Install the unit on a solid, level surface in an area free from vibration. If the unit must be installed at an angle, be sure the installation does not exceed the permissible.
- Avoid using the unit immediately after it has been moved to a location with a level of humidity that is greatly different than its former location. Rapid changes in the environment can cause condensation to form inside the drive, which will adversely affect the operation of the drive and/or damage floppy disks. When the unit has been moved, allow it to become accustomed to the new environment (allow a few hours) before operating it.
- To insert a disk, push it gently but firmly into the drive—it will click into place. To remove a disk, press the EJECT button firmly. Do not use excessive force to remove a disk which is lodged in the drive.
- The indicator light for the disk drive lights up at full brightness when reading or writing data, and lights up at half brightness at other times. Don't try to eject the disk while reading or writing is in progress (that is, when the indicator light is lit up at full brightness). Attempting to do so may damage the magnetic surface of the disk, rendering it unusable.
- Remove any disk from the drive before powering up or down.
- To prevent damage to the disk drive's heads, always try to hold the floppy disk in a level position (not tilted in any direction) while inserting it into the drive. Push it in firmly, but gently. Never use excessive force.
- To avoid the risk of malfunction and/or damage, insert only floppy disks into the disk drive. Never insert any other type of disk. Avoid getting paper clips, coins, or any other foreign objects inside the drive.

Handling Floppy Disks

- Floppy disks contain a plastic disk with a thin coating of magnetic storage medium. Microscopic precision is required to enable storage of large amounts of data on such a small surface area. To preserve their integrity, please observe the following when handling floppy disks:
 - Never touch the magnetic medium inside the disk.
 - Do not use or store floppy disks in dirty or dusty areas.
 - Do not subject floppy disks to temperature extremes (e.g., direct sunlight in an enclosed vehicle). Recommended temperature range: 10 to 50° C (50 to 122° F).
 - Do not expose floppy disks to strong magnetic fields, such as those generated by loudspeakers.

- Floppy disks have a "write protect" tab which can protect the disk from accidental erasure. It is recommended that the tab be kept in the PROTECT position, and moved to the WRITE position only when you wish to write new data onto the disk.

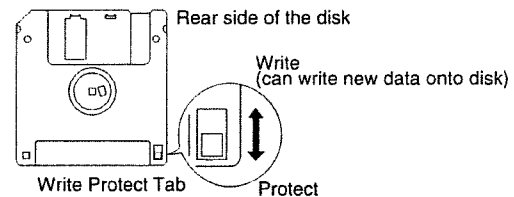

- The identification label should be firmly affixed to the disk. Should the label come loose while the disk is in the drive, it may be difficult to remove the disk.
- Store all disks in a safe place to avoid damaging them, and to protect them from dust, dirt, and other hazards. By using a dirty or dust-ridden disk, you risk damaging the disk, as well as causing the disk drive to malfunction.
- Disks containing performance data for this unit should always be locked (have their write protect tab slid to the "Protect" position) before you insert them into the drive on some other unit (except the PR-300, or a product in the HP-G, MT, KR, or Atelier families), or into a computer's drive. Otherwise (if the write protect tab remains in the "Write" position), when you perform any disk operations using the other device's disk drive (such as checking the contents of the disk, or loading data), you risk rendering the disk unreadable by this unit's disk drive.

- * GS (GS logo) is a registered trademark of Roland Corporation.
- * Apple is a registered trademark of Apple Computer, Inc.
- * Macintosh is a registered trademark of Apple Computer, Inc.
- * IBM is a registered trademark of International Business Machines Corporation.
- * IBM PC is a registered trademark of International Business Machines Corporation.
- * All product names mentioned in this document are trademarks or registered trademarks of their respective owners.

Features

We want to take a moment to thank you for your purchase of the Roland AT-60R “Atelier Series” Organ.

The AT-60R is an electronic organ which provides a generous collection of rich organ sounds. In addition, it is designed to be easy to learn and use.

In order to enjoy reliable performance of your new keyboard for many years to come, please take the time to read through this manual in its entirety.

Main Features

○ Simple and Easily Understood Operation

The large, color-coded buttons are organized by function, and laid out with an emphasis on ease of realtime operation. All models of the Atelier series use the same button arrangement, so that even beginners on the organ will be able to operate the instrument easily.

○ A Rich Array of Organ Sounds are Built-In

The AT-60R provides a rich array of organ sounds, including pipe organ, theater organ, and jazz organ sounds. Also, high-quality brass, flute, strings, etc., have been added to allow an even wider range of musical expression.

○ Human Voices and Phrases

In addition to its diverse organ voices, the AT-60R series instruments also offer unique vocals, such as “Jazz Scat,” and vocalized phrases such as “Amen.”

○ Harmony Intelligence

The AT-60R’s Harmony Intelligence function detects chords played on the Lower keyboard, and automatically adds harmony to what is played on the Upper keyboard. This allows you to add harmonic richness to your playing and create a more impressive performance.

New on the AT-60R is a Harp-type Harmony Intelligence feature that lets you easily simulate the beautiful sonorities of a harp.

○ Versatile Rhythms

The AT-60R contains 96 different Rhythms so you can enjoy playing along with the Rhythms of a variety of musical genres. In addition, the Arranger function lets you play an Automatic Accompaniment suitable for the Rhythm simply by using the Lower keyboard to specify a chord.

○ Disk Styles can be Loaded into Internal Memory

The Rhythm [Disk] button already contains 6 different Rhythms, but you can overwrite these with Rhythms loaded from a music style disk. When Rhythm data from the disk is loaded into internal memory, it will not be lost even if the power is turned off. It is convenient to load frequently-used disk Rhythms into internal memory.

○ SMF Music Data can be Loaded

The built-in composer features tape recorder-like operation. In addition to using the composer to easily record your playing, you can load SMF format music data and play along with it.

○ SMF Save

Since the AT-60R can save music data in SMF format, music data you create using an Atelier series organ can be easily edited on an external sequencer.

○ 61-note Lower Keyboard

The AT-60R features a 61-note lower keyboard with initial touch capable of conveying every dynamic nuance of your playing, plus a damper pedal—ideal for when you want to use expressive piano-style playing techniques.

The expansive 61-note keyboard can be split into two or more sections, allowing you to independently play a solo voice, pedal bass voice, or percussion for even more expressive possibilities. Since the lower keyboard can be divided into up to four parts, the lower keyboard can function essentially as four lower keyboards!

The Manual Drums function lets you play drum sounds or sound effects across the entire lower keyboard.

Conventions Used in This Manual

- Button names are enclosed in square brackets “[]”, as in [Utility] button.
- Whether a button light is illuminated, dark, or blinking is illustrated as shown below.



- Please be aware that although the display screens shown in this owner’s manual are generally based on the factory settings, some may not necessarily match the factory settings.
- [+][-], [▲][▼], [◀][▶] means that you should press one or the other button.
Example: Rhythm Select [-][+] buttons, Part Balance Reverb [▲][▼] buttons, Menu [◀][▶] buttons

Contents

USING THE UNIT SAFELY	3
Important Notes	4
Features	6
Main Features	6
Conventions Used in This Manual	7
Contents	8
Panel Descriptions	12
Before You Begin	15
Opening/Closing the Lid	15
Setting Up the Music Stand	15
Connecting the Power Cord	15
Turning the Power On and Off	16
Tuning On the Power	16
Turning Off the Power	16
Using Headphones	17
Using Microphone	17
Caution When Using the Bench	18
Restoring All the Factory Default Settings	18
Displaying Basic Screens (Display/Exit Button)	19
Rhythm Screen	19
Composer Screen	19
Start Playing the AT-60R	20
Listening to the Demo Songs	20
Selecting Voices	22
About the Voices and Parts	22
Functions of the Upper/Lower/Pedal Bass Sound Select Buttons	23
Selecting the Upper and Lower Voices	24
Selecting Pedal Bass Voice	26
Selecting Solo Voice	27
Selecting a Voice Using the [Others] Button	28
Adjust the Volume Balance (Part Balance Buttons)	30
Transpose the Pitch in Octave Units (Oct Shift Button)	31
Performing with a Human Voice	32
Selecting a Human Voice	32
Playing Drums and Sound Effects on the Keyboard	33
Playing Drums from the Entire Lower Keyboard (Manual Drums)	33
Changing the Drum Set Type	34
Playing Drums Together with the Lower Voices (Manual Perc Button)	35
Changing the Manual Percussion Type	36
Using the Rhythm (Music Style) Functions	37
Selecting a Rhythm	37
Playing Rhythms—Starting and Stopping the Rhythm	38
Starting at the Press of a Button	38
Starting the Rhythm Automatically When You Play the Lower Keyboard or Pedalboard – Sync Start	38
Stopping the Rhythm	39

Adding Variation to the Rhythm.....	40
Playing Rhythm and Automatic Accompaniment.....	41
Changing the Tempo (Speed) (Tempo Button).....	41
Using Easy Fingering to Play Chords	42
Leading Bass Function (Leading Bass Button).....	43
Lower Voice Hold Function — Sustaining Notes Played on the Lower Keyboard	43
A Simple Way to Make Automatic Accompaniment Settings — One Touch Program	44
Recalling Panel Settings Appropriate for Each Rhythm.....	45
Using a Rhythm (Music Style) from a Disk.....	46
Inserting and Ejecting a Floppy Disk.....	46
Playing the Disk Rhythms.....	46
Loading Disk Rhythms Into Internal Memory.....	47
Restoring the Rhythm Stored in the [Disk] Button to the Factory Settings	48
Adding Various Effects to a Voice	49
Adding Harmony to a Melody — Harmony Intelligence.....	49
Changing the Type of Harmony Intelligence	49
Rotary Effect.....	51
Chorus Effect.....	52
Reverb Effect	53
Sustain Effect.....	53
Effectively Using the Lower Keyboard	54
Making Effective Use of the Lower Keyboard.....	54
Playing the Solo Voice on the Lower Keyboard — Solo [To Lower] Button.....	56
Using the Lower Keyboard to Play the Bass Voice — [Bass Split] Button	57
Using the Lower Keyboard to Play the Bass Voice — [To Lower] Button	58
Using the Play Functions	59
Transposing to a Different Key (Transpose Button)	59
Adjusting the Overall Volume Using an Expression Pedal	60
Adding Decay to the Sound (Damper Pedal)	60
Pitch Bend and Vibrato Effects.....	61
Adjusting the Brightness of the Sound	61
Using the Foot Switches	62
Using the Registration Buttons	63
Storing Registrations.....	63
Recalling a Registration.....	64
How to Recall a Registration.....	64
Changing the Timing of Recalling Registrations	64
Automatically Registering When You Switch Panel Settings	65
Assigning a Name to a Registration Set.....	65
Copying Only the Name of a Registration	67
Saving Registration Sets to a Floppy Disk (Save Button).....	68
Loading Previously Saved Registration Sets Into the AT-60R (Load Button).....	69
Loading a Set of Registrations	69
Loading an Individual Registration.....	70
Deleting a Previously Saved Registration Set	71
Using Registrations Created on an Earlier Model.....	72
Record and Playback Your Performance	74

Contents

Recording Performances (Rec Button)	75
Recording Each Part Separately	76
Playing Back a Performance Song (Play Button)	77
Silencing a Specific Track — Track Mute	78
Re-Recording	79
Erasing a Performance Song (Clear)	80
Formatting Disks	81
Changing the Name of a Performance Song (Rename)	83
Saving Performance Songs Onto Floppy Disk (Save Button)	84
Saving in SMF Format	86
Loading Performance Songs Into the AT-60R	87
Layering a New Recording onto SMF Format Music Data	88
Playing Back Performance Songs Stored on Floppy Disk	89
Erasing Performance Songs Stored on Disk	90
Re-Recording Part of Your Performance — Punch-in Recording	91
Repeatedly Layering Performances Over a Region — Loop Recording	93
Settings for the Composer (Function Button)	95
Count-In Recording	95
Changing the Metronome Setting	95
Metronome Volume	95
Changing the Sound of the Metronome	95
Setting the Beat	96
How the Expression Pedal Functions (Exp. Source)	96
Function During Recording	96
Function During Playback	97
Muting Individual Channels of Performance Data	97
Switching the Display of Lyrics On (Displayed) or Off (Not Displayed)	98
Edit Menu (Editing Song Files)	99
Delete Part of the Recorded Song (Delete Measure (Bar))	99
Delete the Recording from a Track (Delete Track)	100
Erase Recording (Erase)	101
Copy Recording (Copy)	102
Correct Timing Inaccuracies (Quantize)	103
Adjusting the Effects	104
Changing the Reverb Type	104
Changing the Reverb Depth	105
Changing the Sustain Length	105
Rotary Speed	105
Rotary Color	105
Various Other Settings (Utility Button)	106
Initial Touch (Initial Touch ON/OFF)	107
Pedal Bass Mode (How the Bass Pedalboard Can Be Played)	107
Solo Mode (Changing How the Solo Voice Will Sound)	107
Regist Shift (Use the Right Foot Switch to Switch Through Registration Buttons)	107
Left/Right Foot Switch Assignment	108
Damper Pedal Assignment	109
Bender/Vibrato Destination	109

Pitch Bend Range	109
Harmony Intelligence Type (Selecting the Type of the Harmony Intelligence)	109
Manual Drums Set	109
Manual Percussion Set	110
Solo to Lower Mode (Layering the Solo Voice and Lower Voice)	110
Solo Split Point	110
Bass Split Point	110
Chord Hold (Chord Hold ON/OFF)	110
Registration Arranger Update (Arranger Settings Recall Timing)	111
Registration Transpose Update (Transpose Setting Recall Timing)	111
Expression Curve (Depth of the Expression Pedal Effect)	111
Tx MIDI Channel (MIDI Output Channel)	112
MIDI IN Mode	112
Send PC Switch (Specifying Transmission of PC Numbers)	113
PC Number (Specifying PC Numbers)	113
Master Tune	113
LCD Contrast	113
Connecting External Devices	114
Names and Functions of Jacks and Connectors	114
Making the Connections	114
Connecting Audio Equipment	114
Connecting a Computer	115
If You're Using MIDI	116
Connecting the AT-60R to a MIDI Instrument	116
<hr/>	
Troubleshooting	117
Display Messages	119
Voice List	121
Drum Set List	123
Manual Drum Set	123
Manual Percussion Set	126
Style List	127
Rhythm List (Music Style Disk)	129
Settings That Are Stored After the Power Is Turned Off	130
Settings That Are Stored After the Power Is Turned Off	130
Settings That Are Stored in the Registration Buttons	130
Settings That Are Stored in the Individual Registration Buttons	130
Chord List	131
Glossary	133
About ATELIER Series Sound Generator	134
MIDI IMPLEMENTATION	135
MIDI Implementation Chart	155
Demo Song List	156
Main Specifications	157
Index	159

Panel Descriptions

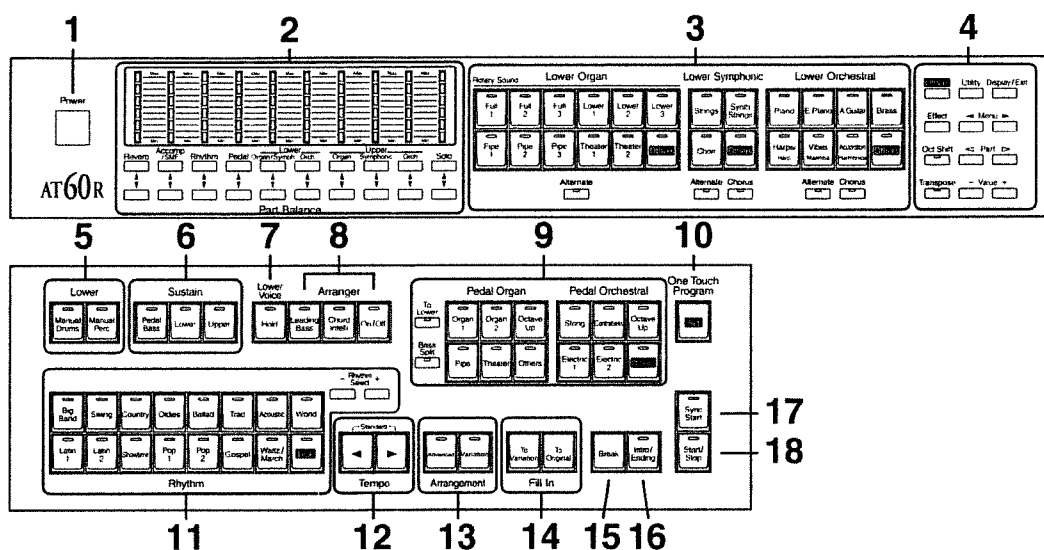

- | | |
|---|--|
| <p>1 [Power] switch (→ p. 16)</p> <p>2 Part Balance [▲] [▼] button/display (→ p. 30, p. 53)</p> <p>3 Lower Voice select buttons (→ p. 23, p. 24)
Lower Organ part
Lower Symphonic part
Lower Orchestral part
[Alternate] button
[Chorus] button (→ p. 52)</p> <p>4
[Others] button (→ p. 28)
[Effect] button (→ p. 104)
[Oct Shift] button (→ p. 31)
[Transpose] button (→ p. 59)
[Utility] button (→ p. 106-p. 113)
[Display/Exit] button (→ p. 19)
Menu [◀] [▶] buttons
Part [◀] [▶] buttons
Value [-] [+] buttons</p> <p>5 Lower
[Manual Drums] button (→ p. 33)
[Manual Perc] button (→ p. 35)</p> | <p>6 Sustain (→ p. 53)
[Pedal Bass] button
[Lower] button
[Upper] button</p> <p>7 Lower Voice [Hold] button (→ p. 43)</p> <p>8 Arranger
[Leading Bass] button (→ p. 43)
[Chord Intelli] button (→ p. 42)
Arranger [On/Off] button (→ p. 41)</p> <p>9 Pedal Bass voice select buttons (→ p. 23, p. 26)
Pedal Organ part
Pedal Orchestral part
[To Lower] button (→ p. 58)
[Bass Split] button (→ p. 57)</p> <p>10 [One Touch Program] button (→ p. 44)</p> <p>11 Rhythm select buttons (→ p. 37)
Rhythm Select [-] [+] buttons (→ p. 37)</p> <p>12 Tempo [◀] [▶] button (→ p. 41)</p> <p>13 Arrangement (→ p. 40)
[Advanced] button
[Variation] button</p> |
|---|--|

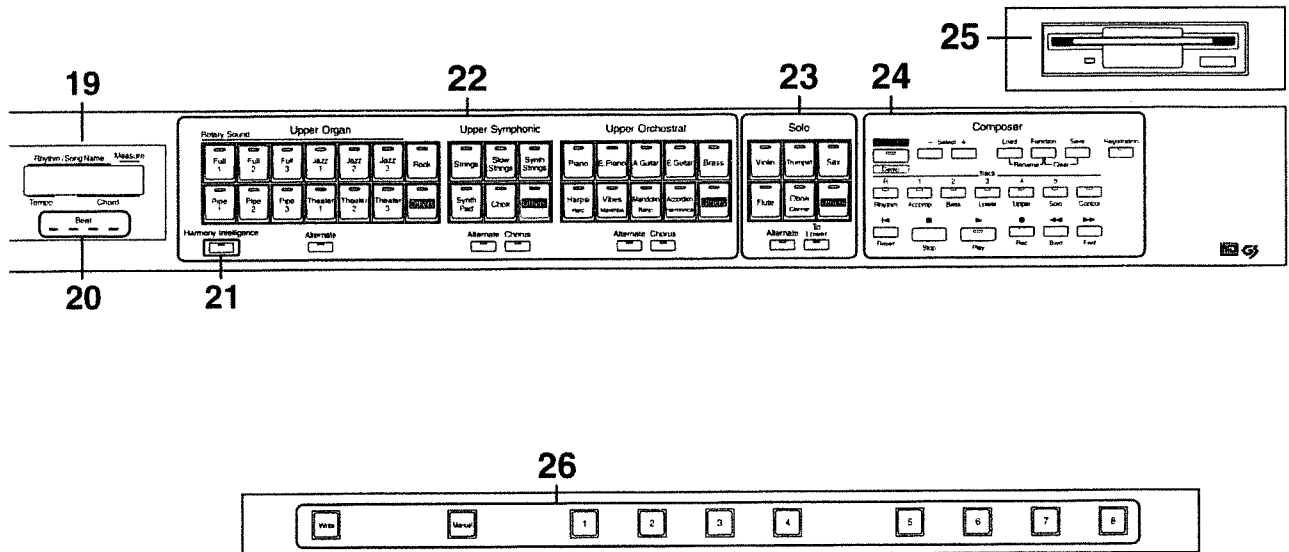

14 Fill In (→ p. 40)

[To Variation] button
[To Original] button

15 [Break] button (→ p. 40)

16 [Intro/Ending] button (→ p. 38)

17 [Sync Start] button (→ p. 38)

18 [Start/Stop] button (→ p. 38)

19 Display (→ p. 19)

20 Beat Indicator (→ p. 41)

21 [Harmony Intelligence] button (→ p. 49)

22 Upper voice select buttons (→ p. 23, p. 24)

Upper Organ part
Upper Symphonic part
Upper Orchestral part
[Alternate] button
[Chorus] button (→ p. 52)

23 Solo voice select buttons (→ p. 27)

Solo part
[Alternate] button
[To Lower] button (→ p. 56)

24 Composer

[All Song Play/Demo] button (→ p. 20, p. 89)
Select [-] [+] buttons
[Load] button (→ p. 69, p. 70, p. 87)
[Function] button (→ p. 95-p. 103)
[Save] button (→ p. 68, p. 84)
[Registration] button (→ p. 65-p. 73)
Track buttons (→ p. 74, p. 78)
[Reset] button
[Stop] button
[Play] button (→ p. 77, p. 89)
[Rec] button (→ p. 75, p. 76, p. 79)
[Bwd] button
[Fwd] button

25 Disk Drive (→ p. 46)

26 Registration buttons

[Write] button (→ p. 63)
[Manual] button (→ p. 65)
Registration [1] - [8] buttons (→ p. 63)

Panel Descriptions

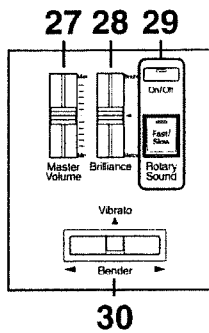

27 [Master Volume] knob (→ p. 16)

28 [Brilliance] knob (→p. 61)

29 Rotary Sound (→p. 51)

Rotary [On/Off] button

Rotary [Fast/Slow] button

30 [Bender/Vibrato] lever (→ p. 61)

■ Under the Lower Left of the Keyboard (→ p. 114)

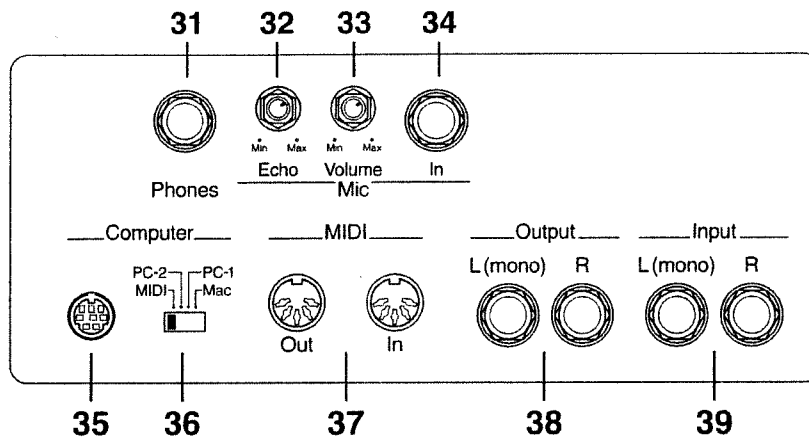

31 Phones jack

32 Mic Echo knob

33 Mic Volume knob

34 Mic In jack

35 Computer connector

36 Computer switch

37 MIDI Out / In connectors

38 Output L (mono) /R jacks

39 Input L (mono) / R jacks

Before You Begin

Opening/Closing the Lid

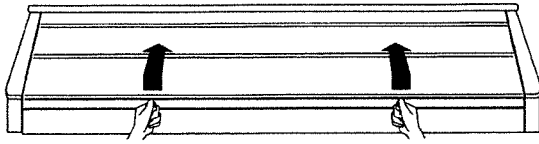

1. To open the lid, hold it with both hands and lift it straight up. Then, slide it to the rear.
2. To close the lid, slowly pull it forward with both hands until it stops. Then, gently lower it into place.

- * Be careful not to get your fingers caught when opening or closing the lid. Adult supervision is recommended when small children are going to be using the instrument.
- * To prevent accidents, be sure to close the lid before moving the organ.
- * Make sure you don't have anything (such as sheet music) on the keyboard when you close the lid.

Setting Up the Music Stand

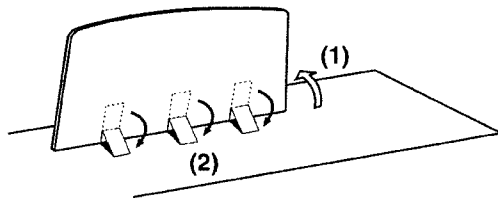

1. Lift the music stand gently.
2. Adjust the metal latches as shown in the illustration above.

- * Do not pull the music stand too far forward when setting/releasing its latches.

Connecting the Power Cord

1. First, make sure that the [Power] switch at the panel's left side is OFF (not pushed in).
2. Connect the supplied power cord to the AC Inlet connector, then plug the other end into an AC outlet.

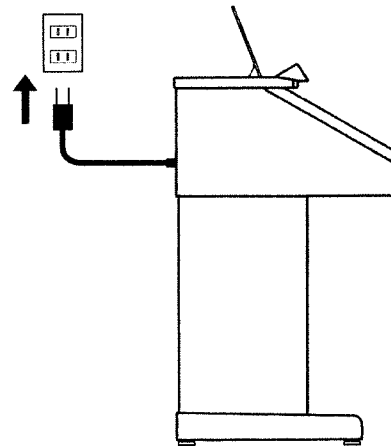

- * Only use the power cord supplied with this instrument.
- * Whenever you do not intend to use the instrument for extended periods of time, pull out the power cord from the AC outlet.

Before You Begin

Turning the Power On and Off

* Once the connections have been completed, turn on or off power to your various devices in the order specified. By turning on or off devices in the wrong order, you risk causing malfunction and/or damage to speakers and other devices.

■ Tuning On the Power

1. Make sure of the following before the power is turned on.

- Is the power cable correctly connected to the AC inlet?
- Is the power cable correctly connected to the AC outlet?
- Is the [Master Volume] slider (located at the left of the Lower Keyboard) set to the Min (minimum) position?

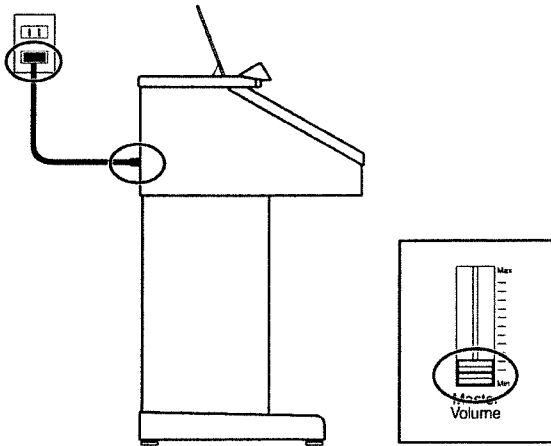

2. Press the [Power] switch to turn on the power.



* This unit is equipped with a protection circuit. A brief interval (a few seconds) after power up is required before the unit will operate normally.

3. The [Master Volume] slider located on the left of the Lower Keyboard panel is an overall control for adjusting the volume of the entire instrument.

Position the Expression Pedal to the half-way mark. Now adjust the [Master Volume] slider to a suitable level. Now that this level has been set, you can use the Expression Pedal to change the volume with your foot as you play the AT-60R. The volume will be increased when the Expression Pedal is pressed down, and decreased when the pedal is returned.

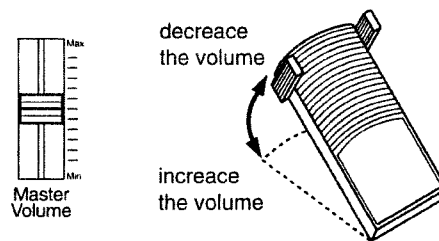

■ Turning Off the Power

1. Before switching the power off, set the [Master Volume] slider to the Min (minimum) position.
2. Press the [Power] switch to turn off the power.

Using Headphones

The AT-60R features a Phones jack. This allows you to play without having to worry about bothering others around you, even at night.

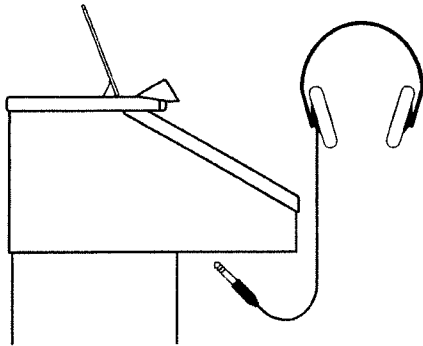

1. Connect the headphones to the Phones jack on the underside of the unit.

The sound from the built-in speakers stops. Now, sound is heard only through the headphones.



Phones

2. Adjust the headphones volume with the [Master Volume] slider and Expression pedal.

* Accepts connection of Stereo headphones.

Since sound is no longer output from the AT-60R's speakers once headphones are connected, you can practice late at night without disturbing others.



- To prevent damage to the cord, handle the headphones only by the headset or the plug.
- Headphones may be damaged if the volume is too high when they are plugged in.
Lower the volume on the AT-60R before plugging in headphones.
- To prevent possible auditory damage, loss of hearing, or damage to the headphones, the headphones should not be used at an excessively high volume.
Use the headphones at a moderate volume level.

Using Microphone

The AT-60R is equipped with a Mic jack. Since this instrument has a Mic In jack, you can use a microphone to enjoy a variety of possibilities such as singing along with your performance, or singing along with music data (such as separately sold SMF music data).

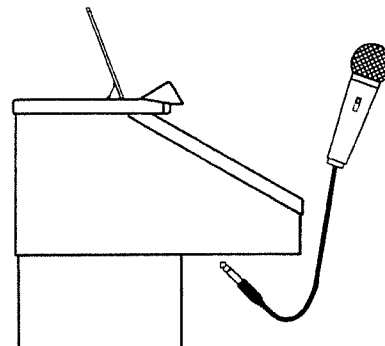

1. Connect the microphone to the Mic In jack on the underside of the unit.

2. Use the [Mic Volume] knob to adjust the volume level for the microphone.

3. Use the [Mic Echo] knob to adjust the echo level for the microphone.

* The microphone must be purchased separately. When purchasing a microphone, please consult the vendor where you bought the AT-60R.



- To avoid disturbing others, be careful of the volume level when playing late at night or very early in the morning.
- When connecting a microphone to the AT-60R, be sure to lower the volume. If the volume control is too high when the microphone is plugged in, noise may be produced by the speakers.
- Feedback could be produced depending on the location of microphones relative to speakers. This can be remedied by:
 - Changing the orientation of the microphone.
 - Relocating the microphone so it is farther from the speakers.
 - Lowering volume levels.

Caution When Using the Bench

The bench seat can be opened, and sheet music etc. can be stored inside.



When opening/closing the seat, be careful not to pinch your fingers.

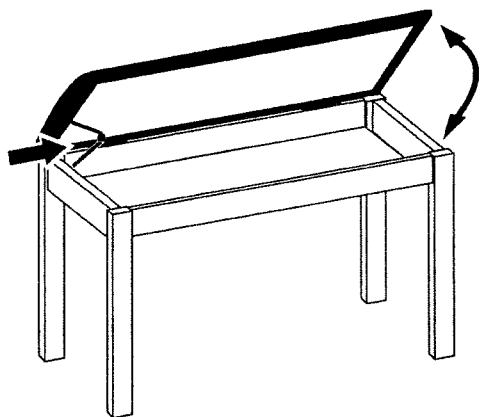

Restoring All the Factory Default Settings

The settings stored in the AT-60R can be returned to their factory settings. This function is called "Factory Reset."

1. Make sure there is no floppy disk in the disk drive before carrying out the procedure.
2. Turning off the power.
3. While holding down the [One Touch Program] button, press the [Power] switch to turn the power on.

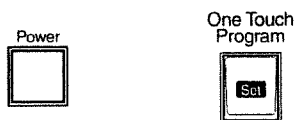

The following display appears.

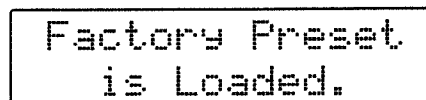

- * Loading factory default settings will erase any Registrations currently in the memory of the AT-60R. To save the registrations you are currently using, refer to page 68.
- * Even if you perform the Factory Reset operation, the Rhythm [Disk] button and [World] button will not return to the factory settings. If you wish to return the Rhythm [Disk] button and [World] button to the factory settings, refer to page 48.
- * When you are using the instrument for the very first time, or it has remained unused for about two weeks or so, it will automatically be returned to the factory default settings when the power is turned on.

Displaying Basic Screens (Display/Exit Button)

The instrument's display provides a large variety of information. The AT-60R has two types of basic display screen: the Rhythm display, and the Composer display. You can alternate from one to the other by pressing the [Display/Exit] button.

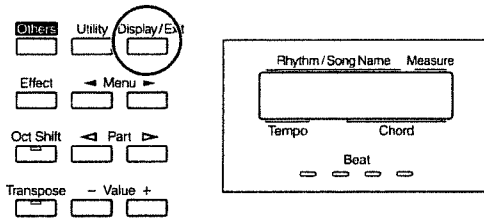

■ Rhythm Screen

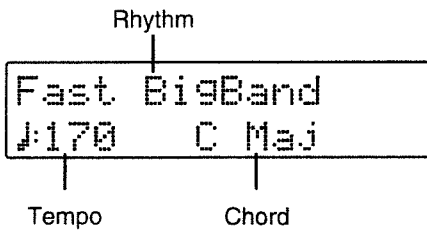

■ Composer Screen

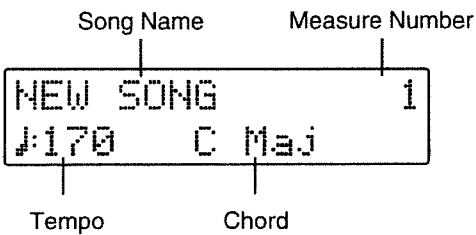

When you have selected a performance song on a floppy disk:

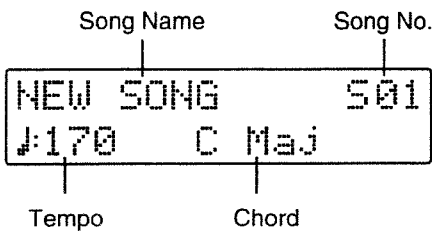

Start Playing the AT-60R

Listening to the Demo Songs

The AT-60R contains 5 Demo songs. Here's how to play the Demo songs, and fully appreciate the sounds, Rhythms, and Automatic Accompaniment that are available with the AT-60R.

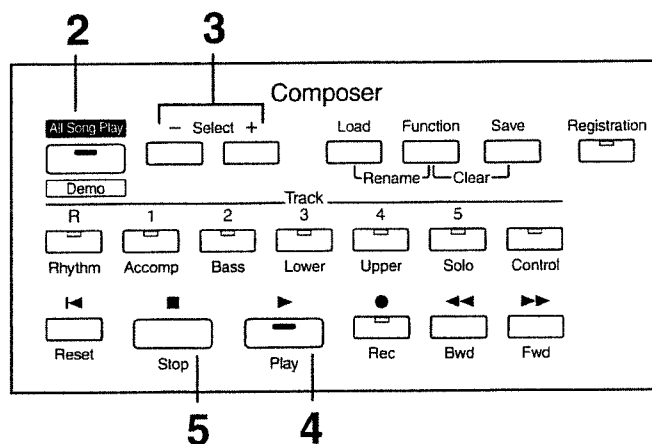

- 1. Make sure that a floppy disk is not inserted in the disk drive.**

If a floppy disk is in the disk drive, press the Eject button (p. 46) and remove the floppy disk.

- 2. Press the [All Song Play/Demo] button (the indicator will light).**

```
Big Band      :01
DEMO [-/+PLAY]
```

- 3. Use the [-] and [+] Composer Select buttons to select a Demo song.**

- 4. Press the [Play] button.**

When the selected demo song ends, the next demo song will begin playing.

- 5. To stop playback in the middle of the song, press the [Stop] button.**

The [All Song Play/Demo] button's indicator will be turned off.

● **If the Following Screen Appears**

If the performance song in the unit has not been saved to floppy disk, the following message will appear, and it will not be possible to play the Demo songs.

```
Clear Song Sure?  
Yes:REC No:RST
```

If you don't mind erasing this song, press the [Rec] button. However, if you wish to save this song, press the [Reset] button to cancel the procedure, and then save the song onto a floppy disk.



If you wish to save the musical data to a floppy disk, refer to "Saving Performance Songs Onto Floppy Disk (Save Button)" (p. 84).



All rights reserved. Unauthorized use of this material for purposes other than private, personal enjoyment is a violation of applicable laws.



The data for the Demo song that is being played is not available at the MIDI Out connector.



Check out the "Demo Song List" (p. 156) for information such as the names of the composers and players of the demo songs.

Selecting Voices

The AT-60R is able to produce the sounds of various instruments. These sounds are called "Voices."

■ About the Voices and Parts

The AT-60R has two keyboards and one Bass Pedalboard, as shown below. From top to bottom these are called the "Upper Keyboard," "Lower Keyboard," and "Bass Pedalboard."

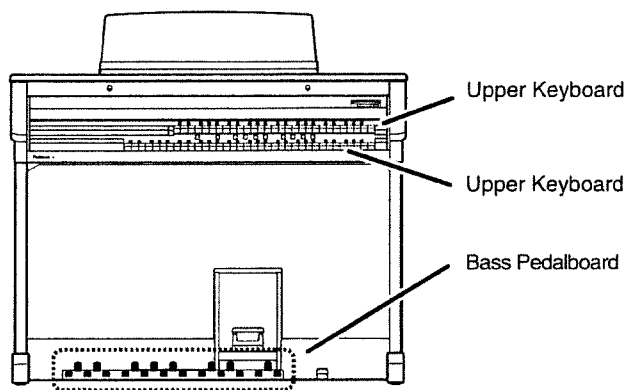

The Upper Keyboard and Lower Keyboard each have three parts: "Organ," "Symphonic," and "Orchestral." You can select one voice for each part, meaning that it is possible to layer up to three voices on each keyboard and play them simultaneously. The voice of the "Solo" part can be layered on the Upper keyboard.

The Bass Pedalboard has two parts: "Pedal Organ" and "Pedal Orchestral." You can select one voice for each part, meaning that it is possible to play up to two voices simultaneously.

Keyboard	Type of voices	Parts
Upper Keyboard	Upper	Upper Organ Upper Symphonic Upper Orchestral
	Solo	Solo
Lower Keyboard	Lower	Lower Organ Lower Symphonic Lower Orchestral
	Solo	Solo (This voice is sounded only when Solo [To Lower] button lights up)
Bass Pedalboard	Pedal Bass	Pedal Organ
		Pedal Orchestral



To play a Solo voice on the Lower keyboard, select the Solo voice and press the Solo [To Lower] button (p. 56).

■ Functions of the Upper/Lower/Pedal Bass Sound Select Buttons

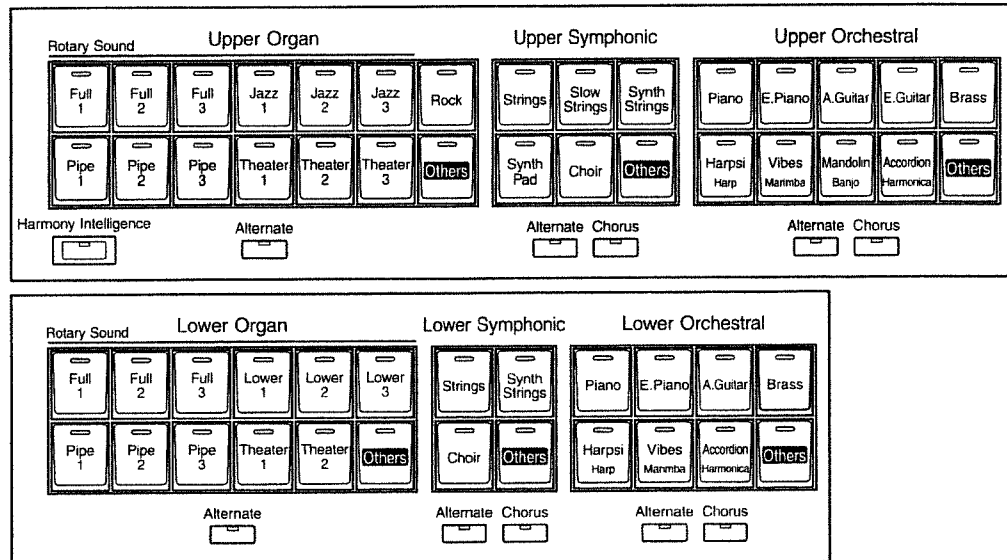

Each time you press a voice button, its indicator will switch between being lit and being turned off. Voices that have their button indicator lit can be played.

NOTE

If none of the voice buttons are lit, playing the keyboard will not produce a sound.

Two voices of the same family are assigned to each voice button. Buttons with voices from two different families have the names of both voices printed on them. The [Alternate] button switches between these two voices.

If the [Alternate] button is not lit the voice indicated on the button is selected.

If the [Alternate] button is lit, another voice of the same family or the voice indicated on the bottom half of the button is selected. For buttons which the voice indicated in the display will be selected.

■ Selecting the Upper and Lower Voices

Press the "Organ," "Symphonic," or "Orchestral" buttons for each Keyboard (Upper/Lower) to select the desired voice.

When the power is turned on, the Upper keyboard will play "Full Organ1" and the Lower keyboard will play "Lower Organ1."

Example: Selecting "Full Organ5" for the Upper Organ part, "Strings 5" for the Upper Symphonic, and Upper Orchestral "Grand Piano" for the Upper Orchestral.

1. Press the Upper Organ [Full 2] button (indicator lights).

The name of the selected voice will appear in the display for several seconds.

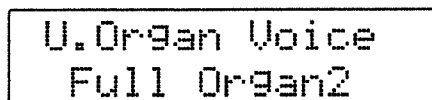

```
U.Organ Voice
Full Organ2
```

Now when you play the Upper keyboard, the "Full Organ2" will sound.

2. Press the Upper Organ [Alternate] button (the indicator lights).

When you play the Upper keyboard, the "Full Organ5" will sound.

Each time you press the [Alternate] button and switch between the two voices which are assigned the button.

3. Press the Upper Symphonic [Strings] button (the indicator lights).

Now when you play the Upper keyboard, the two voices "Full Organ5" and "Strings5" will sound simultaneously (mixed together).

4. Press the Upper Orchestral [Piano] button (the indicator lights).

When you play the Upper keyboard, "Grand Piano" will be added, producing a mixture of three different voices.

The Lower voice is selected in the same way as the voices of the Upper keyboard.

The Organ voices Full Organ 1 to Full Organ 6 are actually preset combinations of different organ footages with combinations as follows:

Full Organ 1 - 80 0000 004
Full Organ 2 - 88 8000 008
Full Organ 3 - 80 8808 008
Full Organ 4 - 80 0800 000
Full Organ 5 - 85 3111 246
Full Organ 6 - 88 8888 888

For example: a combination of "85 3111 246" means the following levels have been set:

16' is set at 8 (maximum)
8' is set at 5
5 1/3' is set at 3
4' is set at 1
2 2/3' is set at 1
2' is set at 1
1 3/5' is set at 2
1 1/3' is set at 4
1' is set at 6

Similarly, the "Jazz" organ voices are actually preset combinations of different Jazz organ footages and percussion with combinations as follows:

Jazz Organ 1 - 88 8000 000 with 3rd harmonic percussion
Jazz Organ 2 - 88 8800 000 with 3rd harmonic percussion
Jazz Organ 3 - 80 0800 000 with 2nd harmonic percussion
Jazz Organ 4 - 88 8000 000 with 2nd harmonic percussion
Jazz Organ 5 - 88 8800 000 with 2nd harmonic percussion
Jazz Organ 6 - 88 8630 000 with 3rd harmonic percussion

Likewise the "Pipe" organ and "Theater" organ voices are actually preset combinations of classical pipe and theater organ sounds experienced on our famous Rodgers organs. The Upper and Lower keyboards each have three parts; Organ, Symphonic, and Orchestral. One voice can be selected from each part, allowing you to mix (layer) up to 3 voices. Voices can be selected for the Lower keyboard in the same way as for the Upper keyboard.

Like the Upper keyboard organ voices, the Lower organ voices are actually preset combinations of different organ footages with combinations as follows:

Lower Organ 1 - 00 8000 000
Lower Organ 2 - 00 8400 000
Lower Organ 3 - 00 8503 000
Lower Organ 4 - 00 8000 005
Lower Organ 5 - 00 8640 000
Lower Organ 6 - 00 8402 001

■ Selecting Pedal Bass Voice

Immediately after the power is turned on, the Pedal Bass voice will sound single notes using the “Organ Bass1” voice. Here’s how to select Pedal Bass voices played by the Pedalboard.

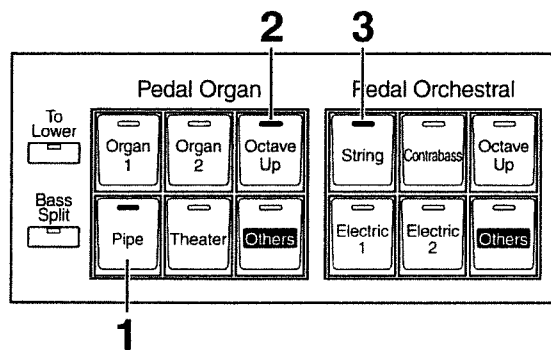

1. Press the Pedal Organ [Pipe] button (indicator lights).

The name of the selected voice will appear in the display for several seconds.

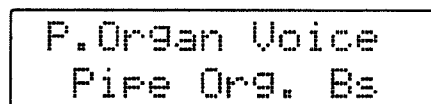

Now when you play the Pedalboard, “Pipe Org. Bs” (Pipe Organ Bass) will be heard.

2. Press the Pedal Organ [Octave Up] button (indicator lights).

Play the Pedalboard once more. Notice that when the [Octave Up] button is on, the selected Bass voice will sound an octave higher.

3. Press the Pedal Orchestral [String] button (indicator lights).

Now when you play the Pedalboard, the two voices Pipe Organ Bass and String Bass will sound simultaneously (mixed together).

The Bass voice is selected in the same way as the voices of the Upper and Lower keyboards. Each time you press a voice button, the indicator will alternate between being lit and being turned off, allowing you to play the voice for which the indicator is lit.

If all indicators are turned off (not lit), the Bass voice will not sound.



Settings can be adjusted to allow multiple notes to be played on the Pedalboard (p. 107).



If you press the [To Lower] button (indicator lights p. 58) or [Bass Split] button (indicator lights p. 57), the Bass voice can now be played by the Lower keyboard, not by the Pedalboard.

■ Selecting Solo Voice

The Solo section of the Upper keyboard is monophonic, that is, the Solo voice will only sound for the highest note played on the Upper keyboard. This allows you to play full chords and have the selected Solo voice playing the highest (solo) note.

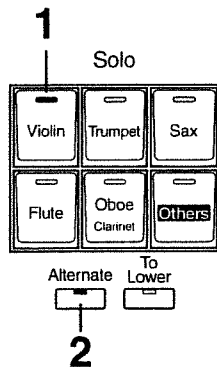

1. Press the Solo [Violin] button (indicator lights).

The name of the selected voice will appear in the display for a few seconds.

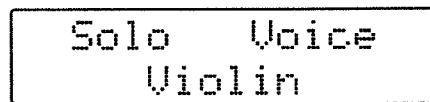

Play the Upper keyboard. The selected voice will sound by the highest note played.

2. When you press the [Alternate] button, the two voice assigned to the button will alternate.



By pressing the Solo [To Lower] button located below the Solo voice buttons, you can play the Solo voice from the Lower keyboard. For details refer to "Playing the Solo Voice on the Lower Keyboard — Solo [To Lower] Button" (p. 56).



It is possible to change how a Solo voice will sound. Normally, the Solo voice will be sounded by the highest note you play on the Upper keyboard, but you can make settings so that the last-played note will sound the Solo voice. You can also make settings so that the Solo voice will be sounded by all notes of the keyboard to which the Solo voice is assigned. For details refer to "Solo Mode (Changing How the Solo Voice Will Sound)" (p. 107).

■ Selecting a Voice Using the [Others] Button

Notice that there is an [Others] button for each of the “Organ,” “Symphonic,” “Orchestral” sections of the upper and lower voices, and “Solo” voices, and for the “Organ” and “Orchestral” sections of the Pedal bass voice. By using the [Others] buttons, you can select from all internal voices of the AT-60R.

The [Others] button is assigned two voice. You can use the [Alternate] button to switch between these two voices.



You cannot assign the same voice to the two available locations under each [Others] button. Please select and assign two different voices.

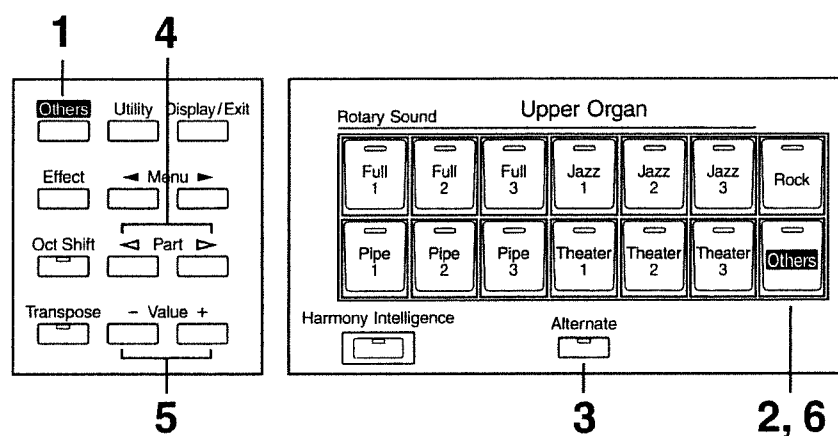

- 1. Press the [Others] button to the left of the display.**
All [Others] buttons and [Alternate] buttons begin to flash.
- 2. Press the [Others] button for the section (Part) to which you wish to assign a voice.**
The indicator of the selected [Others] button will blink.
- 3. Press the [Alternate] button to select ON (lit) or OFF (dark).**
The setting of the [Alternate] button: ON (lit) or OFF (dark), determines to which of the two available locations a newly selected voice will be assigned.
This step is unnecessary in the case of Pedal Bass Part.
- 4. Use the [◀] and [▶] Part buttons to select a sound group.**
The sound number of each voice is preceded by an alphabetical character A–V which indicates the sound group; e.g., “G11 Strings 1.”
- 5. Use the [-] and [+] Value buttons to select the desired voice.**
The name of the selected voice is shown in the display.

```
Others Select
E17 Theater Or.7
```

6. Once again, press the [Others] button for the part to which the selected voice will be assigned.

The selected voice is now stored, and will be retained even while the instrument is switched off. The voice will remain selected until you change it again.



To stop mid-way through this or any procedure, press the [Display/Exit] button.



About the voices that can be assigned to an [Others] button, please refer to "Voice List" (p. 121).

○ Shortcut When Selecting Voices for Any [Others] Button

Instead of using the general [Others] button located at the left of the display, here's a quicker way to select sounds for any [Others] button.

1. Press the [Others] button for the Part for which you wish to specify a voice.

The voice name will appear in the display.

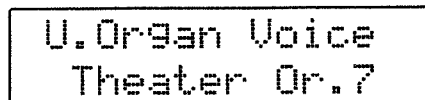

2. Press the [Alternate] button to select ON (lit) or OFF (dark).

The setting of the [Alternate] button: ON (lit) or OFF (dark), determines to which of the two available locations a newly selected voice will be assigned.

This step is unnecessary in the case of Pedal Bass Part.

3. While the voice name is shown in the display screen, use the Value [-] [+] buttons to select the desired voice.

The indicator of the selected [Others] button will blink.

4. Once again, press the [Others] button for the part whose sound you wish to set to confirm the voice.

The indicator of the [Others] button will change from blinking to lit.



When you press the [Others] button, the voice name will appear in the display screen, but the basic screen will reappear if you wait several seconds without pressing the Value [-] [+] buttons. If you wish to change the sound that is assigned to the [Others] button, press the [Others] button, and quickly use the Value [-] [+] buttons to select the desired voice while the voice name is still shown in the display screen.

Adjust the Volume Balance (Part Balance Buttons)

The AT-60R allows you to adjust the volume balance individually for each Part.

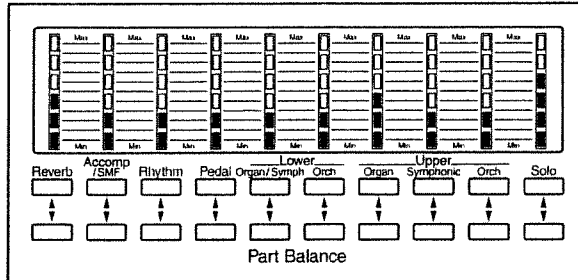

The following buttons are used to adjust the volume of a multiple number of Parts.

Accomp/SMF button

Automatic Accompaniment (except bass) and playback of performance songs from something other than the Atelier performance songs (for example: SMFs)

Rhythm button

- When Manual Perc is ON: Manual Percussion volume is adjusted.
- When Manual Perc is OFF: The volume of the Rhythm performance and Manual Drums is adjusted.

Pedal button

The volume of the Pedal Organ, Pedal Orchestral and Bass part of Automatic Accompaniment is adjusted.

Lower Organ/Symph button

The volume of the Lower Organ and Lower Symph is adjusted.

1. The volume levels of each part are adjusted using the corresponding [▲] and [▼] buttons.

When you press the up button (▲), the volume increases; when you press the down button (▼), the volume decreases.

The volume can be set to any value from 0 to 12.

The volume can be confirmed in the part balance display located at the left of the front panel.

When you press the Part Balance [▲] [▼] buttons, the volume for each part will be shown in the display.



When the volume value shown in the display is 0, that part will produce no sound.

Transpose the Pitch in Octave Units (Oct Shift Button)

Octave Shift is a function that allows you to alter the pitch of what is played by one or more octaves.

You can apply an Octave shift to the following nine Parts:

All of the Upper and Lower Parts (Organ/Symphonic/Orchestral)

Both the Bass Parts (Organ/Orchestral)

The Solo Part

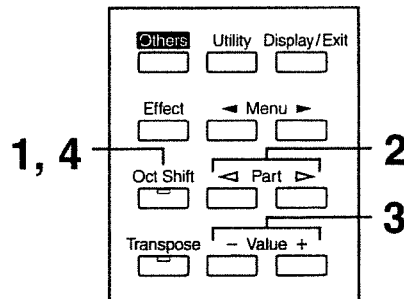

1. Press the [Oct Shift] button.

The [Oct Shift] button's indicator will flash.

2. Use the [◀] and [▶] Part buttons to select a performance Part to which you wish to apply an Octave Shift.

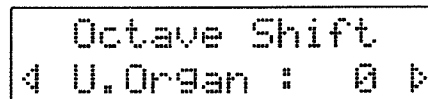

3. Use the [-] and [+] Value buttons to set the amount of shift.

The value can be set to a range of +/- 2 octaves.

4. Press the [Oct Shift] button.

The basic screen will reappear

When all Parts are set to value 0, the [Oct Shift] button's indicator goes off.

When any Part is set to any value other than 0, the [Oct Shift] button's indicator will light.



When the power is turned on, the Octave Shift setting for each part of the Pedal Bass will be set to -1 (1 octave down). If you turn on the Pedal Bass [Octave Up] button, the Octave Shift will be automatically set to "0" regardless of the previous setting. When you turn off the [Octave Up] button, the Octave Shift will always return to "-1" regardless of the previous setting.



Please note that when you apply the Octave Shift function to certain voices, their pitch could be stretched beyond their recommended note ranges, and they may not sound as expected. Care should be taken when using Octave Shift.

Performing with a Human Voice

The AT-60R contains various types of human voices. These are sounds that resemble the sound of people singing in certain styles.

■ Selecting a Human Voice

- 1. Press the [Others] button located at the left of the display.**

All [Others] buttons' and [Alternate] buttons' indicator will flash.

- 2. Press the [Others] button for the part to which you wish to assign one of the human voice types.**

The indicator of the selected [Others] button will flash, and the indicators of the remaining [Others] and [Alternate] buttons will be turned off.

- 3. Press the [Alternate] button to select either ON or OFF.**

Specify whether the voice will assigned to the ON (lit) or OFF (dark) position of the [Alternate] button.

- 4. Use the [◀] and [▶] Part buttons to select the sound group prefixed by "J" for the voice number.**

Human voice numbers are prefixed by "J."

- 5. Use the Value [-] [+] buttons to select the desired human voice.**

The display will show the name of the selected voice.

```
Others Select
J11 Jazz Scat
```



For the different human voice, refer to "Voice List" (p. 121).



Since "Jazz Scat" switches the sound between five levels depending on the strength with which you play the keyboard, the sound will not change if the Utility menu "Initial Touch" setting (p. 107) has been turned "OFF."

- 6. Once again, press the [Others] button for the part to which you wish to assign a human voice.**



To cancel mid-way through the selecting procedure, you can press the [Display/Exit] button.



When selecting a sound for the [Others] button, you can use a simpler procedure. For details refer to "○ Shortcut When Selecting Voices for Any [Others] Button" (p. 29).

Playing Drums and Sound Effects on the Keyboard

■ Playing Drums from the Entire Lower Keyboard (Manual Drums)

You can use the Lower keyboard to play various drum sounds (drum set). In this case, the Lower voices will no longer sound.

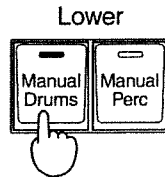

1. Press the [Manual Drums] button (indicator lights).

Play the Lower keyboard and listen to the various drum sounds on each key. The [Manual Drums] button will alternate between on (lit) and off each time it is pressed.

Immediately after the power is turned off, the STANDARD drum set will sound.



Refer to “Drum Set List” (p. 123) for details on which drum sound or Sound Effect will be played by each note.



It is not possible to select and play both [Manual Drums] and [Manual Perc] buttons (p. 35) simultaneously.

■ Changing the Drum Set Type

As the drum set, you can choose from 12 types of drum set and one type of sound effect. When you change the drum set, the sound produced by each note will change. Immediately after the power is turned on, the STANDARD drum set will sound. Let's try selecting a different Drum Set or the Sound Effect set.



Refer to "Drum Set List" (p. 123) for details on which drum sound or Sound Effect will be played by each note.

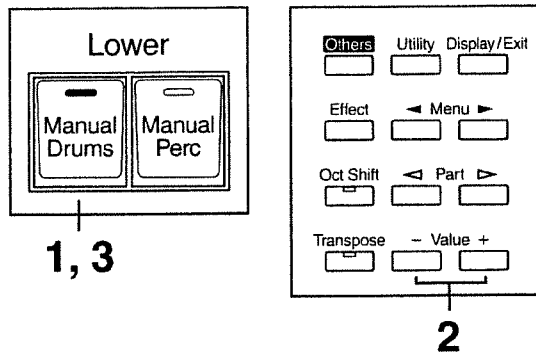

1. Press the [Manual Drums] button (indicator lights).
2. When the Drum Set name is displayed on the screen, press the [-] or [+] Value button to select a Drum Set or Sound Effect Set.

The [Manual Drums] button indicator will begin to flash.

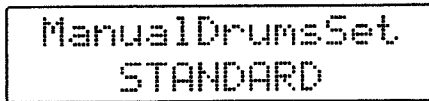

You can select from 12 different Drum Sets and one set of Sound Effects as follows:

STANDARD, STANDARD2, ROOM, ROOM2, POWER, ELECTRONIC, TR-808, DANCE, JAZZ, BRUSH, BRUSH2, ORCHESTRA, SOUND EFFECTS

3. Press the [Manual Drums] button once again.

The [Manual Drums] button indicator will be lit constantly, and the selected Drum Set Type will be applied.



To stop mid-way through this or any procedure, press the [Display/Exit] button.



The Drum Set Type can also be selected from the Utility menu. Please refer to "Manual Drums Set" (p. 109).

■ Playing Drums Together with the Lower Voices (Manual Perc Button)

You can play various drum sounds and Sound Effects using the 15 keys (E2–F#3) of the Lower keyboard. This is convenient when you wish to play the Lower voice together with drum sounds or Sound Effects.

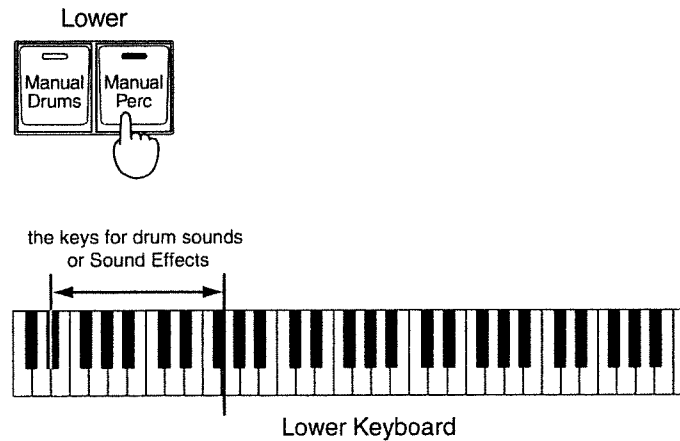

1. Press the [Manual Perc] button (indicator lights).

The button will alternate between ON (lit) and OFF each time it is pressed. When you play the 15 keys (E2–F#3) of the Lower keyboard and the various drum sound is played on each key.



It is not possible to select both [Manual Perc] and [Manual Drums] buttons (p. 33) simultaneously.

■ Changing the Manual Percussion Type

You can choose the type of Manual Percussion Set. When you change the Manual Percussion Set, the sound played by each of the 15 keys (E2-F#3) of the Lower keyboard will change.

Immediately after the power is turned on, the PERC.SET1 drum set will sound.



Refer to "Manual Percussion Set" (p. 126) for details on which percussion sound will be played by each note.

- 1. Press the [Manual Perc] button (indicator lights).**
- 2. When the Manual Percussion Set name is displayed on the screen, press the [-] or [+] Value button to select a Manual Percussion Set or the Sound Effects Set.**

The [Manual Perc] button indicator will begin to flash.

A rectangular box representing an LCD display. The text "Manual Perc. Set." is on the top line and "PERC.SET1" is on the bottom line, both in a monospaced font.

You can select from 3 different Manual Percussion Sets;
PERC.SET1, PERC.SET2, VOICE PHRASE

- 3. Press the [Manual Perc] button once again.**

The [Manual Perc] button indicator will be lit constantly, and the selected Manual Percussion Set will be applied.



To stop mid-way through this or any procedure, press the [Display/Exit] button.



The Manual Percussion Set type can also be selected from the Utility menu. Please refer to "Manual Percussion Set" (p. 110).

Using the Rhythm (Music Style) Functions

The AT-60R lets you enjoy playing along with a rhythmic accompaniment.

Selecting a Rhythm

The AT-60R provides 96 types of Rhythms and Automatic Accompaniments (Music Styles). These are organized into 16 groups.

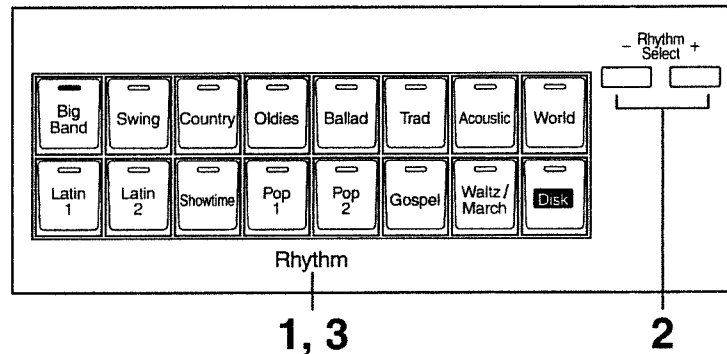

1. Press a Rhythm button to select a Rhythm group.

The indicator will light, and the first Rhythm in the group will be selected. That Rhythm will be shown in the display.

```
Fast BigBand
♩:170 C Maj
```

2. To select a different Rhythm within the same group, use the [-] and [+] Rhythm Select buttons.

The indicator of Rhythm button will flash.

3. Press the Rhythm button once again (indicator lights constantly).

The Rhythm button's indicator will change from blinking to light. The Rhythm has now been applied.

○ Using the Rhythms of the [Disk] Button

The [Disk] button contains 6 preset Rhythms. These Rhythms can be rewritten by loading disk Rhythms into the AT-60R.

Rhythms that are already written in the [Disk] button memory can be selected in the same way as when selecting Rhythms of another Rhythm group.



If you wish to store a disk Rhythm in the [Disk] button, refer to "Loading Disk Rhythms Into Internal Memory" (p. 47).

Playing Rhythms—Starting and Stopping the Rhythm

There are two ways to start the Rhythm:

1. Manually by pressing a button,
 2. Automatically by playing a note on the Lower keyboard or Pedalboard (Syncro Start).
- You can also make the Rhythm start after playing an Intro, or make the Rhythm stop after playing an Ending.

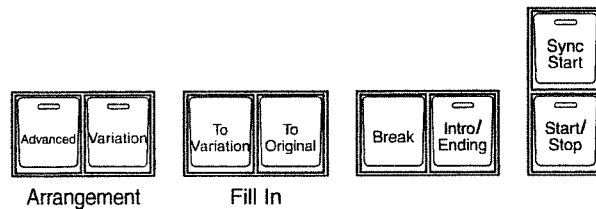

■ Starting at the Press of a Button

○ Starting with an Intro

- 1. Press the [Intro/Ending] button.**

The Intro is played and the Rhythm starts.

While the Intro is playing, the [Intro/Ending] button indicator will light, until the Intro ends then the button indicator will go dark.

○ Making the Intro Short and Simple

- 1. Press the [To Variation] or [To Original] button.**

- 2. Press the [Start/Stop] button.**

A short Intro is played and the Rhythm starts.

○ Starting without an Intro

- 1. Press the [Start/Stop] button.**

The Rhythm starts without an Intro being played.

■ Starting the Rhythm Automatically When You Play the Lower Keyboard or Pedalboard – Sync Start



If the Arranger function (p. 41) is ON (the Arranger [On/Off] button indicator is lit), it is not be able to start the Rhythm by playing the Pedalboard.

○ Starting with an Added Intro

- 1. Press the [Sync Start] button to make the indicator light up.**

2. Press the [Intro/Ending] button.

The [Intro/Ending] button's indicator will flash.

3. Play either the Lower keyboard or the Pedalboard.

The Intro is played and the Rhythm starts.

While the Intro is playing, the [Intro/Ending] button indicator will light, until the Intro ends the button indicator will be turned off.

○ Making the Intro Short and Simple

1. Press the [Sync Start] to make the indicator light up.

2. Press the [To Variation] or [To Original] button.

[Start/Stop] button indicator will flash.

Pressing the [To Variation] or [To Original] button makes the Rhythm pattern change as well.

3. Play either the Lower Keyboard or the Pedalboard.

A short Intro is played and the Rhythm starts.

○ Starting without an Intro

1. Press the [Sync Start] button (the indicator lights).

2. Play either the Lower keyboard or the pedalboard.

The Rhythm starts without an Intro being played.

■ Stopping the Rhythm

○ Stopping with an Ending

1. Press the [Intro/Ending] button.

An Ending is played, then the Rhythm stops.

While the Ending is playing, the [Intro/Ending] button indicator will light, until the Ending finishes the button indicator will be turned off.

○ Making the Ending Short and Simple

1. Press the [To Variation] or [To Original] button, and then press the [Start/Stop] button.

A short Ending is played, then the Rhythm stops.

○ Stopping without an Ending

1. Press the [Start/Stop] button.

The Rhythm will stop without an Ending being played.

Adding Variation to the Rhythm

You can add variation to the Rhythm by changing the arrangement or by switching the Rhythm pattern, or by inserting a break (which stops the Rhythm for one measure).

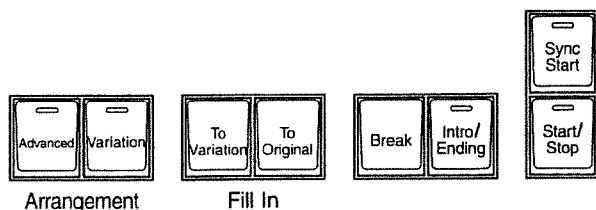

Button	Function
Arrangement [Advanced] button	Basic Arrangement (indicator off) / Full Arrangement (indicator lit)
Arrangement [Variation] button	Original Rhythm (indicator off) / Variation Rhythm (indicator lit)
Fill In [To Variation] button	After the Fill-In has played, play the Variation Rhythm pattern
Fill In [To Original] button	After the Fill-In has played, play the Original Rhythm pattern
[Break] button	Stops the Rhythm for one measure (break)

What is a Fill In?

A Fill In is a short phrase that is inserted at a break in the melody or at a point where the character of the song changes (between Chorus's or Verses).



The functions of the [Start/Stop] button, the [To Variation] button, the [To Original] button, the [Advanced] button and [Break] button can be assigned to the foot switches located on each side of the Expression Pedal (p. 108).



For some rhythms, the arrangement will not change even if you press the Arrangement [Advanced] button.

Playing Rhythm and Automatic Accompaniment

The Arranger function of the AT-60R can add an Automatic Accompaniment to each Rhythm. Based on the selected Rhythm, the Arranger function automatically adds an accompaniment that is suitable for the chord being pressed on the Lower keyboard.

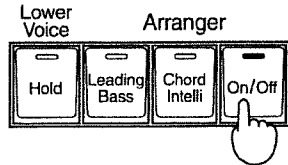

1. Press the Arranger [On/Off] button (indicator lights).

Indicator is lit (On) Rhythm and Automatic Accompaniment
 Indicator is not lit (Off) Rhythm (Drums only)

2. Start the Rhythm (p. 38).

The Rhythm and Automatic Accompaniment will play together.



If the Arranger[On/Off] button is ON and no Pedal Bass voice is selected, the Automatic Accompaniment will play the bass sound.



While the Intro or Ending is being played, the Lower keyboard voices will not play.

Changing the Tempo (Speed) (Tempo Button)

You can change the tempo of the Rhythm or Automatic Accompaniment.

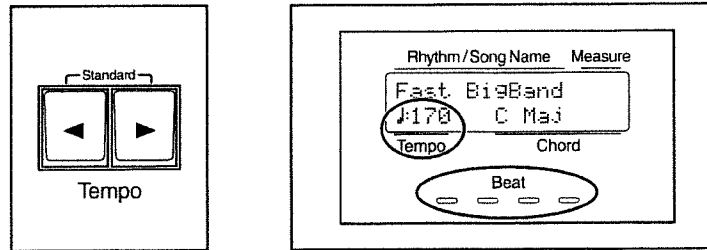

1. Press the [◀] and [▶] Tempo buttons to change the tempo (speed) of the Rhythm or Automatic Accompaniment.

Tempo [◀] button The tempo becomes slower
 Tempo [▶] button The tempo becomes faster



By pressing the [◀] and [▶] Tempo buttons simultaneously, the tempo is returned to the standard (preset) tempo for the selected Rhythm.

The value of the tempo currently set (20~250 beats per minute) can be checked in the display. You can also check the tempo by viewing the Beat indicator. The indicator flashes red on the first beat of the measure (bar), and green on the remaining beats.

Using Easy Fingering to Play Chords

“Chord Intelligence” is a feature that intelligently plays the correct accompaniment chords the moment you play a key specifying a chord on the Lower keyboard during Automatic Accompaniment.

To play a C chord on the Lower keyboard, for example, you usually have to press down the three keys C, E, and G; but with Chord Intelligence, you only have to press the C Key to initiate a C chord accompaniment.

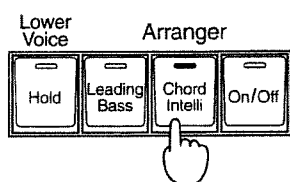

1. Press the [Chord Intelli] button (indicator is lit).

The Chord Intelligence function can now be used.

If you wish to turn off chord intelligence, press the [Chord Intelli] button once again (indicator is turned off).



For more information about chord fingering, see the “Chord List” (p. 131).

Leading Bass Function (Leading Bass Button)

When Automatic Accompaniment is used, and the [To Lower] switch for the Pedal Bass Part is ON, the Bass will normally play the root note of the chord you play on the Lower keyboard.

If the Leading Bass function is enabled, the lowest note of the chord you play on the Lower keyboard will then be used as the bass note (the bottom note of the chord).

This allows the bass to be a note other than the root of the chord you play and the bass note will change when inverted chords are played. This also allows you to play a descending bass line for chord progressions like in the tune "A White Shade Of Pale":

C (C root) / E min (B root) / A min (A root) / C (G root) / F (F root)
A min (E root) / D min (D root) / F (C root) etc.

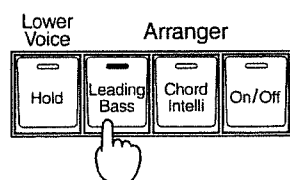

1. Press the [Leading Bass] button (indicator is lit).

The lowest note of the chord you play on the Lower keyboard will be used as the Bass note.

If you wish to turn off Leading Bass function, press the [Leading Bass] button once again to make the indicator go dark.



You can assign the [Leading Bass] button functions to either of the foot switches located on each side of the Expression Pedal (p. 108).

Lower Voice Hold Function — Sustaining Notes Played on the Lower Keyboard

When the Lower Voice [Hold] button is ON (Lower Voice [Hold] button's indicator is lit), the note(s) played on the Lower keyboard will continue to sound until you play the next note(s) – even if you release the keys you have played.

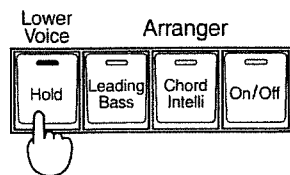

1. Press the Lower Voice [Hold] button (confirm that the indicator is lit).

The notes played on the lower keyboard will continue sounding.

If the Lower Voice [Hold] button is lit, pressing a key will cause the note to continue sounding.

When you press the Lower Voice [Hold] button to make the indicator go dark, the notes which had continued to sound will stop.

A Simple Way to Make Automatic Accompaniment Settings — One Touch Program

In addition to the Rhythm, you can also play an Automatic Accompaniment. The AT-60R provides a very convenient [One Touch Program] button. By simply pressing this button once, the Arranger function will be turned ON, and keyboard voices that are most appropriate for playing with the currently selected Rhythm/Automatic Accompaniment are selected.

By pressing the [One Touch Program] button, you can make the following settings.

○ When the Rhythm is Stopped

- [Sync Start] button lit, [Intro/Ending] button blinking (Waiting for Sync Start)
- Arranger [On/Off] button lit (Automatic Accompaniment playing)
- Panel settings appropriate for the Rhythm

1. Select a Rhythm (p. 37).

2. Press the [One Touch Program] button.

Panel settings suitable for the selected Rhythm and Automatic Accompaniment will be selected automatically.

3. On the Lower keyboard, play a chord.

At the moment you play the keyboard, the Intro will begin, and then the Rhythm and Automatic Accompaniment will play.

■ Recalling Panel Settings Appropriate for Each Rhythm

For each of the Rhythms (Music Styles) built into the AT-60R, there are four types of available panel settings, which are appropriate for use with that Rhythm (Music Style). These can be stored at Registration buttons [1] – [4].



If this procedure is carried out, the Registrations that were previously at Registration buttons [1] – [4] will be lost. If you wish to retain them, use the procedure explained on page 68 to save them to a floppy disk.

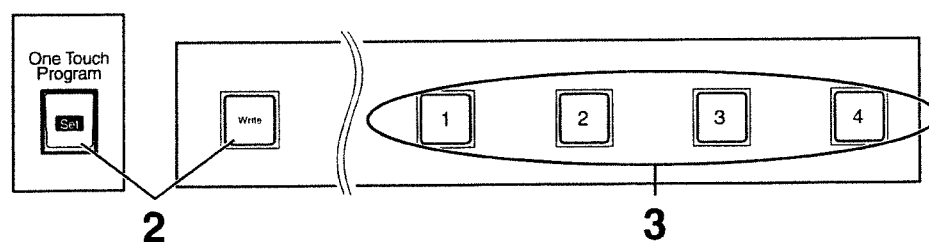

- 1. Select a Rhythm (p. 37).**
- 2. While holding the Registration [Write] button, press the [One Touch Program] button.**

The panel settings appropriate for the Rhythm will now be stored in Registration buttons [1] – [4].
- 3. To select and use the panel settings that you have stored, press one of the Registration buttons [1] – [4].**



When panel settings suitable for the rhythm are recalled, the Utility menu "Registration Arranger Update" settings will automatically change to "INSTANT."

Using a Rhythm (Music Style) from a Disk

The AT-60R contains 96 types of built-in Rhythms (Music Styles). Additional Rhythms (Music Styles) are available on the Music Style disk included are available. Here's how to select a Rhythm (Music Style) from a Music Style disk.

■ Inserting and Ejecting a Floppy Disk

NOTE

If you're using the disk drive for the first time, be sure to read the important notes on page 5.

- 1. Hold the floppy disk with the label facing upwards, and push it into the disk drive until it clicks into place.**

The disk drive is on the right side of the unit, above the keyboard.

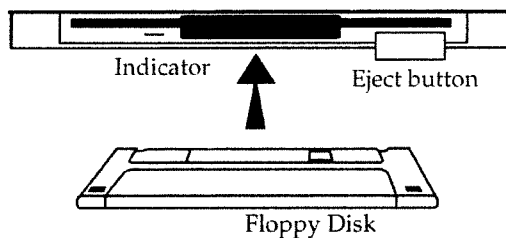

NOTE

Never attempt to remove a floppy disk from the drive while the drive is operating (the indicator is lit); damage could result to both the disk and the drive.

- 2. Press the Eject button.**

The floppy disk is ejected a little out of the slot. Gently grasp the end of the floppy disk and pull it out.

■ Playing the Disk Rhythms

- 1. Press the Rhythm [Disk] button (confirm that its indicator is lit)**
- 2. Insert the Music Style disk into the disk drive.**
- 3. Use the [-] [+] Composer Select buttons to select a Rhythm on the Music Style disk.**

NOTE

The [Start/Stop] button indicator will be blinking while the Rhythm is being loaded. You can play the selected Rhythm after loading is completed.

- 4. Press the [Start/Stop] button or the [Intro/Ending] button.**

The selected song is played.

■ Loading Disk Rhythms Into Internal Memory

The [Disk] button already contains 6 Rhythms, but these can be rewritten by Rhythms from a Music Style disk. Rhythms loaded from the disk into internal memory will not be lost even if the power is turned off. It is convenient to load frequently-used disk Rhythms into internal memory.

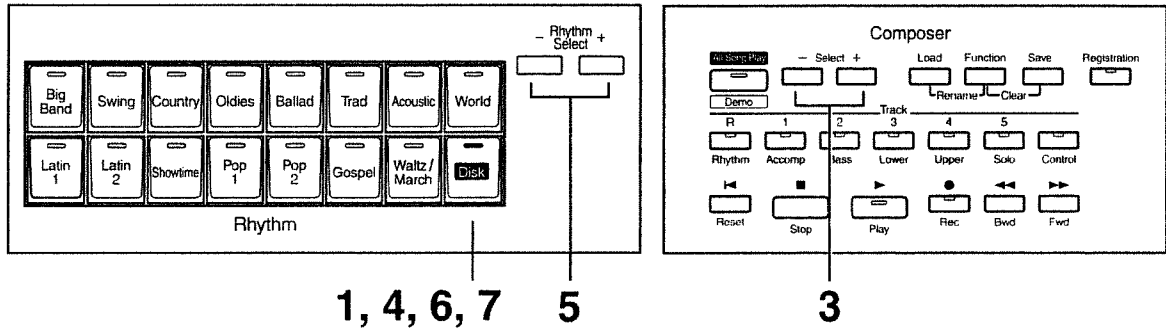

1. Press the Rhythm [Disk] button (indicator lights).
2. Insert the Music Style disk into the disk drive.
3. Use the [-] and [+] Composer Select buttons to select a disk Rhythm (indicator begins to flash).

```
BigBndBalld2 R01
J: 74 C Maj
```



Press the [Start/Stop] button, you can hear the Rhythm.

4. After selecting a disk Rhythm, press the Rhythm [Disk] button once more.

The following screen will appear.

```
To:Cute Pop
Write? +/-Disk
```

5. Use the the [-] and [+] Rhythm Select buttons to select where you wish the selected Rhythm to be stored.

Using the Rhythm (Music Style) Functions

6. Press the Rhythm [Disk] button to confirm the storage-destination Rhythm.

The following screen will appear.

```
Overwrite Style?  
Yes:Disk No:Exit
```

To cancel the procedure, press the [Display/Exit] button.

7. Press the Rhythm [Disk] button again to start loading the Rhythm into the internal memory.

While the Rhythm is being loaded into internal memory, the following screen will be displayed.

```
Overwriting  
Style...
```

Once the Rhythm has been accommodated in memory, the basic screen will reappear.



Never remove the disk or turn off the power while the Rhythm data is being loaded from disk into the AT-60R. If you do so, the Rhythm data will not be loaded into the AT-60R, and malfunctions could result. After returning the Rhythm stored in the [Disk] button to the factory settings (see following section), re-load the Rhythm from disk.

■ Restoring the Rhythm Stored in the [Disk] Button to the Factory Settings

The Rhythm that was loaded from the Music Style disk into the [Disk] button will not disappear even if you turn off the power or execute the Factory Reset operation. If you wish to restore the Rhythm of the [Disk] button to the factory setting, use the following procedure.

1. Press the [Power] switch to turn off the power.
2. Hold down the Rhythm [Disk] button, and press the [Power] switch.

The Rhythm that had been stored in the Rhythm [Disk] button will return to the factory settings.



To return settings other than those of the [Disk] button to the factory settings, use the Factory Reset operation (p. 18).



Hold down the Rhythm [World] button, and press the [Power] button. The Rhythm that had been stored in the Rhythm [World] button will return to the factory settings.

Adding Various Effects to a Voice

The AT-60R allows you to add a variety of effects to each voice, and to use various playing techniques to make your performance more expressive.

Adding Harmony to a Melody — Harmony Intelligence

Harmony Intelligence is a function that adds harmony to a single note being played on the Upper keyboard, the harmony being dependent on the chord played on the Lower keyboard. In addition it automatically selects the appropriate voices according to the Harmony type.

1. Press the [Harmony Intelligence] button (indicator lights).

Each time you press a [Harmony Intelligence] button, the indicator will alternate between ON (lit) and OFF.

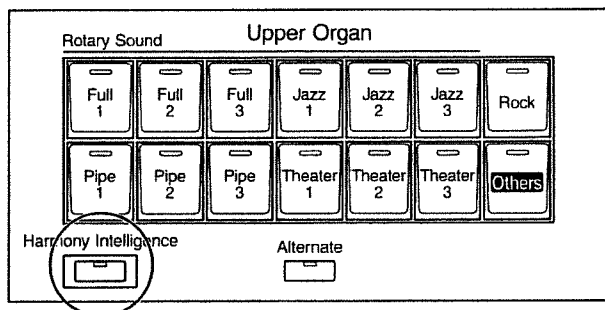

Changing the Type of Harmony Intelligence

There are 12 different Harmony Intelligence.

When you press the [Harmony Intelligence] button, the most appropriate voice(s) will be automatically set.

The manner in which notes will sound also depends on the Harmony type.

1. Press the [Harmony Intelligence] button (indicator lights).

2. While the type of Harmony Intelligence is shown in the display screen, use the Value [-] [+] buttons to select the Harmony Intelligence.

The indicator of the [Harmony Intelligence] button will blink.

3. Once again, press the [Harmony Intelligence] button.

The indicator of the [Harmony Intelligence] button will light, and the Harmony Intelligence is confirmed.



You may change the selected Solo voice and/or the Upper voice to one of your choice.

Adding Various Effects to a Voice

How notes pressed are sounded by the different Harmony Intelligence types:

	Type	How notes pressed are sounded
ORGAN	Type C	Upper
COMBO	Type B	Solo
STRINGS	Type A	Solo & Upper
HYMN	Type A	Solo & Upper
BLOCK	Type A	Solo & Upper
HARP	Type D	not sounded
JAZZ SCAT	Type B	Solo
BIG BAND	Type B	Solo
BROADWAY	Type A	Solo & Upper
TRADITIONAL	Type A	Solo & Upper
OCTAVE 1	Type A	Solo & Upper
OCTAVE 2	Type A	Solo & Upper

○ How notes are sounded by the different Harmony Intelligence types

Type A

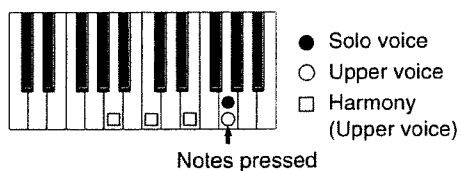

Type B (Solo)

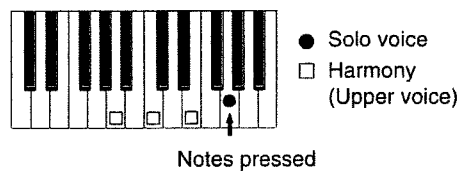

Type C

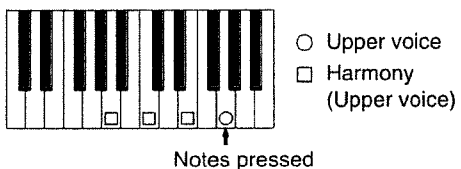

Type D

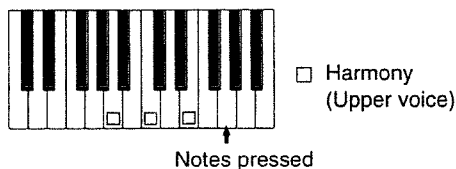

The number of notes of the harmony will depend on the Harmony Intelligence type.



The Harmony Intelligence type can also be selected from the Utility menu. Please refer to "Harmony Intelligence Type (Selecting the Type of the Harmony Intelligence)" (p. 109).

Rotary Effect

Rotary is an effect which simulates the sound of rotating speakers. There is a choice of two settings: Fast and Slow.

The Rotary effect can be applied to the following sounds.

- Voices assigned to buttons in the upper line of “Upper Organ” and “Lower Organ.” (Except the “Upper Organ” [Rock] button)



Some voices do not allow the Rotary effect to be applied. For details refer to “Voice List” (p. 121).

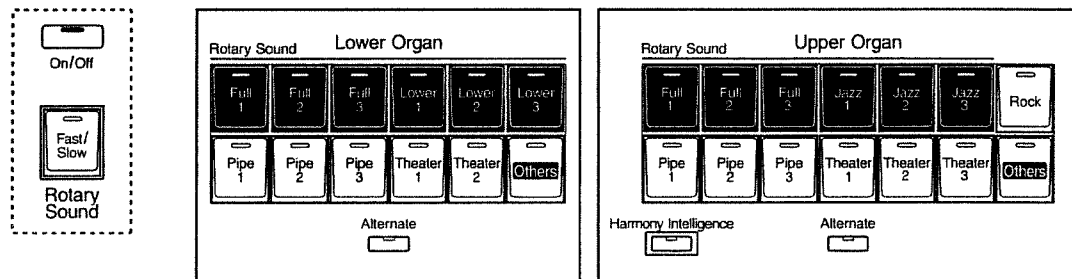

- 1. Select the voice to which you wish to apply the Rotary effect.**
- 2. Press the Rotary Sound [On/Off] button (confirm that its indicator is lit).**

The Rotary effect will be applied to the voice.

- 3. Press the Rotary Sound [Fast/Slow] button to switch between Rotary Fast (LED lit) and Rotary Slow (LED turned off).**

LED lit (Fast) The effect obtained is equivalent to speakers being rapidly rotated.

LED turned off (Slow) Effect simulating the slow rotation of speakers.



You can also finely adjust the speed of the speaker’s rotation (p. 105), and alter the brightness of the sound obtained when Rotary is enabled (p. 105).



You can assign the Rotary Sound [Fast/Slow] button function to the foot switches located on each side of the Expression Pedal (p. 108).

Chorus Effect

Chorus is an effect that adds expansiveness to a sound, making one instrument sound like several. The Chorus effect can be used on the four sections (Parts): Upper Symphonic, Upper Orchestral, Lower Symphonic and Lower Orchestral. (There is a Chorus button for each section). Additionally, the settings chosen for each individual voice (ON and OFF) will be remembered.

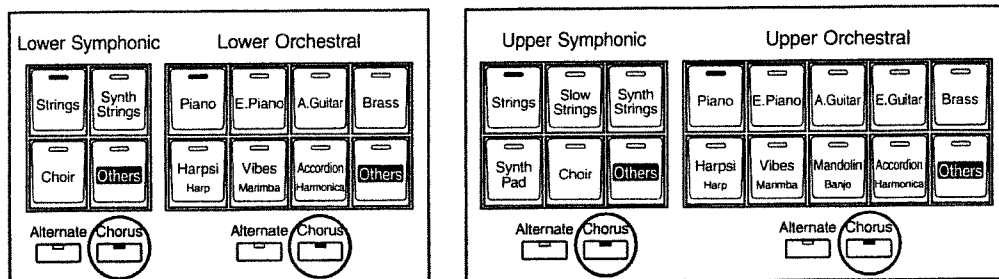

- 1. Select the voice in the above four sections you wish the Chorus effect to be added.**
- 2. Press the [Chorus] button that corresponds to the section (Part) of the selected voice (confirm that the indicator lights).**

The Chorus effect will be applied to the voice.



Some voices do not allow the Chorus effect to be applied. For details refer to "Voice List" (p. 121).



These settings remain stored in memory even while the power is off.

Reverb Effect

Reverb is an effect that adds a sense of spaciousness to the sound, creating the illusion of playing in a large or small concert hall, a large or small room, a small club, etc.

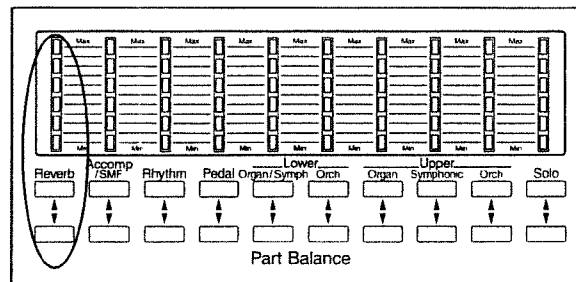

1. Press the Reverb [▲] or [▼] buttons in the far left side of the Part Balance section to adjust the overall Reverb amount.

When you press the up button [▲], additional Reverb is applied. Pressing the down button [▼] decreases the Reverb level.

If none of the Reverb indicators are lit, the Reverb effect will not be heard.



You can also select the type of Reverb you wish and the level for each individual Part. For details refer to "Changing the Reverb Type" (p. 104) and "Changing the Reverb Depth" (p. 105).

Sustain Effect

Sustain allows you to add a sustain effect or decay to each voice after the keys are released. The Sustain effect can be added to the Upper (except the Solo part), Lower, and Pedal Bass voices.

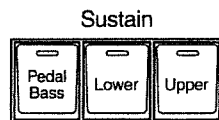

1. Press the Sustain button for the keyboard to which you wish to apply Sustain (indicator lights).

The Sustain effect can be applied simultaneously to the voices of the Upper part (except the Solo part), Lower part, and Pedal Bass part.



The length of Sustain can be modified independently for each keyboard (p. 105).



The Sustain effect will not be applied to the Solo part voice.

Effectively Using the Lower Keyboard

Making Effective Use of the Lower Keyboard

Since the lower keyboard of the AT-60R provides a generous 61 notes, you can use it to play piano pieces with ease. In addition, you can divide the keyboard into two or more sections and play solo voices, or play the pedal bass voice, or combine a variety of uses for even more versatility.

For example, the following applications are possible.

○ Using the Lower Keyboard to Play the Solo Voice

→ Use the Solo [To Lower] button in the Upper Solo section to Play the Solo voice to the Lower keyboard (p. 56).

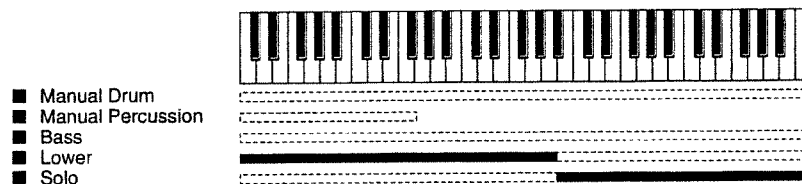

○ Using the Lower Keyboard to Play the Bass Part by Hand

→ Use the [Bass Split] button in the Pedal section to play the Pedal Bass voice from the Lower keyboard (p. 57).

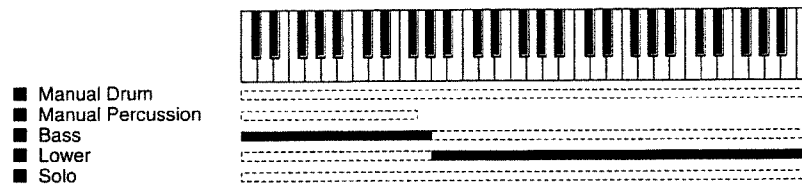

○ Using the Lower Keyboard to Play Drum Sounds or Sound Effects

→ Use the [Manual Perc] button (p. 35) in the far left corner of the lower panel to play drum sounds or sound effects simultaneously with the Lower voice.

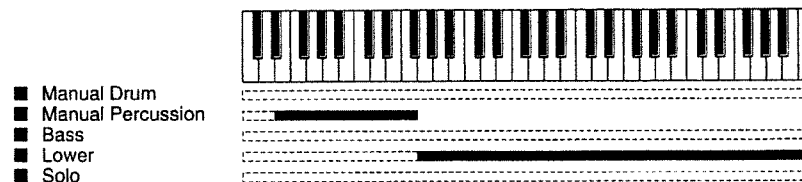

○ **Playing Drum Sounds from the Entire Lower Keyboard**

→ Press the [Manual Drums] button (p. 33) in the far left corner of the lower panel.

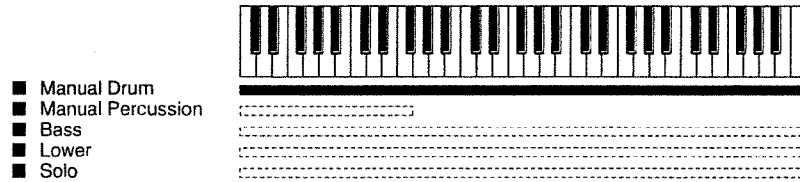

By changing the combination of voices that are played on the Lower keyboard, and by changing the Solo Split Point and Bass Split Point, you can create the following types of setup.

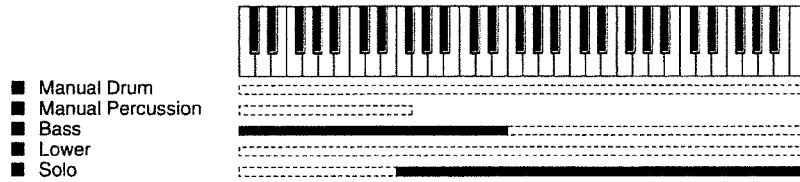
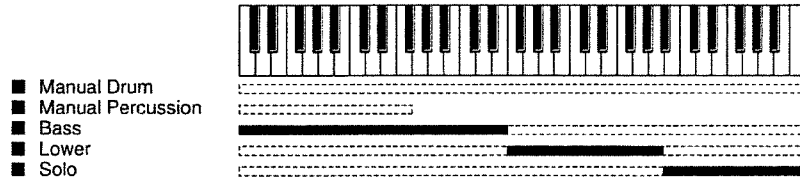
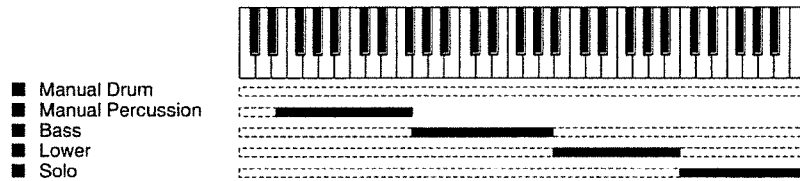

Playing the Solo Voice on the Lower Keyboard — Solo [To Lower] Button

This feature allows you to play the Solo part voice from the Lower keyboard in the area that extends to the right of B4, and includes B4 (B4 is referred to as the Solo Split Point).

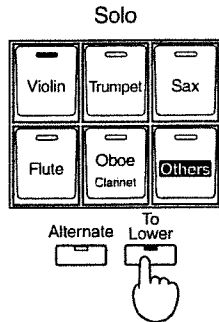

1. **Select a Solo voice.**
2. **Press the Solo [To Lower] button (indicator lights).**

When you play the Lower keyboard, the Solo voice will sound in the range to the right of the Solo Split Point.

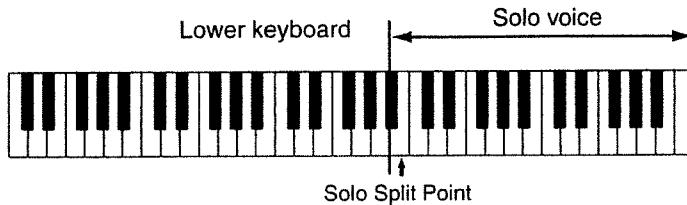

You can adjust the Solo Split Point (p. 110).

3. **To turn off the Solo split, press the Solo [To Lower] button (indicator is turn off).**

The Solo voice will no longer sound in the Lower keyboard; the Solo voice will now be played in the Upper keyboard.



You can layer the Solo voice with the Lower voice so that they will sound together (p. 110).



It is possible to change how a Solo voice will sound.

Normally, the Solo voice will be sounded by the highest note you play on the Upper keyboard, but you can make settings so that the last-played note will sound the Solo voice. You can also make settings so that the Solo voice will be sounded by all notes of the keyboard to which the Solo voice is assigned. For details refer to "Solo Mode (Changing How the Solo Voice Will Sound)" (p. 107).

Using the Lower Keyboard to Play the Bass Voice — [Bass Split] Button

This feature allows you to play the Bass part voice from the Lower keyboard in the area that extends to the left of C3, and includes C3 (C3 is referred to as the Bass Split Point).

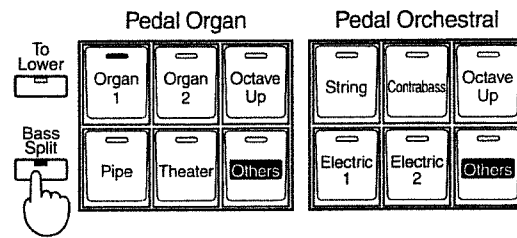

1. Select a Pedal Bass voice (p. 26).
2. Press the [Bass Split] button (indicator lights).

When you play the Lower keyboard, the Pedal Bass voice will sound in the range to the left of (and including) the C3 note.

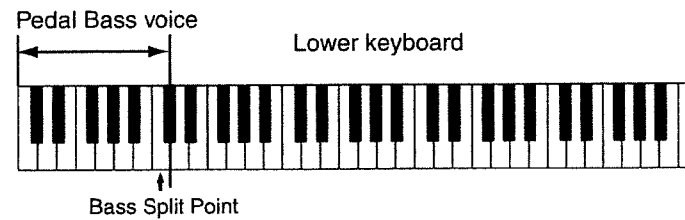

3. To turn off the Bass split, press the [Bass Split] button (indicator is turn off).

The Bass voice will no longer sound in the Lower keyboard; the Bass voice will now be played in the Pedalboard



You can adjust the Bass Split Point (p. 110).



It is not possible to use both [Bass Split] and [To Lower] (p. 58) button simultaneously.



If the [Bass Split] button is ON (indicator lights), the Pedal Bass voice will not sound from the pedalboard.

Using the Lower Keyboard to Play the Bass Voice — [To Lower] Button

By using the [To Lower] button, you can sound the Pedal Bass voice by playing the root note (see p. 133) of a chord on the Lower keyboard.



If no portion of the Lower keyboard is sounding the Lower voice (the [Manual Drums] button is ON), the Pedal Bass voice will not sound.

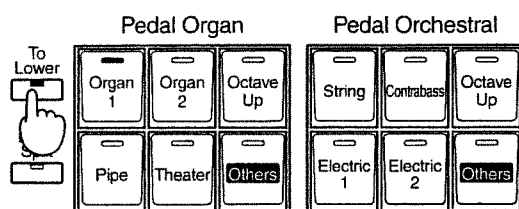

- 1. Select a Pedal Bass voice (p. 26).**
- 2. Press the [To Lower] button (indicator lit).**

When you play a chord in the area of the Lower keyboard that sounds the Lower voice, the Pedal Bass voice will also be heard and will play the root note.

Now when you play C/E/G on the Lower keyboard, the C (bottom note) will also play the Bass voice. In this way, the Bass voice will be played by the root note of the chord you play on the Lower keyboard.

If the [Leading Bass] button is lit (ON), the lowest note you play in the Lower keyboard will sound the Pedal Bass voice.



It is not possible to use both [To Lower] and [Bass Split] (p. 57) features simultaneously.



If the [To Lower] is ON, the Pedal Bass voice will not be heard from the Pedalboard.

Using the Play Functions

Transposing to a Different Key (Transpose Button)

This function allows you to transpose the keyboard to another key in semitone steps. For example: you may play in the familiar C major scale while your music will sound in any key of your choice.

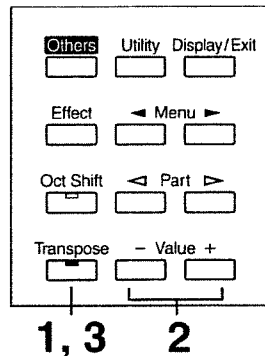

- 1. Press the [Transpose] button (indicator will flash).**
- 2. Set the transpose value using the [-] and [+] Value buttons.**

Each press of the [-] or [+] Value button transposes the key a semitone. Acceptable values range from A \flat to G (in semitone steps).

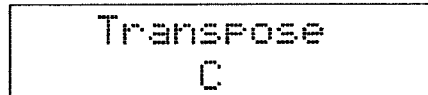

By pressing the Value [-]/[+] buttons simultaneously, you can restore the default setting C.

- 3. Press the [Transpose] button to return to the basic screen.**

If the transpose function is set to any key other than C, the [Transpose] button indicator will be lit. If the pitch is not transposed, (i.e., the key is C), the [Transpose] button indicator will be dark.



The transposition setting is stored in the Registration. For details on the settings that are stored in the Registration, refer to "Settings That Are Stored After the Power Is Turned Off" (p. 130).



You can change the timing at which the transposition settings saved in a Registration will be recalled. For details refer to "Registration Transpose Update (Transpose Setting Recall Timing)" (p. 111)

Adjusting the Overall Volume Using an Expression Pedal

When you depress the Expression Pedal, the volume increases. The volume decreases as you tilt the pedal back.

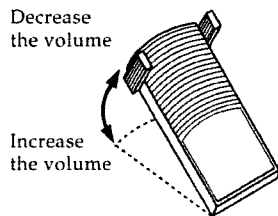

You can specify how the Expression Pedal will affect the sound when it is pressed (p. 111).



You can also specify whether the Expression Pedal will or will not control the volume during the recording of music data (p. 96).



Likewise you can specify whether the Expression Pedal will or will not control the volume during the playback of recorded music data (p. 97).



The volume of a song file that has not been created on an Atelier (SMF Song Files) cannot be controlled from the Expression Pedal.

Adding Decay to the Sound (Damper Pedal)

When you depress the Damper (Sustain) pedal, a decay effect will be added to the voices. While you continue depressing the damper pedal, notes will be sustained even if you release the keys.

By default the decay effect will be applied to the voices played on the Lower keyboard.

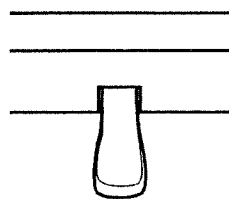

You can modify the setting so that decay is applied to notes played on the Upper keyboard (p. 109).



Decay cannot be added to the Solo voices.



Decay can not be applied to Bass voices played on the Lower keyboard (when the [To Lower] or [Bass Split] button indicators are lit).

Pitch Bend and Vibrato Effects

When you move the Pitch Bend/Vibrato lever to the left or right, you can obtain a smooth change in the pitch of the notes being played (Pitch Bend effect). Move the lever to the right to raise the pitch, and to the left to lower it. Also, when you push the lever away from you, a vibrato effect can be obtained.

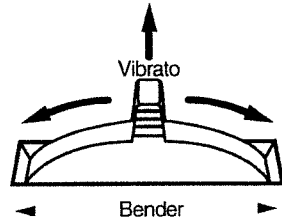

By default (immediately after the power is turned on) the Pitch Bend effect is added to the voices of all the sections being played on the Upper keyboard.



You can change the settings so that both the Pitch Bend and Vibrato effects are applied to the Lower keyboard voice or the voices on the Pedalboard (p. 109).



You can also adjust the range of the pitch which is shifted by the Pitch Bend lever (p. 109).



Please note that only the appropriate voices will allow vibrato to be added (p. 121).

Adjusting the Brightness of the Sound

Using the [Brilliance] slider, you can adjust the brightness of the sound. For a brighter sound, push the slider away from you. For a mellower sound, pull the slider toward you.

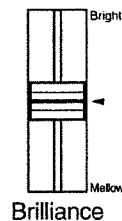

This setting is not stored in the Registration.

Using the Foot Switches

The instrument is provided with two Foot Switches, one on each side of the Expression Pedal.

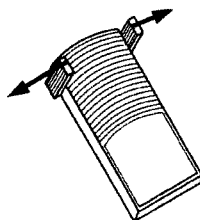

With the factory settings, the following functions are assigned to the left and right Foot Switches.

Right Foot Switch	Switch the Rotary effect between Fast / Slow
Left Foot Switch	Glide (an effect which momentarily lowers the pitch by a semi-tone, and you release the Foot Switch, the pitch will return to normal)

1. Press the right Foot Switch toward the right.

The Rotary effect will switch between “Fast” and “Slow” each time you press the Foot Switch.

2. Press the left Foot Switch toward the left.

While you are pressing the Foot Switch, the pitch will be temporarily lowered. When you release the Foot Switch, the pitch will return to normal.



You can also change the functions assigned to the left and right Foot Switches. Please refer to “Left/Right Foot Switch Assignment” (p. 108).



The Glide effect will only be applied to the keyboard section that has been specified as being the destination for the Pitch bend/Vibrato lever. Please refer to “Bender/Vibrato Destination” (p. 109).



If the Utility menu item Registration Shift is ON, the right Foot Switch will be dedicated to switching through the Registration buttons (p. 107).

Using the Registration Buttons

The AT-60R allows you to store sound settings and panel settings such as 8 in the Registration buttons. There are a total of twelve Registration buttons, and one set of panel settings can be stored in each, allowing you to register a total of 8 different panel settings. Each set of panel settings that has been stored in a Registration button is called a "Registration."

This provides a convenient way to change large numbers of panel settings during a performance, or to recall a complex panel setting.

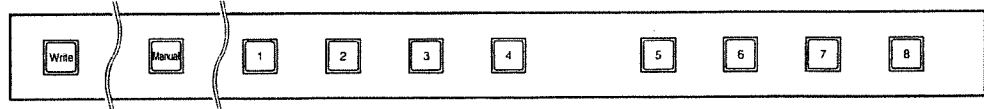

Settings that have been stored to Registration buttons [1]–[8] are remembered even if the power is turned off. If you wish to restore the settings stored in the Registration buttons to their factory settings, use the "Factory Reset" operation (p. 18).

Storing Registrations

- 1. Make all the panel settings that you wish to store.**
- 2. While holding down the [Write] button, press one of the Registration buttons [1] – [8].**

The panel settings will be stored in the selected Registration button.



With the settings of Registration buttons [1] – [8] considered as one set, a single floppy disk (2HD) can store up to 99 sets of data (p. 68).



For details on the settings that are stored in a Registration, refer to "Settings That Are Stored in the Registration Buttons" (p. 130).

Recalling a Registration

■ How to Recall a Registration

○ **Recalling voices and other panel settings**

1. Press a Registration button [1]–[8].

○ **Recalling settings for Rhythm and Automatic Accompaniment in addition to the panel settings**

1. Press and hold a Registration button [1]–[8] for several seconds.

■ Changing the Timing of Recalling Registrations

Settings for Rhythm play and Automatic Accompaniment are recalled when you continue holding a Registration button [1]–[8] for several seconds, but you can change this so that the settings are recalled the instant you press the button.

1. Press the [Utility] button located to the left of the display.
2. Use the [◀] and [▶] Menu buttons to select the “Arranger Update.”

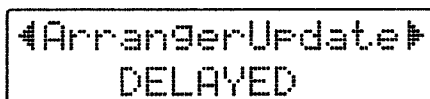

3. Press the [-] and [+] Value buttons to switch between “DELAYED” and “INSTANT.”

To return to the basic screen, press the [Utility] or [Display/Exit] button.

DELAYED When you press and hold a Registration button [1]–[8] for several seconds, the settings for Rhythm and Automatic Accompaniment will be recalled in addition to the panel settings. If you press and immediately release a Registration button [1]–[8], only the settings that are not related to Rhythm or Automatic Accompaniment will be recalled.

INSTANT Settings for Rhythm and Automatic Accompaniment will be recalled the instant that you press a Registration button [1]–[8].



You can change the timing of recalling the transpose setting when you press a Registration button [1]–[8]. For more information, please refer to page 111.

Automatically Registering When You Switch Panel Settings

When the [Manual] button is ON (lit), all panel settings you make will be stored automatically in the [Manual] button as they are made, thus updating the Registration that had been previously saved. If you change to a preset Registration [1]– [8], it is possible to return to the previous panel settings by pressing the [Manual] button.

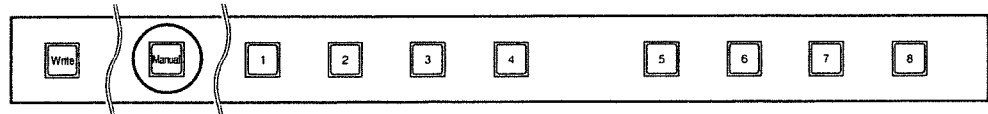

The settings stored in the [Manual] button will return to their default values when the power is turned off.

Assigning a Name to a Registration Set

When saving Registration sets, names like “REGIST-01 – 99” will be assigned by default, but you can assign a name that will help you later to identify the contents of the Registration set.

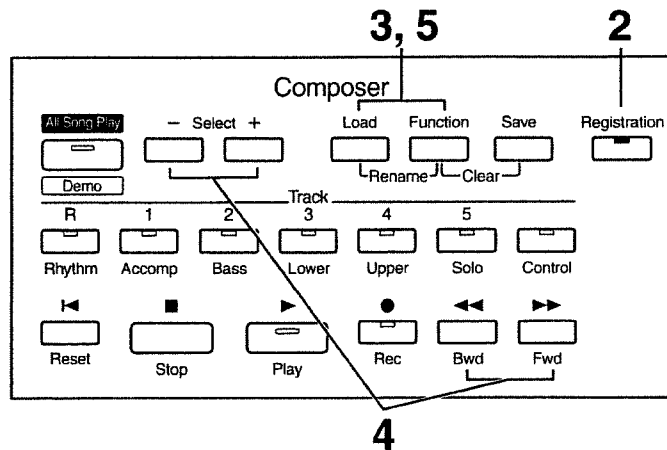

- 1.** Make sure that the disk drive contains a disk that was formatted (p. 81) by the AT-60R.
- 2.** Press the [Registration] button (indicator lights).
- 3.** Press the [Load] button and the [Function] button simultaneously.

Using the Registration Buttons

- 4. Use the [-] and [+] Composer Select buttons to move the cursor, and use the [Bwd]/[Fwd] buttons to select a character.**

```
REGIST-01    ---
Mem: █
```

The following characters can be selected.

space ! " # % & ' () * + , - . / : ; = ? ^ _ A B C D E F G H I J K L M N O P Q R S T U V W X
Y Z a b c d e f g h i j k l m n o p q r s t u v w x y z 0 1 2 3 4 5 6 7 8 9

You can also use the [Reset] button to delete a character, and the [Rec] button to insert a space.

- 5. When you have finished assigning the name, simultaneously press the [Load] button and the [Function] button once again.**

The Registration set in the AT-60R's internal memory has now been named.

```
REGIST-01    ---
Mem: My Regist
```

To return to the basic screen, press the [Registration] button or the [Display/Exit] button.



It is not possible to save during the process of assigning a name.

■ Copying Only the Name of a Registration

Here's how you can copy just the name of a Registration without copying its performance data.

- 1.** Insert the floppy disk that contains the Registration that you wish to copy into the disk drive.
- 2.** Press the [Registration] button to make the indicator light.
- 3.** Use the Composer Select [-] and [+] buttons to select the Registration whose name you wish to copy.
- 4.** Simultaneously press the [Load] button and [Function] button.

```
My Regist    USE  
Mem:
```

- 5.** Press the [Load] button.
Only the name of the Registration will be recalled.

```
My Regist    USE  
Mem:My Regist
```

- 6.** Simultaneously press the [Load] button and [Function] button.

Saving Registration Sets to a Floppy Disk (Save Button)

With the settings of Registration buttons [1] – [8] considered as one set, a single floppy disk can store up to 99 sets of data. We recommend that complex panel settings or Registrations you wish to keep be saved on disk. If AT-60R Registrations that you create are saved on a floppy disk, they can then be recalled later or recalled for use on another AT-60R.

- 1. Make sure that the disk drive contains a disk that was formatted (p. 81) by the AT-60R.**
- 2. If the [Registration] button indicator is not lit, press the [Registration] button (indicator lights).**
- 3. Use the [-] and [+] Composer Select buttons to select the number that you wish to save to.**

Numbers which have not been used in the saving operation will be displayed as “- - -”

```
REGIST-01    ---  
Mem:My Regist
```

To cancel the operation, press the [Registration] button.

- 4. Press the [Save] button to execute the save operation.**

When the Registration set is saved to the floppy disk, the indication of “- - -” will change to “USE.”

```
My Regist    USE  
Mem:My Regist
```

When saving is completed, the basic screen will reappear.

If you have assigned a name, the Registration set will be saved to floppy disk with that name.

● If the Following Screen Appears

If you press the [Save] button for a Registration number with the word “USE” indicated, the following message will appear.

```
OverwriteRegist?  
Yes:REC No:RST
```

○ If you wish to update the contents of the Registration data

- 1. Press the [Rec] button.**

The Registration will be rewritten.

- **If you wish to save the data without erasing the Registration data already on disk**

- 1. Press the [Reset] button to cancel the procedure.**

Rewriting of the Registration will be canceled.

- 2. Use the [-] and [+] Composer Select buttons to select a number for which “- - -” is displayed on the upper right of the screen.**

- 3. Press the [Save] button to save the Registration set.**

When the data has been saved, the basic display will reappear.

When the Registration set is saved to the floppy disk, the indication of “- - -” will change to “USE.”

Loading Previously Saved Registration Sets Into the AT-60R (Load Button)

Here's how to recall a previously saved Registration set from the floppy disk into the memory of the AT-60R.

Registrations can be selected in the following two ways.

- **Loading a Set of Registrations**

You can load a “set” (a collection of settings for Registration buttons [1] – [8]) from floppy disk.

- **Loading an Individual Registration**

You can load settings for an individual Registration button [1] – [8].



Be aware that when you load Registrations from a disk, the Registrations that were previously in internal memory will be lost. It is a good idea to save important Registrations to floppy disk (p. 68).

■ Loading a Set of Registrations

Registrations Sets saved to a floppy disk can be loaded back into the instrument.

- 1. Insert the floppy disk into the disk drive.**
- 2. Press the [Registration] button (indicator lights).**
- 3. Use the [-] and [+] Composer Select buttons to select the Registration set that you wish to load.**

```

My Regist      USE
Men:
  
```

To cancel the procedure, press the [Registration] button.

- 4. Press the [Load] button to execute loading.**

When loading is complete, the basic screen will reappear.

■ Loading an Individual Registration

You can load any desired individual Registration to any desired Registration button.

- 1.** Insert the floppy disk containing the Registration into the disk drive.
- 2.** Press the [Registration] button (indicator lights).
- 3.** Use the [-] and [+] Composer Select buttons to select the Registration set that you wish to load.
- 4.** Press the [Function] button.
- 5.** Use the [Bwd]/[Fwd] buttons to specify the Registration button number to be loaded.

```
Load One Regist  
from: 1  </>/REC
```

- 6.** Press the [Rec] button.
- 7.** Use the [Bwd] or [Fwd] buttons to specify the storage-destination Registration.

```
Load One Regist  
to: 1  </>/REC
```

- 8.** Press the [Rec] button.

The following display will appear.

```
Load Sure?  
Yes:REC No:RST
```

To cancel the procedure, press the [Reset] button.

- 9.** Press the [Rec] button once again.

When the Registration has been loaded, the basic screen will reappear.

Deleting a Previously Saved Registration Set

Here's how to delete a Registration set that was saved to a floppy disk.

- 1. Insert the floppy disk into the disk drive.**
- 2. Press the [Registration] button (indicator lights).**
- 3. Use the Composer Select [-] and [+] buttons to select the Registration set that you wish to delete.**
- 4. Simultaneously press the [Function] button and the [Save] button.**

The following display will appear.

```
Delete Regist?  
Yes:REC No:RST
```

To cancel the operation, press the [Reset] button.

- 5. If you are sure that you wish to delete the data, press the [Rec] button.**

When the Registration has been deleted, the basic screen will reappear.

When a Registration has been deleted, the indication of "USE" will change back to "---."

If you had assigned a name to the Registration set you deleted, the name will revert back to "REGIST-XX."

```
REGIST-01    ---  
Mem:
```

Using Registrations Created on an Earlier Model

Registrations created on an earlier model of the ATELIER series (AT-90/80/30) can also be used on newer models of the ATELIER series. When a Registration that was created on an earlier model is loaded into a newer model, it will be converted into a Registration for the newer model. By loading a Rhythm that was used on an earlier model from the included Music Style disk into the [Disk] button of this instrument, you can reproduce the Registration.

- 1. Insert the floppy disk that contains Registrations created on an earlier model of the ATELIER series.**
- 2. Press the [Registration] button (indicator lights).**
- 3. Use the Composer Select [-] and [+] buttons to select the desired Registration.**
- 4. Press the [Load] button.**
- 5. Use the [Bwd] / [Fwd] buttons to select the model on which the Registration was created.**

```
Convert Regist
AT-90    </>/REC
```

- 6. Press the [Rec] button to confirm the model on which the Registration was created.**

If the Rhythm used by the Registration is found in the internal memory of the AT-60R, the Registration will be loaded into internal memory.

When loading is complete, the basic screen will reappear.



If the Rhythms of the [Disk] button or the [World] button have been rewritten, there may be cases in which the Registration cannot be loaded correctly.

If the Rhythm used by the Registration is not found in internal memory, the number of the included Music Style disk that contains that Rhythm will be displayed (see the following screen). Make a note of the number of the Music Style disk.

The Number of Registration button which uses the Rhythm that is not found in the AT-60R's internal memory

```
ConvertRegist 8?  
Disk:1-20 /REC
```

Number of the included Music Style disk
("Number of the Music Style disk"- "Number of the Rhythm")

7. Press the [Rec] button.

If another Registration button also uses a Rhythm that is not found in internal memory, make a note of the Rhythm number within the disk, and press the [Rec] button. After you have been notified of all these points, Rhythms not found in internal memory will be replaced by similar Rhythms, and the Registration will be written into memory.

When loading is complete, the basic screen will reappear.

○ Loading a Rhythm Used by an Earlier Model from the Music Style Disk into the [Disk] Button

If you wish to use a Rhythm used by an earlier model of the ATELIER series with a Registration that you loaded, load the Rhythm from the Music Style disk into the [Disk] button.

8. Remove the floppy disk from the disk drive, and insert the Music Style disk.

9. Load the Rhythm whose number you noted in step 6 into the [Disk] button (p. 47).

Record and Playback Your Performance

The AT-60R's Composer allows you to record (in digital form) what you played on the instrument.

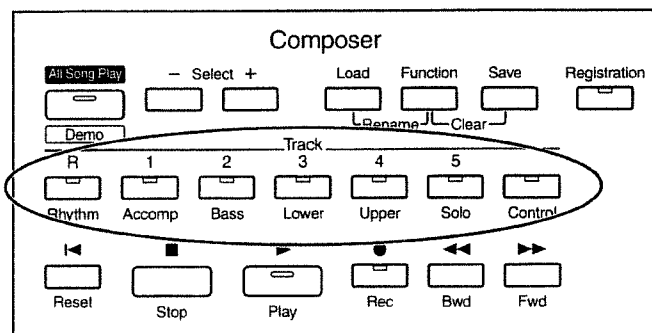

What is a Track?

The Composer operates like a tape recorder with the capability of recording seven separate tracks. You can record different kinds of performance data into each track:

Rhythm	Rhythm performances, Manual Drums, Manual Percussion
Accomp	Automatic Accompaniment (except Bass)
Bass	Pedal Bass Voice, Bass part of the Automatic Accompaniment
Lower	Lower Voice
Upper	Upper Voice
Solo	Solo Voice
Control	Panel operations, Expression Pedal operations



More information about the track assignments when playing commercial SMF data, please refer to page 78.

During recording, the control track will store the operations as follows.

○ Panel Operations

(Voice selections, Tempo changes, Rotary fast/slow etc.)

Newly recorded performance data will be added without erasing the previously recorded data. If you wish to erase all the recorded data and record new performance data, use the editing function "Erase" (erase performance data) to erase the data (p. 101).

○ Expression Pedal Operations

This will depend on the expression function in the Function menu. The way in which expression operations are recorded will depend on the setting of the "Exp. Source" item "Recording" in the Function menu.

PEDAL Expression pedal operations will be recorded.
If expression data has already been recorded, the previously recorded data will be erased as the new data is recorded.

COMPOSER Expression pedal operations will not be recorded.
If expression data has already been recorded, the previously recorded data will remain without being erased.

For details refer to "How the Expression Pedal Functions (Exp. Source)" (p. 96).

Recording Performances (Rec Button)

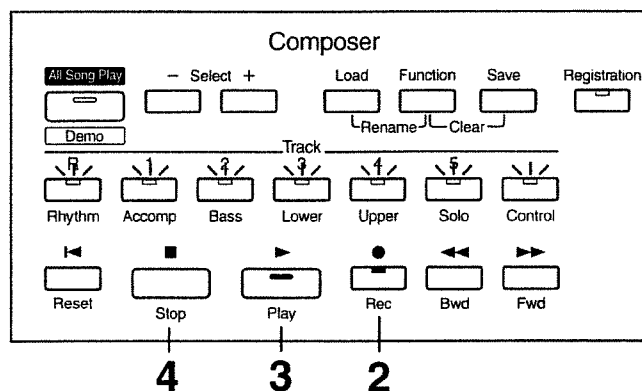

1. Select the panel settings needed for recording the performance.

If a floppy disk is in the disk drive, press the Eject button (p. 46) and remove the floppy disk.

2. Enter the recording standby mode by pressing the [Rec] button.

The [Rec] button's indicator will light. The [Play] button and all track indicators will flash.

3. Press the [Play] button to start recording.

When you press the [Play] button, the metronome will play two measures (bars) of count-in before recording begins.

If you wish to use Rhythm and Automatic Accompaniment as you record, press the [Start/Stop] button instead of the [Play] button to begin recording. Also, if the [Sync Start] button is lit (i.e., if Sync Start is ON), recording will begin the instant you play the Lower keyboard.

4. Press the [Stop] button when you have completed your recording.

The Track indicator where a performance song is recorded will change from a flashing to a constant light.

If you press the [Reset] button instead of the [Stop] button, the unit resets (returns) to the beginning of the song just recorded.



When you press the [Intro/Ending] button (or [Start/Stop] button) while recording a Rhythm performance or Automatic Accompaniment, the Rhythm performance and Automatic Accompaniment will stop. However, the recording itself will continue. Press the [Stop] button to stop recording.



The Play and Stop functions can both be assigned to one of the foot switches located on each side of the Expression Pedal. Each touch of the switch will alternate the operation between the Play and Stop functions (p. 108).



You can also choose to cancel the metronome count-in before recording starts (p. 95).

Record and Playback Your Performance



If you press the [Rec] button when a song has been selected from the floppy disk, the selected song will be completely loaded into the AT-60R and the Composer will enter into the recording standby mode.

If you wish to record a new song, press the [Stop] button to cancel the recording standby mode, use the [-] and [+] Composer Select buttons to first select "NEW SONG" before pressing the [Rec] button. Alternatively, eject the disk from the floppy disk drive before pressing the [Rec] button.

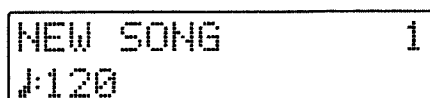

```
NEW SONG      1
♩:120
```

● If the Following Screen Appears

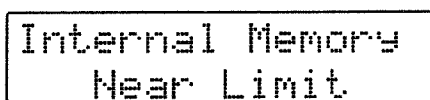

```
Internal Memory
Near Limit
```

When the instrument's memory is nearing capacity.

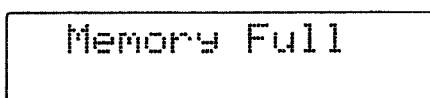

```
Memory Full
```

When recording was automatically canceled because the memory limit was reached.

Recording Each Part Separately

As you listen to the recorded performance, you can record each Part in sequence. In this method, each part is recorded one after another: first the Rhythm part, then the bass part, etc. If there are any previously recorded performances, you can listen to them as you record additional parts.

- 1. Select the panel settings needed for recording the performance.**
- 2. Use the [Bwd] / [Fwd] buttons to select the desired measure (bar) when you start recording.**

If you wish to start recording from the beginning of the song, press the [Reset] button.

- 3. Press the [Rec] button to enter the recording standby mode.**

The [Rec] button indicator will light, and the [Play] button and the track buttons of un-recorded tracks will blink.

The button indicators of tracks that are already recorded will light.

- 4. Press the [Play] button to start recording.**

When you press the [Play] button, the metronome will play two measures (bars) of count-in before recording begins. As you listen to the performance song previously recorded, record the Part into a new Track.

- 5. Press the [Stop] button when your recording is completed.**

The track button indicators for which performance data has been recorded will be lit.

Playing Back a Performance Song (Play Button)

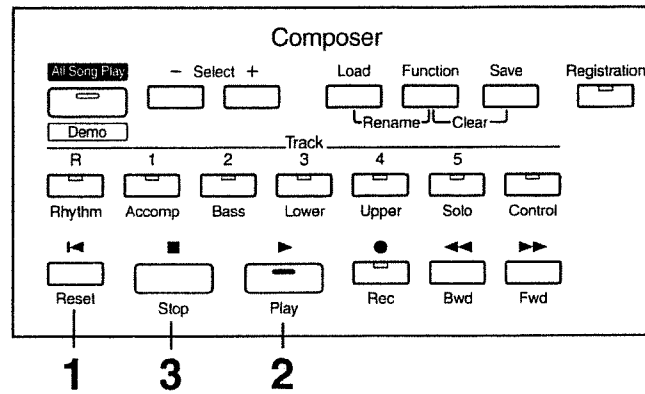

- 1.** Press the [Reset] button to return to the beginning of the first measure (bar).

The location at which playback will start will return to the beginning of measure 1. When you wish to play a performance song from a specific point, use the [Bwd] / [Fwd] buttons to select the desired measure (bar).

- 2.** Press the [Play] button to start playback.

After playback reaches the end of the performance, it will stop automatically.

- 3.** To stop playback at any point, press the [Stop] button.

If you press the [Reset] button instead of the [Stop] button, the unit resets (returns) to the beginning of the data.



If you press the [Play] button while holding down the [Stop] button, the metronome will play two measures (bars) of count-in before playback starts.



The [Play] and [Stop] functions can both be assigned to one of the foot switches located on each side of the Expression Pedal. Each touch of the switch will alternate the operation between the Play and Stop functions (p. 108).



You can specify whether or not the Expression Pedal will affect the playback and what you play while Atelier music data is being played back (p. 97).



If you use the Rhythm or Automatic Accompaniment immediately after having loaded and played back a song other than an Atelier performance song, such as SMF's, etc., the playback may not sound right (the voices may have changed, etc.) To prevent this from happening, press the [Reset] button before playback.



When a song other than an Atelier performance song (such as an SMF Song File) is loaded and played back, the Expression Pedal will have no effect on the playback volume.

Silencing a Specific Track — Track Mute

The button indicators for tracks in which performances were recorded will be lit. By turning off these track button indicators, you can temporarily silence the sound. This is referred to as “Track Mute.”

Example: Muting the Sound for Upper Part

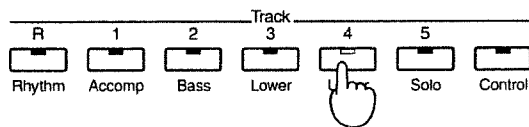

- 1. Press a track button whose indicator is lit to turn the light off.**
The track whose indicator was turned off will be muted (silenced).
- 2. Press the track button once again (indicator lights).**
The part that had been muted will return to normal and will be heard.

■ Track Assignments When Paying Commercial SMF Data

- When you playback without loading (p. 87, p. 89) the SMF data

Button	Channel
[R]	10
[1]	1
[2]	2
[3]	3
[4]	4
[5]	5, 6, 7, 8, 9, 11, 12, 13, 14, 15, 16

- When you first load and then playback the SMF data

Button	Channel
[R]	10
[1]	Performance data other than 2 and 10
[2]	2
[3]	Nothing (Performance data from the ATELIER series can be recorded)
[4]	Nothing (Performance data from the ATELIER series can be recorded)
[5]	Nothing (Performance data from the ATELIER series can be recorded)

Re-Recording

If you made a mistake in your performance during recording etc., you can re-record just a portion of the musical data in the track.



If you wish to re-record with different settings for voices, tempo, part balance, erase the recorded song (p. 80) and re-record again. If the Control track still contains data from before you re-recorded, the volume or sounds may change during playback.

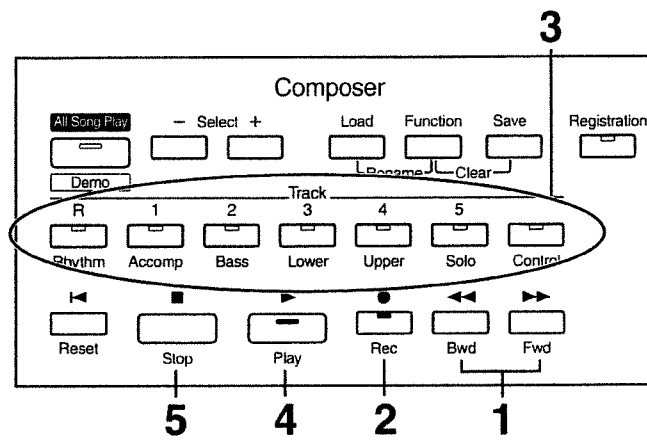

- 1.** Use the [Reset] button or the [Bwd] / [Fwd] buttons to move to the measure (bar) where you wish to start re-recording.
- 2.** Press the [Rec] button to enter into the recording standby mode.
The [Rec] button indicator will light, and the indicators of the [Play] button, the [Control] button and the track buttons of unrecorded tracks will flash. The track buttons of tracks already-recorded will light.
- 3.** Press the Track button which you wish to re-recording (indicator flashes).
The song data of the specified Track (with the exception of the Control Track) will be erased as new song data is recorded.
When the indicator of a Track is lit constantly, no song data has been recorded on that Track.
- 4.** Press the [Play] button to start recording.
When you press the [Play] button, the metronome will play two measures (bars) of count-in before recording begins.
- 5.** Press the [Stop] button when your recording is completed.
The button indicators of tracks which were re-recorded will change from flashing to being constantly lit.



If you wish to keep the existing Expression Pedal data, and record only the panel operations, you can make settings to prevent the operation of the Expression Pedal from being recorded (p. 96).



You can use punch-in recording (p. 91) to re-record only the area that you specify.

Erasing a Performance Song (Clear)

If you wish to discard your recording and re-record from the beginning, or if you wish to record a new performance, you must erase the previously-recorded data.

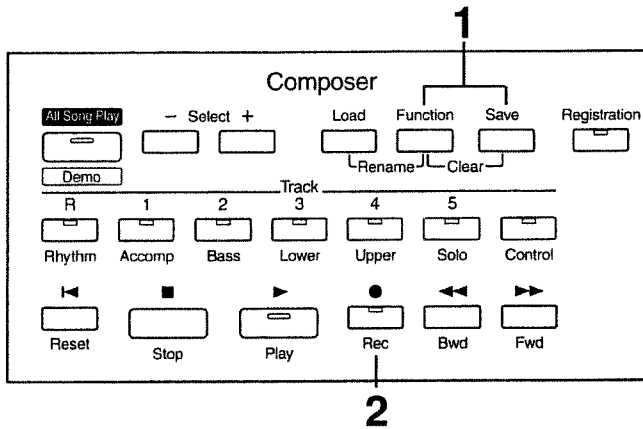

- 1. Press the [Function] and [Save] buttons simultaneously.**

The following message, asking you to confirm your choice, will be displayed.

```
Clear Song Sure?  
Yes:REC No:RST
```

To cancel the procedure, press the [Reset] button.

- 2. If you are sure that you wish to erase the song, press the [Rec] button.**

Formatting Disks

Before any floppy disk (new or used) can be used with the AT-60R it must first be formatted (prepared).

Floppy disks must first be "formatted" (initialized) before they can be used by the AT-60R to store data. "Formatting" is the process of erasing any data which may have been on the disk and making the format of the floppy disk match the format of the device. The AT-60R cannot use a floppy disk that has a format differing from its own format.



Formatting a disk will erase any data that may have been stored on it. Carefully check any previously used disk to be sure it doesn't contain any valuable data.

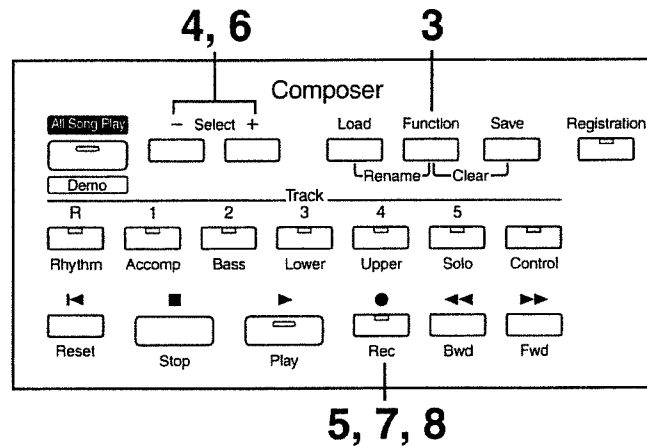

1. Make sure that the write protect tab of the floppy disk is in the "Write" (permit) position.

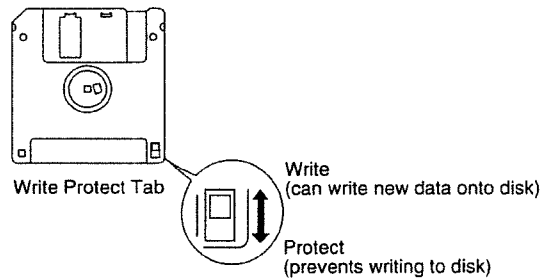

2. With the label of the floppy disk facing upward, insert it into the disk drive until it clicks into position.

The disk drive is located to the upper right of the AT-60R's keyboard.



Please DO NOT insert the floppy disk into the gap between the cabinet and the lid.

3. Press the [Function] button.

- 4.** Use the [-] and [+] Composer Select buttons to select “Disk Utility.”

```
Disk Utility ▣  
Yes:REC
```

- 5.** Press the [Rec] button.

- 6.** Use the [-] and [+] Composer Select buttons to select “Format Disk.”

- 7.** Press the [Rec] button.

The following message, asking you to confirm, will be displayed.

```
Format Sure?  
Yes:REC No:RST
```

To cancel the procedure, press the [Reset] button.

- 8.** Press the [Rec] button again to perform the Format.

While formatting is in progress, the following display will appear.

```
Formatting  
25% 00.....
```

When formatting is completed, the basic screen will reappear.



Never attempt to remove the floppy disk until formatting is complete.

Changing the Name of a Performance Song (Rename)

A name is automatically assigned to a performance song that you record. However, at some point you may wish to change the name to something more meaningful.

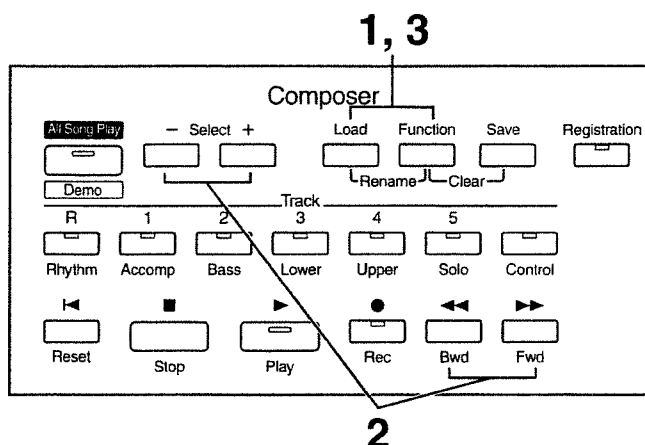

- 1. Press the [Load] and [Function] buttons simultaneously.**
- 2. Use the [-] and [+] Composer Select buttons to move the cursor, and use the [Bwd]/[Fwd] buttons to select a character.**

The following characters can be selected when changing a name:

space ! " # % & ' () * + , - . / : ; = ? ^ _ A B C D E F G H I J K L M N O P Q R S T U V W X
Y Z a b c d e f g h i j k l m n o p q r s t u v w x y z 0 1 2 3 4 5 6 7 8 9

To delete a character, press the [Reset] button. A space can be inserted by pressing the [Rec] button.

- 3. To confirm the new name, simultaneously press the [Load] and [Function] buttons once again.**

The new name is now inserted.

```

My Song
↓:180 #
  
```



It is not possible to save during the Rename procedure.



You cannot directly change or edit the name of a performance song stored on a disk. The song must first be loaded (p. 87) into the instrument, edited, and then saved to disk again.

Saving Performance Songs Onto Floppy Disk (Save Button)

The performance data that you recorded will disappear when the power of the AT-60R is turned off. If you wish to keep the performance data, you can save it on a floppy disk. If the performance data has never been saved to a floppy disk, a "☐" symbol will appear in the display. When the performance data is saved to a floppy disk, this symbol will no longer be displayed.

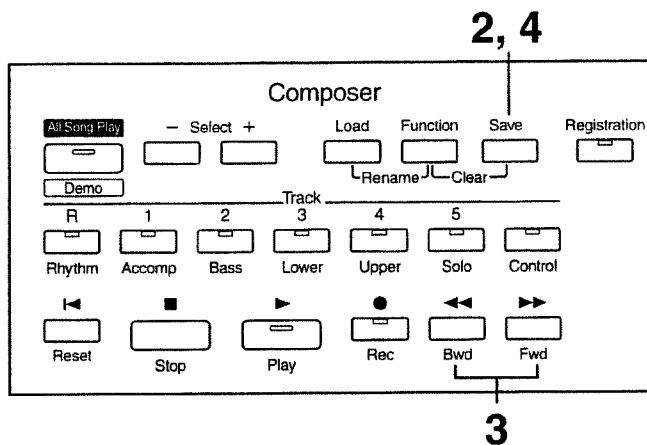
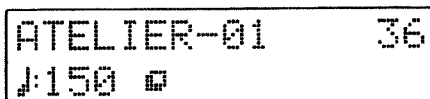

- 1.** Insert a floppy disk formatted (p. 81) on the AT-60R into the disk drive.
- 2.** Press the [Save] button to save the performance.
- 3.** Use the [Bwd] / [Fwd] button to select the format.

You can select either "ORIGINAL" or "SMF" format.

ORIGINAL Save data in Atelier format
SMF Save data in SMF format



4. Press the [Save] button to confirm the type of format.

While performance data is being saved to the floppy disk, the following display will appear.

```
ATELIER-01  36
Saving...
```



Music data that was saved in Atelier format cannot be played back correctly on instruments other than the Atelier series.



For a detailed explanation of the SMF format, refer to "Saving in SMF Format" (p. 86).

● If the Following Screen will Appear

If the floppy disk already contains performance data of the same name, the following display will appear.

```
Overwrite Song ?
Yes:REC No:RST
```

○ If you wish to update the contents of the performance data

- 1. Press the [Rec] button.**

○ If you wish to save the data without erasing the performance data already on disk you must rename the song

- 1. Press the [Reset] button to cancel saving.**
- 2. Change the name (p. 83), and perform the Save procedure once again.**

■ Saving in SMF Format

Since the AT-60R allows you to save data in SMF format, performance data you've recorded using the Atelier's organ sound generator can easily be edited on an external sequencer.

Alternatively, since the sound generator of the Atelier organ can be controlled from MIDI In, data that was saved in SMF format can be played back on your external sequencer, thus playing the Atelier via MIDI.



SMF (Standard MIDI File) is a data format that was created as a standardized way to exchange music data between devices made by different manufacturers.

- 1. Insert a floppy disk that was formatted by the AT-60R (p. 81) into the floppy disk drive.**
- 2. Press the [Save] button.**
- 3. Use the [Bwd] / [Fwd] buttons to select "SMF" as the format.**

```
Save Format
SMF  */*/SAVE
```

- 4. Press the [Save] button to confirm the type of format.**

The data will be saved in SMF format.

```
My Song 1
↓:180
```



Saving performance data in SMF format (SMF) requires a longer time than saving it in Atelier format (ORIGINAL).



Performance data saved by the AT-60R will not playback correctly on any device other than the ATELIER series.



If you edit the data on an external sequencer, save it in SMF format 1. Song data saved in SMF format 0 will not be played back correctly.

Loading Performance Songs Into the AT-60R

To edit (p. 99) or re-record a performance song that is stored on a floppy disk, you must first load that song into the instrument.

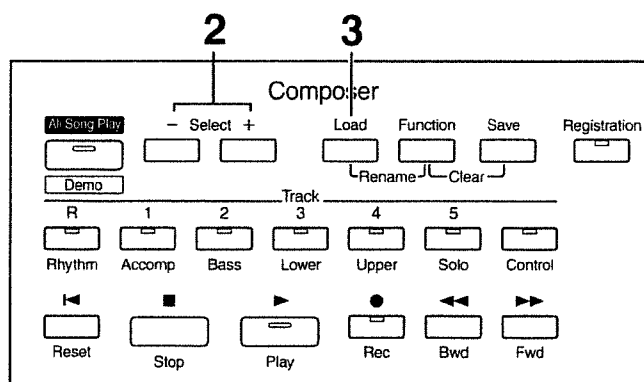

- 1.** Insert the correct floppy disk into the disk drive.
- 2.** Press the [-] or [+] Composer Select button to select the performance song you wish to load.
- 3.** Press the [Load] button to carry out the load operation.

● If the Following Screen will Appear

The message below is shown when the performance song in the unit has not been saved to disk.

```

Clear Song Sure?
Yes:REC No:RST
  
```

○ If you wish to erase the performance song

- 1.** Press the [Rec] button.
- If you wish to save the performance song on a floppy disk
- 1.** Press the [Reset] button to cancel the procedure.
 - 2.** Save the song on a floppy disk (p. 84).

Record and Playback Your Performance



If you load a song other than Atelier performance songs (SMF song files, etc.), the Rhythm (drum) Part will automatically be loaded into the Rhythm track, and the other Parts loaded into the Accomp and Bass tracks.



If loading is canceled because the memory limit has been reached, the following message will be displayed:

Memory Full

■ Layering a New Recording onto SMF Format Music Data

You can load SMF format music data into the AT-60R and play it back while you record your own playing as an additional layer.

- 1. Insert a floppy disk containing SMF format music data into the floppy disk drive.**
- 2. Use the Composer select [-] [+] buttons to select the music data that you wish to load into the AT-60R.**
- 3. Press the [Load] button.**

The selected music data will be loaded.

When SMF format music data is loaded into the AT-60R, it will be stored in the following tracks (p. 78).

Rhythm The Rhythm performance (channel 10)

Bass The Bass performance (channel 2)

Accomp Performance data other than the Rhythm and Bass (except channels 2 and 10)

- 4. Make the panel settings that you wish to record.**
- 5. Use the [Bwd] button and [Fwd] button to move to the measure at which you wish to begin recording.**
- 6. Press the [Rec] button to enter record-ready mode.**

The [Rec] button indicator will light, and the [Play] button indicator will blink.
- 7. Press the [Play] button to begin recording.**

As you record, the music data that was loaded into the AT-60R will play back.
- 8. Press the [Stop] button to stop recording.**



The performance data you recorded can be saved on a floppy disk (p. 84).



Commercially sold music files can also be loaded into the AT-60R, but for reasons of copyright protection, cannot be saved in SMF format.

Playing Back Performance Songs Stored on Floppy Disk

In addition to playing back the music you recorded on the instrument and saved to a floppy disk, AT-60R also lets you enjoy a wide variety of commercially available song files, such as defined below.

SMF Song Files

The Standard MIDI File (SMF) format was designed to provide a means for exchanging performance data among a wide variety of devices. In addition to the song files described earlier, the AT-60R is also capable of playing back any Standard MIDI File compatible with the GM or GS formats.



If you wish to purchase SMF music data, please contact the dealer where you purchased the AT-60R.

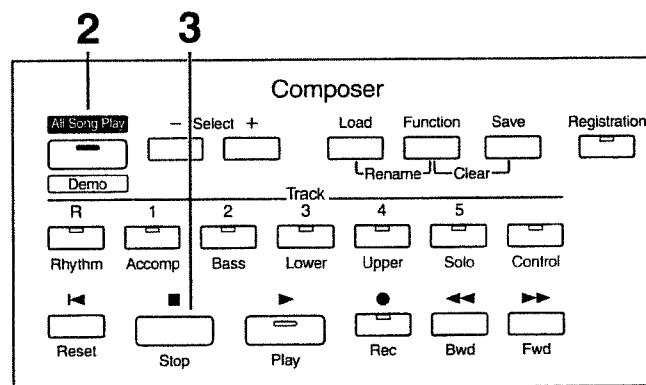

1. Insert the correct floppy disk into the disk drive.

When the performance song loaded from a disk is a Standard MIDI File, " :♩:" will be displayed after the file name.

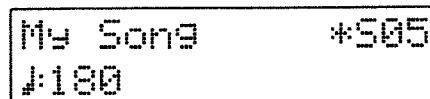

2. When you wish to play back all the performance songs in order, press the [All Song Play/Demo] button.



When you only wish to play back one song, use the [-] and [+] Composer Select buttons to select the song, then press the [Play] button.

3. To stop playback, press the [Stop] button.

Erasing Performance Songs Stored on Disk

Follow the steps below to erase a performance song that was saved onto a floppy disk.

- 1. Insert the floppy disk into the disk drive.**
- 2. Press the [Function] button.**
- 3. Press the [-] or [+] Composer Select button to select "Disk Utility."**

```
Disk Utility 
Yes:REC
```

- 4. Press the [Rec] button.**
- 5. Press the [-] or [+] Composer Select button to select "Delete Song."**

```
 Delete Song
Yes:REC No:RST
```

- 6. Press the [Rec] button.**
To cancel the procedure, press the [Reset] button.
- 7. Using the [Bwd]/[Fwd] buttons, select the performance song to be erased.**

- 8. Press the [Rec] button.**

You will see the following:

```
ATELIER-01  S01
Del Sure?REC/RST
```

- 9. To go ahead with the erasure, press the [Rec] button again.**

When erasing is completed, the basic screen will reappear.

Re-Recording Part of Your Performance — Punch-in Recording

After you have recorded a performance, you can re-record a specified portion of the performance. With this method, you listen to the recorded performance, and re-record just the desired area. This recording method is called “Punch-in Recording.”

To use Punch-in Recording, you can...

- Turn on the Function menu item “Punch In/Out,” and specify the area that you wish to re-record.



- Use the Composer to play back the recorded performance, and re-record just a specific portion.

○ Specify the Area that You Wish to Re-record

- 1.** Press the [Function] button.
- 2.** Use the [-] and [+] Composer Select buttons to select “Punch In/Out.”

```

Punch In/Out
Yes: REC
  
```

- 3.** Press the [Rec] button.
- 4.** Use the [-] and [+] Composer Select buttons to select “ON.”

```

Punch In/Out
ON  </>/REC
  
```

ON Punch-in Recording
OFF Normal Recording

- 5.** Press the [Rec] button.
- 6.** Use the [Bwd] / [Fwd] button to select “from” (the first measure that you wish to re-record).

```

Punch I/O Meas.
from: 1 </>/REC
  
```

Record and Playback Your Performance

- 7.** Press the [Rec] button.
- 8.** Use the [Bwd] / [Fwd] button to select “for” (the number of measures that you wish to re-record).

Punch I/O Meas.
for: 4 

- 9.** Press the [Function] or [Display/Exit] button.

○ Re-record While You Listen to the Song

- 10.** Enter the recording standby mode by pressing the [Rec] button.
- 11.** Press the Track button which you wish to re-recording (indicator flashes).
- 12.** Press the [Play] button.

When you press the [Play] button, the metronome will play two measures (bars) of count-in before recording begins.

When you reach the first measure of the specified area, recording will begin. When the specified area ends, recording will end, and playback will resume.

- While the song is playing back or recording, the [Rec] button’s indicator will be lit as follows.

While the performance is playing back	The [Rec] button’s indicator will flash
While you are re-recording	The [Rec] button’s indicator will light constantly



When recording has ended for the specified area and the data is once again playing back, the [Rec] button’s indicator will resume flashing.

- 13.** Press the [Stop] button to stop the song.

The indicator of the track button which recorded the performance will light.



When Punch-in Recording ends, the Function menu item “Punch In/Out” will return to OFF (normal recording). If you wish to use punch-in recording once again, you must make the “Punch In/Out” setting once again.

Repeatedly Layering Performances Over a Region — Loop Recording

You can repeatedly record over a specified area to build up multiple performances. This type of recording is called “Loop Recording.”

This recording method is convenient when you wish to layer drum sounds individually for the Rhythm part.



“Loop Recording” can be used only when recording the Rhythm part.

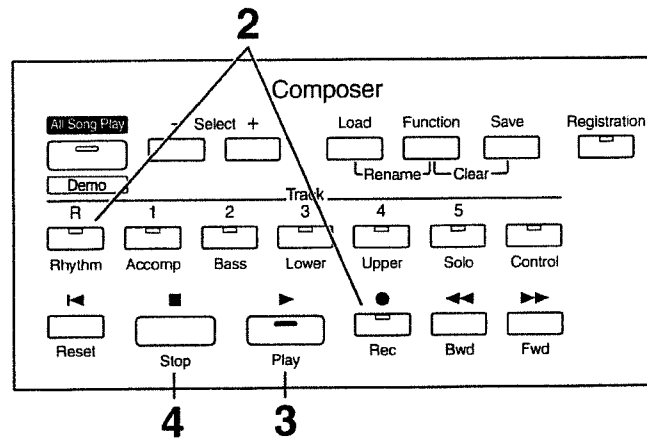

1. Press the [Manual Drums] button or the [Manual Perc] button to select a Drum Set or Sound Effect Set (p. 33).
2. Enter the recording standby mode by pressing the [Rec] button and [Rhythm] button.

The [Play] button and [Rhythm] button indicators will flash.

3. Press the [Play] button.

When you press the [Play] button, the metronome will play two measures (bars) of count-in before recording begins.

When recording reaches the end of the measure, it will return to the beginning of the measure, allowing you to continue recording to layer additional notes.



You can change the number of measures over which Loop Recording will occur. Please refer to “Changing the Number of Measures for Loop Recording” (p. 94).

4. Press the [Stop] button to stop recording.

Record and Playback Your Performance

○ Changing the Number of Measures for Loop Recording

With the initial settings, Loop Recording will occur over one measure. In the Function menu you can change the number of measures over which Loop Recording will occur.

- 1. Press the [Function] button.**
- 2. Use the [-] and [+] Composer Select buttons to select “Loop Recording.”**



The Number of Measures for Loop Recording

- 3. Use the [Bwd] button and [Fwd] button to select the number of measures for Loop Recording.**
- 4. Press the [Function] or [Display/Exit] button.**

The number of measures for Loop Recording has now been specified.

Use the procedure for Loop Recording to begin recording.

Settings for the Composer (Function Button)

Count-In Recording

This setting (ON/OFF) determines whether or not a metronome count-in (2 measures) will be heard after pressing the [Play] button on recording. (The count-in helps you to establish the tempo before you begin playing).

1. Press the [Function] button.
2. Using the [-] and [+] Composer Select buttons, select "Count-In Rec."

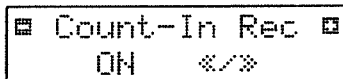

Count-In Rec
ON

3. Use the [Bwd]/[Fwd] buttons to turn it ON or OFF.

ON A two-measure count will sound before recording
OFF No count will sound before recording

To return to the basic screen, press the [Function] button or the [Display/Exit] button.

Changing the Metronome Setting

This setting determines whether or not the metronome will sound.

1. Press the [Function] button.
2. Using the [-] and [+] Composer Select buttons, select "Metronome."

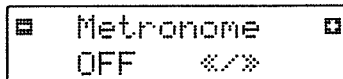

Metronome
OFF

3. Use the [Bwd]/[Fwd] buttons to select OFF, REC, or ON.

OFF Not heard at all
REC Heard only while recording
ON Heard constantly

To return to the basic screen, press the [Function] button or the [Display/Exit] button.

Metronome Volume

Carry out the steps below to adjust the volume of the metronome.

1. Press the [Function] button.
2. Using the [-] and [+] Composer Select buttons, select "Metronome Vol."

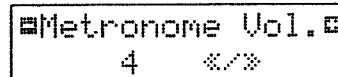

Metronome Vol.
4

3. Press the [Bwd]/[Fwd] buttons to select the desired volume level (1-10).

Increasing the value will raise the volume of the metronome.

To return to the basic screen, press the [Function] button or the [Display/Exit] button.

Changing the Sound of the Metronome

You can choose one of 4 different sounds for the metronome.

1. Press the [Function] button.
2. Use the [-] and [+] Composer Select buttons to select "Metronome Sound."

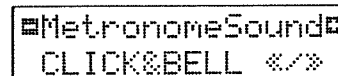

MetronomeSound
CLICK&BELL

3. Press the [Bwd] / [Fwd] buttons to select the type of sound for the metronome.

CLICK&BELL Conventional metronome sound
ELECTRONIC Electronic metronome sound
VOICE ENG. Human voice (English)
VOICE JPN. Human voice (Japanese)

To return to the basic screen, press the [Function] button or the [Display/Exit] button.

→ This setting remains stored in memory even while power is turned off.

Settings for the Composer (Function Button)

Setting the Beat

This setting determines the beat to be used when recording performance songs.

Numerator 1 or higher (denominator x 2-1)
Denominator 2, 4, 8, 16

1. Press the [Function] button.
2. Using the [-] and [+] Composer Select buttons, select "Beat."

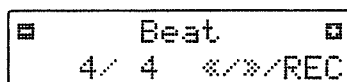

3. Use the [Bwd]/[Fwd] buttons to set the numeric value for the numerator.
4. To set the denominator, use the [Rec] button to move the cursor from the numerator to the denominator.
Press the [Rec] button again if you wish to return to the numerator.
5. Use the [Bwd]/[Fwd] buttons to set the numeric value for the denominator.

To return to the basic screen, press the [Function] button or the [Display/Exit] button.

- * When recording Rhythm performances or Automatic Accompaniment, the beat is set automatically.
- * You cannot change the beat of previously recorded songs.

How the Expression Pedal Functions (Exp. Source)

Specify how the Expression Pedal will function when your performance is being recorded and when ATELIER song files are being played back.

■ Function During Recording

Specify whether Expression Pedal operations will be recorded or not while your performance is being recorded.

1. Press the [Function] button.
2. Press the [-] or [+] Composer Select button to select "Exp. Source."

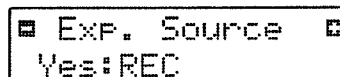

3. Press the [Rec] button.
4. Press the [-] or [+] Composer Select button to select "Recording."
5. Use the [Bwd]/[Fwd] buttons to specify the pedal function.

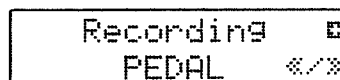

PEDAL	Expression Pedal movements will be recorded. The previous recording will be erased as new songs are recorded.
COMPOSER	Expression Pedal movements will not be recorded. The previous data will remain without being erased.

To return to the basic screen, press the [Function] button.

■ Function During Playback

You can specify whether or not the Expression Pedal will function while ATELIER song files are being played back.

1. Press the [Function] button.
2. Press the [-] or [+] Composer Select button to select "Exp. Source."

```

┌ Exp. Source ─┐
│ Yes:REC      │
└──────────┘
    
```

3. Press the [Rec] button.
4. Press the [-] or [+] Composer Select button to select "Playback."
5. Press the [Bwd]/[Fwd] buttons to specify the pedal function.

```

┌ Playback ─┐
│ PEDAL+COMP </> │
└──────────┘
    
```

PEDAL	The Expression Pedal will function. The Expression Pedal recording within the song file will be ignored.
COMPOSER	The Expression Pedal will not function. The Expression Pedal recording within the song file will be effective.
PEDAL+COMP	The Expression Pedal will function. Expression Pedal recording within the song file will also be effective.

To return to the basic screen, press the [Function] button.

Muting Individual Channels of Performance Data

You can mute (silence) individual channels of performance data of SMF data.

* It is not possible to mute the performance that you play on the AT-60R (except for the Rhythm and Automatic Accompaniment).

1. Press the [Function] button.
2. Use the Composer Select [-] [+] buttons to select "Ch.Mute."
3. Press the [Bwd] / [Fwd] buttons to select the channel that you wish to mute.

From the left, these are "1 Ch. (channel 1), 2 Ch. ... 15 Ch., and 16 Ch."

```

┌ Ch. Mute </> / REC ─┐
│ 1234567890123456 ─┐
└──────────┘
    
```

4. Press the [Rec] button.

```

┌ Ch. Mute </> / REC ─┐
│ -234567890123456 ─┐
└──────────┘
    
```

The number will change to "-", indicating that the corresponding channel has been muted.

5. Once again press the [Rec] button, and muting will be canceled.

To return to the basic screen, press the [Function] button or the [Display/Exit] button.

* Channel mute will be defeated when you perform the following operations.

- Use the Composer Select [-] and [+] buttons to select different performance data.
- Press the [All Song Play/Demo] button to play performance data.

Switching the Display of Lyrics On (Displayed) or Off (Not Displayed)

Some music files have Lyrics included and these Lyrics can be displayed on the screen. You can turn on or off the lyrics display of such music data.

1. Press the [Function] button.
2. Use the [-] and [+] Composer Select buttons to select "Lyric."

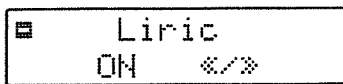

3. Press the [Bwd] / [Fwd] buttons to switch the lyric display "ON (displayed)" or "OFF (not displayed)."

To return to the basic screen, press the [Function] button.

* If you press a voice select button etc. while playing back music files that contains lyrics, the display screen will switch, and the lyrics will no longer be displayed. To re-display the lyrics, press the [Play] button once again.

Edit Menu (Editing Song Files)

Song files that you record can be edited using five different functions.

The following editing functions are provided.

Delete measure	(p. 99)
Delete Track	(p. 100)
Erase	(p. 101)
Copy	(p. 102)
Quantize	(p. 103)

* Once you edit data, it cannot be restored to its original condition. As a precaution against accidents, we recommend that you save your song to a floppy disk before you edit it.

Delete Part of the Recorded Song (Delete Measure (Bar))

This function lets you delete specified measures (bars) of the song from all tracks. When any part of the song file is deleted, subsequent recording will be moved forward to fill the gap.

Example: To delete measures (bars) 5-8

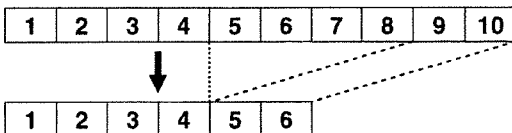

1. Press the [Function] button.
2. Use the [-] and [+] Composer Select buttons to select "Edit Menu."

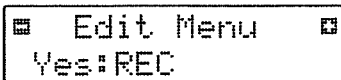

3. Press the [Rec] button.
4. Use the [-] and [+] Composer Select buttons to select "Delete Measure."

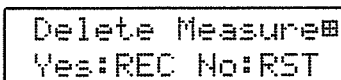

5. Press the [Rec] button.
6. Use the [Bwd]/[Fwd] buttons to specify "from" (the delete start measure).

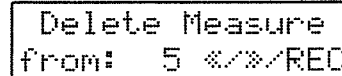

7. Press the [Rec] button.
8. Use the [Bwd]/[Fwd] buttons to specify "for" (number of measures from the delete start measure).

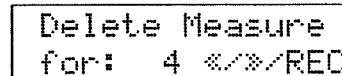

If you wish to delete from a certain measure (bar) to the last measure (bar), set for "ALL".

9. To execute the delete operation, press the [Rec] button once again.

The following screen will appear.

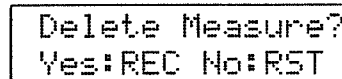

To cancel the operation, press the [Reset] button.

10. Press the [Rec] button to start deleting the measure.

When the recording has been deleted, the basic screen will reappear.

Delete the Recording from a Track (Delete Track)

This function lets you delete the recording from a track that you specify.

What is a Track?

The AT-60R has seven tracks. These tracks record the following performance data.

Rhythm	Rhythm performance, Manual Drums, Manual Percussion
Accomp	Automatic Accompaniment (except Bass and Rhythm performance), SMF data (except Bass and Rhythm performance)
Bass	Pedal Bass voice, Bass part of the Automatic Accompaniment, Bass part of the SMF data
Lower	Lower voice
Upper	Upper voice
Solo	Solo voice
Control	Panel operations (ex.: switching the buttons), Expression pedal operations, Part Balance Volume

* SMF data (except for data that was saved by the ATELIER series) stores the Rhythm track in channel 10, and the remaining musical data in the Accomp and Bass tracks (p. 78).

1. Press the [Function] button.
2. Use the [-] and [+] Composer Select buttons to select "Edit Menu."
3. Press the [Rec] button.
4. Use the [-] and [+] Composer Select buttons to select "Delete Track."

```

┌ Delete Track ─┐
│ Yes:REC No:RST │
└────────────────┘
    
```

5. Press the [Rec] button.

The following screen will appear.

```

Delete ⏪/⏩/REC
Track : RHYTHM
    
```

6. Use the [Bwd]/[Fwd] buttons to select the track that you wish to delete.

Settings: RHYTHM, ACCOMP, BASS, LOWER, UPPER, SOLO, CONTROL

7. Press the [Rec] button.

The following display will appear.

```

Delete Track?
Yes:REC No:RST
    
```

To cancel the operation, press the [Reset] button.

8. Press the [Rec] button once again to execute the Delete Track function.

When the recording has been deleted, the basic screen will reappear.

Erase Recording (Erase)

You can erase a specified portion of the performance in a specified area without making the song shorter. This is called the "Erase" function.

As an alternative to the method of erasing all performance data in a specified area, you can erase the following contents of the performance.

ALL	All recording
NOTE	Notes played on the keyboard
CONTROL	Panel operations, Part Balance Volume
EXPRESSION	Expression pedal recording
VOICE	Voice settings
TEMPO	Tempo setting

Example: Erasing measures (bars) 5-8

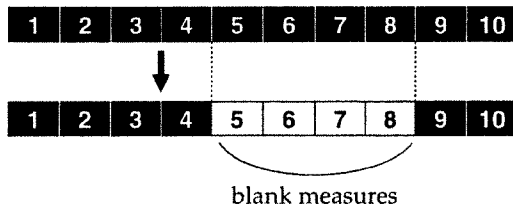

1. Press the [Function] button.
2. Use the [-] and [+] Composer Select buttons to select "Edit Menu."
3. Press the [Rec] button.
4. Use the [-] and [+] Composer Select buttons to select "Erase Event."

```

Erase Event
Yes:REC No:RST
    
```

5. Press the [Rec] button.
6. Use the [Bwd]/[Fwd] buttons to select the data to be erased.

```

Erase  $\langle \rangle$ /REC
Event:ALL
    
```

Settings: ALL (All recording), NOTE (Notes played on the keyboard), CONTROL (Panel operations, Part Balance Volume), EXPRESSION (Expression pedal recording), VOICE (Voice settings), TEMPO (Tempo setting)

7. Press the [Rec] button.
8. Use the [Bwd] / [Fwd] buttons to select the track whose recording you wish to delete.

If you have selected EXPRESSION and TEMPO as the type of recording to be erased, the Track selection will not be available because the expression control recording is common to all tracks.

```

Erase  $\langle \rangle$ /REC
Track: RHYTHM
    
```

Settings: ALL, RHYTHM, ACCOMP, BASS, LOWER, UPPER, SOLO

If you select "ALL", the recording will be erased from all tracks.

9. Press the [Rec] button.
 10. Use the [Bwd] / [Fwd] buttons to specify "from" (erase start measure).
 11. Press the [Rec] button.
 12. Use the [Bwd] / [Fwd] buttons to specify "for" (number of measures from the erase start measure).
- If you wish to erase to the last measure (bar), set "for: ALL."
13. Press the [Rec] button.

The following screen will appear.

```

Erase Event?
Yes:REC No:RST
    
```

To cancel the operation, press the [Reset] button.

14. Press the [Rec] button once again to execute the Erase function.
- When erasure is complete, the basic screen will reappear.

Edit Menu (Editing Song Files)

Copy Recording (Copy)

This function lets you copy a portion of recorded song to a different measure (bar) location in the same track.

* If a recording already exists at the copy destination, it will be erased.

Example: If you wish to copy measures (bars) 5-7 to measure (bar) 8

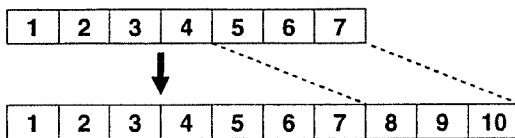

1. Press the [Function] button.
2. Use the [-] and [+] Composer Select buttons to select "Edit Menu."
3. Press the [Rec] button.
4. Use the [-] and [+] Composer Select buttons to select "Copy."

```
⊠      Copy      ⊠  
Yes:REC No:RST
```

5. Press the [Rec] button.
The following screen will appear.

```
Copy  </>/REC  
Track : ALL
```

6. Use the [Bwd]/[Fwd] buttons to select the track whose recording you wish to copy.

Settings: ALL, RHYTHM, ACCOMP, BASS, LOWER, UPPER, SOLO, CONTROL

If you select "ALL", the recording in all the tracks will be copied.

7. Press the [Rec] button.
8. Use the [Bwd] / [Fwd] buttons to specify "from" (copy start measure).

```
Copy  </>/REC  
from:  5
```

9. Press the [Rec] button.
10. Use the [Bwd] / [Fwd] buttons to specify "for" (number of measures from the copy start measure).

```
Copy  </>/REC  
for:   3
```

To specify until the last measure (bar), set "for: ALL".

11. Press the [Rec] button.
12. Use the [Bwd] / [Fwd] buttons to specify "to" (copy destination measure).

```
Copy  </>/REC  
to:   8
```

If you select "END," the data will be copied following the end of the last measure.

13. Press the [Rec] button.
14. Use the [Bwd] / [Fwd] buttons to specify "time" (number of times to copy the data).

```
Copy  </>/REC  
time:  1
```

15. Press the [Rec] button.
The following screen will appear.

```
Copy Sure?  
Yes:REC No:RST
```

To cancel the operation, press the [Reset] button.

16. To execute the Copy function, press the [Rec] button once again.
When copying is complete, the basic screen will reappear.

Correct Timing Inaccuracies (Quantize)

Quantize is a function that corrects the timing of notes to a specified resolution.

For example even if you intend to play at quarter-note timing, the notes may be slightly earlier or later than precise quarter-note intervals. In such cases, you can quantize to quarter note (1/4) timing to adjust the timing of the notes to precise quarter-note intervals.

1. Press the [Function] button.
2. Use the [-] and [+] Composer Select buttons to select "Edit Menu."
3. Press the [Rec] button.
4. Use the [-] and [+] Composer Select buttons to select "Quantize."

```

┌─ Quantize
│ Yes:REC No:RST
└─
    
```

5. Press the [Rec] button.
The following screen will appear.

```

Quantize </>/REC
Track : RHYTHM
    
```

6. Use the [Bwd]/[Fwd] buttons to select the track whose recording you wish to quantize.

Settings: ALL, RHYTHM, ACCOMP, BASS, LOWER, UPPER, SOLO

If you select "ALL", the recording in all the tracks will be quantized.

7. Press the [Rec] button.
8. Use the [Bwd] / [Fwd] buttons to specify "from" (quantize start measure).
9. Press the [Rec] button.
10. Use the [Bwd] / [Fwd] buttons to specify "for" (number of measures from the quantize start measure).

To specify the recording to the last measure (bar), set "for" ALL".



11. Press the [Rec] button.
12. Use the [Bwd] / [Fwd] button to specify "Res" (timing to which notes will be adjusted).



```



Quantize </>/REC
Res: ♩
    
```

"Res" (timing to which notes will be adjusted) can be set to the following values.

	
Half note	Quarter note

	
Quarter note triplet	8th note

	
8th note triplet	16th note

	
16th note triplet	32nd note

13. Press the [Rec] button.
The following display will appear.

```

Quantize Sure?
Yes:REC NO:RST
    
```

To cancel the operation, press the [Reset] button.

14. To execute the Quantize function, press the [Rec] button once again.
When quantization is completed, the basic screen will re-appear.

Adjusting the Effects

You can customize the Reverb, Sustain and Rotary effects by adjusting their values. The effects values are available for change in the following five menus:

Reverb Type	(p. 104)
Reverb Depth	(p. 105)
Sustain Length	(p. 105)
Rotary Speed	(p. 105)
Rotary Color	(p. 105)

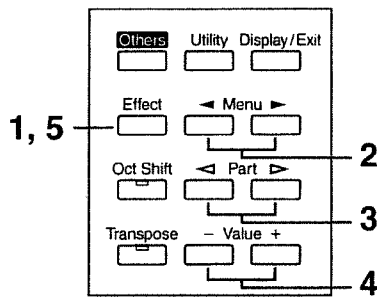

1. Press the [Effect] button.
2. Use the [◀] and [▶] Menu buttons to select the desired Menu.
3. When adjusting “Reverb Depth” or “Sustain Length,” use the [◀] and [▶] Part buttons to select the desired Part.
4. Use the [-] and [+] Value buttons to set the desired value.
5. To return to the basic screen, press the [Effect] or [Display/Exit] button.
The basic screen will reappear.

Changing the Reverb Type

You can select from the following eight types of Reverb:

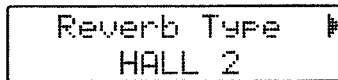

Display	Description
ROOM 1	Reverberation of a small room
ROOM 2	Reverberation of a small club
ROOM 3	Reverberation of a large room
HALL 1	Reverberation of a large concert hall
HALL 2	Reverberation of a small concert hall
PLATE	A bright, metallic Reverberation
DELAY	An echo-like sound repeated several times
PAN DELAY	Similarly to the above but where the sound is panned between the left and right speakers

* It is not possible to modify the delay time (delay interval) when “DELAY” or “PAN DELAY” are selected.

Changing the Reverb Depth

The depth of the Reverb can be set (0-10) for the following Parts. You can make independent settings for each Part.

```

┌ Reverb Depth ─┐
└ U.Organ : 8 ─┘
    
```

Part **Accomp (Automatic Accompaniment except Bass), Rhythm, M.Drums, M.Perc, A.Bass (Bass part of Automatic Accompaniment), P.Organ, P.Orch, L.Organ, L.Symph, L.Orch, U.Organ, U.Symph, U.Orch, Solo**

Settings **0 – 10**
AUTO (Accomp, Rhythm, A.Bass)

For the three Parts of the Accomp, Rhythm and Accompaniment Bass, you have the option of selecting the "AUTO" setting. Parts for which "AUTO" is selected will be set to the Reverb Depth that is most suitable for the Rhythm currently selected.

Changing the Sustain Length

The sustain length can be set independently (SHORT, MIDDLE (Medium) or LONG) for the Upper and Lower keyboards and Bass Pedalboard. You can make a separate setting for each keyboard.

```

┌ Sustain Length ─┐
└ Upper : LONG ─┘
    
```

Keyboard **Upper, Lower, Pedal**
 Settings **SHORT, MIDDLE, LONG**

Rotary Speed

This setting allows you to finely adjust the speed of the Rotary effect. You can select from the three available speeds.

```

┌ Rotary Speed ─┐
└ NORMAL ─┘
    
```

Settings **SLOW, NORMAL, FAST**

* *This setting remains stored in memory even when power is turned off.*

Rotary Color

This setting allows you to choose the brightness of the Rotary sound obtained when using the Rotary effect.

```

┌ Rotary Color ─┐
└ MELLOW ─┘
    
```

Settings **BRIGHT, MELLOW**

* *This setting remains stored in memory even while power is turned off.*

Various Other Settings (Utility Button)

You can adjust the settings for the following items (menus).

Initial Touch

Initial Touch ON/OFF

Pedal Bass Mode

How the Bass Pedalboard can be played

Solo Mode

Changing how the Solo voice will sound

Registration Shift

Using the right Foot Switch to switch Registrations

Left Foot Switch Assignment

Selecting function for left Foot Switch

Right Foot Switch Assignment

Selecting function for right Foot Switch

Damper (Sustain) Pedal Assignment

Specifying which keyboard will be affected when you press the Damper (Sustain) pedal

Bender/Vibrato Destination

Setting determines which keyboard will be controlled by the Pitch Bend/Vibrato lever

Pitch Bend Range

The maximum amount of Pitch range permissible

Harmony Intelligence Type

Selecting the Harmony Intelligence type.

Manual Drums Set

Selecting the Manual Drums type

Manual Percussion Set

Selecting the Manual Percussion type

Solo to Lower Mode

Changing the range in which the Solo voice will sound

Solo Split Point

The playable range of the Solo Voice

Bass Split Point

The playable range of the Pedal Bass Voice

Chord Hold

Chord Hold ON/OFF

Registration Arranger Update

Arranger settings recall timing

Registration Transpose Update

Transpose setting recall timing

Expression Curve

The depth of the Expression Pedal effect

Tx MIDI Channel

MIDI output channel

MIDI-IN Mode

Send PC Switch

Specifying Transmission of PC Numbers

PC Number

Specifying PC Numbers

Master Tune

Adjusting the basic pitch

LCD Contrast

Adjusting the contrast of the display

1. Press the [Utility] button.
2. Press the [◀] and [▶] Menu buttons to select the desired menu.
3. For "Initial Touch" or "Tx MIDI Channel," use the [◀] and [▶] Part buttons to select the keyboard or part.
For "PC Number," use the [◀] and [▶] Part buttons to select the settings.
4. Use the [-] and [+] Value buttons to set the desired value.

To return to the basic screen, press the [Utility] button or the [Display/Exit] button

Initial Touch (Initial Touch ON/OFF)

Initial Touch is a function that translates the force used in playing the keys into a directly proportional amount of volume. It can be switched ON/OFF independently for the Upper and Lower keyboards.

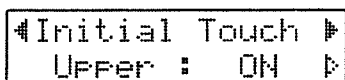

- Part Upper, Lower
- ON The harder you play the key, the higher the volume.
- OFF Volume remains constant regardless of how hard you play.

Pedal Bass Mode (How the Bass Pedalboard Can Be Played)

You can set the Bass Pedalboard to play simultaneous multiple notes or single notes only.



- MONOPHONIC Only single notes can be played.
- POLYPHONIC Multiple notes can be played.

Solo Mode (Changing How the Solo Voice Will Sound)

When the Solo voice is assigned to the Upper keyboard or the Lower keyboard, you can specify how the Solo voice will sound when more than one key is pressed.

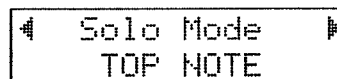

- TOP NOTE The Solo voice will sound the highest note that is played for the Solo part.
- LAST NOTE The Solo voice will sound the note that was most recently played for the Solo part.
- POLYPHONIC The Solo voice will sound all notes that are played for the Solo part.

Regist Shift (Use the Right Foot Switch to Switch Through Registrations)

You can use the right Foot Switch as a dedicated switch for selecting Registrations in order.

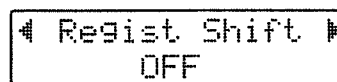

- ON Dedicated switch for selecting Registrations
- OFF Functions other than selecting Registrations can also be used

If Regist Shift is turned ON, each time you press the right Foot Switch, the Registrations will be selected in the following order: 1 → 2 → 3 → ... → 8 → 1 → .. etc.

→ This setting remains stored in memory even while the power is turned off.

Left/Right Foot Switch Assignment

You can select any of the following functions and assign them to either Foot Switch on the right or left side of the Expression Pedal.

- Left Foot Switch

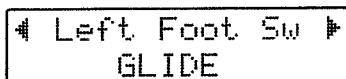

Left Foot Sw
GLIDE

- Right Foot Switch

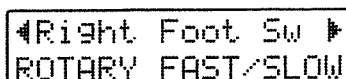

Right Foot Sw
ROTARY FAST/SLOW

Function

Description

ROTARY FAST/SLOW

Switch the Rotary speed between "FAST" and "SLOW."

GLIDE

While the Foot Switch is pressed, the pitch will temporarily be lowered, and will gradually return to normal when you release the Foot Switch.

LEADING BASS

The Leading Bass function (p. 43) will operate only while you continue pressing the Foot Switch.

RHYTHM START/STOP

Start/Stop the Rhythm.

COMPOSER PLAY/STOP

The same function as the Composer [Play] button and [Stop] button. Each time you press the Foot Switch, the performance data will play back or stop.

INTRO/ENDING

Play an Intro or Ending.

FILL IN TO VARIATION

After inserting a Fill-In, playback will switch to the variation pattern.

FILL IN TO ORIGINAL

After inserting a Fill-In, playback will switch to the original pattern.

ADVANCED/BASIC

Switch the pattern between the basic arrangement (BASIC) and a more complex arrangement (ADVANCED).

BREAK

The same function as the [Break] button (p. 40).

DAMPER OF UPPER

Notes played on the Upper keyboard will be sustained only while you continue pressing the Foot Switch.

* If the Utility menu "Registration Shift" setting is "ON", the right Foot Switch will be dedicated to switching through the Registrations, and the "Right Foot Switch Assignment" setting will be ignored.

Damper Pedal Assignment

You can specify which keyboard will be affected when you press the Damper (Sustain) pedal.

◀ Damper Pedal ▶
to LOWER

UPPER The effect is applied to the voices played on the Upper keyboard.

LOWER The effect is applied to the voices played on the Lower keyboard.

If the voice is a percussive voice (such as a Piano voice), the tone will be sustained, but fade away just like an acoustic piano. If the voice is a non-percussive instrument (such as a String voice), the tone will be sustained as long as the pedal is depressed.

Bender/Vibrato Destination

This setting determines which keyboard will be controlled by the Pitch Bend/Vibrato lever.

◀ Bender/Vibrato ▶
to UPPER

UPPER The effect is applied to the voices played on the Upper keyboard.

LOWER The effect is applied to the voices played on the Lower keyboard.

PEDAL The effect is applied to the voices played on the Pedalboard.

Pitch Bend Range

This setting allows you to choose the maximum amount of Pitch change (range) permissible when using Pitch Bend. The range can be set anywhere between 1–12 (in semitone units; but with a maximum of one octave).

◀ PitchBendRange ▶
2

* *Manual Drums is fixed at one octave range, regardless of this setting.*

Harmony Intelligence Type (Selecting the Type of the Harmony Intelligence)

This setting allows you to select the type of the Harmony Intelligence.

◀ Harmony Type ▶
TRADITIONAL

Settings **TRADITIONAL, ORGAN, COMBO, STRINGS, HYMN, BLOCK, HARP, JAZZ SCAT, BIG BAND, BROADWAY, OCTAVE1, OCTAVE2**

Manual Drums Set

This setting allows you to choose one of the following 12 Drum Sets or one Sound Effects Set.

◀ ManualDrumsSet ▶
STANDARD

Settings **STANDARD, STANDARD2, ROOM, ROOM2, POWER, ELECTRONIC, TR-808, DANCE, JAZZ, BRUSH, BRUSH2, ORCHESTRA, SOUND EFFECTS**

→ *The combination of sounds that are assigned to each key will differ depending on which Manual Drum Set is selected. For details refer to "Drum Set List" (p. 123).*

→ *You can select Manual Drum Set using the [Manual Drums] button and the [-]/[+] Value buttons (p. 34).*

Various Other Settings (Utility Button)

Manual Percussion Set

This setting allows you to choose one of the following 3 Percussion Sets.

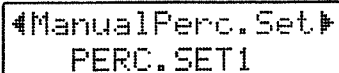

Manual Perc. Set
PERC.SET1

Settings PERC.SET1, PERC.SET2, VOICEPHRASE

→ The combination of sounds that are assigned to each key will differ depending on which manual percussion set is selected. For details refer to "Manual Percussion Set" (p. 126).

Solo to Lower Mode (Layering the Solo Voice and Lower Voice)

When the Solo voice is being played by the Lower keyboard (i.e., when the Solo [To Lower] button is ON), you can specify whether the Lower voice and the Solo voice will sound together (layered), or will sound separately (split).

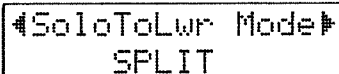

Solo To Lwr Mode
SPLIT

SPLIT The parts will sound separately.

LAYER The Lower voice and Solo voice will sound together.

Solo Split Point

This setting is used to determine the Solo Split Point (lower limit of the playable range of the Solo voice) on the Lower keyboard to any desired position.

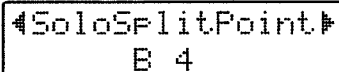

Solo Split Point
B 4

Settings C2 to C7

→ By simultaneously pressing the [+] and [-] Value buttons, you can restore the default setting (B4).

Bass Split Point

You can assign the Bass Split Point (the highest key, up to which the Pedal Bass voice will sound), to any key of the Lower keyboard.

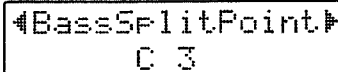

Bass Split Point
C 3

Settings C2 to C7

→ If you simultaneously press the [+] and [-] Value buttons, this will be reset to the initial (default) value (C3).

Chord Hold (Chord Hold ON/OFF)

The Chord Hold function can be switched ON/OFF. When Chord Hold is ON, the Automatic Accompaniment will continue playing even when you lift your hand from the keyboard to play a new chord.

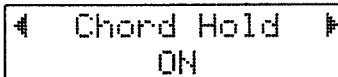

Chord Hold
ON

ON The Automatic Accompaniment determined by the chord played on the Lower keyboard is held (even if you release the keys).

OFF When you release the keys that you played in the Lower keyboard, the Automatic Accompaniment will stop (be muted). Only the Rhythm (drum) performance will continue.

Registration Arranger Update (Arranger Settings Recall Timing)

You can specify how the settings related to Rhythm performances and Automatic Accompaniment will be recalled when you press a Registration button [1] – [8].

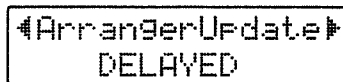

DELAYED Settings related to Rhythm performances and Automatic Accompaniment will be recalled when you hold a Registration button [1] – [8] for several seconds. If you quickly press the Registration button, only the panel settings (voice, etc.) that are not related to Rhythm and Automatic Accompaniment will be updated.

INSTANT Settings related to Rhythm performances and Automatic Accompaniment will be recalled the instant you press a button [1] – [8] along with all other panel settings.

→ This setting remains stored in memory even while power is turned off.

Registration Transpose Update (Transpose Setting Recall Timing)

You can specify how the transpose setting will be recalled when you press a Registration button [1] – [8].

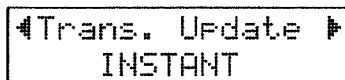

DELAYED Transpose settings will be recalled when you hold a Registration button [1] – [8] for several seconds.

INSTANT Transpose setting will be recalled the instant you press a button [1] – [8] along with all other panel settings.

→ This setting remains stored in memory even while power is turned off.

Expression Curve (Depth of the Expression Pedal Effect)

This feature specifies how the Expression pedal will affect the sound when it is pressed.

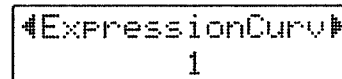

- 1 The Expression pedal will change the volume of the Rhythm and Automatic Accompaniment playback to a lesser degree than the volume of the keyboard voices.
- 2, 3 The Expression pedal will change the volume of the Rhythm and Automatic Accompaniment playback and the keyboard voices to the same degree.

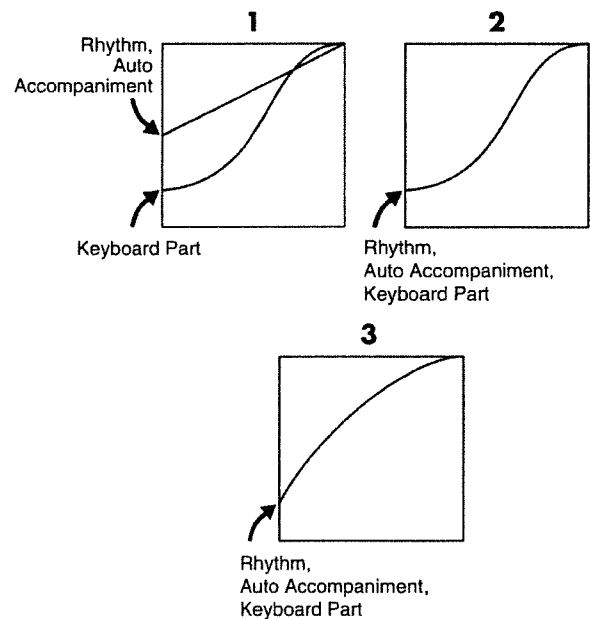

→ This setting remains stored in memory even while power is turned off.

Various Other Settings (Utility Button)

Tx MIDI Channel (MIDI Output Channel)

When you use the MIDI connectors or the computer connector of the AT-60R to transmit musical data to external devices, for each keyboard (Upper, Lower, and Pedal) you can specify the channel on which your playing will be transmitted as MIDI messages. (Value: 1–16)

You can modify these Tx (Transmit) MIDI settings as needed. (For details refer to p. 116)

```

┌ TxMIDI Channel ─┐
│ Upper : 13 ─┐
└────────────────┘
    
```

Part **Upper, Lower, Pedal, Solo, Control**
 Channel **1-16**

- * The Control part transmits Expression pedal data and PC numbers.
 - * It is not possible to set more than one part (Upper, Lower and Pedal) to the same channel.
 - * MIDI messages for the Solo part will be transmitted only when the Solo [To Lower] button is ON.
- The Tx (Transmit) MIDI setting of the Control track remains stored in memory even while power is turned off.

MIDI IN Mode

This instrument contains two sound generators: one for SMF data playback and one for keyboard performance.

Normally, data received at the MIDI In connector will control only the sound generator for SMF data playback. However by changing the MIDI IN Mode setting, you can also control the keyboard sound generator from MIDI In.

```

┌ MIDI IN Mode ─┐
│ MODE 1 ─┐
└──────────┘
    
```

- MODE 1** Control the instrument as a GS sound generator
- MODE 2** Channels 1–8 and channel 10 will be sent to the GS sound generator, and channel 9 and channels 11–16 will be sent to the keyboard sound generator.

Channel	MODE 1	MODE 2
1–8	GS	GS
9	GS	Manual Drums
10	GS	GS
11	GS	Manual Percussion
12	GS	Lower
13	GS	Upper
14	GS	Pedal Bass
15	GS	Nothing
16	GS	Solo, Control

- * There are limitations on the types of MIDI messages that can be received by the keyboard sound source. For details refer to the "MIDI IMPLEMENTATION" (p. 135).
- This setting remains stored in memory even while power is turned off.

Send PC Switch (Specifying Transmission of PC Numbers)

Transmission of PC (Program Change) numbers can be switched ON/OFF when a Registration is selected.

Send PC Switch
OFF

ON PC numbers are transmitted
OFF PC numbers are not transmitted

→ This setting remains stored in memory even while power is turned off.

PC Number (Specifying PC Numbers)

You can specify the Program Change number that will be transmitted from MIDI Out when a Registration is selected.

PC Number
PC Num: 1

Setting	Bank MSB (Bank Select MSB)	0-127
	Bank LSB (Bank Select LSB)	0-127
	PC Num (PC Number)	1-128

Use the [◀] and [▶] Part buttons to select the settings.

Master Tune

The basic pitch of an instrument is generally considered as the pitch of the middle A note. The “Master Tune” parameter lets you adjust this basic pitch to match the pitch of any other instruments that are playing together with the AT-60R.

Master Tune
440.0 Hz

Settings 415.3Hz – 466.2Hz (0.1 Hz units)

→ By pressing the [+] and [-] Value buttons simultaneously, you can restore the default setting (440.0 Hz).

→ This setting remains stored in memory even while power is turned off.

LCD Contrast

This setting allows you to adjust the contrast of the display.

LCD Contrast
5

Available settings 1-10 (higher values will darken the display)

→ By pressing the [+] and [-] Value buttons simultaneously, you can restore the default setting (5).

→ This setting remains stored in memory even while power is turned off.

Connecting External Devices

If you want to hook up an external instrument to the AT-60R, then this chapter is for you.

Names and Functions of Jacks and Connectors

1 MIDI Out/In Connectors

You can connect external MIDI instruments to these connectors to exchange performance information.

2 Input L (mono)/R Jacks

You can play output from other sound generators by connecting these sources to the AT-60R's input terminals.

3 Output L (mono)/R Jacks

You can some sounds if you connect speakers or other audio equipment to these jacks. You can also hook up a portable stereo to record your performances on cassette tape.

4 Computer Connector

You can connect a computer to this connector to exchange performance information.

5 Computer Switch

Set this switch to Mac, PC-1, or PC-2 according to the type computer that's connected.

You can also switch between connections to the MIDI Out/In connectors and the Computer connector.

6 Phones Jack (p. 17)

7 Mic In Jack (p. 17)

8 Mic Echo Knob (p. 17)

9 Mic Volume Knob (p. 17)

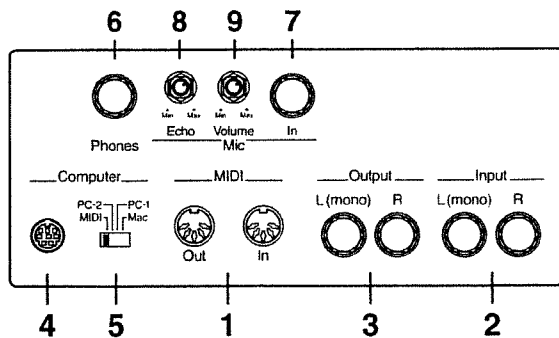

Making the Connections

If you're planning on connecting the AT-60R to other equipment with cables, be sure to follow the steps shown below to make the connections. By turning on or off devices in the wrong order, you risk causing malfunction and/or damage to speakers and other devices.

1. Turn down the volume all the way on all equipment.
2. Turn off the power to the AT-60R and other connected equipment.
3. Connect the AT-60R and other equipment with the cables.
4. Turn on the connected equipment.
5. Turn on the AT-60R.
6. Adjust the volume.

● After use, follow the steps below to switch off the power.

1. Turn down the volume all the way on all equipment.
2. Turn off the AT-60R.
3. Turn off the connected equipment.

■ Connecting Audio Equipment

You can hook up a tape recorder or other audio device and record your performances on the AT-60R. Use an audio cable to connect the input jack on the audio set or amp mixer to one of the output jacks on the AT-60R. Use an audio cable with a standard plug. When purchasing an audio cable, please consult the vendor where you bought the AT-60R.

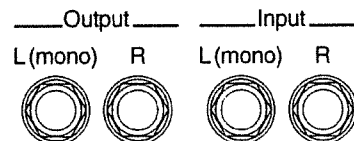

■ Connecting a Computer

The AT-60R provides a Computer connector. By connecting this to the serial port of your computer, you can transmit and receive musical data. Since the AT-60R is able to save musical data in SMF format, you can use your computer to edit the musical data.

1. Turn off the AT-60R and the computer.
2. Use a computer cable (sold separately) to connect the Computer connector on the AT-60R to a serial port on the computer.
3. Set the Computer switch on the bottom of the unit to match the type of connected computer.

→ Take a look at the Connection Examples.

4. Turn on the computer.
 5. Turn on the AT-60R.
 6. Make the settings for baud rate (transmission speed) for the computer and the software.
- For more information, refer to the documentation for the computer you are using.
7. You should also make the settings for the MIDI send channel (p. 112).

Connection Examples:

○ Connection with an Apple Macintosh computer

Use a computer cable (sold separately) to connect the Computer connector on the AT-60R to the modem port (or printer port) on the Apple Macintosh. Set the Computer switch to "Mac."

Use "PatchBay" on the Apple Macintosh to set the interface type (the clock speed for the MIDI interface) to "1 MHz."

○ Connection with an IBM PC

Use a computer cable (sold separately) to connect the Computer connector on the AT-60R to the COM1 or COM2 serial port on the IBM PC. Set the Computer switch to "PC-2."

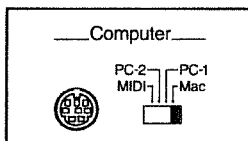
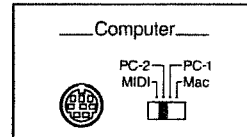

If You're Using MIDI

● About MIDI

MIDI stands for "Musical Instrument Digital Interface," and is a unified standard for the exchange of performance data and other information between electronic instruments and computers.

The AT-60R is equipped with MIDI connectors and a Computer connector to let it exchange performance information with external devices. These connectors can be used to connect the AT-60R to an external device for even greater versatility.

● About MIDI Connectors

The AT-60R has two kinds of MIDI connectors. Connecting these to the MIDI connectors on a MIDI instrument makes it possible for the two instruments to control each other.

For instance, you can output sound from the other instrument or switch tones on the other instrument. You should also set the MIDI send channel as needed.

○ MIDI Out Connector

Only the notes played on the keyboard, movements of the Damper pedal, Expression data, and data indicating that a Registration button [1]–[8] was pressed will be transmitted to the external MIDI connector. The Solo voice will be transmitted only if the Solo [To Lower] button is ON.

○ MIDI In Connector

Performance messages from an external MIDI device are received here.

These incoming messages may instruct the receiving MIDI instrument to play sounds or switch tones.

The AT-60R contains two sound generators: one sound generator for its own keyboards and one GS sound generator (p. 134). Normally, musical data transmitted from an external device to the MIDI In connector is sent to the GS sound generator, but you can also set the "MIDI IN Mode" parameter (p. 112) so that the keyboard sound generator is controlled.

■ Connecting the AT-60R to a MIDI Instrument

1. Turn off the AT-60R.
2. Set the Computer switch on the bottom of the AT-60R to "MIDI."

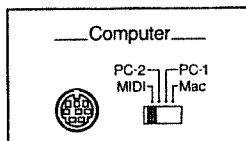

* When the AT-60R is powered up, the setting doesn't change until the power is reset, even if the computer switch is operated.

3. Use a MIDI cable (sold separately) to connect the MIDI connector on the external instrument to the MIDI connector on the AT-60R.
4. Turn on the external MIDI device and AT-60R.
5. You should also set the MIDI send channel and switch Local Control on or off as needed.

Connection Example:

- Connecting the MIDI Device

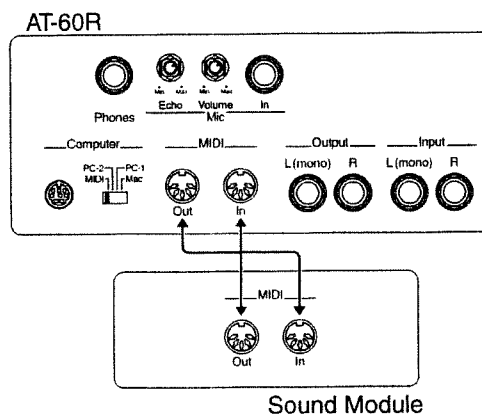

Troubleshooting

When you press the [Power] switch, the power doesn't come on.

- Power cord is not connected correctly (p. 15).

No sound is heard.

- The [Master Volume] slider is set too low (p. 16).
- Headphones are connected (p. 17).
When you connect the headphones, the sound is heard only through the headphones.
- The volume is set too low on the [Part Balance] buttons (p. 30).
- The volume is set too low on the Expression Pedal (p. 60).
- You do not have a Voice selected (p. 22).
Voices that have their button indicator lit can be played.
- You have selected Manual Drums for the Lower keyboard, and are playing a key to which no drum sound or Sound Effect has been assigned (p. 33, p. 123).
- "Percussion Set 3" has been selected for the Upper keyboard.
When "Percussion Set 3" is selected, some keys may have no sound assigned to them (p. 126).

No sound is heard (when a MIDI instrument is connected).

- The power of the connected external devices is not turned on (p. 114).
- The Computer switch on the bottom of the unit is not set to "MIDI" (p. 116).

Damper Pedal does not operate

- The damper pedal affects only the Lower keyboard and Upper keyboard. The damper pedal does not affect the Bass pedalboard.
You can change the settings so that the damper pedal affects the Upper keyboard (p. 109).
- The damper pedal does not affect the Solo voice.

Expression Pedal does not operate

- The Expression Pedal will not function while playing back performance data (SMF music data) from a device other than the Atelier series.
- The function of the Expression Pedal during recording (p. 96) or the function during playback (p. 97) has been set to "COMPOSER."

Can't use the function assigned to the right foot switch

- If the Utility menu item "Regist Shift" (change Registrations) is ON (p. 107), the right foot switch will be dedicated to switching the Registration.

When the human voice "Jazz Scat" is selected, playing dynamics do not change the sound

- The Utility menu item "Initial Touch" is turned OFF (p. 107).

Rotary effect is not be applied.

- Some sounds do not allow the rotary effect to be applied (p. 121).

Chorus effect does not apply

- Some sounds do not allow the chorus effect to be applied (p. 121).

When you release your fingers from keys in the Lower keyboard while Automatic Accompaniment and Rhythm are playing, the Rhythm performance only remains playing.

- Chord Hold is at OFF (p. 110).
The Automatic Accompaniment will play while you press a chord. If Chord Hold is turned ON, the Automatic Accompaniment will continue playing with the Rhythm even when you take your hand off of the Lower keyboard.

When you release your fingers from keys in the Lower keyboard, the notes continue sounding.

- The Lower Voice [Hold] button is at ON (p. 43).

Even though you press only one key, a multiple number of notes sound.

- Harmony Intelligence is at ON (p. 49).
- Chord Intelligence is turned ON (p. 42).

Automatic Accompaniment sounds odd

- The keys for a chord were not pressed simultaneously.
- When Chord Intelligence is OFF (p. 42), the chord is not being pressed correctly.
- When performance data from a device other than the AT-60R is being played together with the Automatic Accompaniment, the Automatic Accompaniment may not be sounded correctly.

Rhythm sounds odd

- When performance data from a device other than the AT-60R is being played together with the Automatic Accompaniment, the Rhythm performance may not be sounded correctly.

Pitch is off.

- Transpose is in effect (p. 59).
- The tuning is incorrect (p. 113).
- While set for an octave shift (p. 31), you are playing keys beyond the recommended range. This does not indicate a malfunction.

Performance data cannot be played back

- While the Function menu appears in the display (with the exception of Channel Mute), playback is not allowed. If you wish to playback performance data, press the [Function] button once again to exit the Function menu (p. 95).

Troubleshooting

Recording is not possible

- Punch-in recording has been selected (p. 91).
- If you wish to erase a previously-recorded track and then re-record, press the track button for the desired track to make that button indicator blink before you begin recording (p. 79).
- While the Function menu appears in the display (with the exception of Channel Mute), recording is not allowed. If you wish to record performance data, press the [Function] button once again to exit the Function menu.

Lyrics are not indicated properly in the display

- With some music files, the lyrics cannot be displayed correctly.
- If you press a button while the lyrics are being shown in the display, the lyrics will disappear. To recall them, press the [Play] button.

The recorded performance has disappeared

- Any performance that has been recorded is deleted when the power to the unit is turned off. A performance cannot be restored once it's been deleted, so be sure to save it on a floppy disk before you turn off the power (p. 84).

The voice you assigned to the [Others] button has changed

- When you press the [Others Preset] button, sounds appropriate to the footage voice will automatically be assigned to the Upper/Lower [Others] buttons.

The bass note of the Automatic Accompaniment does not sound

- When a voice is selected for the Pedal Bass part, the bass of the Automatic Accompaniment will not sound.

When you started a Rhythm with an Intro, the Rhythm did not sound

- Some Rhythms do not have rhythm sounds in the intro.

MIDI messages received at MIDI In are not sounded

- The Computer switch is not set to "MIDI" position (p. 116).
- The Computer switch was set to "MIDI" after the power was turned on.
Turn off the power, and then turn the power on once again.

Sound is distorted / cracked

- The Part Balance volume of each part is too high (p. 30).
- The Reverb volume has been raised when the volume of each Part Balance button is already raised.
Either lower the Reverb volume, or adjust the Part Balance of each part (p. 30).
- The [Master Volume] slider has been used to raise the overall volume excessively (p. 16).

Some keys (of certain keyboard parts) sound strange

- You've assigned the same voice, using the same range, to multiple parts.

The Rhythm does not change when you press the Registration [1]-[8] buttons

- The settings at which Registrations are recalled (Registration Arranger Update) has been set to "DELAYED" (p. 111).

The volume changes during playback of performance data

- When recording is performed repeatedly while changing the Part Balance volume, the previously-recorded Part Balance data remains in the Control track. If you wish to get rid of the volume changes, use the Erase function (p. 101) to delete the Part Balance data.

Bass is heard even though you are not playing the Bass Pedalboard

- The Pedal Bass [To Lower] button (p. 58) or the [Bass Split] button (p. 57) is ON.
When the Pedal Bass [To Lower] button is ON, the Bass will be sounded by the Lower keyboard.

When playing the same sound in the Upper keyboard and Lower keyboard, the volume is different

- On one of the keyboards, "Initial Touch" is turned ON (p. 107).

Lower keyboard cannot be heard

- The Lower keyboard will not produce sound while an Intro or Ending is being played.

The sound is not played correctly

- If you layer the same type of sound (for example, Strings 1 and Strings 5), or play an octave-shifted organ sound, the timing at which you play a note or the phase relationship between the two sounds may affect the way in which the sounds are heard, but this is not a malfunction.

Can't play the demo songs

- A floppy disk is inserted in the disk drive.
In order to play the demo song, you must remove the floppy disk from the disk drive (p. 46).

Can't select Rhythms from a Music Style disk

- The Rhythm [Disk] button has not been selected (p. 46).

Display Messages

■ E.00

Copy Protected.
Can't Save

Meanings:

- To protect the copyright, this music file cannot be saved as SMF format.
- When you want to save as Atelier format, you can save only original disk.

■ E.01

Can't Save
This Song.

Meanings:

- You can only play the music data. It cannot be saved on a floppy disk or internal memory.

■ E.02

Write Protected
Disk

Meanings:

- The protect tab on the floppy disk is set to the Protect position.
Change it to the Write position and repeat the procedure.

■ E.03

Master Disk

Meanings:

- This floppy disk cannot store the format or save any data. Insert a different disk and repeat the procedure.

■ E.05

Read Only Song.
Can't Save

Meanings:

- A new song cannot be saved onto this floppy disk.

■ E.10

No Disk

Meanings:

- No floppy disk is connected to the disk drive. Insert the disk correctly, and repeat the procedure.

■ E.11

Disk Full

Meanings:

- There is not sufficient space left on the floppy disk for the data to be saved. Save the data onto a different floppy disk or delete music data on the disk.

■ E.12

Unknown Disk

Meanings:

- The floppy disk inserted into the disk drive cannot be read. Please format the floppy disk.

■ E.13

Disk Ejected

Meanings:

- The floppy disk was removed from the disk drive while loading or writing was in progress. Insert the floppy disk and repeat the procedure.

■ E.14

Damaged Disk

Meanings:

- This floppy disk is damaged and cannot be used. Insert a different disk and repeat the procedure.

■ E.15

Can't Read

Meanings:

- This song cannot be read.

■ E.16

Can't Play

Meanings:

- It cannot be read the floppy disk quickly enough. Press the [Reset] button, then press the [Play] button to play the song.

Display Messages

■ E.30

Memory Full

Meanings:

- The Rhythm data is excessively large, and cannot be loaded.
- The performance data is excessively large, and cannot be loaded.
- Since the internal memory is full, recording or editing is not possible.

■ E.40

MIDI Buffer Full

Meanings:

- The AT-60R cannot deal with the excessive MIDI data sent from the external MIDI device. Reduce the amount of MIDI data sent to the AT-60R.

■ E.41

Communication
Error

Meanings:

- A MIDI cable or computer cable has been disconnected. Connect it properly and securely.

■ E.43

Computer I/F
Error

Meanings:

- The Computer Switch is set to a wrong position or the computer is set wrongly. Switch off the AT-60R then set the Computer Switch to the correct position and set the computer correctly. After that, switch on the AT-60R again.

■ E.51

Memory Error

Meanings:

- There is something wrong with the system. Repeat the procedure from the beginning.

■ Others

Factory Preset
is Loaded.

Meanings:

- The internal settings (Registrations, etc.) were lost, because the instrument was not turned on for about two weeks. The basic screen will appear after the instrument has been returned automatically to all the factory default settings.

Internal Memory
Near Limit

Meanings:

- The AT-60R is warning you that its memory will soon become full to capacity, so not much more recording can be done.

Clear Song Sure?
Yes:REC No:RST

Meanings:

- To carry out the procedure, you first need to erase performance data in the AT-60R. This message asks you to confirm that you don't mind doing this. To erase the data, press the [Rec] button.
When you do not want to erase it, press the [Reset] button then save the data on disk.

Overwrite Regist?
Yes:REC No:RST

Meanings:

- This Registration is already being used. To overwrite the previous Registration data in this memory, press the [Rec] button. If you decide to keep the previous Registration data in this memory and save your settings in an unused memory, press the [Reset] button, press the [Select] button to select a number for which "---" is displayed, and then save the data.

Overwrite Song ?
Yes:REC No:RST

Meanings:

- There already is performance data having the same name on the disk.
To replace the existing data with the new version, press the [Rec] button. To save it as a separate new file, press the [Reset] button first. Then, after changing the name, save it on disk.

Voice List

A11	Full Organ1	*1	D38	Eng.Horn 8'		J22	Gregorian	
A12	Full Organ2	*1	E11	Theater Or.1	*2	J23	Classical	
A13	Full Organ3	*1	E12	Theater Or.2	*2	J24	Boys Choir	
A14	Full Organ4	*1	E13	Theater Or.3	*2	J31	Synth. Choir	
A15	Full Organ5	*1	E14	Theater Or.4	*2	J32	Synth. Voice	*2
A16	Full Organ6	*1	E15	Theater Or.5	*2	J33	Space Voice	
A17	Full Organ7	*1	E16	Theater Or.6	*2	J41	Vocal Menu	
B11	Jazz Organ1	*1	E17	Theater Or.7	*2	K11	Grand Piano	
B12	Jazz Organ2	*1	F11	Synth. Org.1	*2	K12	Piano1	
B13	Jazz Organ3	*1	F12	Synth. Org.2		K13	Piano2	
B14	Jazz Organ4	*1	F13	Synth. Org.3	*2	K14	Piano3	
B15	Jazz Organ5	*1	F14	Synth. Org.4	*2	K21	Honky-tonk	
B16	Jazz Organ6	*1	F21	Pop. Organ1	*1	K22	Honky-tonk2	
B21	Rock Organ1		F22	Pop. Organ2	*1	K31	E.Piano1	
B22	Rock Organ2		F23	Pop. Organ3	*1	K32	E.Piano2	
C11	Lower Organ1	*1	G11	Strings1		K33	E.Piano3	
C12	Lower Organ2	*1	G12	Strings2		K34	E.Piano4	*2
C13	Lower Organ3	*1	G13	Strings3	*2	K41	Harpsichord	
C14	Lower Organ4	*1	G14	Strings4	*2	K42	Clavi.	
C15	Lower Organ5	*1	G15	Strings5		L11	Accordion	
C16	Lower Organ6	*1	G16	Strings6		L12	Bandoneon	*2
D11	Pipe Organ1		G17	Strings7	*2	L21	Harmonica	*2
D12	Pipe Organ2		G18	Strings8	*2	M11	Nylon-str.Gt	*2
D13	Pipe Organ3		H11	Slow Str.1		M12	Nylon Gt. 2	*2
D14	Pipe Organ4		H12	Slow Str.2		M21	Steel-str.Gt	*2
D15	Pipe Organ5		H13	Slow Str.3	*2	M31	Jazz Guitar	*2
D16	Pipe Organ6		H21	Synth. Str.1		M32	Clean Guitar	*2
D17	Pipe Organ7		H22	Synth. Str.2		M33	JC E.Guitar	*2
D21	Diapason 8'		H23	Synth. Str.3		M41	Overdrive Gt	*2
D22	FluteCeleste		H31	Synth. Pad1		N11	Hawaiian Gt.	*2
D23	Gemshorn 8'		H32	Synth. Pad2		N12	Banjo	*2
D24	Trompet 8'		I11	Violin	*2	N13	Mandolin	
D25	Hautbois 8'		I12	Viola	*2	N14	Koto	*2
D26	Viola 8'		I13	Cello	*2	N15	Taisho Koto	*2
D27	ViolaCeleste		I14	Pizzicato	*2	N16	Shamisen	*2
D28	Bombarde16'		J11	Jazz Scat	*2	N21	Harp	*2
D31	T.String 8'	*2	J12	Pop Voice	*2	N31	Sitar	*2
D32	VoxHumana 8'	*2	J13	Jazz Doo	*2	N41	Organ Harp	*2
D33	T.Tuba 8'	*2	J14	Jazz Doot	*2	O11	Vibraphone	*2
D34	T.Trumpet 8'	*2	J15	Jazz Dat	*2	O12	Glockenspiel	
D35	T.Sax 8'	*2	J16	Jazz Bap	*2	O13	Celesta	
D36	T.Oboe 8'	*2	J17	JazzDowfall	*2	O21	Marimba	
D37	T.Krumet 8'		J21	Choir		O22	Xylophone	

*1: Rotary: effective, Chorus: ineffective

*2: Vibrato: effective, Aftertouch: effective

Voice List

O31	Tubular-bell		S15	Synth. Lead5	*2
O41	Steel Drums		T11	Organ Bass1	
O42	Kalimba	*2	T12	Organ Bass2	
O51	Organ Bell		T21	Pipe Org. Bs	
O52	Vibra Bells	*2	T22	Theater Bass	
P11	Tp. Section	*2	T23	Bombarde	
P21	Fr.Horn Sect		T31	String Bass	*2
P22	Fr.HornSect2		T32	Bass+Cymbal	*2
P31	Sax.Section	*2	T33	String Bass2	*2
P32	Sax.Section2	*2	T41	Contrabass1	*2
P41	Synth. Brass	*2	T42	Contrabass2	
Q11	Trumpet	*2	T51	E.Bass1	
Q12	Trumpet2	*2	T52	E.Bass2	*2
Q21	Mute Trumpet	*2	T53	E.Bass3	*2
Q22	MuteTrumpet2	*2	T54	E.Bass4	*2
Q31	Trombone	*2	T61	Tuba	
Q32	Trombone2	*2	T62	Tuba2	*2
Q41	Flugel Horn	*2	T71	Synth. Bass1	
Q42	F.Horn Solo1	*2	T72	Synth. Bass2	
Q51	Soprano Sax	*2	T81	Voice Thum	
Q52	Soprano Sax2	*2	U11	Org. Attack1	
Q61	Alto Sax	*2	U12	Org. Attack2	
Q62	Alto Sax2	*2	U13	Org. Attack3	
Q71	Tenor Sax	*2	U14	Org. Attack4	
Q72	Tenor Sax2	*2	U15	Org. Click	
R11	Flute	*2	V11	Timpani	
R12	Flute2	*2	V12	Timpani2	
R13	Flute3	*2	V21	Ride Cymbal	
R21	Synth. Flute		V22	Crash Cymbal	*2
R22	Pan Flute	*2	V23	Tambourine	
R31	Oboe	*2	V24	Woodblock	
R32	Bassoon	*2	V25	Jingle Bell	*2
R41	Clarinet	*2	V26	Snare Drum	
R42	Clarinet2	*2	V27	Bass Drum	
R43	Clarinet3	*2	V31	Perc. Set1	
R44	Clarinet4	*2	V32	Perc. Set2	
R45	Bs Clarinet	*2	V33	Perc. Set3	*2
R51	Shakuhachi	*2	V34	Orch.HitMenu	
R52	HumanWhistle	*2			
S11	Synth. Lead1	*2			
S12	Synth. Lead2	*2			
S13	Synth. Lead3	*2			
S14	Synth. Lead4	*2			

*1: Rotary: effective, Chorus: ineffective

*2: Vibrato: effective, Aftertouch: effective

Drum Set List

Manual Drum Set

	JAZZ STANDARD	STANDARD 2	ROOM	ROOM 2
C2	36 Std Kick 1	Kick 1	Std Kick 1	Room Kick
	37 Side Stick	Side Stick	Side Stick	Side Stick
	38 Snare Drum 1	Std Snr 1	Snare Drum 1	Room Snr 1
	39 Hand Clap	Hand Clap	Hand Clap	Hand Clap
	40 Snare Drum 2	Std Snr 2	Snare Drum 2	Std Snr 1
	41 Low Tom 2	Low Tom 2	Room Low Tom 2	Room Low Tom 2'
	42 Closed Hi-hat 1 [EXC1]	Closed Hi-hat 1' [EXC1]	Closed Hi-hat 1 [EXC1]	Closed Hi-hat 1' [EXC1]
	43 Low Tom 1	Low Tom 1	Room Low Tom 1	Room Low Tom 1'
	44 Pedal Hi-hat 1 [EXC1]	Pedal Hi-hat 1' [EXC1]	Pedal Hi-hat 1 [EXC1]	Pedal Hi-hat 1' [EXC1]
	45 Mid Tom 2	Mid Tom 2	Room Mid Tom 2	Room Mid Tom 2'
	46 Open Hi-hat 1 [EXC1]	Open Hi-hat 1' [EXC1]	Open Hi-hat 1 [EXC1]	Open Hi-hat 1' [EXC1]
	47 Mid Tom 1	Mid Tom 1	Room Mid Tom 1	Room Mid Tom 1'
C3	48 High Tom 2	High Tom 2	Room Hi Tom 2	Room Hi Tom 2'
	49 Crash Cymbal 1	Crash Cymbal 1	Crash Cymbal 1	Crash Cymbal 1
	50 High Tom 1	High Tom 1	Room Hi Tom 1	Room Hi Tom 1'
	51 Ride Cymbal 1	Ride Cymbal 1	Ride Cymbal 1	Ride Cymbal 1
	52 Chinese Cymbal	Chinese Cymbal	Chinese Cymbal	Chinese Cymbal
	53 Ride Bell	Ride Bell	Ride Bell	Ride Bell
	54 Tambourine	Tambourine	Tambourine	Tambourine
	55 Splash Cymbal	Splash Cymbal	Splash Cymbal	Splash Cymbal
	56 Cowbell	Cowbell	Cowbell	Cowbell
	57 Crash Cymbal 2	Crash Cymbal 2	Crash Cymbal 2	Crash Cymbal 2
	58 Vibra-slap	Vibra-slap	Vibra-slap	Vibra-slap
	59 Ride Cymbal 2	Ride Cymbal 2	Ride Cymbal 2	Ride Cymbal 2
C4	60 High Bongo	High Bongo	High Bongo	High Bongo
	61 Low Bongo	Low Bongo	Low Bongo	Low Bongo
	62 Mute High Conga	Mute High Conga	Mute High Conga	Mute High Conga
	63 Open High Conga	Open High Conga	Open High Conga	Open High Conga
	64 Low Conga	Low Conga	Low Conga	Low Conga
	65 High Timbale	High Timbale	High Timbale	High Timbale
	66 Low Timbale	Low Timbale	Low Timbale	Low Timbale
	67 High Agogo	High Agogo	High Agogo	High Agogo
	68 Low Agogo	Low Agogo	Low Agogo	Low Agogo
	69 Cabasa	Cabasa	Cabasa	Cabasa
	70 Maracas	Maracas	Maracas	Maracas
	Short Hi Whistle [EXC2]	Short Hi Whistle [EXC2]	Short Hi Whistle [EXC2]	Short Hi Whistle [EXC2]
C5	72 Long Low Whistle [EXC2]	Long Low Whistle [EXC2]	Long Low Whistle [EXC2]	Long Low Whistle [EXC2]
	73 Short Guiro [EXC3]	Short Guiro [EXC3]	Short Guiro [EXC3]	Short Guiro [EXC3]
	74 Long Guiro [EXC3]	Long Guiro [EXC3]	Long Guiro [EXC3]	Long Guiro [EXC3]
	75 Claves	Claves	Claves	Claves
	76 High Wood Block	High Wood Block	High Wood Block	High Wood Block
	77 Low Wood Block	Low Wood Block	Low Wood Block	Low Wood Block
	78 Mute Cuica [EXC4]	Mute Cuica [EXC4]	Mute Cuica [EXC4]	Mute Cuica [EXC4]
	79 Open Cuica [EXC4]	Open Cuica [EXC4]	Open Cuica [EXC4]	Open Cuica [EXC4]
	80 Mute Triangle [EXC5]	Mute Triangle [EXC5]	Mute Triangle [EXC5]	Mute Triangle [EXC5]
	81 Open Triangle [EXC5]	Open Triangle [EXC5]	Open Triangle [EXC5]	Open Triangle [EXC5]
	82 Shaker	Shaker	Shaker	Shaker
	83 Jingle Bell	Jingle Bell	Jingle Bell	Jingle Bell
C6	84 Bell Tree	Bell Tree	Bell Tree	Bell Tree
	85 Castanets	Castanets	Castanets	Castanets
	86 Mute Surdo [EXC6]	Mute Surdo [EXC6]	Mute Surdo [EXC6]	Mute Surdo [EXC6]
	87 Open Surdo [EXC6]	Open Surdo [EXC6]	Open Surdo [EXC6]	Open Surdo [EXC6]
	88 -----	-----	-----	-----

--- : no sound

[EXC] : will not sound simultaneously with other percussion instruments of the same number

Drum Set List

	POWER	ELECTRONIC	TR-808	DANCE
C2	36 MONDO Kick	Elec BD	808 Bass Drum 1	808 Bass Drum 2
	37 Side Stick	Side Stick	808 Rim Shot	808 Rim Shot
	38 Gated SD	Elec SD	808 Snare Drum	TR-909 Snr
	39 Hand Clap	Hand Clap	Hand Clap	Hand Clap
	40 Snare Drum 2	Gated SD	Snare Drum 2	Dance Snr 2
	41 Room Low Tom 2	Elec Low Tom 2	808 Low Tom 2	808 Low Tom 2
	42 Closed Hi-hat 1 [EXC1]	Closed Hi-hat 1 [EXC1]	808 CHH [EXC1]	808 CHH [EXC1]
	43 Room Low Tom 1	Elec Low Tom 1	808 Low Tom 1	808 Low Tom 1
	44 Pedal Hi-hat 1 [EXC1]	Pedal Hi-hat 1 [EXC1]	808 CHH [EXC1]	808 CHH [EXC1]
	45 Room Mid Tom 2	Elec Mid Tom 2	808 Mid Tom 2	808 Mid Tom 2
	46 Open Hi-hat 1 [EXC1]	Open Hi-hat 1 [EXC1]	808 OHH [EXC1]	808 OHH [EXC1]
	47 Room Mid Tom 1	Elec Mid Tom 1	808 Mid Tom 1	808 Mid Tom 1
C3	48 Room Hi Tom 2	Elec Hi Tom 2	808 Hi Tom 2	808 Hi Tom 2
	49 Crash Cymbal 1	Crash Cymbal 1	808 Cymbal	808 Cymbal
	50 Room Hi Tom 1	Elec Hi Tom 1	808 Hi Tom 1	808 Hi Tom 1
	51 Ride Cymbal 1	Ride Cymbal 1	Ride Cymbal 1	Ride Cymbal 1
	52 Chinese Cymbal	Reverse Cymbal	Chinese Cymbal	Chinese Cymbal
	Ride Bell	Ride Bell	Ride Bell	Ride Bell
	53 Tambourine	Tambourine	Tambourine	Tambourine
	54 Splash Cymbal	Splash Cymbal	Splash Cymbal	Splash Cymbal
	55 Cowbell	Cowbell	808 Cowbell	808 Cowbell
	56 Crash Cymbal 2	Crash Cymbal 2	Crash Cymbal 2	Crash Cymbal 2
	57 Vibra-slap	Vibra-slap	Vibra-slap	Vibra-slap
	58 Ride Cymbal 2	Ride Cymbal 2	Ride Cymbal 2	Ride Cymbal 2
C4	60 High Bongo	High Bongo	High Bongo	High Bongo
	61 Low Bongo	Low Bongo	Low Bongo	Low Bongo
	62 Mute High Conga	Mute High Conga	808 High Conga	808 High Conga
	63 Open High Conga	Open High Conga	808 Mid Conga	808 Mid Conga
	64 Low Conga	Low Conga	808 Low Conga	808 Low Conga
	65 High Timbale	High Timbale	High Timbale	High Timbale
	66 Low Timbale	Low Timbale	Low Timbale	Low Timbale
	67 High Agogo	High Agogo	High Agogo	High Agogo
	68 Low Agogo	Low Agogo	Low Agogo	Low Agogo
	69 Cabasa	Cabasa	Cabasa	Cabasa
	70 Maracas	Maracas	808 Maracas	808 Maracas
	71 Short Hi Whistle [EXC2]	Short Hi Whistle [EXC2]	Short Hi Whistle [EXC2]	Short Hi Whistle [EXC2]
C5	72 Long Low Whistle [EXC2]	Long Low Whistle [EXC2]	Long Low Whistle [EXC2]	Long Low Whistle [EXC2]
	73 Short Guiro [EXC3]	Short Guiro [EXC3]	Short Guiro [EXC3]	Short Guiro [EXC3]
	74 Long Guiro [EXC3]	Long Guiro [EXC3]	Long Guiro [EXC3]	Long Guiro [EXC3]
	75 Claves	Claves	808 Claves	808 Claves
	76 High Wood Block	High Wood Block	High Wood Block	High Wood Block
	Low Wood Block	Low Wood Block	Low Wood Block	Low Wood Block
	77 Mute Cuica [EXC4]	Mute Cuica [EXC4]	Mute Cuica [EXC4]	Mute Cuica [EXC4]
	78 Open Cuica [EXC4]	Open Cuica [EXC4]	Open Cuica [EXC4]	Open Cuica [EXC4]
	79 Mute Triangle [EXC5]	Mute Triangle [EXC5]	Mute Triangle [EXC5]	Mute Triangle [EXC5]
	80 Open Triangle [EXC5]	Open Triangle [EXC5]	Open Triangle [EXC5]	Open Triangle [EXC5]
	81 Shaker	Shaker	Shaker	Shaker
	82 Jingle Bell	Jingle Bell	Jingle Bell	Jingle Bell
C6	84 Bell Tree	Bell Tree	Bell Tree	Bell Tree
	85 Castanets	Castanets	Castanets	Castanets
	86 Mute Surdo [EXC6]	Mute Surdo [EXC6]	Mute Surdo [EXC6]	Mute Surdo [EXC6]
	87 Open Surdo [EXC6]	Open Surdo [EXC6]	Open Surdo [EXC6]	Open Surdo [EXC6]
	88 -----	-----	-----	-----

--- : no sound

[EXC] : will not sound simultaneously with other percussion instruments of the same number

Drum Set List

	BRUSH	BRUSH 2	ORCHESTRA	SOUND EFFECT	
C2	36	Std Kick 1	Kick 1	Concert BD 1	----
	37	Side Stick	Side Stick	Side Stick	----
	38	Brush Tap	Brush Tap	Concert SD	----
	39	Brush Slap	Brush Slap	Castanets	High Q
	40	Brush Swirl	Brush Swirl	Concert SD	Slap
	41	Low Tom 2	Brush Low Tom 2	Timpani F	Scratch Push [EXC7]
	42	Closed Hi-hat 1 [EXC1]	Closed Hi-hat 2 [EXC1]	Timpani F#	Scratch Pull [EXC7]
	43	Low Tom 1	Brush Low Tom 1	Timpani G	Sticks
	44	Pedal Hi-hat 1 [EXC1]	Pedal Hi-hat 2 [EXC1]	Timpani G#	Square Click
	45	Mid Tom 2	Brush Mid Tom 2	Timpani A	Metronome Click
46	Open Hi-hat 1 [EXC1]	Open Hi-hat 2 [EXC1]	Timpani A#	Metronome Bell	
47	Mid Tom 1	Brush Mid Tom 1	Timpani B	Guitar sliding Finger	
C3	48	High Tom 2	Brush Hi Tom 2	Timpani c	Guitar cutting noise (down)
	49	Crash Cymbal 1	Crash Cymbal 1	Timpani c#	Guitar cutting noise (up)
	50	High Tom 1	Brush Hi Tom 1	Timpani d	String slap of double bass
	51	Ride Cymbal 1	Ride Cymbal 1	Timpani d#	Fl.Key Click
	52	Chinese Cymbal	Chinese Cymbal	Timpani e	Laughing
	53	Ride Bell	Ride Bell	Timpani f	Screaming
	54	Tambourine	Tambourine	Tambourine	Punch
	55	Splash Cymbal	Splash Cymbal	Splash Cymbal	Heart Beat
	56	Cowbell	Cowbell	Cowbell	Footsteps1
	57	Crash Cymbal 2	Crash Cymbal 2	Concert Cymbal 2	Footsteps2
58	Vibra-slap	Vibra-slap	Vibra-slap	Applause	
59	Ride Cymbal 2	Ride Cymbal 2	Concert Cymbal 1	Door Creaking	
C4	60	High Bongo	High Bongo	High Bongo	Door
	61	Low Bongo	Low Bongo	Low Bongo	Scratch
	62	Mute High Conga	Mute High Conga	Mute High Conga	Wind Chimes
	63	Open High Conga	Open High Conga	Open High Conga	Car-Engine
	64	Low Conga	Low Conga	Low Conga	Car-Stop
	65	High Timbale	High Timbale	High Timbale	Car-Pass
	66	Low Timbale	Low Timbale	Low Timbale	Car-Crash
	67	High Agogo	High Agogo	High Agogo	Siren
	68	Low Agogo	Low Agogo	Low Agogo	Train
	69	Cabasa	Cabasa	Cabasa	Jetplane
70	Maracas	Maracas	Maracas	Helicopter	
71	Short Hi Whistle [EXC2]	Short Hi Whistle [EXC2]	Short Hi Whistle [EXC2]	Starship	
C5	72	Long Low Whistle [EXC2]	Long Low Whistle [EXC2]	Long Low Whistle [EXC2]	Gun Shot
	73	Short Guiro [EXC3]	Short Guiro [EXC3]	Short Guiro [EXC3]	Machine Gun
	74	Long Guiro [EXC3]	Long Guiro [EXC3]	Long Guiro [EXC3]	Lasergun
	75	Claves	Claves	Claves	Explosion
	76	High Wood Block	High Wood Block	High Wood Block	Dog
	77	Low Wood Block	Low Wood Block	Low Wood Block	Horse-Gallop
	78	Mute Cuica [EXC4]	Mute Cuica [EXC4]	Mute Cuica [EXC4]	Birds
	79	Open Cuica [EXC4]	Open Cuica [EXC4]	Open Cuica [EXC4]	Rain
	80	Mute Triangle [EXC5]	Mute Triangle [EXC5]	Mute Triangle [EXC5]	Thunder
	81	Open Triangle [EXC5]	Open Triangle [EXC5]	Open Triangle [EXC5]	Wind
82	Shaker	Shaker	Shaker	Seashore	
83	Jingle Bell	Jingle Bell	Jingle Bell	Stream	
C6	84	Bell Tree	Bell Tree	Bell Tree	Bubble
	85	Castanets	Castanets	Castanets	Cat
	86	Mute Surdo [EXC6]	Mute Surdo [EXC6]	Mute Surdo [EXC6]	----
	87	Open Surdo [EXC6]	Open Surdo [EXC6]	Open Surdo [EXC6]	----
88	----	----	Applause	----	

--- : no sound

[EXC] : will not sound simultaneously with other percussion instruments of the same number

Manual Percussion Set

	PERC.SET 1	PERC.SET 2	VOICE PHRASE
40	Crash Cymbal	Mallet Cymbal	Amen 1(Mid)
41	Snare Roll	Slap Stick	Amen 1(Hi1)
42	Concert Snare Drum	Ratchet	Amen 1(Hi2)
43	Concert Cymbal	Concert Cymbal	Amen 2(Mid)
44	Concert BD1	Concert BD2	Amen 2(Hi)
45	Jingle Bell	Bar Chime	Amen 3(Mid)
46	Metronome Bell	Finger Snap	Amen 3(Hi)
47	Timpani Roll	Timpani 2 (Low)	Aleluia 1(Mid)
C3 48	Timpani	Timpani 2 (Hi)	Aleluia 1(Hi)
49	Church Bell	Church Bell 2	Aleluia 2(Hi)
50	Big Gong	Church Bell 2 Loop	Aleluia 2(Mid)
51	Hand Clap	Castanet (One Shot)	Hey (Hi)
52	High Wood Block	Castanet	Hey (Mid)
53	Low Wood Block	Castanet (Loop)	Woo (Mid)
54	Tambourine	Tambourine 2	Woo (Hi)

Style List

[Big Band]

New Big Band
Fast BigBand
BigBandSwing
BigBndBallad
Jazz Band
Big Band
Big Band 2

[Swing]

A Cappella
Combo
Medium Swing
Slow Swing
Swing
Shuffle

[Country]

CountryPiano
CountryRoads
CountrySwing
Hoedown
Twostep
CountryWaltz
Easy Country

[Oldies]

Rock'n'Roll
Beach Sound
Twist
Slow Dance
Dreamin'
50's Pop 1

[Ballad]

Love Songs
Torch Song
MediumBallad
Love Romance
Ballad
Classic

[Trad]

Dixieland
Polka
Foxtrot
Charleston
PianoBoogie1

[Acoustic]

G.Pop
G.Fast Pop
P.Slow
P.Jazz
G.Shuffle
P.Night

[World]

Hawaiian
French Waltz
D Marsch 6/8
Scotland
Ireland
Reggae

[Latin1]

Bossa Nova
Bossa Nova 2
FastBosaNova
Slow Bossa
Chacha
Salsa

[Latin2]

Rhumba
Beguine
Mambo
Tango 1
Tango 2
Samba Rio

Style List

[Showtime]

Screen 1
Screen 2
Music Hall
Broadway
ChooChooSwg
Raindrops
Festival

[Waltz/March]

Jazz Waltz
Last Dance
StringsWaltz
Slow Waltz
Musette
March 4/4
March 6/8

[Pop1]

8Beat Pop
Swing Pop
PopularPiano
Acoustic Pop
Easy Listen1
Easy Listen2

[Disk]

Cute Pop
60'sBallad
Bossa Nova 3
Bossa Nova 4
16Beat Pop 1
16Beat Pop 2

[Pop2]

Rollin'
Motown
ShufflePop 1
ShufflePop 2
Rock'n Pop

[Gospel]

Gospel Pop
Gospel 1
Anthem
Revival

Rhythm List (Music Style Disk)

■ [Disk 1]

01 BigBndBalld2
 02 Standard
 03 Blues 2
 04 Blues 3
 05 Boogie
 06 Big Band 4
 07 MidiumSwing2
 08 Slow Swing 2
 09 Five
 10 Bluegrass 1
 11 Bluegrass 2
 12 Slow Country
 13 ContryBallad
 14 ContryWaltz2
 15 Two Step 2
 16 Train Beat
 17 Twist 2
 18 Slow Rock 2
 19 Baroque
 20 Ballad 2
 21 Ballad 3
 22 Dixieland 2
 23 Ragtime 2
 24 Macarena
 25 Miami
 26 Merenge
 27 Tequila
 28 Hawaiian 2
 29 Bossa Nova 5
 30 Chacha 3
 31 Salsa 2
 32 Mambo 2
 33 Samba 2
 34 Tango 3
 35 Tango 4
 36 Beguine 2
 37 Easy Listen6
 38 Easy Listen7
 39 Gt.Arpeggio1
 40 ThreeFinger1

41 Pop Piano
 42 Folk Waltz
 43 Slow Waltz 2
 44 Swing Waltz
 45 Jazz Waltz 2
 46 8Beat Enka
 47 16Beat Enka
 48 R&B 2
 49 Rock'n'Roll2
 50 Rock'n'Roll3
 51 Schlager 1
 52 Contemp 1
 53 Contemp 2
 54 Contemp 3
 55 Funk 1

■ [Disk 2]

01 Cajun
 02 Western
 03 Sevilla
 04 Easy Listen3
 05 Easy Listen4
 06 Easy Listen5
 07 Gospel 2
 08 GospelBallad
 09 Vienna Waltz
 10 March 2/4
 11 SimpleMarch2
 12 Rock 1
 13 Rock 2
 14 Dance Pop 1
 15 Dance Pop 2
 16 Dance Pop 3
 17 Dance Pop 4

Settings That Are Stored After the Power Is Turned Off

Settings That Are Stored After the Power Is Turned Off

Panel Settings

The [Chorus] button (ON/OFF)

Effect Menu

Rotary Speed

Rotary Color

Function Menu

Metronome Sound

Utility Menu

Registration Shift

Registration Arranger Update

Registration Transpose Update

Expression Curve

TX MIDI Channel (only the MIDI Output channel of the

Control track)

MIDI In Mode

Send PC Switch

Master Tune

LCD Contrast

Settings That Are Stored in the Registration Buttons

Panel Settings

Registration Name

Selected Rhythms for each Rhythm group button

Utility Menu

Registration Shift

Registration Arranger Update

Registration Transpose Update

Settings That Are Stored in the Individual Registration Buttons

Panel Settings

Solo [To Lower] button (ON/OFF)

[Bass Split] button (ON/OFF)

Bass [To Lower] button (ON/OFF)

[Manual Drums] button (ON/OFF)

[Manual Percussion] button (ON/OFF)

The Voices assigned for each part

The Reverb depth for each part

The Chorus settings (ON/OFF) of the voices for each part

The voices assigned to the [Others] buttons for each part

[Harmony Intelligence] button (ON/OFF)

Rotary [Fast/Slow] button (ON/OFF)

Sustain buttons (ON/OFF)

Rhythm Type

[Intro/Ending] button (ON/OFF)

[Sync Start] button (ON/OFF)

[Advanced] button (ON/OFF)

[Variation] button (ON/OFF)

[Chord Intelli] button (ON/OFF)

[Leading Bass] button (ON/OFF)

Part Balance [▲] [▼] buttons settings (Part Balance

Volume)

Rotary [ON/OFF] button (ON/OFF)

Arranger [ON/OFF] button (ON/OFF)

Lower Voice [Hold] button (ON/OFF)

Transpose setting

Tempo setting

Effect Menu

Reverb Type

Sustain Length

Utility Menu

Initial Touch ON/OFF

Pedal Bass Mode

Solo Mode

Left Foot Switch Assignment

Right Foot Switch Assignment

Damper Pedal Assignment

Pitch Bend Range

Manual Drums Set

Manual Percussion Set

Harmony Intelligence Type

Solo To Lower Mode

Solo Split Point

Bass Split Point

Chord Hold (ON/OFF)

Tx MIDI Channel (Upper, Lower, Pedal, Solo)

PC Number (Bank Select)









































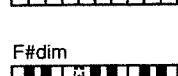
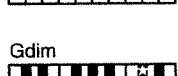
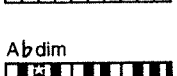

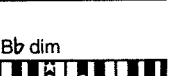

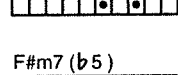
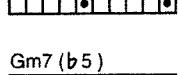
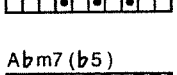
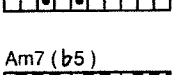
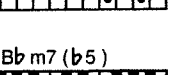
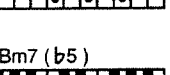
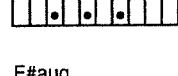
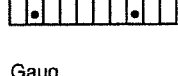
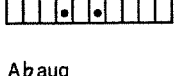
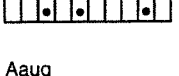
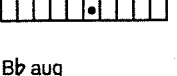
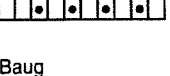
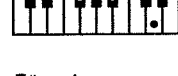
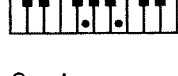
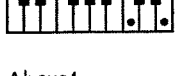
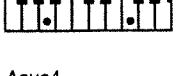
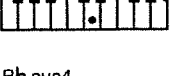
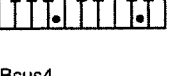



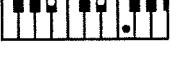



Chord List

● symbol : Indicates the constituent note of chords.

★ symbol : Chord shown with an "★" can be played by pressing just the key marked with the "★".

C	C#	D	E \flat	E	F
CM7	C#M7	DM7	E \flat M7	EM7	FM7
C7	C#7	D7	E \flat 7	E7	F7
Cm	C#m	Dm	E \flat m	Em	Fm
Cm7	C#m7	Dm7	E \flat m7	Em7	Fm7
Cdim	C#dim	Ddim	E \flat dim	Edim	Fdim
Cm7 (b5)	C#m7 (b5)	Dm7 (b5)	E \flat m7 (b5)	Em7 (b5)	Fm7 (b5)
Caug	C#aug	Daug	E \flat aug	Eaug	Faug
Csus4	C#sus4	Dsus4	E \flat sus4	Esus4	Fsus4
C7sus4	C#7sus4	D7sus4	E \flat 7sus4	E7sus4	F7sus4
C6	C#6	D6	E \flat 6	E6	F6
Cm6	C#m6	Dm6	E \flat m6	Em6	Fm6

Chord List

Glossary

Arrangement

This refers to changes that have been made in an original tune, by adding a new accompaniment or by changing the instruments used.

Automatic Accompaniment

Automatic Accompaniment is automatic accompaniment when just a few keys in the lower section of the keyboard are pressed to specify the chord.

Basic Chord

This refers to the most commonly used types of chord, which are generally the following six types: major chords, minor chords, minor seventh chords, minor seventh (b5) chords, dominant seventh chords, and diminished seventh chords.

Chord

Notes of two or more pitches sounded simultaneously.

Chords consisting of three notes are called "triads," and are the most basic type of chord.

Chorus

An effect that adds spaciousness and richness to the sound.

Ending

This is the last part of the accompaniment. When you stop playing the Automatic Accompaniment, the AT-60R plays an Ending appropriate for the Rhythm.

Glide

An effect that temporarily lowers the pitch and then gradually returns it to normal.

Intro

This is the introductory portion of an Automatic Accompaniment performance. The AT-60R plays an intro ideally suited to each Rhythm when it starts playing the Automatic Accompaniment.

Inversion

When the lowest note of a chord is the root, the chord is said to be in "root position." In contrast, forms of a chord in which other notes are the lowest pitch are called "inversions."

Mute

To silence a sound. The AT-60R provides a Track Mute function that allows you to turn off the track button indicator of a track on which music data has been recorded, so that the corresponding track will temporarily be silenced.

Panel Settings

Settings such as sound selections, tempo, Rotary fast/slow.

Pitch Bend

An effect that smoothly raises or lowers the pitch.

Registration

A unit of data that contains the performance state of the instrument, such as sound selections and panel settings.

Reverb

An effect that simulates the reverberation of a room or concert hall.

Root Note

The root note is the basis of a chord. All chords are built on a root note, which is the part of the chord name given in uppercase letters.

Rotary

An effect which simulates the modulation given to the sound when a rotating speaker is used. The Rotary effect produces two types of modulation: fast or slow.

Split

A function which allows the keyboard to be divided into two or more areas, and a different sound assigned to each area. The point at which the keyboard is divided is called the "Split Point."

Sustain

An effect that adds a decay to each note. The AT-60R allows sustain to be applied to the voices of the upper part, lower part, and pedal part.

Vibrato

An effect that cyclically modulates the pitch.

Voice

The AT-60R is able to produce the sounds of various instruments. These sounds are called "Voices."

About ATELIER Series Sound Generator

The ATELIER series come equipped with GM / GS sound generators.

General GM System

The General MIDI system is a set of recommendations which seeks to provide a way to go beyond the limitations of proprietary designs, and standardize the MIDI capabilities of sound generating devices. Sound generating devices and music data that meets the General MIDI standard bears the General MIDI logo. Music data bearing the General MIDI logo can be played back using any General MIDI sound generating unit to produce essentially the same musical performance.

GS format

The GS Format is Roland's set of specifications for standardizing the performance of sound generating devices. In addition to including support for everything defined by the General MIDI System, the highly-compatible GS Format additionally offers an expanded number of sounds, provides for the editing of sounds, and spells out many details for a wide range of extra features, including effects such as reverb and chorus.

Designed with the future in mind, the GS Format can readily include new sounds and support new hardware features when they arrive.

Since it is upwardly compatible with the General MIDI System, Roland's GS Format is capable of reliably playing back GM Scores equally as well as it performs GS Music Data (music data that has been created with the GS Format in mind).

This product supports both the General MIDI system and the GS format, and can be used to play back music data carrying either of these logos.

MIDI IMPLEMENTATION

Model: AT-60R
Date: Mar. 1, 1999
Version: 1.00

1. Receive data

■ Channel Voice Messages

● Note off

Status	2nd byte	3rd byte
8nH	kkH	vvH
9nH	kkH	00H

n = MIDI channel number: 0H-FH (ch.1-ch.16)
kk = note number: 00H-7FH (0-127)
vv = note off velocity: 00H-7FH (0-127)

- For Drum Parts, these messages are received when Rx.NOTE OFF = ON for each Instrument.
- The velocity values of Note Off messages are ignored.

● Note on

Status	2nd byte	3rd byte
9nH	kkH	vvH

n = MIDI channel number: 0H-FH (ch.1-ch.16)
kk = note number: 00H-7FH (0-127)
vv = note on velocity: 01H-7FH (1-127)

- Not received when Rx.NOTE MESSAGE = OFF. (Initial value is ON)
- For Drum Parts, not received when Rx.NOTE ON = OFF for each Instrument.

● Polyphonic Key Pressure

Status	2nd byte	3rd byte
AnH	kkH	vvH

n = MIDI channel number: 0H-FH (ch.1-ch.16)
kk = note number: 00H-7FH (0-127)
vv = key pressure: 00H-7FH (0-127)

- Not received when Rx.POLY PRESSURE (PAF) = OFF. (Initial value is ON)
- The resulting effect is determined by System Exclusive messages. With the initial settings, there will be no effect.
- Not Received in Keyboard Part.

● Control Change

- When Rx.CONTROL CHANGE = OFF, all control change messages except for Channel Mode messages will be ignored.
- The value specified by a Control Change message will not be reset even by a Program Change, etc.

○ Bank Select (Controller number 0, 32)

Status	2nd byte	3rd byte
BnH	00H	mmH
BnH	20H	llH

n = MIDI channel number: 0H-FH (ch.1-ch.16)
mm, ll = Bank number: 00H, 00H-7FH, 7FH (bank.1-bank.16384), Initial Value = 00 00H (bank.1)

- Not received when Rx.BANK SELECT = OFF. "Rx.BANK SELECT" is set to OFF by "Turn General MIDI System On," and set to ON by "GS RESET." (Power-on default value is ON.)
- Bank Select processing will be suspended until a Program Change message is received.
- The GS format "Variation number" is the value of the Bank Select MSB (Controller number 0) expressed in decimal.
- Not Received in Keyboard Part.

○ Modulation (Controller number 1)

Status	2nd byte	3rd byte
BnH	01H	vvH

n = MIDI channel number: 0H-FH (ch.1-ch.16)
vv = Modulation depth: 00H-7FH (0-127)

- Not received when Rx.MODULATION = OFF. (Initial value is ON)
- The resulting effect is determined by System Exclusive messages. With the initial settings, this is Pitch Modulation Depth.

○ Portamento Time (Controller number 5)

Status	2nd byte	3rd byte
BnH	05H	vvH

n = MIDI channel number: 0H-FH (ch.1-ch.16)
vv = Portamento Time: 00H-7FH (0-127), Initial value = 00H (0)

- This adjusts the rate of pitch change when Portamento is ON or when using the Portamento Control. A value of 0 results in the fastest change.

○ Data Entry (Controller number 6, 38)

Status	2nd byte	3rd byte
BnH	06H	mmH
BnH	26H	llH

n = MIDI channel number: 0H-FH (ch.1-ch.16)
mm, ll = the value of the parameter specified by RPN/NRPN

○ Volume (Controller number 7)

Status	2nd byte	3rd byte
BnH	07H	vvH

n = MIDI channel number: 0H-FH (ch.1-ch.16)
vv = Volume: 00H-7FH (0-127), Initial Value = 64H (100)

- Volume messages are used to adjust the volume balance of each Part.
- Not received when Rx.VOLUME = OFF. (Initial value is ON)
- Not Received in Keyboard Part.

○ Pan (Controller number 10)

Status	2nd byte	3rd byte
BnH	0AH	vvH

n = MIDI channel number: 0H-FH (ch.1-ch.16)
vv = pan: 00H-40H-7FH (Left-Center-Right), Initial Value = 40H (Center)

- For Rhythm Parts, this is a relative adjustment of each Instrument's pan setting.
- Not received when Rx.PANPOT = OFF. (Initial value is ON)
- Not Received in Keyboard Part.

○ Expression (Controller number 11)

Status	2nd byte	3rd byte
BnH	0BH	vvH

n = MIDI channel number: 0H-FH (ch.1-ch.16)
vv = Expression: 00H-7FH (0-127), Initial Value = 7FH (127)

- It can be used independently from Volume messages. Expression messages are used for musical expression within a performance; e.g., expression pedal movements, crescendo and decrescendo.
- Not received when Rx.EXPRESSION = OFF. (Initial value is ON)
- Not Received in Keyboard Part.

○ Glide (Controller number 16)

Status	2nd byte	3rd byte
BnH	10H	vvH

n = MIDI channel number: 0H-FH (ch.1-ch.16)
vv = Control value: 00H-7FH (0-127) 0-63 = OFF, 64-127 = ON

- It can be used on only keyboard part. Not received on GS part.

○ Hold 1 (Controller number 64)

Status	2nd byte	3rd byte
BnH	40H	vvH

n = MIDI channel number: 0H-FH (ch.1-ch.16)
vv = Control value: 00H-7FH (0-127)

- Not received when Rx.HOLD1 = OFF. (Initial value is ON)

○ Portamento (Controller number 65)

Status	2nd byte	3rd byte
BnH	41H	vvH

n = MIDI channel number: 0H-FH (ch.1-ch.16)
vv = Control value: 00H-7FH (0-127) 0-63 = OFF, 64-127 = ON

- Not received when Rx.PORTAMENTO = OFF. (Initial value is ON)

○Sostenuto (Controller number 66)

Status	2nd byte	3rd byte
BnH	42H	vvH

n = MIDI channel number: 0H-FH (ch.1-ch.16)
 vv = Control value: 00H-7FH (0-127) 0-63 = OFF, 64-127 = ON

- Not received when Rx.SOSTENUTO = OFF. (Initial value is ON)
- Not Received in Keyboard Part.

○Soft (Controller number 67)

Status	2nd byte	3rd byte
BnH	43H	vvH

n = MIDI channel number: 0H-FH (ch.1-ch.16)
 vv = Control value: 00H-7FH (0-127) 0-63 = OFF, 64-127 = ON

- Not received when Rx.SOFT = OFF. (Initial value is ON)
- Not Received in Keyboard Part.

○Portamento control (Controller number 84)

Status	2nd byte	3rd byte
BnH	54H	kkH

n = MIDI channel number: 0H-FH (ch.1-ch.16)
 kk = source note number: 00H-7FH (0-127)

- A Note-on received immediately after a Portamento Control message will change continuously in pitch, starting from the pitch of the Source Note Number.
- If a voice is already sounding for a note number identical to the Source Note Number, this voice will continue sounding (i.e., legato) and will, when the next Note-on is received, smoothly change to the pitch of that Note-on.
- The rate of the pitch change caused by Portamento Control is determined by the Portamento Time value.

Example 1.

On MIDI (Description)	Result
90 3C 40 (Note on C4)	C4 on
B0 54 3C (Portamento Control from C4)	no change (C4 voice still sounding)
90 40 40 (Note on E4)	glide from C4 to E4
80 3C 40 (Note off C4)	no change
80 40 40 (Note off E4)	E4 off

Example 2.

On MIDI (Description)	Result
B0 54 3C (Portamento Control from C4)	no change
90 40 40 (Note on E4)	E4 is played with glide from C4 to E4
80 40 40 (Note off E4)	E4 off

○Effect 1 (Reverb Send Level) (Controller number 91)

Status	2nd byte	3rd byte
BnH	5BH	vvH

n = MIDI channel number: 0H-FH (ch.1-ch.16)
 vv = Control value: 00H-7FH (0-127), Initial Value = 28H (40)

- This message adjusts the Reverb Send Level of each Part.
- Not Received in Keyboard Part.

○Effect 3 (Chorus Send Level) (Controller number 93)

Status	2nd byte	3rd byte
BnH	5DH	vvH

n = MIDI channel number: 0H-FH (ch.1-ch.16)
 vv = Control value: 00H-7FH (0-127), Initial Value = 00H (0)

- This message adjusts the Chorus Send Level of each Part.
- Not Received in Keyboard Part.

○NRPN MSB/LSB (Controller number 98, 99)

Status	2nd byte	3rd byte
BnH	63H	mmH
BnH	62H	llH

n = MIDI channel number: 0H-FH (ch.1-ch.16)
 mm = upper byte of the parameter number specified by NRPN
 ll = lower byte of the parameter number specified by NRPN

- NRPN can be received when Rx.NRPN = ON. "Rx.NRPN" is set to OFF by power-on reset or by receiving "Turn General MIDI System On," and it is set to ON by "GS RESET."
- The value set by NRPN will not be reset even if Program Change or Reset All Controllers is received.
- Not Received in Keyboard Part.

NRPN

The NRPN (Non Registered Parameter Number) message allows an extended range of control changes to be used.

To use these messages, you must first use NRPN MSB and NRPN LSB messages to specify the parameter to be controlled, and then use Data Entry messages to specify the value of the specified parameter. Once an NRPN parameter has been specified, all Data Entry messages received on that channel will modify the value of that parameter. To prevent accidents, it is recommended that you set RPN Null (RPN Number = 7FH/7FH) when you have finished setting the value of the desired parameter. Refer to Section 4, Supplementary material "Examples of actual MIDI messages" <Example 4> (p. 147). On the GS devices, Data entry LSB (llH) of NRPN is ignored, so it is no problem to send Data entry MSB (mmH) only (without Data entry LSB).

On the AT-60R, NRPN can be used to modify the following parameters.

NRPN MSB LSB	Data entry MSB	Description
01H 08H	mmH	Vibrato rate (relative change on specified channel) mm: 0EH-40H-72H (-50 - 0 - +50)
01H 09H	mmH	Vibrato depth (relative change on specified channel) mm: 0EH-40H-72H (-50 - 0 - +50)
01H 0AH	mmH	Vibrato delay (relative change on specified channel) mm: 0EH-40H-72H (-50 - 0 - +50)
01H 20H	mmH	TVF cutoff frequency (relative change on specified channel) mm: 0EH-40H-72H (-50 - 0 - +50)
01H 21H	mmH	TVF resonance (relative change on specified channel) mm: 0EH-40H-72H (-50 - 0 - +50)
01H 63H	mmH	TVF&TVA Env. Attack time (relative change on specified channel) mm: 0EH-40H-72H (-50 - 0 - +50)
01H 64H	mmH	TVF&TVA Env. Decay time (relative change on specified channel) mm: 0EH-40H-72H (-50 - 0 - +50)
01H 66H	mmH	TVF&TVA Env. Release time (relative change on specified channel) mm: 0EH-40H-72H (-50 - 0 - +50)
18H rrH	mmH	Pitch coarse of drum instrument (relative change on specified drum instrument) rr: key number of drum instrument mm: 00H-40H-7FH (-63 - 0 - +63 semitone)
1AH rrH	mmH	TVA level of drum instrument (absolute change on specified drum instrument) r: key number of drum instrument mm: 00H-7FH (zero-maximum)
1CH rrH	mmH	Panpot of drum instrument (absolute change on specified drum instrument) rr: key number of drum instrument mm: 00H, 01H-40H-7FH (Random, Left-Center-Right)
1DH rrH	mmH	Reverb send level of drum instrument (absolute change on specified drum instrument) rr: key number of drum instrument mm: 01H-7FH (zero-maximum)
1EH rrH	mmH	Chorus send level of drum instrument (absolute change on specified drum instrument) rr: key number of drum instrument mm: 01H-7FH (zero-maximum)

- Parameters marked "relative change" will change relative to the preset value.
- Parameters marked "absolute change" will be set to the absolute value of the parameter, regardless of the preset value.

○RPN MSB/LSB (Controller number 100, 101)

Status	2nd byte	3rd byte
BnH	65H	mmH
BnH	64H	llH

n = MIDI channel number: 0H-FH (ch.1-ch.16)
 mm = upper byte of parameter number specified by RPN
 ll = lower byte of parameter number specified by RPN

- Not received when Rx.RPN = OFF. (Initial value is ON)
- The value specified by RPN will not be reset even by messages such as Program Change or Reset All Controller.

RPN

The RPN (Registered Parameter Number) messages are expanded control changes, and each function of an RPN is described by the MIDI Standard.

To use these messages, you must first use RPN MSB and RPN LSB messages to specify the parameter to be controlled, and then use Data Entry messages to specify the value of the specified parameter. Once an RPN parameter has been specified, all Data Entry messages received on that channel will modify the value of that parameter. To prevent accidents, it is recommended that you set RPN Null (RPN Number = 7FH/7FH) when you have finished setting the value of the desired parameter. Refer to Section 4. "Examples of actual MIDI messages" <Example 4> (p. 147).

On the AT-60R, RPN can be used to modify the following parameters.

RPN	Data entry	Explanation
<u>MSB LSB</u> 00H 00H	<u>MSB LSB</u> mmH ---	Pitch Bend Sensitivity mm: 00H-18H (0-24 semitones), Initial Value = 02H (2 semitones) ll: ignored (processed as 00h) specify up to 2 octaves in semitone steps
00H 01H	mmH llH	Master Fine Tuning mm, ll: 00 00H - 40 00H - 7F 7FH (-100 - 0 - +99.99 cents), Initial Value = 40 00H (0 cent) ll: ignored (processed as 00h) specify up to 2 octaves in semitone steps Refer to 4. Supplementary material, "About tuning" (p. 148)
00H 02H	mmH ---	Master Coarse Tuning mm: 28H - 40H - 58H (-24 - 0 - +24 semitones), Initial Value = 40H (0 cent) ll: ignored (processed as 00h)
7FH 7FH	--- ---	RPN null Set condition where RPN and NRPN are unspecified. The data entry messages after set RPN null will be ignored. (No Data entry messages are required after RPN null). Settings already made will not change. mm, ll: ignored

●Program Change

Status	2nd bytes
CnH	ppH

n = MIDI channel number: 0H-FH (ch.1-ch.16)
pp = Program number: 00H-7FH (prog.1-prog.128)

- * Not received when Rx.PROGRAM CHANGE = OFF. (Initial value is ON)
- * After a Program Change message is received, the sound will change beginning with the next Note-on. Voices already sounding when the Program Change message was received will not be affected.
- * For Drum Parts, Program Change messages will not be received on bank numbers 129-16384 (the value of Control Number 0 is other than 0 (00H)).
- * When MIDI-IN Mode = Mode-2, it should be used System Exclusive messages to change the voice of keyboard part (p. 142).
- * Not Received in Keyboard Part.

●Channel Pressure

Status	2nd bytes
DnH	vvH

n = MIDI channel number: 0H-FH (ch.1-ch.16)
vv = Channel Pressure: 00H-7FH (0-127)

- * Not received when Rx.CH PRESSURE (CA) = OFF. (Initial value is ON)
- * The resulting effect is determined by System Exclusive messages. With the initial settings there will be no effect. The initial setting of Keyboard part id Vibrato depth. It can not be changed.

●Pitch Bend Change

Status	2nd byte	3rd bytes
EnH	llH	mmH

n = MIDI channel number: 0H-FH (ch.1-ch.16)
mm, ll = Pitch Bend value: 00 00H - 40 00H - 7F 7FH (-8192 - 0 - +8191)

- * Not received when Rx.PITCH BEND = OFF. (Initial value is ON)
- * The resulting effect is determined by System Exclusive messages. With the initial settings the effect is Pitch Bend.

■Channel Mode Messages

●All Sounds Off (Controller number 120)

Status	2nd byte	3rd bytes
BnH	78H	00H

n = MIDI channel number: 0H-FH (ch.1-ch.16)

- * When this message is received, all currently-sounding notes on the corresponding channel will be turned off immediately.

●Reset All Controllers (Controller number 121)

Status	2nd byte	3rd bytes
BnH	79H	00H

n = MIDI channel number: 0H-FH (ch.1-ch.16)

- * When this message is received, the following controllers will be set to their reset values.

Controller	Reset value
Pitch Bend Change	+-0 (Center)
Polyphonic Key Pressure	0 (off)
Channel Pressure	0 (off)
Modulation	0 (off)
Expression	127 (max)
Hold 1	0 (off)
Portamento	0 (off)
Sostenuto	0 (off)
Soft	0 (off)
RPN	unset; previously set data will not change
NRPN	unset; previously set data will not change

●All Notes Off (Controller number 123)

Status	2nd byte	3rd bytes
BnH	7BH	00H

n = MIDI channel number: 0H-FH (ch.1-ch.16)

- * When All Notes Off is received, all notes on the corresponding channel will be turned off. However if Hold 1 or Sostenuto is ON, the sound will be continued until these are turned off.

●OMNI OFF (Controller number 124)

Status	2nd byte	3rd bytes
BnH	7CH	00H

n = MIDI channel number: 0H-FH (ch.1-ch.16)

- * The same processing will be carried out as when All Notes Off is received.
- * Not Received in Keyboard Part.

●OMNI ON (Controller number 125)

Status	2nd byte	3rd bytes
BnH	7DH	00H

n = MIDI channel number: 0H-FH (ch.1-ch.16)

- * OMNI ON is only recognized as "All notes off"; the Mode doesn't change (OMNI OFF remains).

●MONO (Controller number 126)

Status	2nd byte	3rd bytes
BnH	7EH	mmH

n = MIDI channel number: 0H-FH (ch.1-ch.16)
mm = mono number: 00H-10H (0-16)

- * The same processing will be carried out as when All Sounds Off and All Notes Off is received, and the corresponding channel will be set to Mode 4 (M = 1) regardless of the value of "mono number."
- * Not Received in Keyboard Part.

●POLY (Controller number 127)

Status	2nd byte	3rd bytes
BnH	7FH	00H

n = MIDI channel number: 0H-FH (ch.1-ch.16)

- * The same processing will be carried out as when All Sounds Off and All Notes Off is received, and the corresponding channel will be set to Mode 3.

■System Realtime Message

●Active Sensing

Status
FEH

- * When Active Sensing is received, the unit will begin monitoring the intervals of all further messages. While monitoring, if the interval between messages exceeds 420 ms, the same processing will be carried out as when All Sounds Off, All Notes Off and Reset All Controllers are received, and message interval monitoring will be halted.

■System Exclusive Message

Status	Data byte	Status
F0H	iiH, ddH,, eeH	F7H

F0H: System Exclusive Message status
 ii = ID number: an ID number (manufacturer ID) to indicate the manufacturer whose Exclusive message this is. Roland's manufacturer ID is 41H. ID numbers 7EH and 7FH are extensions of the MIDI standard; Universal Non-realtime Messages (7EH) and Universal Realtime Messages (7FH).
 dd, ..., ee = data: 00H-7FH (0-127)
 F7H: EOX (End Of Exclusive)

The System Exclusive Messages received by the AT-60R are: messages related to mode settings, Universal Realtime System Exclusive messages and Data Set (DT1).

●System exclusive messages related to mode settings

These messages are used to initialize a device to GS or General MIDI mode, or change the operating mode. When creating performance data, a "Turn General MIDI System On" message should be inserted at the beginning of a General MIDI score, and a "GS Reset" message at the beginning of a GS music data. Each song should contain only one mode message as appropriate for the type of data. (Do not insert two or more mode setting messages in a single song.)
 "Turn General MIDI System On and "Turn General MIDI System Off" use Universal Non-realtime Message format. "GS Reset" use Roland system exclusive format "Data Set 1 (DT1)."

○Turn General MIDI System On

This is a command message that resets the internal settings of the unit to the General MIDI initial state (General MIDI System-Level 1). After receiving this message AT-60R, will automatically be set to the proper condition for correctly playing a General MIDI score.

Status	Data byte	Status
F0H	7EH, 7FH, 09H, 01H	F7H

Byte	Explanation
F0H	Exclusive status
7EH	ID number (Universal Non-realtime Message)
7FH	Device ID (Broadcast)
09H	Sub ID#1 (General MIDI Message)
01H	Sub ID#2 (General MIDI On)
F7H	EOX (End Of Exclusive)

- * When this message is received, Rx.BANK SELECT will be OFF and Rx.NRPN will be OFF.
- * There must be an interval of at least 50 ms between this message and the next message.
- * Not Received in Keyboard Part.

○General MIDI System Off

Status	Data byte	Status
F0H	7EH, 7FH, 09H, 02H	F7H

Byte	Explanation
F0H	Exclusive status
7EH	ID number (Universal Non-realtime Message)
7FH	Device ID (Broadcast)
09H	sub-ID#1 (General MIDI message)
02H	sub-ID#2 (General MIDI Off)
40H	EOX (End of exclusive)

- * There must be an interval of at least 50 ms between this message and the next.
- * Not Received in Keyboard Part.

○GS reset

GS Reset is a command message that resets the internal settings of a device to the GS initial state. This message will appear at the beginning of GS music data, and a GS device that receives this message will automatically be set to the proper state to correctly playback GS music data.

Status	Data byte	Status
F0H	41H, 10H, 42H, 12H, 40H, 00H, 7FH, 00H, 41H	F7H

Byte	Explanation
F0H	Exclusive status
41H	ID number (Roland)
10H	Device ID (dev: 00H-1FH (1-32), Initial value is 10H (17))
42H	Model ID (GS)
12H	Command ID (DT1)
40H	Address MSB
00H	Address
7FH	Address LSB
00H	Data (GS reset)
41H	Checksum
F7H	EOX (End Of Exclusive)

- * When this message is received, Rx.NRPN will be ON.
- * There must be an interval of at least 50 ms between this message and the next.
- * Not Received in Keyboard Part.

○Exit GS mode

Status	Data byte	Status
F0H	41H, 10H, 42H, 12H, 40H, 00H, 7FH, 7FH, 42H	F7H

Byte	Explanation
F0H	Exclusive status
41H	ID number (Roland)
10H	Device ID
42H	Model ID (GS)
12H	Command ID (DT1)
40H	Address MSB
00H	Address
:	
7FH	Address LSB
7FH	Data (Exit GS mode)
42H	Checksum
F7H	EOX (End of exclusive)

- * There must be an interval of at least 50 ms between this message and the next.
- * Not Received in Keyboard Part.

●Universal Realtime System Exclusive Messages

○Master volume

Status	Data byte	Status
F0H	7FH, 7FH, 04H, 01H, 11H, mmH	F7H

Byte	Explanation
F0H	Exclusive status
7FH	ID number (universal realtime message)
7FH	Device ID (Broadcast)
04H	Sub ID#1 (Device Control messages)
01H	Sub ID#2 (Master Volume)
11H	Master volume lower byte
mmH	Master volume upper byte
F7H	EOX (End Of Exclusive)

- * The lower byte (11H) of Master Volume will be handled as 00H.

○Identity Request Message

Status	Data byte	Status
F0H	7FH, 10H, 06H, 01H	F7H

Byte	Explanation
F0H	Exclusive status
7FH	ID number (universal realtime message)
10H	Device ID
06H	Sub ID#1 (General Information)
01H	Sub ID#2 (Identity Request)
F7H	EOX (End Of Exclusive)

- * The "dev" is own device number or 7FH (Broadcast)

●Data transmission

AT-60R can receive the various parameters using System Exclusive messages. The exclusive message of GS format data has a model ID of 42H and a device ID of 10H (17), and it is common to all the GS devices. When keyboard part in MIDI-IN Mode: Mode-2, the exclusive message has a model ID of 62H and a device ID of 10H (17).

○Data set 1DT1

This is the message that actually performs data transmission, and is used when you wish to transmit the data.

Status	Data byte	Status
F0H	41H, 10H, iiH, 12H, aaH, bbH, ccH, ddH, ... eeH, sum	F7H

Byte	Explanation
F0H	Exclusive status
41H	ID number (Roland)
10H	Device ID
iiH	Model ID (GS Part:42H, Keyboard Part:62H)
12H	Command ID (DT1)
aaH	Address MSB: upper byte of the starting address of the transmitted data
bbH	Address: middle byte of the starting address of the transmitted data
ccH	Address LSB: lower byte of the starting address of the transmitted data
ddH	Data: the actual data to be transmitted. Multiple bytes of data are transmitted starting from the address.
:	
:	
eeH	Data
sum	Checksum
F7H	EOX (End Of Exclusive)

- * The amount of data that can be transmitted at one time depends on the type of data, and data can be received only from the specified starting address and size. Refer to the Address and Size given in Section 3 (p. 141).
- * Data larger than 128 bytes must be divided into packets of 128 bytes or less. If "Data Set 1" is transmitted successively, there must be an interval of at least 40 ms between packets.
- * Regarding the checksum please refer to section 4 (p. 148).

2. Transmit data

Arranger and composer data can not be transmitted.

■Channel Voice Messages

●Note off

○Upper Keyboard

Status	2nd byte	3rd byte
8nH	kkH	40H

n = MIDI channel number: 0H-FH (ch.1-ch.16)
: Initial Value = CH (ch.13)
kk = note number: 30H-60H (48-96)

- * Note off message is sent out with the velocity of 40H.

○Lower Keyboard

Status	2nd byte	3rd byte
8nH	kkH	40H

n = MIDI channel number: 0H-FH (ch.1-ch.16)
: Initial Value = BH (ch.12)
kk = note number: 24H-60H (48-96)

- * Note off message is sent out with the velocity of 40H.

○Bass Pedalboard

Status	2nd byte	3rd byte
8nH	kkH	40H

n = MIDI channel number: 0H-FH (ch.1-ch.16)
: Initial Value = DH (ch.14)
kk = note number: 24H-37H (36-55)

- * Note off message is sent out with the velocity of 40H.

●Note on

○Upper Keyboard

Status	2nd bytes	3rd byte
9nH	kkH	vvH

n = MIDI channel number: 0H-FH (ch.1-ch.16)
: Initial Value = CH (ch.13)
kk = note number: 30H-60H (48-96)
vv = note on velocity: 01H-7FH (1-127)

○Lower Keyboard

Status	2nd bytes	3rd byte
9nH	kkH	vvH

n = MIDI channel number: 0H-FH (ch.1-ch.16)
: Initial Value = BH (ch.12)
kk = note number: 24H-60H (36-96)
vv = note on velocity: 01H-7FH (1-127)

○Bass Pedalboard

Status	2nd bytes	3rd byte
9nH	kkH	vvH

n = MIDI channel number: 0H-FH (ch.1-ch.16)
: Initial Value = BH (ch.12)
kk = note number: 24H-37H (36-55)
vv = note on velocity: 01H-7FH (1-127)

●Control Change

○Bank Select (Controller number 0, 32)

Status	2nd bytes	3rd byte
BnH	00H	mmH
BnH	20H	llH

n = MIDI channel number: 0H-FH (ch.1-ch.16)
mm, ll = Bank number: 00H, 00H-7FH, 7FH (bank.1-bank.16384)

○Expression (Controller number 11)

Status	2nd byte	3rd byte
BnH	0BH	vvH
BnH	2BH	00H

n = MIDI channel number: 0H-FH (ch.1-ch.16)
 vv = Expression: 00H-7FH (0-127)

○Hold 1 (Controller number 64)

Status	2nd byte	3rd byte
BnH	40H	vvH

n = MIDI channel number: 0H-FH (ch.1-ch.16)
 vv = Control value: 00H-7FH (0-127)

●Program Change

Status	2nd byte
CnH	ppH

n = MIDI channel number: 0H-FH (ch.1-ch.16)
 pp = Program number: 00H-7FH (prog.1-prog.128)

■System Realtime Message

●Realtime Clock

Status
F8H

●Start

Status
FAH

●Continue

Status
FBH

●Stop

Status
FCH

* This will be transmitted constantly at intervals of approximately 250 ms.

■System exclusive messages

○Identity Reply (MIDI In Mode: Mode-1)

Status	Data byte	Status
F0H	7EH, 10H, 06H, 02H, 41H, 42H, 00H, 05H, 03H, 02H, 01H, 00H, 00H	F7H

Byte	Explanation
F0H	Exclusive status
7EH	ID number (universal non-realtime message)
10H	Device ID (use the same as the device ID of Roland)
06H	Sub ID#1 (General Information)
02H	Sub ID#2 (Identity Reply)
41H	ID number (Roland)
42H	Device family code (LSB)
00H	Device family code (MSB)
05H	Device family number code (LSB)
03H	Device family number code (MSB)
02H	Software revision level
01H	Software revision level
00H	Software revision level
00H	Software revision level
F7H	EOX (End of Exclusive)

○Identity Reply (MIDI In Mode: Mode-2)

Status	Data byte	Status
F0H	7EH, 10H, 06H, 02H, 41H, 02H, 00H, 00H, 01H, 00H, 01H, 00H, 00H	F7H

Byte	Explanation
F0H	Exclusive status
7EH	ID number (universal non-realtime message)
10H	Device ID (use the same as the device ID of Roland)
06H	Sub ID#1 (General Information)
02H	Sub ID#2 (Identity Reply)
41H	ID number (Roland)
02H	Device family code (LSB)
00H	Device family code (MSB)
00H	Device family number code (LSB)
01H	Device family number code (MSB)
00H	Software revision level
01H	Software revision level
00H	Software revision level
00H	Software revision level
F7H	EOX (End of Exclusive)

3. Parameter Address Map

This map indicates address, size, Data (range), Parameter, Description, and Default Value of parameters which can be transferred using and "Data set 1 (DT1)." All the numbers of address, size, Data, and Default Value are indicated in 7-bit Hexadecimal-form.

■Address Block map(GS Part: Model ID = 42H)

An outlined address map of the Exclusive Communication is as follows;

Address(H)	Block
40 00 00	SYSTEM PARAMETERS Individual
40 01 3F	
40 1x 00	PART PARAMETERS Individual
	{x = 0-F}
40 2x 5A	
41 m0 00	SRUM SETUP PARAMETERS Individual
	(m = 0-1)
41 m8 7F	
48 00 00	SYSTEM PARAMETERS Bulk
48 01 10	PART PARAMETERS Bulk
48 1D 0F	
49 m0 00	DRUM SETUP PARAMETER Bulk
	(m = 0-1)
49 mE 17	

There are two ways in which GS data is transmitted: Individual Parameter Transmission in which individual parameters are transmitted one by one, and Bulk Dump Transmission in which a large amount of data is transmitted at once.

■Individual Parameters

Individual Parameter Transmission transmits data (or requests data) for one parameter as one exclusive message (one packet of "F0 F7").

In Individual Parameter Transmission, you must use the Address and Size listed in the following "Parameter Address Map." Addresses marked at "#" cannot be used as starting addresses.

●System Parameters (Keyboard Part: Model ID = 62H)

Parameters related to the system of the device are called System Parameters.

00 00 00	00 00 01	00-07	REVERB MACRO	00: Room 1 01: Room 2 02: Room 3 03: Hall 1 04: Hall 2 05: Plate 06: Delay 07: Panning Delay	04	Hall 2
00 00 01#	00 00 01	00-7F	REVERB LEVEL	0-127	40	64
00 00 02	00 00 01	00-01	ROTARY ON/OFF	00:OFF/01:ON	01	ON
00 00 03	00 00 01	00-01	ROTARY SLOW/FAST	00:SLOW/01:FAST	01	Fast
00 00 20	00 00 01	00-01	CHORD INTELLIGENCE	00:OFF/01:ON	00	OFF
00 00 21	00 00 01	00-01	CHORD HOLD	00:OFF/01:ON	00	OFF
00 00 22	00 00 01	00-01	LEADING BASS	00:OFF/01:ON	00	OFF
00 00 23	00 00 01	00-7F	ACCOMP VOLUME	0-127	64	
00 00 24	00 00 01	00-7F	ACCOMP REVERB DEPTH	0-127	40	
00 00 25	00 00 01	00-7F	ACCOMP RHYTHM VOLUME	0-127	64	
00 00 26	00 00 01	00-7F	ACCOMP RHYTHM REVERB	0-127	40	
00 00 27	00 00 01	00-7F	ACCOMP BASS VOLUME	0-127	64	
00 00 28	00 00 01	00-7F	ACCOMP BASS REVERB	0-127	40	

●Part Parameters (Keyboard Part: Model ID = 62H)

○Upper Part Information

01 00 03	00 00 01	00-01	UPPER SUSTAIN SWITCH	00:OFF/01:ON	00	OFF
01 00 04	00 00 01	00-02	UPPER SUSTAIN LENGTH	00:SHORT 01:MIDDLE 02:LONG	02	LONG

p...PART NUMBER (0-2).

Organ Part	p = 1
Symphonic Part	p = 2
Orchestral Part	p = 3

01 0p 00	00 00 01	00-01	MUTE	00:OFF/01:MUTE	00	OFF
01 0p 01	00 00 03	00-7F	TONE NUMBER	P.C. VALUE	00	
01 0p 02#		00-7F	BANK SELECT MSB	CC#20 VALUE	00	
01 0p 03#		00-7F	BANK SELECT LSB	CC#00 VALUE	00	
01 0p 04	00 00 01	00-7F	VOLUME	0-127	64	
01 0p 05	00 00 01	00-7F	REVERB DEPTH	0-127	40	
01 0p 06	00 00 01	00-01	CHORUS SWITCH	00:OFF/01:ON	00	OFF
01 0p 07	00 00 01	28-58	KEY SHIFT	-24 - +24	40	

○Lower Part Information

01 10 00	00 00 01	00-01	LOWER HOLD	00:OFF/01:ON	00	OFF
01 10 03	00 00 01	00-01	LOWER SUSTAIN SWITCH	00:OFF/01:ON	00	OFF
01 10 04	00 00 01	00-02	LOWER SUSTAIN LENGTH	00:SHORT 01:MIDDLE 02:LONG	01	MIDDLE

p...PART NUMBER (0-2),

Organ Part p = 1
Symphonic Part p = 2
Orchestral Part p = 3

01 1p 00	00 00 01	00-01	MUTE	00:OFF/01:MUTE	00	OFF
01 1p 01	00 00 03	00-7F	TONE NUMBER	P.C. VALUE	00	
01 1p 02#		00-7F	BANK SELECT MSB	CC#20 VALUE	00	
01 1p 03#		00-7F	BANK SELECT LSB	CC#00 VALUE	00	
01 1p 04	00 00 01	00-7F	VOLUME	0-127	64	
01 1p 05	00 00 01	00-7F	REVERB DEPTH	0-127	40	
01 1p 06	00 00 01	00-01	CHORUS SWITCH	00:OFF/01:ON	00	OFF
01 1p 07	00 00 01	28-58	KEY SHIFT	-24 - +24	40	

○Pedal Bass Part Information

01 20 00	00 00 01	00-01	PEDAL BASS HOLD	00:OFF/01:ON	00	OFF
01 20 01	00 00 01	00-01	PEDAL BASS MODE	00:MONO/01:POLY	00	MONO
01 20 03	00 00 01	00-01	PEDAL SUSTAIN SWITCH	00:OFF/01:ON	01	ON
01 20 04	00 00 01	00-02	PEDAL SUSTAIN LENGTH	00:SHORT 01:MIDDLE 02:LONG	01	MIDDLE

p...PART NUMBER (0-2),

Organ Part p = 1
Orchestral Part p = 2

01 2p 00	00 00 01	00-01	MUTE	00:OFF/01:MUTE	00	OFF
01 2p 01	00 00 03	00-7F	TONE NUMBER	P.C. VALUE	00	
01 2p 02#		00-7F	BANK SELECT MSB	CC#20 VALUE	00	
01 2p 03#		00-7F	BANK SELECT LSB	CC#00 VALUE	00	
01 2p 04	00 00 01	00-7F	VOLUME	0-127	64	
01 2p 05	00 00 01	00-7F	REVERB DEPTH	0-127	40	
01 2p 07	00 00 01	28-58	KEY SHIFT	-24 - +24	40	

○Solo Part Information

01 30 01	00 00 01	00-01	SOLO MODE	00:MONO/01:POLY	00	MONO
01 30 02	00 00 01	00-01	SOLO TYPE	00:TOPNOTE/01:LASTNOTE	00	TOP NOTE
01 31 00	00 00 01	00-01	MUTE	00:OFF/01:MUTE	00	OFF
01 31 01	00 00 03	00-7F	TONE NUMBER	P.C. VALUE	00	
01 31 02#		00-7F	BANK SELECT MSB	CC#20 VALUE	00	
01 31 03#		00-7F	BANK SELECT LSB	CC#00 VALUE	00	
01 31 04	00 00 01	00-7F	VOLUME	0-127	64	
01 31 05	00 00 01	00-7F	REVERB DEPTH	0-127	40	
01 31 07	00 00 01	28-58	KEY SHIFT	-24 - +24	40	

○Manual Drum Part Information

01 41 00	00 00 01	00-01	MUTE	00:OFF/01:MUTE	00	OFF
01 41 01	00 00 03	00-7F	RHYTHM SET NUMBER	P.C. VALUE	00	
01 41 02#		00-7F	BANK SELECT MSB	CC#20 VALUE	00	
01 41 03#		00-7F	BANK SELECT LSB	CC#00 VALUE	00	
01 41 04	00 00 01	00-7F	VOLUME	0-127	64	
01 41 05	00 00 01	00-7F	REVERB DEPTH	0-127	40	

○Manual Percussion Part Information

01 51 00	00 00 01	00-01	MUTE	00:OFF/01:MUTE	00	OFF
01 51 01	00 00 03	00-7F	RHYTHM SET NUMBER	P.C. VALUE	00	
01 51 02#		00-7F	BANK SELECT MSB	CC#20 VALUE	00	
01 51 03#		00-7F	BANK SELECT LSB	CC#00 VALUE	00	
01 51 04	00 00 01	00-7F	VOLUME	0-127	64	
01 51 05	00 00 01	00-7F	REVERB DEPTH	0-127	40	

●System Parameters (GS Part: Model ID = 42H)

Parameters related to the system of the device are called System Parameters.

Address (H)	Size (H)	Data (H)	Parameter	Description	Default Value (H)	Description
40 00 00	00 00 04	0018-07E8	MASTER TUNE	-100.0 - +100.0 [cent]	00 04 00 00	0 [cent]
40 00 01#	Use nibblized data.					
40 00 02#						
40 00 03#						

* Refer to section 4. Supplementary material, "About tuning" (p. 148).

40 00 04	00 00 01	00-7F	MASTER VOLUME (= F0 7F 7F 04 01 00 vv F7)	0-127	7F	127
40 00 05	00 00 01	28-58	MASTER KEY-SHIFT	-24 - +24 [semitones]	40	0 [semitones]
40 00 06	00 00 01	01-7F	MASTER PAN	-63 (LEFT) - +63 (RIGHT)	40	0 (CENTER)
40 00 7F	00 00 01 (Rx. only)	00 127 = Exit GS	MODE SET ***	00 = GS Reset		

* Refer to "System exclusive messages related to Mode settings" (p. 138).

40 01 10	00 00 10	00-40	VOICE RESERVE	Part 10 (Drum Part)	02	2
40 01 11#	Part 1	06	6			
40 01 12#	Part 2	02	2			
40 01 13#	Part 3	02	2			
40 01 14#	Part 4	02	2			
40 01 15#	Part 5	02	2			
40 01 16#	Part 6	02	2			
40 01 17#	Part 7	02	2			
40 01 18#	Part 8	02	2			
40 01 19#	Part 9	02	2			
40 01 1A#	Part 11	00	0			
40 01 :#	:					
40 01 1F#	Part 16	00	0			

* The sum total of voices in the voice reserve function must be equal to or less than the number of the maximum polyphony. The maximum polyphony of the AT-60R is 64. For compatibility with other GS models, it is recommended that the maximum polyphony be equal or less than 24.

40 01 30	00 00 01	00-07	REVERB MACRO	00: Room 1 01: Room 2 02: Room 3 03: Hall 1 04: Hall 2 05: Plate 06: Delay 07: Panning Delay	04	Hall 2
40 01 31	00 00 01	00-07	REVERB CHARACTER	0-7	04	4
40 01 32	00 00 01	00-07	REVERB PRE-LPF	0-7	00	0
40 01 33	00 00 01	00-7F	REVERB LEVEL	0-127	40	64
40 01 34	00 00 01	00-7F	REVERB TIME	0-127	40	64
40 01 35	00 00 01	00-7F	REVERB DELAY FEEDBACK	0-127	00	0

* REVERB MACRO is a macro parameter that allows global setting of reverb parameters. When you select the reverb type with REVERB MACRO, each reverb parameter will be set to the most suitable value.

* REVERB CHARACTER is a parameter that changes the reverb algorithm. The value of REVERB CHARACTER corresponds to the REVERB MACRO of the same number.

40 01 38	00 00 01	00-07	CHORUS MACRO	00: Chorus 1 01: Chorus 2 02: Chorus 3 03: Chorus 4 04: Feedback Chorus 05: Flanger 06: Short Delay 07: Short Delay (FB)	02	Chorus 3
40 01 39	00 00 01	00-07	CHORUS PRE-LPF	0-7	00	0
40 01 3A	00 00 01	00-7F	CHORUS LEVEL	0-127	40	64
40 01 3B	00 00 01	00-7F	CHORUS FEEDBACK	0-127	08	8
40 01 3C	00 00 01	00-7F	CHORUS DELAY	0-127	50	80
40 01 3D	00 00 01	00-7F	CHORUS RATE	0-127	03	3
40 01 3E	00 00 01	00-7F	CHORUS DEPTH	0-127	13	19
40 01 3F	00 00 01	00-7F	CHORUS SEND LEVEL TO REVERB	0-127	00	0

* CHORUS MACRO is a macro parameter that allows global setting of chorus parameters. When you use CHORUS MACRO to select the chorus type, each chorus parameter will be set to the most suitable value.

●Part Parameters (GS Part: Model ID = 42H)

AT-60R has 16 parts. Parameters that can be set individually for each Part are called Part parameters.

If you use exclusive messages to set Part parameters, specify the address by Block number rather than Part Number (normally the same number as the MIDI channel). The Block number can be specified as one of 16 blocks, from 0 (H) to F (H).

The relation between Part number and Block number is as follows.

x...BLOCK NUMBER (0-F), Part 1 (MIDI ch = 1) x = 1
 Part 2 (MIDI ch = 2) x = 2
 :
 :
 Part 9 (MIDI ch = 9) x = 9
 Part10 (MIDI ch = 10) x = 0
 Part11 (MIDI ch = 11) x = A
 Part12 (MIDI ch = 12) x = B
 :
 :
 Part16 (MIDI ch = 16) x = F

Address (H)	Size (H)	Data (H)	Parameter	Description	Default Value (H)	Description
40 1x 00	00 00 02	00-7F	CC#00 VALUE	0-127	00	0
40 1x 01#	00-7F	P.C. VALUE 1-128	00	1		
40 1x 02	00 00 01	00-10	Rx. CHANNEL	1-16, OFF		Same as the Part Number
40 1x 03	00 00 01	00-01	Rx. PITCH BEND	OFF/ON	01	ON
40 1x 04	00 00 01	00-01	Rx. CH PRESSURE (CA)	OFF/ON	01	ON
40 1x 05	00 00 01	00-01	Rx. PROGRAM CHANGE	OFF/ON	01	ON
40 1x 06	00 00 01	00-01	Rx. CONTROL CHANGE	OFF/ON	01	ON
40 1x 07	00 00 01	00-01	Rx. POLY PRESSURE (PA)	OFF/ON	01	ON
40 1x 08	00 00 01	00-01	Rx. NOTE MESSAGE	OFF/ON	01	ON
40 1x 09	00 00 01	00-01	Rx. RPN	OFF/ON	01	ON
40 1x 0A	00 00 01	00-01	Rx. NRPN	OFF/ON	00 (01*)	OFF (ON*)

* Rx. NRPN is set to OFF by power-on or by receiving "Turn General MIDI System On," and it will be set ON when "GS RESET" is received.

40 1x 0B	00 00 01	00-01	Rx. MODULATION	OFF/ON	01	ON
40 1x 0C	00 00 01	00-01	Rx. VOLUME	OFF/ON	01	ON
40 1x 0D	00 00 01	00-01	Rx. PANPOT	OFF/ON	01	ON
40 1x 0E	00 00 01	00-01	Rx. EXPRESSION	OFF/ON	01	ON
40 1x 0F	00 00 01	00-01	Rx. HOLD1	OFF/ON	01	ON
40 1x 10	00 00 01	00-01	Rx. PORTAMENTO	OFF/ON	01	ON
40 1x 11	00 00 01	00-01	Rx. SOSTENUTO	OFF/ON	01	ON
40 1x 12	00 00 01	00-01	Rx. SOFT	OFF/ON	01	ON
40 1x 13	00 00 01	00-01	MONO/POLY MODE	Mono/Poly	01	Poly
40 1x 14	00 00 01	00-02	(= CC# 126 01 / CC# 127 00) ASSIGN MODE	0 = SINGLE 1 = LIMITED-MULTI 2 = FULL-MULTI	00 at x = 0 01 at x ≠ 0	SINGLE at x = 0 LIMITED-MULTI at x ≠ 0

* ASSIGN MODE is the parameter that determines how voice assignment will be handled when sounds overlap on identical note numbers in the same channel (i.e., repeatedly struck notes). This is initialized to a mode suitable for each Part, so for general purposes there is no need to change this.

40 1x 15	00 00 01	00-02	USE FOR RHYTHM PART	0 = OFF 1 = MAP1 2 = MAP2	00 at x ≠ 0 01 at x = 0	OFF at x ≠ 0 MAP1 at x = 0
----------	----------	-------	---------------------	---------------------------------	----------------------------	-------------------------------

* This parameter sets the Drum Map of the Part used as the Drum Part. AT-60R can simultaneously (in different Parts) use up to two Drum Maps (MAP1, MAP2). With the initial settings, Part10 (MIDI CH = 10, x = 0) is set to MAP1 (1), and other Parts are set to normal instrumental Parts (OFF (0)).

40 1x 16	00 00 01	28-58	PITCH KEY SHIFT	-24 - +24 [semitones]	40	0 [semitones]
40 1x 17	00 00 02	08-F8	PITCH OFFSET FINE	-12.0 - +12.0 [Hz]	08 00	0 [Hz]
40 1x 18#			Use nibblized data.			

* PITCH OFFSET FINE allows you to alter, by a specified frequency amount, the pitch at which notes will sound. This parameter differs from the conventional Fine Tuning (RPN #1) parameter in that the amount of frequency alteration (in Hertz) will be identical no matter which note is played. When a multiple number of Parts, each of which has been given a different setting for PITCH OFFSET FINE, are sounded by means of an identical note number, you can obtain a Celeste effect.

40 1x 19	00 00 01	00-7F	PART LEVEL (= CC# 7)	0-127	64	100
40 1x 1A	00 00 01	00-7F	VELOCITY SENSE DEPTH	0-127	40	64
40 1x 1B	00 00 01	00-7F	VELOCITY SENSE OFFSET	0-127	40	64
40 1x 1C	00 00 01	00-7F	PART PANPOT (= CC# 10, except RANDOM)	-64 (RANDOM), -63 (LEFT) - +63 (RIGHT)	40	0 (CENTER)
40 1x 1D	00 00 01	00-7F	KEY RANGE LOW	(C-1)-(G9)	00	C-1
40 1x 1E	00 00 01	00-7F	KEY RANGE HIGH	(C-1)-(G9)	7F	G 9
40 1x 1F	00 00 01	00-5F	CC1 CONTROLLER NUMBER	0-95	10	16
40 1x 20	00 00 01	00-5F	CC2 CONTROLLER NUMBER	0-95	11	17
40 1x 21	00 00 01	00-7F	CHORUS SEND LEVEL (= CC# 93)	0-127	00	0
40 1x 22	00 00 01	00-7F	REVERB SEND LEVEL (= CC# 91)	0-127	28	40
40 1x 23	00 00 01	00-01	Rx. BANK SELECT	OFF/ON	01 (00*)	ON (OFF*)

* Rx. BANK SELECT is set to ON by power-on or by receiving "GS RESET," and will be set OFF when "Turn General MIDI System On" is received.

40 1x 24 00 00 01 00-01 Rx.BANK SELECT LSB OFF/ON00OFF

* AT-60R can recognise Bank Select LSB (40H-43H) even if this message is OFF.

40 1x 25	00 00 01	00-01	TONE REMAIN	OFF/ON	01	ON
40 1x 28	00 00 03	00-7F	Bank Select LSB Range	LSB (from)	40	40H
40 1x 29#				LSB (to)	43	43H
40 1x 30	00 00 01	0E-72	TONE MODIFY 1	-50 - +50	40	0
			Vibrato rate (= NRP# 8)			
40 1x 31	00 00 01	0E-72	TONE MODIFY 2	-50 - +50	40	0
			Vibrato depth (= NRP# 9)			
40 1x 32	00 00 01	0E-72	TONE MODIFY 3	-50 - +50	40	0
			TVF cutoff frequency (= NRP# 32)			
40 1x 33	00 00 01	0E-72	TONE MODIFY 4	-50 - +50	40	0
			TVF resonance (= NRP# 33)			
40 1x 34	00 00 01	0E-72	TONE MODIFY 5	-50 - +50	40	0
			TVF&TVA Env.attack (= NRP# 99)			
40 1x 35	00 00 01	0E-72	TONE MODIFY 6	-50 - +50	40	0
			TVF&TVA Env.decay (= NRP# 100)			
40 1x 36	00 00 01	0E-72	TONE MODIFY 7	-50 - +50	40	0
			TVF&TVA Env.release (= NRP# 102)			
40 1x 37	00 00 01	0E-72	TONE MODIFY 8	-50 - +50	40	0
			Vibrato delay (= NRP# 10)			
40 1x 40	00 00 0C	00-7F	SCALE TUNING C	-64 - +63 [cent]	40	0 [cent]
40 1x 41#		00-7F	SCALE TUNING C#	-64 - +63 [cent]	40	0 [cent]
40 1x 42#		00-7F	SCALE TUNING D	-64 - +63 [cent]	40	0 [cent]
40 1x 43#		00-7F	SCALE TUNING D#	-64 - +63 [cent]	40	0 [cent]
40 1x 44#		00-7F	SCALE TUNING E	-64 - +63 [cent]	40	0 [cent]
40 1x 45#		00-7F	SCALE TUNING F	-64 - +63 [cent]	40	0 [cent]
40 1x 46#		00-7F	SCALE TUNING F#	-64 - +63 [cent]	40	0 [cent]
40 1x 47#		00-7F	SCALE TUNING G	-64 - +63 [cent]	40	0 [cent]
40 1x 48#		00-7F	SCALE TUNING G#	-64 - +63 [cent]	40	0 [cent]
40 1x 49#		00-7F	SCALE TUNING A	-64 - +63 [cent]	40	0 [cent]
40 1x 4A#		00-7F	SCALE TUNING A#	-64 - +63 [cent]	40	0 [cent]
40 1x 4B#		00-7F	SCALE TUNING B	-64 - +63 [cent]	40	0 [cent]

* SCALE TUNING is a function that allows fine adjustment to the pitch of each note in the octave. The pitch of each identically-named note in all octaves will change simultaneously. A setting of ± 0 cent (401 l) is equal temperament. Refer to section 4. Supplementary material, "The Scale Tune Feature" (p. 148).

40 2x 00	00 00 01	28-58	MOD PITCH CONTROL	-24 - +24 [semitone]	40	0 [semitones]
40 2x 01	00 00 01	00-7F	MOD TVF CUTOFF CONTROL	-9600 - +9600 [cent]	40	0 [cent]
40 2x 02	00 00 01	00-7F	MOD AMPLITUDE CONTROL	-100.0 - +100.0 [%]	40	0 [%]
40 2x 03	00 00 01	00-7F	MOD LFO1 RATE CONTROL	-10.0 - +10.0 [Hz]	40	0 [Hz]
40 2x 04	00 00 01	00-7F	MOD LFO1 PITCH DEPTH	0-600 [cent]	0A	47 [cent]
40 2x 05	00 00 01	00-7F	MOD LFO1 TVF DEPTH	0-2400 [cent]	00	0 [cent]
40 2x 06	00 00 01	00-7F	MOD LFO1 TVA DEPTH	0-100.0 [%]	00	0 [%]
40 2x 07	00 00 01	00-7F	MOD LFO2 RATE CONTROL	-10.0 - +10.0 [Hz]	40	0 [Hz]
40 2x 08	00 00 01	00-7F	MOD LFO2 PITCH DEPTH	0-600 [cent]	00	0 [cent]
40 2x 09	00 00 01	00-7F	MOD LFO2 TVF DEPTH	0-2400 [cent]	00	0 [cent]
40 2x 0A	00 00 01	00-7F	MOD LFO2 TVA DEPTH	0-100.0 [%]	00	0 [%]
40 2x 10	00 00 01	40-58	BEND PITCH CONTROL	0-24 [semitone]	42	2 [semitones]
40 2x 11	00 00 01	00-7F	BEND TVF CUTOFF CONTROL	-9600 - +9600 [cent]	40	0 [cent]
40 2x 12	00 00 01	00-7F	BEND AMPLITUDE CONTROL	-100.0 - +100.0 [%]	40	0 [%]
40 2x 13	00 00 01	00-7F	BEND LFO1 RATE CONTROL	-10.0 - +10.0 [Hz]	40	0 [Hz]
40 2x 14	00 00 01	00-7F	BEND LFO1 PITCH DEPTH	0-600 [cent]	00	0 [cent]
40 2x 15	00 00 01	00-7F	BEND LFO1 TVF DEPTH	0-2400 [cent]	00	0 [cent]
40 2x 16	00 00 01	00-7F	BEND LFO1 TVA DEPTH	0-100.0 [%]	00	0 [%]
40 2x 17	00 00 01	00-7F	BEND LFO2 RATE CONTROL	-10.0 - +10.0 [Hz]	40	0 [Hz]
40 2x 18	00 00 01	00-7F	BEND LFO2 PITCH DEPTH	0-600 [cent]	00	0 [cent]
40 2x 19	00 00 01	00-7F	BEND LFO2 TVF DEPTH	0-2400 [cent]	00	0 [cent]
40 2x 1A	00 00 01	00-7F	BEND LFO2 TVA DEPTH	0-100.0 [%]	00	0 [%]
40 2x 20	00 00 01	28-58	CAf PITCH CONTROL	-24 - +24 [semitone]	40	0 [semitones]
40 2x 21	00 00 01	00-7F	CAf TVF CUTOFF CONTROL	-9600 - +9600 [cent]	40	0 [cent]
40 2x 22	00 00 01	00-7F	CAf AMPLITUDE CONTROL	-100.0 - +100.0 [%]	40	0 [%]
40 2x 23	00 00 01	00-7F	CAf LFO1 RATE CONTROL	-10.0 - +10.0 [Hz]	40	0 [Hz]
40 2x 24	00 00 01	00-7F	CAf LFO1 PITCH DEPTH	0-600 [cent]	00	0 [cent]
40 2x 25	00 00 01	00-7F	CAf LFO1 TVF DEPTH	0-2400 [cent]	00	0 [cent]
40 2x 26	00 00 01	00-7F	CAf LFO1 TVA DEPTH	0-100.0 [%]	00	0 [%]
40 2x 27	00 00 01	00-7F	CAf LFO2 RATE CONTROL	-10.0 - +10.0 [Hz]	40	0 [Hz]
40 2x 28	00 00 01	00-7F	CAf LFO2 PITCH DEPTH	0-600 [cent]	00	0 [cent]
40 2x 29	00 00 01	00-7F	CAf LFO2 TVF DEPTH	0-2400 [cent]	00	0 [cent]
40 2x 2A	00 00 01	00-7F	CAf LFO2 TVA DEPTH	0-100.0 [%]	00	0 [%]
40 2x 30	00 00 01	28-58	PAf PITCH CONTROL	-24 - +24 [semitone]	40	0 [semitones]
40 2x 31	00 00 01	00-7F	PAf TVF CUTOFF CONTROL	-9600 - +9600 [cent]	40	0 [cent]
40 2x 32	00 00 01	00-7F	PAf AMPLITUDE CONTROL	-100.0 - +100.0 [%]	40	0 [%]
40 2x 33	00 00 01	00-7F	PAf LFO1 RATE CONTROL	-10.0 - +10.0 [Hz]	40	0 [Hz]
40 2x 34	00 00 01	00-7F	PAf LFO1 PITCH DEPTH	0-600 [cent]	00	0 [cent]

40 2x 35	00 00 01	00-7F	PA1 LFO1 TVF DEPTH	0-2400 [cent]	00	0 [cent]
40 2x 36	00 00 01	00-7F	PA1 LFO1 TVA DEPTH	0-100.0 [%]	00	0 [%]
40 2x 37	00 00 01	00-7F	PA1 LFO2 RATE CONTROL	-10.0 - +10.0 [Hz]	40	0 [Hz]
40 2x 38	00 00 01	00-7F	PA1 LFO2 PITCH DEPTH	0-600 [cent]	00	0 [cent]
40 2x 39	00 00 01	00-7F	PA1 LFO2 TVF DEPTH	0-2400 [cent]	00	0 [cent]
40 2x 3A	00 00 01	00-7F	PA1 LFO2 TVA DEPTH	0-100.0 [%]	00	0 [%]
40 2x 40	00 00 01	28-58	CC1 PITCH CONTROL	-24 - +24 [semitone]	40	0 [semitones]
40 2x 41	00 00 01	00-7F	CC1 TVF CUTOFF CONTROL	-9600 - +9600 [cent]	40	0 [cent]
40 2x 42	00 00 01	00-7F	CC1 AMPLITUDE CONTROL	-100.0 - +100.0 [%]	40	0 [%]
40 2x 43	00 00 01	00-7F	CC1 LFO1 RATE CONTROL	-10.0 - +10.0 [Hz]	40	0 [Hz]
40 2x 44	00 00 01	00-7F	CC1 LFO1 PITCH DEPTH	0-600 [cent]	00	0 [cent]
40 2x 45	00 00 01	00-7F	CC1 LFO1 TVF DEPTH	0-2400 [cent]	00	0 [cent]
40 2x 46	00 00 01	00-7F	CC1 LFO1 TVA DEPTH	0-100.0 [%]	00	0 [%]
40 2x 47	00 00 01	00-7F	CC1 LFO2 RATE CONTROL	-10.0 - +10.0 [Hz]	40	0 [Hz]
40 2x 48	00 00 01	00-7F	CC1 LFO2 PITCH DEPTH	0-600 [cent]	00	0 [cent]
40 2x 49	00 00 01	00-7F	CC1 LFO2 TVF DEPTH	0-2400 [cent]	00	0 [cent]
40 2x 4A	00 00 01	00-7F	CC1 LFO2 TVA DEPTH	0-100.0 [%]	00	0 [%]
40 2x 50	00 00 01	28-58	CC2 PITCH CONTROL	-24 - +24 [semitone]	40	0 [semitones]
40 2x 51	00 00 01	00-7F	CC2 TVF CUTOFF CONTROL	-9600 - +9600 [cent]	40	0 [cent]
40 2x 52	00 00 01	00-7F	CC2 AMPLITUDE CONTROL	-100.0 - +100.0 [%]	40	0 [%]
40 2x 53	00 00 01	00-7F	CC2 LFO1 RATE CONTROL	-10.0 - +10.0 [Hz]	40	0 [Hz]
40 2x 54	00 00 01	00-7F	CC2 LFO1 PITCH DEPTH	0-600 [cent]	00	0 [cent]
40 2x 55	00 00 01	00-7F	CC2 LFO1 TVF DEPTH	0-2400 [cent]	00	0 [cent]
40 2x 56	00 00 01	00-7F	CC2 LFO1 TVA DEPTH	0-100.0 [%]	00	0 [%]
40 2x 57	00 00 01	00-7F	CC2 LFO2 RATE CONTROL	-10.0 - +10.0 [Hz]	40	0 [Hz]
40 2x 58	00 00 01	00-7F	CC2 LFO2 PITCH DEPTH	0-600 [cent]	00	0 [cent]
40 2x 59	00 00 01	00-7F	CC2 LFO2 TVF DEPTH	0-2400 [cent]	00	0 [cent]
40 2x 5A	00 00 01	00-7F	CC2 LFO2 TVA DEPTH	0-100.0 [%]	00	0 [%]

● Drum Setup Parameters (GS Part: Model ID = 42H)

- * m: Map number (0 = MAP1, 1 = MAP2)
- * rr: drum part note number (00H-7FH)

Address (H)	Size (H)	Data (H)	Parameter	Description
41 m1 rr	00 00 01	00-7F	PLAY NOTE NUMBER	Pitch coarse
41 m2 rr	00 00 01	00-7F	LEVEL (= NRP# 26)	TVA level
41 m3 rr	00 00 01	00-7F	ASSIGN GROUP NUMBER	Non, 1-127
41 m4 rr	00 00 01	00-7F	PANPOT (= NRP# 28, except RANDOM)	-64 (RANDOM), -63 (LEFT) - +63 (RIGHT)
41 m5 rr	00 00 01	00-7F	REVERB SEND LEVEL (= NRP# 29)	0.0-1.0 Multiplicand of the part reverb depth
41 m6 rr	00 00 01	00-7F	CHORUS SEND LEVEL (= NRP# 30)	0.0-1.0 Multiplicand of the part chorus depth
41 m7 rr	00 00 01	00-01	Rx. NOTE OFF	OFF/ON
41 m8 rr	00 00 01	00-01	Rx. NOTE ON	OFF/ON

- * When the Drum Set is changed, DRUM SETUP PARAMETER values will all be initialized.

4. Supplementary material

●Decimal and Hexadecimal table

In MIDI documentation, data values and addresses/sizes of exclusive messages etc. are expressed as hexadecimal values for each 7 bits.

The following table shows how these correspond to decimal numbers.

Dec.	Hex.	Dec.	Hex.	Dec.	Hex.	Dec.	Hex.
0	00H	32	20H	64	40H	96	60H
1	01H	33	21H	65	41H	97	61H
2	02H	34	22H	66	42H	98	62H
3	03H	35	23H	67	43H	99	63H
4	04H	36	24H	68	44H	100	64H
5	05H	37	25H	69	45H	101	65H
6	06H	38	26H	70	46H	102	66H
7	07H	39	27H	71	47H	103	67H
8	08H	40	28H	72	48H	104	68H
9	09H	41	29H	73	49H	105	69H
10	0AH	42	2AH	74	4AH	106	6AH
11	0BH	43	2BH	75	4BH	107	6BH
12	0CH	44	2CH	76	4CH	108	6CH
13	0DH	45	2DH	77	4DH	109	6DH
14	0EH	46	2EH	78	4EH	110	6EH
15	0FH	47	2FH	79	4FH	111	6FH
16	10H	48	30H	80	50H	112	70H
17	11H	49	31H	81	51H	113	71H
18	12H	50	32H	82	52H	114	72H
19	13H	51	33H	83	53H	115	73H
20	14H	52	34H	84	54H	116	74H
21	15H	53	35H	85	55H	117	75H
22	16H	54	36H	86	56H	118	76H
23	17H	55	37H	87	57H	119	77H
24	18H	56	38H	88	58H	120	78H
25	19H	57	39H	89	59H	121	79H
26	1AH	58	3AH	90	5AH	122	7AH
27	1BH	59	3BH	91	5BH	123	7BH
28	1CH	60	3CH	92	5CH	124	7CH
29	1DH	61	3DH	93	5DH	125	7DH
30	1EH	62	3EH	94	5EH	126	7EH
31	1FH	63	3FH	95	5FH	127	7FH

- Decimal values such as MIDI channel, bank select, and program change are listed as one (1) greater than the values given in the above table.
- A 7-bit byte can express data in the range of 128 steps. For data where greater precision is required, we must use two or more bytes. For example, two hexadecimal numbers aa bbH expressing two 7-bit bytes would indicate a value of $aa \times 128 + bb$.
- In the case of values which have a \pm sign, 00H = -64, 40H = ± 0 , and 7FH = +63, so that the decimal expression would be 64 less than the value given in the above chart. In the case of two types, 00 00H = -8192, 40 00H = ± 0 , and 7F 7FH = +8191. For example if aa bbH were expressed as decimal, this would be $aa \text{ bbH} - 40 \text{ 00H} = aa \times 128 + bb - 64 \times 128$.
- Data marked "nibbled" is expressed in hexadecimal in 4-bit units. A value expressed as a 2-byte nibble 0a 0bH has the value of $a \times 16 + b$.

<Example 1> What is the decimal expression of 5AH ?
From the preceding table, 5AH = 90

<Example 2> What is the decimal expression of the value 12 34H given as hexadecimal for each 7 bits?
From the preceding table, since 12H = 18 and 34H = 52
 $18 \times 128 + 52 = 2356$

<Example 3> What is the decimal expression of the nibbled value 0A 03 09 0D ?
From the preceding table, since 0AH = 10, 03H = 3, 09H = 9, 0DH = 13
 $(10 \times 16 + 3) \times 16 + 9 \times 16 + 13 = 41885$

<Example 4> What is the nibbled expression of the decimal value 1258?

$$\begin{array}{r} 16 \overline{) 1258} \\ 16 \overline{) 78} \quad \dots 10 \\ 16 \overline{) 4} \quad \dots 14 \\ \quad \quad \quad 0 \quad \dots 4 \end{array}$$

Since from the preceding table, 0 = 00H, 4 = 04H, 14 = 0EH, 10 = 0AH, the answer is 00 04 0E 0AH.

●Examples of actual MIDI messages

<Example 1> 92 3E 5F

9n is the Note-on status, and n is the MIDI channel number. Since 2H = 2, 3EH = 62, and 5FH = 95, this is a Note-on message with MIDI CH = 3, note number 62 (note name is D4), and velocity 95.

<Example 2> CE 49

CnH is the Program Change status, and n is the MIDI channel number. Since EH = 14 and 49H = 73, this is a Program Change message with MIDI CH = 15, program number 74 (Flute in GS).

<Example 3> EA 00 28

EnH is the Pitch Bend Change status, and n is the MIDI channel number. The 2nd byte (00H = 0) is the LSB and the 3rd byte (28H = 40) is the MSB, but Pitch Bend Value is a signed number in which $40 \text{ 00H} = 64 \times 128 + 0 = 8192$ is 0, so this Pitch Bend Value is $28 \text{ 00H} - 40 \text{ 00H} = 40 \times 128 + 0 - (64 \times 128 + 0) = 5120 - 8192 = -3072$

If the Pitch Bend Sensitivity is set to 2 semitones, -8192 (00 00H) will cause the pitch to change -200 cents, so in this case $-200 \times (-3072) / (-8192) = -75$ cents of Pitch Bend is being applied to MIDI channel 11.

<Example 4> B3 64 00 65 00 06 0C 26 00 64 7F 65 7F

BnH is the Control Change status, and n is the MIDI channel number. For Control Changes, the 2nd byte is the control number, and the 3rd byte is the value. In a case in which two or more messages consecutive messages have the same status, MIDI has a provision called "running status" which allows the status byte of the second and following messages to be omitted. Thus, the above messages have the following meaning.

B3 64 00	MIDI ch.4, lower byte of RPN parameter number: 00H
(B3) 65 00	(MIDI ch.4) upper byte of RPN parameter number: 00H
(B3) 06 0C	(MIDI ch.4) upper byte of parameter value: 0CH
(B3) 26 00	(MIDI ch.4) lower byte of parameter value: 00H
(B3) 64 7F	(MIDI ch.4) lower byte of RPN parameter number: 7FH
(B3) 65 7F	(MIDI ch.4) upper byte of RPN parameter number: 7FH

In other words, the above messages specify a value of 0C 00H for RPN parameter number 00 00H on MIDI channel 4, and then set the RPN parameter number to 7F 7FH.

RPN parameter number 00 00H is Pitch Bend Sensitivity, and the MSB of the value indicates semitone units, so a value of 0CH = 12 sets the maximum pitch bend range to ± 12 semitones (1 octave). (On GS sound sources the LSB of Pitch Bend Sensitivity is ignored, but the LSB should be transmitted anyway (with a value of 0) so that operation will be correct on any device.)

Once the parameter number has been specified for RPN or NRPN, all Data Entry messages transmitted on that same channel will be valid, so after the desired value has been transmitted, it is a good idea to set the parameter number to 7F 7FH to prevent accidents. This is the reason for the (B3) 64 7F (B3) 65 7F at the end.

It is not desirable for performance data (such as Standard MIDI File data) to contain many events with running status as given in <Example 4>. This is because if playback is halted during the song and then rewound or fast-forwarded, the sequencer may not be able to transmit the correct status, and the sound source will then misinterpret the data. Take care to give each event its own status.

It is also necessary that the RPN or NRPN parameter number setting and the value setting be done in the proper order. On some sequencers, events occurring in the same (or consecutive) clock may be transmitted in an order different than the order in which they were received. For this reason it is a good idea to slightly skew the time of each event (about 1 tick for TPQN = 96, and about 5 ticks for TPQN = 480).

* TPQN: Ticks Per Quarter Note

● Example of an Exclusive message and calculating a Checksum

Roland Exclusive messages are transmitted with a checksum at the end (before F7) to make sure that the message was correctly received. The value of the checksum is determined by the address and data (or size) of the transmitted exclusive message.

How to calculate the checksum (hexadecimal numbers are indicated by 'H')

The checksum is a value derived by adding the address, size and checksum itself and inverting the lower 7 bits.

Here's an example of how the checksum is calculated. We will assume that in the exclusive message we are transmitting, the address is aa bb cH and the data or size is dd ee ffH.

aa + bb + cc + dd + ee + ff = sum
sum / 128 = quotient ... remainder
128 - remainder = checksum

<Example> Setting REVERB MACRO to ROOM 3

According to the "Parameter Address Map," the REVERB MACRO Address is 40 01 30H, and ROOM 3 is a value of 02H. Thus,

F0	41	10	42	12	40	01	30	02	??	F7
(1)	(2)	(3)	(4)	(5)	Address		data	Checksum	(6)	

(1) Exclusive Status, (2) ID (Roland), (3) Device ID (17),
(4) Model ID (GS), (5) Command ID (DT1), (6) End of Exclusive

Next we calculate the checksum.

40H + 01H + 30H + 02H = 64 + 1 + 48 + 2 = 115 (sum)
115 (sum) / 128 = 0 (quotient) ... 115 (remainder)
checksum = 128 - 115 (remainder) = 13 = 0DH

This means that F0 41 10 42 12 40 01 30 02 0D F7 is the message we transmit.

● About tuning

In MIDI, individual Parts are tuned by sending RPN #1 (Master Fine Tuning) to the appropriate MIDI channel.

In MIDI, an entire device is tuned by either sending RPN #1 to all MIDI channels being used, or by sending a System Exclusive MASTER TUNE (address 40 00 00H).

RPN #1 allows tuning to be specified in steps of approximately 0.012 cents (to be precise, 100/8192 cent), and System Exclusive MASTER TUNE allows tuning in steps of 0.1 cent. One cent is 1/100th of a semitone.

The values of RPN #1 (Master Fine Tuning) and System Exclusive MASTER TUNE are added together to determine the actual pitch sounded by each Part.

Frequently used tuning values are given in the following table for your reference. Values are in hexadecimal (decimal in parentheses).

Hz in A4	cent	RPN #1	Sys.Ex. 40 00 00
445.0	+19.56	4C 43 (+1603)	00 04 0C 04 (+196)
444.0	+15.67	4A 03 (+1283)	00 04 09 0D (+157)
443.0	+11.76	47 44 (+ 964)	00 04 07 06 (+118)
442.0	+ 7.85	45 03 (+ 643)	00 04 04 0F (+ 79)
441.0	+ 3.93	42 42 (+ 322)	00 04 02 07 (+ 39)
440.0	0.00	40 00 (0)	00 04 00 00 (0)
439.0	- 3.94	3D 3D (- 323)	00 03 0D 09 (- 39)
438.0	- 7.89	3A 7A (- 646)	00 03 0B 01 (- 79)

<Example> Set the tuning of MIDI channel 3 to A4 = 442.0 Hz

Send RPN#1 to MIDI channel 3. From the above table, the value is 45 03H.

B2	64 00	MIDI ch.3, lower byte of RPN parameter number: 00H
(B2)	65 01	(MIDI ch.3) upper byte of RPN parameter number: 01H
(B2)	06 45	(MIDI ch.3) upper byte of parameter value: 45H
(B2)	26 03	(MIDI ch.3) lower byte of parameter value: 03H
(B2)	64 7F	(MIDI ch.3) lower byte of RPN parameter number: 7FH
(B2)	65 7F	(MIDI ch.3) upper byte of RPN parameter number: 7FH

● The Scale Tune Feature (address: 40 1x 40)

The scale Tune feature allows you to finely adjust the individual pitch of the notes from C through B. Though the settings are made while working with one octave, the fine adjustments will affect all octaves. By making the appropriate Scale Tune settings, you can obtain a complete variety of tuning methods other than equal temperament. As examples, three possible types of scale setting are explained below.

○ Equal Temperament

This method of tuning divides the octave into 12 equal parts. It is currently the most widely used form of tuning, especially in occidental music. On AT-60R, the default settings for the Scale Tune feature produce equal temperament.

○ Just Temperament (Keytone C)

The three main chords resound much more beautifully than with equal temperament, but this benefit can only be obtained in one key. If transposed, the chords tend to become ambiguous. The example given involves settings for a key in which C is the keytone.

○ Arabian Scale

By altering the setting for Scale Tune, you can obtain a variety of other tunings suited for ethnic music. For example, the settings introduced below will set the unit to use the Arabian Scale.

Example Settings

Note name	Equal Temperament	Just Temperament (Keytone C)	Arabian Scale
C	0	0	-6
C#	0	-8	+45
D	0	+4	-2
D#	0	+16	-12
E	0	-14	-51
F	0	-2	-8
F#	0	-10	+43
G	0	+2	-4
G#	0	+14	+47
A	0	-16	0
A#	0	+14	-10
B	0	-12	-49

The values in the table are given in cents. Refer to the explanation of Scale Tuning (p. 145) to convert these values to hexadecimal, and transmit them as exclusive data.

For example, to set the tune (C-B) of the Part1 Arabian Scale, send the data as follows:

F0 41 10 42 12 40 11 40 3A 6D 3E 34 0D 38 6B 3C 6F 40 36 0F 50 F7

●AT-60R Keyboard Part Tone List

CC0 / CC32 / PC	Tone Name	Number of Voice	No.
00h / 00h / 00h	Full Organ1	1	A11
00h / 00h / 02h	Full Organ2	1	A12
00h / 00h / 04h	Full Organ3	1	A13
00h / 00h / 01h	Full Organ4	1	A14
00h / 00h / 03h	Full Organ5	1	A15
00h / 00h / 05h	Full Organ6	1	A16
00h / 00h / 20h	Full Organ7	1	A17
00h / 00h / 06h	Jazz Organ1	2	B11
00h / 00h / 08h	Jazz Organ2	2	B12
00h / 00h / 0Ah	Jazz Organ3	2	B13
00h / 00h / 07h	Jazz Organ4	2	B14
00h / 00h / 09h	Jazz Organ5	2	B15
00h / 00h / 0Bh	Jazz Organ6	2	B16
00h / 00h / 0Ch	Rock Organ1	3	B21
00h / 00h / 0Dh	Rock Organ2	2	B22
00h / 00h / 0Eh	Lower Organ1	1	C11
00h / 00h / 10h	Lower Organ2	1	C12
00h / 00h / 12h	Lower Organ3	1	C13
00h / 00h / 0Fh	Lower Organ4	1	C14
00h / 00h / 11h	Lower Organ5	1	C15
00h / 00h / 13h	Lower Organ6	1	C16
00h / 00h / 14h	Pipe Organ1	1	D11
00h / 00h / 16h	Pipe Organ2	2	D12
00h / 00h / 18h	Pipe Organ3	2	D13
00h / 00h / 15h	Pipe Organ4	1	D14
00h / 00h / 17h	Pipe Organ5	2	D15
00h / 00h / 19h	Pipe Organ6	4	D16
00h / 00h / 21h	Pipe Organ7	2	D17
02h / 00h / 14h	Diapason 8'	1	D21
01h / 00h / 14h	FluteCeleste	2	D22
01h / 00h / 21h	Gemshorn 8'	1	D23
02h / 00h / 21h	Trompet 8'	1	D24
03h / 00h / 21h	Hautbois 8'	1	D25
04h / 00h / 21h	Viola 8'	1	D26
05h / 00h / 21h	ViolaCeleste	2	D27
06h / 00h / 21h	Bombardel6'	1	D28
01h / 00h / 22h	T.String 8'	2	D31
02h / 00h / 22h	VoxHumana 8'	2	D32
03h / 00h / 22h	T.Tuba 8'	2	D33
04h / 00h / 22h	T.Trumpet 8'	2	D34
05h / 00h / 22h	T.Sax 8'	2	D35
06h / 00h / 22h	T.Oboe 8'	2	D36
07h / 00h / 22h	T.Krumet 8'	1	D37
08h / 00h / 22h	Eng.Horn 8'	2	D38
00h / 00h / 1Ah	Theater Or.1	2	E11
00h / 00h / 1Ch	Theater Or.2	2	E12
00h / 00h / 1Eh	Theater Or.3	2	E13
00h / 00h / 1Bh	Theater Or.4	2	E14
00h / 00h / 1Dh	Theater Or.5	2	E15
00h / 00h / 1Fh	Theater Or.6	2	E16
00h / 00h / 22h	Theater Or.7	3	E17
00h / 00h / 23h	Synth. Org.1	2	F11
00h / 00h / 24h	Synth. Org.2	3	F12
01h / 00h / 23h	Synth. Org.3	2	F13
01h / 00h / 24h	Synth. Org.4	2	F14
00h / 00h / 25h	Pop. Organ1	1	F21
00h / 00h / 26h	Pop. Organ2	1	F22

CC0 / CC32 / PC	Tone Name	Number of Voice	No.
00h / 00h / 27h	Pop. Organ3	1	F23
00h / 00h / 28h	Strings1	4	G11
00h / 00h / 29h	Strings2	2	G12
01h / 00h / 28h	Strings3	2	G13
01h / 00h / 29h	Strings4	1	G14
02h / 00h / 28h	Strings5	2	G15
03h / 00h / 28h	Strings6	2	G16
04h / 00h / 28h	Strings7	2	G17
05h / 00h / 28h	Strings8	2	G18
00h / 00h / 2Ah	Slow Str.1	2	H11
00h / 00h / 2Bh	Slow Str.2	2	H12
01h / 00h / 2Ah	Slow Str.3	2	H13
00h / 00h / 2Ch	Synth. Str.1	2	H21
00h / 00h / 2Dh	Synth. Str.2	3	H22
00h / 00h / 35h	Synth. Str.3	2	H23
00h / 00h / 2Eh	Synth. Pad1	3	H31
00h / 00h / 2Fh	Synth. Pad2	4	H32
00h / 00h / 5Ch	Violin	2	I11
00h / 00h / 66h	Viola	1	I12
00h / 00h / 5Dh	Cello	2	I13
00h / 00h / 37h	Pizzicato	2	I14
01h / 00h / 31h	Jazz Scat	2	J11
00h / 00h / 31h	Pop Voice	2	J12
02h / 00h / 31h	Jazz Doo	2	J13
03h / 00h / 31h	Jazz Doot	2	J14
04h / 00h / 31h	Jazz Dat	2	J15
05h / 00h / 31h	Jazz Bap	2	J16
06h / 00h / 31h	JazzDowfall	2	J17
00h / 00h / 30h	Choir	2	J21
01h / 00h / 30h	Gregorian	2	J22
02h / 00h / 30h	Classical	2	J23
03h / 00h / 30h	Boys Choir	2	J24
00h / 00h / 32h	Synth. Choir	2	J31
00h / 00h / 33h	Synth. Voice	3	J32
00h / 00h / 34h	Spare Voice	2	J33
01h / 00h / 34h	Vocal Menu	2	J41
02h / 00h / 38h	Grand Piano	2-3	K11
00h / 00h / 38h	Piano1	1	K12
00h / 00h / 4Fh	Piano2	1	K13
01h / 00h / 38h	Piano3	1	K14
00h / 00h / 39h	Honky-tonk	2	K21
01h / 00h / 39h	Honky-tonk2	2-4	K22
00h / 00h / 3Ah	E.Piano1	2	K31
00h / 00h / 3Bh	E.Piano2	2	K32
01h / 00h / 3Ah	E.Piano3	1	K33
01h / 00h / 3Bh	E.Piano4	2	K34
00h / 00h / 42h	Harpsichord	1	K41
00h / 00h / 50h	Clavi	1	K42
00h / 00h / 48h	Accordion	1	L11
00h / 00h / 55h	Bandoneon	1	L12
00h / 00h / 49h	Harmonica	1	L21
00h / 00h / 3Ch	Nylon-str.Gt	1	M11
01h / 00h / 3Ch	Nylon Gt 2	1	M12
00h / 00h / 3Dh	Steel-str.Gt	1	M21
00h / 00h / 3Eh	Jazz Guitar	1	M31
01h / 00h / 3Fh	Clean Guitar	2	M32
02h / 00h / 3Eh	JC E.Guitar	2	M33
00h / 00h / 3Fh	Overdrive Gt	1	M41
00h / 00h / 56h	Hawaiian Gt.	1	N11

CC0 / CC32 / PC	Tone Name	Number of Voice	No.
00h / 00h / 47h	Banjo	1	N12
00h / 00h / 46h	Mandolin	1	N13
01h / 00h / 43h	Koto	1	N14
02h / 00h / 43h	Taisho Koto	1	N15
03h / 00h / 43h	Shamisen	2	N16
00h / 00h / 43h	Harp	1	N21
00h / 00h / 5Ah	Sitar	1	N31
00h / 00h / 57h	Organ Harp	1	N41
00h / 00h / 44h	Vibraphone	1	O11
00h / 00h / 52h	Glockenspiel	1	O12
00h / 00h / 51h	Celesta	1	O13
00h / 00h / 45h	Marimba	1	O21
00h / 00h / 53h	Xylophone	1	O22
00h / 00h / 54h	Tubular-bell	1	O31
00h / 00h / 5Bh	Steel Drums	1	O41
01h / 00h / 5Ah	Kalimba	1	O42
01h / 00h / 54h	Organ Bell	1	O51
03h / 00h / 54h	Vibra Bells	2	O52
00h / 00h / 40h	Trp. Section	3	P11
00h / 00h / 58h	Fr.Horn Sect	2	P21
01h / 00h / 58h	Fr.HornSect2	2	P22
00h / 00h / 41h	Sax.Section	3	P31
01h / 00h / 41h	Sax.Section2	3	P32
00h / 00h / 59h	Synth. Brass	2	P41
00h / 00h / 5Eh	Trumpet	2	Q11
01h / 00h / 5Eh	Trumpet2	2	Q12
00h / 00h / 5Fh	Mute Trumpet	1	Q21
01h / 00h / 5Fh	Mute Trumpet2	1	Q22
00h / 00h / 68h	Trombone	1	Q31
01h / 00h / 68h	Trombone2	1	Q32
00h / 00h / 67h	Flugel Horn	1	Q41
01h / 00h / 67h	F.Horn Solo1	2	Q42
00h / 00h / 69h	Soprano Sax	1	Q51
01h / 00h / 69h	Soprano Sax2	1	Q52
00h / 00h / 60h	Alto Sax	2	Q61
01h / 00h / 60h	Alto Sax2	2	Q62
00h / 00h / 61h	Tenor Sax	2	Q71
01h / 00h / 61h	Tenor Sax2	2	Q72
00h / 00h / 62h	Flute	1	R11
01h / 00h / 62h	Flute2	1	R12
02h / 00h / 62h	Flute3	1	R13
00h / 00h / 36h	Synth. Flute	2	R21
00h / 00h / 63h	Pan Flute	1	R22
00h / 00h / 64h	Oboe	2	R31
00h / 00h / 6Ah	Bassoon	1	R32
00h / 00h / 65h	Clarinet	1	R41
01h / 00h / 65h	Clarinet2	2	R42
02h / 00h / 65h	Clarinet3	1	R43
03h / 00h / 65h	Clarinet4	2	R44
04h / 00h / 65h	Bs Clarinet	1	R45
00h / 00h / 6Bh	Shakuhachi	1	R51
00h / 00h / 6Ch	Human Whistle	1	R52
00h / 00h / 6Dh	Synth. Lead1	1	S11
00h / 00h / 6Eh	Synth. Lead2	2	S12
00h / 00h / 6Fh	Synth. Lead3	1	S13
00h / 00h / 70h	Synth. Lead4	2	S14
00h / 00h / 71h	Synth. Lead5	2	S15
00h / 00h / 72h	Organ Bass1	2	T11
00h / 00h / 73h	Organ Bass2	2	T12

CC0 / CC32 / PC	Tone Name	Number of Voice	No.
00h / 00h / 74h	Pipe Org. Bs	3	T21
01h / 00h / 74h	Theater Bass	2	T22
02h / 00h / 74h	Bombarde	4	T23
00h / 00h / 75h	String Bass	2	T31
00h / 00h / 7Dh	Bass-Cymbal	4	T32
01h / 00h / 75h	String Bass2	1	T33
00h / 00h / 78h	Contrabass1	2	T41
00h / 00h / 79h	Contrabass2	2	T42
00h / 00h / 76h	E. Bass1	2	T51
00h / 00h / 77h	E. Bass2	2	T52
01h / 00h / 76h	E. Bass3	1	T53
01h / 00h / 77h	E. Bass4	1	T54
00h / 00h / 7Ah	Tuba	2	T61
01h / 00h / 7Ah	Tuba2	3	T62
00h / 00h / 7Bh	Synth. Bass1	3	T71
00h / 00h / 7Ch	Synth. Bass2	2	T72
01h / 00h / 7Ch	Voice Thum	1	T81
00h / 00h / 4Ah	Org. Attack1	1	U11
00h / 00h / 4Bh	Org. Attack2	1	U12
00h / 00h / 4Ch	Org. Attack3	1	U13
00h / 00h / 4Dh	Org. Attack4	1	U14
00h / 00h / 4Eh	Org. Click	1	U15
01h / 00h / 7Eh	Timpani	1	V11
02h / 00h / 7Eh	Timpani2	2	V12
01h / 00h / 7Dh	Ride Cymbal	1	V21
02h / 00h / 7Dh	Crash Cymbal	1	V22
03h / 00h / 7Dh	Tambourine	1	V23
04h / 00h / 7Dh	Woodblock	1	V24
05h / 00h / 7Dh	Jingle Bell	1	V25
06h / 00h / 7Dh	Snare Drum	1	V26
07h / 00h / 7Dh	Bass Drum	1	V27
00h / 00h / 7Eh	Perc. Set1	1-3	V31
00h / 00h / 7Fh	Perc. Set2	1-4	V32
01h / 00h / 7Fh	Perc. Set3	1-4	V33
02h / 00h / 7Fh	Orch.HitMenu	1-2	V34

●Voice List (GS Part)

CC0 / CC32 / PC	Voice Name	Voice Number
00h / 00h / 00h	Piano 1	1
08h / 00h / 00h	Piano 1w	2
10h / 00h / 00h	Piano 1d	1
00h / 00h / 01h	Piano 2	1
08h / 00h / 01h	Piano 2w	2
00h / 00h / 02h	Piano 3	1
08h / 00h / 02h	Piano 3w	2
00h / 00h / 03h	Honky-tonk	2
08h / 00h / 03h	Honky-tonk 2	2
00h / 00h / 04h	GS E.Piano1	1
08h / 00h / 04h	Detuned EP 1	2
10h / 00h / 04h	E.Piano 1v	2
18h / 00h / 04h	60's E.Piano	1
00h / 00h / 05h	GS E.Piano2	1
08h / 00h / 05h	Detuned EP 2	2
10h / 00h / 05h	E.Piano 2v	2
00h / 00h / 06h	Harpsichord	1
08h / 00h / 06h	Coupled Hps.	2
10h / 00h / 06h	Harpsi.w	2
18h / 00h / 06h	Harpsi.o	2

CC0 / CC32 / PC	Voice Name	Voice Number
00h / 00h / 07h	Clav.	1
00h / 00h / 08h	Celesta	1
00h / 00h / 09h	Glockenspiel	1
00h / 00h / 0Ah	GS Music Box	1
00h / 00h / 0Bh	GS Vibe	1
08h / 00h / 0Bh	Vibe.w	2
00h / 00h / 0Ch	GS Marimba	1
08h / 00h / 0Ch	Marimba	1
00h / 00h / 0Dh	Xylophone	1
00h / 00h / 0Eh	Tubular-bell	1
08h / 00h / 0Eh	Church Bell	1
09h / 00h / 0Eh	Carillon	1
00h / 00h / 0Fh	GS Santur	1
00h / 00h / 10h	Organ 1	1
01h / 00h / 10h	Full Organ 1	1
08h / 00h / 10h	Detuned Or.1	2
09h / 00h / 10h	Full Organ 2	1
10h / 00h / 10h	Pop Organ 1	1
11h / 00h / 10h	Pop Organ 2	1
12h / 00h / 10h	Pop Organ	1
20h / 00h / 10h	Full Organ 4	1
21h / 00h / 10h	Full Organ 3	1
00h / 00h / 11h	Organ 2	1
01h / 00h / 11h	Jazz Organ 3	2
08h / 00h / 11h	Detuned Or.2	2
20h / 00h / 11h	Jazz Organ 1	2
00h / 00h / 12h	Rock Organ 2	2
00h / 00h / 13h	Church Org.1	1
08h / 00h / 13h	Church Org.2	2
10h / 00h / 13h	Church Org.3	2
00h / 00h / 14h	Reed Organ	1
00h / 00h / 15h	Accordion Fr	2
08h / 00h / 15h	Accordion It	2
00h / 00h / 16h	GS Harmonica	1
01h / 00h / 16h	Harmonica	1
00h / 00h / 17h	Bandoneon	2
00h / 00h / 18h	GS Nylon Gt.	1
08h / 00h / 18h	Ukulele	1
10h / 00h / 18h	Nylon Gt.o	2
20h / 00h / 18h	Nylon Guitar	1
00h / 00h / 19h	Steel-str.Gt	1
08h / 00h / 19h	12-str.Gt	2
09h / 00h / 19h	Nylon+Steel	2
10h / 00h / 19h	GS Mandolin	1
20h / 00h / 19h	Steel Gt.2	1
00h / 00h / 1Ah	Jazz Guitar	1
08h / 00h / 1Ah	GS Hawaiian	1
00h / 00h / 1Bh	Clean Gt.	1
08h / 00h / 1Bh	Chorus Gt.	2
00h / 00h / 1Ch	Muted Gt.	1
08h / 00h / 1Ch	Funk Gt.	1
10h / 00h / 1Ch	Funk Gt.2	2
00h / 00h / 1Dh	Overdrive Gt	1
00h / 00h / 1Eh	GS Dist.Gt	1
08h / 00h / 1Eh	Feedback Gt.	2
00h / 00h / 1Fh	Gt.Harmonics	1
08h / 00h / 1Fh	Gt.Feedback	1
10h / 00h / 1Fh	Gt.Harmonics	1
00h / 00h / 20h	GS Ac.Bass	1

CC0 / CC32 / PC	Voice Name	Voice Number
00h / 00h / 21h	GS Fing Bass	1
00h / 00h / 22h	GS Picked Bs	1
00h / 00h / 23h	Fretless Bs.	1
00h / 00h / 24h	Slap Bass 1	1
00h / 00h / 25h	Slap Bass 2	1
00h / 00h / 26h	Synth Bass 1	1
01h / 00h / 26h	SynthBass101	1
08h / 00h / 26h	Synth Bass 3	1
00h / 00h / 27h	Synth Bass 2	2
08h / 00h / 27h	Synth Bass 4	2
10h / 00h / 27h	Rubber Bass	2
00h / 00h / 28h	GS Violin	1
08h / 00h / 28h	Slow Violin	1
00h / 00h / 29h	Viola	1
00h / 00h / 2Ah	GS Cello	1
00h / 00h / 2Bh	Contrabass	1
00h / 00h / 2Ch	Tremolo Str	1
00h / 00h / 2Dh	Pizzicato5Str	1
00h / 00h / 2Eh	GS Harp	1
00h / 00h / 2Fh	Timpani	1
00h / 00h / 30h	GS Strings	1
08h / 00h / 30h	Orchestra	2
00h / 00h / 31h	GS Sl.Str	1
00h / 00h / 32h	Syn.Strings1	1
08h / 00h / 32h	Syn.Strings3	2
00h / 00h / 33h	Syn.Strings2	2
00h / 00h / 34h	Choir Aahs	1
20h / 00h / 34h	Choir	1
00h / 00h / 35h	Pop Voice	1
00h / 00h / 36h	SynVox	1
00h / 00h / 37h	OrchestraHit	2
00h / 00h / 38h	GS Trumpet	1
01h / 00h / 38h	Trumpet	1
00h / 00h / 39h	GS Trombone	1
01h / 00h / 39h	Trombone 2	2
00h / 00h / 3Ah	Tuba	1
00h / 00h / 3Bh	Muted Trumpet	1
00h / 00h / 3Ch	French Horn	2
01h / 00h / 3Ch	Fr.Horn 2	2
00h / 00h / 3Dh	Brass 1	1
08h / 00h / 3Dh	Brass 2	2
00h / 00h / 3Eh	Synth Brass1	2
08h / 00h / 3Eh	Synth Brass3	2
10h / 00h / 3Eh	AnalogBrass1	2
00h / 00h / 3Fh	Synth Brass2	2
08h / 00h / 3Fh	Synth Brass4	1
10h / 00h / 3Fh	AnalogBrass2	2
00h / 00h / 40h	GS Sop.Sax	1
00h / 00h / 41h	Alto Sax	1
08h / 00h / 41h	Blow Sax	1
00h / 00h / 42h	Tenor Sax	1
08h / 00h / 42h	Blow Sax	1
00h / 00h / 43h	Baritone Sax	1
00h / 00h / 44h	GS Oboe	1
00h / 00h / 45h	English Horn	1
00h / 00h / 46h	Bassoon	1
00h / 00h / 47h	Clarinet	1
00h / 00h / 48h	Piccolo	1
00h / 00h / 49h	GS Flute	1

CC0 / CC32 / PC	Voice Name	Voice Number
00h / 00h / 4Ah	Recorder	1
00h / 00h / 4Bh	Pan Flute	1
00h / 00h / 4Ch	Bottle Blow	2
00h / 00h / 4Dh	Shakuhachi	2
00h / 00h / 4Eh	Whistle	1
00h / 00h / 4Fh	Ocarina	1
00h / 00h / 50h	Square Wave	2
01h / 00h / 50h	Square	1
08h / 00h / 50h	Sine Wave	1
00h / 00h / 51h	Saw Wave	2
01h / 00h / 51h	Saw	1
08h / 00h / 51h	Doctor Solo	2
00h / 00h / 52h	Syn.Calliope	2
00h / 00h / 53h	Chiffer Lead	2
00h / 00h / 54h	Charang	2
00h / 00h / 55h	Solo Vox	2
00h / 00h / 56h	5th Saw Wave	2
00h / 00h / 57h	Bass & Lead	2
00h / 00h / 58h	Fantasia	2
00h / 00h / 59h	Warm Pad	1
00h / 00h / 5Ah	Polysynth	2
00h / 00h / 5Bh	Space Voice	1
00h / 00h / 5Ch	Bowed Glass	2
00h / 00h / 5Dh	Metal Pad	2
00h / 00h / 5Eh	Halo Pad	2
00h / 00h / 5Fh	Sweep Pad	1
00h / 00h / 60h	Ice Rain	2
00h / 00h / 61h	Soundtrack	2
00h / 00h / 62h	Crystal	2
01h / 00h / 62h	Syn Mallet	1
00h / 00h / 63h	Atmosphere	2
00h / 00h / 64h	Brightness	2
00h / 00h / 65h	Goblin	2
00h / 00h / 66h	Echo Drops	1
01h / 00h / 66h	Echo Bell	2
02h / 00h / 66h	Echo Pan	2
00h / 00h / 67h	Star Theme	2
00h / 00h / 68h	Sitar	1
01h / 00h / 68h	Sitar 2	2
00h / 00h / 69h	Banjo	1
00h / 00h / 6Ah	GS Shamisen	1
00h / 00h / 6Bh	Koto	1
08h / 00h / 6Bh	Taisho Koto	2
00h / 00h / 6Ch	Kalimba	1
00h / 00h / 6Dh	Bagpipe	1
00h / 00h / 6Eh	Fiddle	1
00h / 00h / 6Fh	Shanai	1
00h / 00h / 70h	Tinkle Bell	1
00h / 00h / 71h	Agogo	1
00h / 00h / 72h	Steel Drums	1
00h / 00h / 73h	Woodblock	1
08h / 00h / 73h	Castanets	1
00h / 00h / 74h	Taiko	1
08h / 00h / 74h	Concert BD	1
00h / 00h / 75h	Melo. Tom 1	1
08h / 00h / 75h	Melo. Tom 2	1
00h / 00h / 76h	Synth Drum	1
08h / 00h / 76h	80\$ Tom	1
09h / 00h / 76h	Elec Perc.	1

CC0 / CC32 / PC	Voice Name	Voice Number
00h / 00h / 77h	Reverse Cym.	1
00h / 00h / 78h	Gt.FretNoise	1
01h / 00h / 78h	Gt.Cut Noise	1
02h / 00h / 78h	String Slap	1
00h / 00h / 79h	Breath Noise	1
01h / 00h / 79h	FLKey Click	1
00h / 00h / 7Ah	Seashore	1
01h / 00h / 7Ah	Rain	1
02h / 00h / 7Ah	Thunder	1
03h / 00h / 7Ah	Wind	1
04h / 00h / 7Ah	Stream	2
05h / 00h / 7Ah	Bubble	2
00h / 00h / 7Bh	Bird	2
01h / 00h / 7Bh	Dog	1
02h / 00h / 7Bh	Horse-Gallop	1
03h / 00h / 7Bh	Bird 2	1
00h / 00h / 7Ch	Telephone 1	1
01h / 00h / 7Ch	Telephone 2	1
02h / 00h / 7Ch	DoorCreaking	1
03h / 00h / 7Ch	Door	1
04h / 00h / 7Ch	Scratch	1
05h / 00h / 7Ch	Windchime	2
00h / 00h / 7Dh	Helicopter	1
01h / 00h / 7Dh	Car-Engine	1
02h / 00h / 7Dh	Car-Stop	1
03h / 00h / 7Dh	Car-Pass	1
04h / 00h / 7Dh	Car-Crash	2
05h / 00h / 7Dh	Siren	1
06h / 00h / 7Dh	Train	1
07h / 00h / 7Dh	Jetplane	2
08h / 00h / 7Dh	Starship	2
09h / 00h / 7Dh	Burst Noise	2
00h / 00h / 7Eh	Applause	2
01h / 00h / 7Eh	Laughing	1
02h / 00h / 7Eh	Screaming	1
03h / 00h / 7Eh	Punch	1
04h / 00h / 7Eh	Heart Beat	1
05h / 00h / 7Eh	Footsteps	1
00h / 00h / 7Fh	Gun Shot	1
01h / 00h / 7Fh	Machine Gun	1
02h / 00h / 7Fh	Lasergun	1
03h / 00h / 7Fh	Explosion	2
00h / 40h / 00h	Grand Piano 1	2-4
00h / 40h / 01h	Piano 2	1
08h / 40h / 01h	Grand Piano2	2-4
08h / 40h / 02h	Rock Piano	2
08h / 40h / 03h	Honky-tonk 1	2-4
08h / 40h / 04h	Soft E.Piano	2
10h / 40h / 04h	E.Piano 1	2
18h / 40h / 04h	Sine Rhodes	1
00h / 40h / 05h	Hard E.Piano	2
08h / 40h / 05h	St.FM EP	2
10h / 40h / 05h	E.Piano 2	1
00h / 40h / 07h	Analog Clav.	2
00h / 40h / 0Ah	Music Box	1
00h / 40h / 0Fh	Santur	2
20h / 40h / 10h	VS Organ	2
00h / 40h / 11h	Jazz Organ 1	2

CC0 / CC32 / PC	Voice Name	Voice Number
08h / 40h / 11h	Jazz Organ 3	2
20h / 40h / 11h	Jazz Organ 2	2
00h / 40h / 12h	Rock Organ 1	2
00h / 40h / 13h	Organ Flute	1
08h / 40h / 13h	Trem.Flute	2
10h / 40h / 13h	Theater Org.	2
00h / 40h / 14h	Digi Church	2
00h / 40h / 15h	Accordion	1
00h / 40h / 16h	Harmonica	1
00h / 40h / 18h	Nylon Guitar	1
08h / 40h / 18h	Gut Guitar	1
10h / 40h / 18h	Nylon Gt.o	2
20h / 40h / 18h	Nylon Gt.2	1
00h / 40h / 19h	Steel Guitar	1
08h / 40h / 19h	12str Guitar	2
10h / 40h / 19h	Mandolin	1
08h / 40h / 1Ah	Hawaiian Gt.	1
00h / 40h / 1Bh	JC E.Guitar	2
00h / 40h / 1Ch	Muted Dis.Gt	1
00h / 40h / 1Eh	DistortionGt	1
08h / 40h / 1Eh	Power Gt.2	2
00h / 40h / 20h	Acoustic Bs.	2
00h / 40h / 21h	Fingered Bs.	1
00h / 40h / 22h	Picked Bs.	1
10h / 40h / 27h	SH101 Bass	1
00h / 40h / 28h	Violin	1
00h / 40h / 2Ah	Cello	1
00h / 40h / 2Eh	Harp	1
00h / 40h / 35h	Jazz Scat	2
00h / 40h / 36h	Choir Oohs	2
00h / 40h / 38h	Trumpet	1
00h / 40h / 39h	Trombone	1
00h / 40h / 3Ch	Fr.Horn Solo	1
00h / 40h / 40h	Soprano Sax	1
00h / 40h / 42h	Blow Sax	1
00h / 40h / 44h	Ohoe	1
00h / 40h / 49h	Flute	1
00h / 40h / 4Bh	Blow Pipe	1
00h / 40h / 50h	Syn Square	2
01h / 40h / 50h	FM Lead 1	2
08h / 40h / 50h	JP8 Square	1
00h / 40h / 51h	Mg Lead	1
01h / 40h / 51h	P5 Saw Lead	1
08h / 40h / 51h	Rhythmic Saw	2
00h / 40h / 52h	JP8 Pulse	2
00h / 40h / 53h	Cheese Saw	1
00h / 40h / 54h	Reso Saw	1
00h / 40h / 55h	RAVE Vox	2
00h / 40h / 56h	5th Lead	2
00h / 40h / 57h	FM Lead 2	1
00h / 40h / 58h	Fantasia 2	2
00h / 40h / 59h	Soft Pad	2
00h / 40h / 5Ah	P5 Poly	2
00h / 40h / 5Bh	Heaven II	2
00h / 40h / 5Dh	Tine Pad	2
00h / 40h / 5Eh	JP8 Sqr Pad	2
00h / 40h / 5Fh	Sweep Pad 2	2
00h / 40h / 60h	LFO RAVE	2
00h / 40h / 61h	Ancestral	2

CC0 / CC32 / PC	Voice Name	Voice Number
00h / 40h / 62h	Vibra Bells	2
00h / 40h / 63h	Harpvox	2
00h / 40h / 65h	Calculating	2
00h / 40h / 66h	Big Panner	2
01h / 40h / 66h	Ai-yai-a	2
02h / 40h / 66h	Echo Pan 2	2
00h / 40h / 6Ah	Shamisen	2
01h / 40h / 78h	Wah Brush Gt	1
06h / 40h / 78h	Pick Scrape	1
02h / 40h / 7Ah	Thunder Bell	2
04h / 40h / 7Bh	Cat	1
05h / 40h / 7Ch	Bar Chimes	1
07h / 40h / 7Dh	Falling Down	2
07h / 40h / 7Eh	Finger Snap	1
00h / 41h / 00h	MIDI Piano1	2
00h / 41h / 01h	MIDI Piano2	2
00h / 41h / 02h	EG+Rhodes 1	2
00h / 41h / 04h	Hard Rhodes	2
00h / 41h / 05h	E.Piano 3	1
08h / 41h / 05h	FM+SA EP	2
00h / 41h / 07h	5th Ana.Clav	2
00h / 41h / 10h	Full Organ 1	1
08h / 41h / 10h	Full Organ 2	1
10h / 41h / 10h	Full Organ 3	1
20h / 41h / 10h	Full Organ 4	1
00h / 41h / 11h	Jazz Organ 4	2
08h / 41h / 11h	Organ Bass	2
20h / 41h / 11h	Pipe Org. Bs	2
00h / 41h / 12h	Rotary Org.S	1
00h / 41h / 18h	Gut Guitar	1
08h / 41h / 19h	Nylon+Steel	2
00h / 41h / 1Eh	Dazed Guitar	2
08h / 41h / 1Eh	Power Guitar	2
00h / 41h / 20h	A.Bass+Cymb	2
00h / 41h / 22h	Mute PickBs.	1
00h / 41h / 35h	Doos Voice	1
00h / 41h / 50h	CC Solo 2	2
00h / 41h / 5Dh	Panner Pad	2
00h / 41h / 5Fh	Polar Pad	1
00h / 41h / 61h	Prologue	2
00h / 41h / 62h	Clear Bells	2
00h / 41h / 63h	Nylon Harp	2
00h / 41h / 65h	Goblinson	2
02h / 41h / 66h	Water Piano	2
00h / 42h / 02h	EG+Rhodes 2	2
08h / 42h / 05h	Hard FM EP	2
10h / 42h / 05h	Hard E.Piano	2
00h / 42h / 10h	Lower Organ1	1
08h / 42h / 10h	Lower Organ2	1
10h / 42h / 10h	Lower Organ3	1
20h / 42h / 10h	Metalic Org.	2
00h / 42h / 11h	Jazz Organ 5	2
08h / 42h / 11h	Jazz Organ 6	2
20h / 42h / 11h	Jazz Organ 7	2
00h / 42h / 12h	Rotary Org.F	1
00h / 42h / 1Eh	Rock Rhythm2	2
08h / 42h / 1Eh	Rock Rhythm	2

CC0 / CC32 / PC	Voice Name	Voice Number
00h / 42h / 35h	Thum Voice	1
00h / 42h / 5Fh	Converge	1
00h / 42h / 62h	ChristmasBel	2
00h / 42h / 63h	Nylon+Rhodes	2
00h / 42h / 65h	50's Sci-Fi	2
00h / 43h / 10h	Full Organ 5	2
08h / 43h / 10h	Full Organ 6	2
10h / 43h / 10h	Full Organ 7	2
20h / 43h / 10h	Full Organ 8	2
00h / 43h / 35h	Doot Accent	1
00h / 44h / 35h	Dat Accent	1
00h / 45h / 35h	Bop Accent	1
00h / 46h / 35h	Doos & Doot	2
00h / 47h / 35h	Dat & Bop	2

●Drum Set

CC0 / CC32 / PC#	Drum Set Name
00h / 40h / 00h	STANDARD 2
00h / 40h / 08h	ROOM 2
00h / 00h / 10h	POWER
00h / 00h / 18h	ELECTRONIC
00h / 00h / 19h	TR-808
00h / 40h / 19h	DANCE
00h / 00h / 20h	JAZZ
00h / 40h / 28h	BRUSH 2
00h / 00h / 30h	ORCHESTRA
00h / 00h / 00h	STANDARD
00h / 00h / 08h	ROOM
00h / 00h / 28h	BRUSH
00h / 00h / 38h	SOUND EFFECT

Function...		Transmitted	Recognized	Remarks	
Basic Channel	Default	12 (Lower) 13 (Upper) 14 (Pedal Bass) 16 (Solo, Expression, PC)	1-16 1-16 1-16 1-16		
	Changed	1-16	1-16		
Mode	Default Messages Altered	x x *****	Mode 3 Mode 3, 4(M=1)	* 3	
Note Number :	True Voice	36-96 *****	0-127 0-127		
Velocity	Note ON Note OFF	O x 8n v=64	*1 O x		
After Touch	Key's Ch's	x x	O O	*2 *2	
Pitch Bend		x	O	*2	
Control Change	0, 32	O	*1 O	*3 *2	Bank select Modulation Portamento time Data entry Volume Panpot Expression (MSB) Glide Expression (LSB) Hold 1 Portamento Sostenuto Soft Portamento control Effect1 depth Effect3 depth NRPN LSB, MSB RPN LSB, MSB
	1	x	O	*2	
	5	x	O	*2	
	6, 38	x	O	*2	
	7	x	O	*2	
	10	x	O	*3	
	11	O	O	*3	
	16	x	O	*4	
	43	O	x		
	64	O	O	*3	
	65	x	O	*3	
	66	x	O	*2	
	67	x	O	*2	
	84	x	O	*2	
	91	x	O	*3	
	93	x	O	*3	
	98, 99	x	O	*3	
	100, 101	x	O	*2	
Prog Change : True #		0-127 *****	*1 O 0-127	*3 Program number 1-128	
System Exclusive		x	O		
System Common	: Song Pos : Song Sel : Tune	x x x	x x x		
System Real Time	: Clock : Commands	O O	x x		
Aux Message	: All sound off : Reset all controllers : Local Control : All Notes OFF : Active Sense : Reset	x x x x O x	O (120, 126, 127) O x O (123-125) O x		
Notes	* 1 O x is selectable. * 2 O x is selectable by SysEx. * 3 Recognize only GS Part. * 4 Recognize only Keyboard Part. * 5 Recognize as M=1 even if M≠1.				

Mode 1 : OMNI ON, POLY
Mode 3 : OMNI OFF, POLY

Mode 2 : OMNI ON, MONO
Mode 4 : OMNI OFF, MONO

O : Yes
X : No

Demo Song List

To play the Demo Songs, please refer to "Listening to the Demo Songs" (p. 20).

Song Title	Composer	Player	Copyright
Big Band	Ric Iannone	Ric Iannone	© 1999 Roland Corporation
Jazz Scat	Ric Iannone	Ric Iannone	© 1999 Roland Corporation
TheaterOrgan	Jonas Nordwall	Jonas Nordwall	© 1995 Rodgers Instruments LLC
Choir	Hector Olivera	Hector Olivera	© 1999 Roland Corporation
Gregorian	Ric Iannone	Ric Iannone	© 1999 Roland Corporation

* All rights reserved. Unauthorized use of this material for purposes other than private, personal enjoyment is a violation of applicable laws.

* The data for the Demo song that is being played is not available at the MIDI Out connector.

■ Profile

Hector Olivera

Hector Olivera was born in Argentina. He received his education at the Conservatory and the University of Buenos Aires followed by a scholarship at the famous Juilliard School of Music in New York. Olivera has performed extensively throughout the world including concerts at prestigious places such as the Notre Dame Cathedral in Paris and Carnegie Hall in New York. Hector Olivera's expertise involves both the traditional pipe organ and the electronic organ. Presently Olivera tours internationally playing some of the world's most magnificent pipe organs as well as his preferred electronic organ, the Roland Atelier for which he continues to collaborate with its development.

Jonas Nordwall

A native of Portland, Mr. Nordwall received his Bachelor of Music Degree in 1970 from the University of Portland studying with Arthur Hitchcock. Additional study was done with Frederick Geoghegan, the noted English/Canadian organist. As a teenager, Jonas had the privilege to study with Richard Ellsasser, one of the greatest virtuoso organist of this century.

Besides serving as Director of Music for the First United Methodist Church in Portland, Oregon and as the Organist for the Oregon Symphony Orchestra.

He has been a featured recitalist for national conventions of the American Theatre Organ Society and was Organist of the year for 1987.

Ric Iannone

Ric Iannone began playing the piano and accordion at the age of two and a half. By the time he was seven, he was performing public and private engagements with his musician father. For more than 20 years Ric has performed and traveled extensively throughout the United States and Europe, delighting audiences with his unique playing style and music arrangements. He is equally comfortable playing the organ, piano or keyboard, as a concert artist and product demonstrator.

Main Specifications

AT-60R:Music Atelier

Keyboard

Upper 49 Keys Lower 61 Keys;
Pedalboard 20 notes

Voices (247 Voices)

Upper Organ:

Full, Jazz, Rock, Pipe, Theater etc.

Upper Symphonic:

Strings, Slow Strings, Synth Strings, Synth Pad, Choir etc.

Upper Orchestral:

Piano, E.Piano, A.Guitar, E.Guitar, Brass, Harpsi, Harp,
Vibes, Marimba, Mandolin, Banjo, Accordion, Harmonica
etc.

Lower Organ:

Full, Lower, Pipe, Theater etc.

Lower Symphonic:

Strings, Synth Strings, Choir etc.

Lower Orchestral:

Piano, E.Piano, A.Guitar, Brass, Harpsi, Harp, Vibes,
Marimba, Accordion, Harmonica etc.

Solo:

Violin, Trumpet, Sax, Flute, Oboe, Clarinet etc.

Pedal Organ:

Organ, Pipe, Theater etc.

Pedal Orchestral:

String, Contrabass, Electric, etc.

* Any two of the 210 voices (except the preset ones) can be assigned to each [Others] button. (One for Pedal Organ and Pedal Orchestral Others buttons.)

Rhythms (96 Rhythms, Variation/Original)

Big Band, Swing, Country, Oldies, Ballad, Trad, Acoustic, World, Latin1, Latin2, Showtime, Pop1, Pop2, Gospel, Waltz/March, Disk etc.

* Music Style Disks (MSA series; sold separately) can provide additional Music Styles.

Number of accompaniment/SMF play voices

226 Voices

Number of Manual Drums sets

12 Sets

Number of Sound Effects sets

1 Set

Number of Manual Percussion sets

3 Set

Effects

Rotary Sound, Chorus, Reverb, Sustain, Vibrato, Pitch Bend, Glide

Harmony Intelligence

Organ, Combo, Strings, Hymn, Block, Harp, Jazz Scat, Big Band, Broadway, Traditional, Octave1, Octave2

Arranger function

Arranger On/Off, Start/Stop, Intro/Ending, Sync Start, Fill In (Variation/Original), Leading Bass, Advanced/Basic, Break, Chord Intelligence, One Touch Program

Number of Registration memories

12

Composer

Tracks: 7
Note Storage : approx. 40,000 notes
Song Length: max. 999 measures
Tempo: Quarter note = 20 to 250
Resolution: 120 ticks per quarter note
Recording: Realtime

Main Specifications

Storage: 3.5 inch micro floppy disk

Disk format:

720 K bytes (2DD), 1.44 M bytes (2HD)

Songs:

max. 56 (2DD), max. 99 (2HD)

Rated power output

40 W x 2, 80 W (low-range)

Speakers

full-range (Small): 8 cm x 2

3-3/16 inches x 2

full-range (Large): 16 cm x 2

6-5/16 inches x 2

woofer: 25 cm x 1

9-7/8 inches x 1

Display

16 characters, 2 lines (backlit LCD)

Disk drive

3.5 inch micro floppy disk drive (2DD/2HD)

Pedals

Damper pedal

Expression pedal

Two foot switches (assignable)

Connectors

Phones jack (Stereo)

AC inlet

Pedal jack

MIDI connectors (In/Out)

Audio output jacks (L(MONO)/R)

Audio input jacks (L(MONO)/R)

Mic jack

Computer connector

Power supply

AC 117 V, AC 230 V or AC 240 V

Power consumption

250 W (AC 117 V)

180 W (AC 230 V)

180 W (AC 240 V)

Finish

Satin Mahogany

Dimensions

Body (Including music rest) :

1246 (W) x 611 (D) x 486 (H) mm

49-1/16 (W) x 24-1/16 (D) x 19-3/16 (H) inches

Stand:

1223 (W) x 565 (D) x 756 (H) mm

48-3/16 (W) x 22-1/4 (D) x 29-13/16 (H) inches

Total (Including music rest) :

1246 (W) x 611 (D) x 1242 (H) mm

49-1/16 (W) x 24-1/16 (D) x 48-15/16 (H) inches

Bench:

700 (W) x 335 (D) x 600 (H) mm

27-9/16 (W) x 13-3/16 (D) x 23-5/8 (H) inches

Weight

Body: 52.0 kg / 114 lbs 11 oz

Stand: 54.0 kg / 119 lbs 1 oz

Total: 106.0 kg / 233 lbs 1 oz

Bench: 9.5 kg / 21 lbs

Accessories

Bench

Owner's manual

3.5 inch micro floppy disk (2HD) (Blank Disk)

Music Style Disk

World Style Setup Disk

Power Cord

* In the interest of product improvement, the specifications and/or appearance of this unit are subject to change without prior notice.

Index

- A**
- All Song Play 20, 89
 - Arrangement 40
 - Arranger 41, 44
 - Automatic Accompaniment 41, 44
- B**
- Basic Pitch 113
 - Basic Screen 19
 - Bass Pedalboard 22
 - Bass Split 57
 - Bass Split Point 57, 110
 - Bass To Lower 58
 - Beat 96
 - Beat Indicator 41
 - Break 40, 108
 - Brightness of the Sound 61
- C**
- Chord 41–43
 - Chord Hold 110
 - Chord Intelligence 42
 - Chorus Effect 52
 - Composer 74, 95
 - Composer Screen 19
 - Computer 115
 - Coping
 - Name of Registration 67
 - Copy
 - measure 102
 - Count-In 75
 - Count-In Recording 95
- D**
- Damper Pedal 60, 109
 - Delete
 - Measure 99
 - Track 100
 - Deleting
 - Registration 71
 - Demo Song 20
 - Disk Drive 46
 - Display of Lyrics 98
 - Drum Set 33, 35
- E**
- Echo 17
 - Eject Button 46
 - Ending 39, 108
 - Erase 101
 - Portion of Performance Data 101
 - Erasing
 - Performance Song 80
 - Performance Song on Floppy Disk 90
 - Expression Pedal 60
 - Depth of Effect 111
 - Function 96
- F**
- Factory Default Settings 18
 - Factory Reset 18
 - Fill In
 - Fill In To Original 40, 108
 - Fill In To Variation 40, 108
 - Floppy Disk 46
 - Format 81
 - Foot Switch 62, 107
 - Format 81
- G**
- Glide 108
- H**
- Harmony Intelligence 49, 109
 - Headphones 17
 - Human Voice 32
- I**
- Initial Touch 107
 - Intro 38, 108
- L**
- LCD Contrast 113
 - Leading Bass 108
 - Loading
 - Disk Rhythm 47
 - Performance Songs 87
 - Registration 69
 - Loop Recording 93
 - Lower Keyboard 22
 - Lower Voice 23–24
- M**
- Manual Drums 33
 - Manual Drums Set 33, 109
 - Manual Percussion 35
 - Manual Percussion Set 35, 110
 - Master Tuning 113
 - Metronome 95
 - Metronome Sound 95
 - Metronome Volume 95
 - Microphone 17
 - MIDI 116
 - MIDI IN Mode 112
 - MIDI Output Channel 112
 - Music Style Disk 46
 - Muting Channel 97
- N**
- Name
 - Performance Song 83

Index

- O**
Octave Shift31
One Touch Program44
- P**
Panel Settings45
Part22
PC Number113
Pedal60
Pedal Bass Mode
 How the Bass Pedalboard Can Be Played107
Pedal Bass Voice23, 26
Pitch Bend61
Pitch Bend Range109
Pitch Bend/Vibrato Lever61
Playing
 Demo Song20
 Performance Song on Floppy Disk89
Punch-in Recording91
- Q**
Quantize103
- R**
Recording75–76, 79
Registration63
 Assigning a Name65
 Coping the Name67
 Created on an Earlier Model72
 Delete71
 Load69
 Name65
 Recall64
 Recall Timing111
 Save68
 Store63
Reverb Effect53
 Reverb Depth105
 Reverb Type104
Rhythm37
 Arrangement40
 Break40
 Ending39
 Fill In40
 Intro38
 Starting and Stopping38, 108
Rhythm Screen19
Rotary Effect51
 Rotary Color105
 Rotary Speed105
- S**
Saving
 Performance Song84
 Registration68
 SMF84
 SMF Format86
SMF Format88–89
 Save86
SMF Song Files89
Solo Split Point56, 110
Solo To Lower56
Solo Voice27
 Changing How the Solo Voice Will Sound107
 Layering the Lower Voice110
Sound Effects33, 35
Sustain Effect53
 Sustain Length105
Sync Start38, 44
- T**
Tempo41
Track74
Track Mute78
Transpose59
- U**
Upper Keyboard22
Upper Voice23–24
- V**
Vibrato Effect61
Volume
 Master16, 60
 Metronome95
 Microphone17
Volume Balance30

MEMO

Information

When you need repair service, call your nearest Roland Service Center or authorized Roland distributor in your country as shown below.

AFRICA

EGYPT

Al Fanny Trading Office
P.O. Box 2904,
El Horrieh Heliopolis, Cairo,
EGYPT
TEL: (02) 4185531

REUNION

Maison FO - YAM Marcel
25 Rue Jules MermanZL
Chaudron - BP79 97491
Ste Clotilde REUNION
TEL: 28 29 16

SOUTH AFRICA

That Other Music Shop (PTY) Ltd.
11 Melle Street (Cnr Melle and Juta Street)
Braamfontein 2001
Republic of SOUTH AFRICA
TEL: (011) 403 4105

Paul Bothner (PTY) Ltd.
17 Werdmuller Centre Claremont
7700
Republic of SOUTH AFRICA
P.O. Box 23032
Claremont, Cape Town
SOUTH AFRICA, 7735
TEL: (021) 64 4030

ASIA

CHINA

Beijing Xinghai Musical Instruments Co., Ltd.
6 Huangmuyang Chao Yang District, Beijing, CHINA
TEL: (010) 6774 7491

HONG KONG

Tom Lee Music Co., Ltd. Service Division
22-32 Pun Shan Street, Tsuen Wan, New Territories,
HONG KONG
TEL: 2415 0911

INDIA

Rivera Digitec (India) Pvt. Ltd.
409, Nirman Kendra Mahalaxmi Flats, Compound off. Dr. Edwin Moses Road, Mumbai 400011, INDIA
TEL: (022) 498 3079

INDONESIA

PT Galestra Inti
Kompleks Perkantoran Duta Merlin Blok F No.6-7 Jl. Gajah Mada No.3-5, Jakarta 10130,
INDONESIA
TEL: (021) 6335416

KOREA

Cosmos Corporation Service Station
261 2nd Floor Nak-Won Arcade Jeng-Ro ku, Seoul, KOREA
TEL: (02) 742 8844

MALAYSIA

Bentley Music SDN BHD
140 & 142, Jalan Bukit Bintang 55100 Kuala Lumpur, MALAYSIA
TEL: (03) 2443333

PHILIPPINES

G.A. Yupangco & Co. Inc.
339 Gil J. Puyat Avenue Makati, Metro Manila 1200,
PHILIPPINES
TEL: (02) 899 9801

SINGAPORE

Swee Lee Company
150 Sims Drive,
SINGAPORE 387381
TEL: 748-1669

CRISTOFORI MUSIC PTE LTD

Blk 3014, Bedok Industrial Park E,
#02-2148, SINGAPORE 489980
TEL: 243 9555

TAIWAN

ROLAND TAIWAN ENTERPRISE CO., LTD.
Room 5, 9fl. No. 112 Chung Shan N.Road Sec.2, Taipei, TAIWAN, R.O.C.
TEL: (02) 2561 3339

THAILAND

Theera Music Co., Ltd.
330 Vermg NakornKasem, Soi 2, Bangkok 10100, THAILAND
TEL: (02) 2248821

VIETNAM

Saigon Music
138 Tran Quang Khai St., District 1
Ho chi minh City
VIETNAM
TEL: (8) 844-4068

AUSTRALIA/NEW ZEALAND

AUSTRALIA

Roland Corporation Australia Pty. Ltd.
38 Campbell Avenue
Dee Why West, NSW 2099
AUSTRALIA
TEL: (02) 9982 8266

NEW ZEALAND

Roland Corporation (NZ) Ltd.
97 Mt. Eden Road, Mt. Eden, Auckland 3, NEW ZEALAND
TEL: (09) 3098 715

CENTRAL/LATIN AMERICA

ARGENTINA

Instrumentos Musicales S.A.
Florida 656 2nd Floor
Office Number 206A
Buenos Aires
ARGENTINA, CP1005
TEL: (54-11) 4-393-6057

BRAZIL

Roland Brasil Ltda.
R. Coronel Octaviano da Silveira
203 05522-010
Sao Paulo BRAZIL
TEL: (011) 843 9377

CHILE

Comercial Fancy S.A.
Avenida Rancagua #0330
Providencia Santiago, CHILE
TEL: 56-2-373-9100

EL SALVADOR

OMNI MUSIC
75 Avenida Notre y Alameda
Juan Pablo 2 No. 4010
San Salvador, EL SALVADOR
TEL: (503) 262-0788

MEXICO

Casa Veerkamp, s.a. de c.v.
Av. Toluca No. 323 Col. Olivar de los Padres 01780 Mexico D.F.
MEXICO
TEL: (525) 668 04 80

La Casa Wagner de Guadalajara s.a. de c.v.
Av. Corona No. 202 S.J.
Guadalajara, Jalisco Mexico
C.P.44100 MEXICO
TEL: (03) 613 1414

PANAMA

Productos Superiores, S.A.
Apartado 655 - Panama 1
REP. DE PANAMA
TEL: (507) 270-2200

URUGUAY

Todo Musica
Cuareim 1488, Montevideo,
URUGUAY
TEL: 5982-924-2335

VENEZUELA

Musidand Digital C.A.
Av. Francisco de Miranda,
Centro Parque de Cristal, Nivel
C2 Local 20 Caracas
VENEZUELA
TEL: (02) 285 9218

EUROPE

AUSTRIA

Roland Austria GES.M.B.H.
Siemensstrasse 4, P.O. Box 74,
A-6063 RUM, AUSTRIA
TEL: (0512) 26 44 260

BELGIUM/HOLLAND/ LUXEMBOURG

Roland Benelux N. V.
Houtstraat 3 B-2260 Oevel
(Westerlo) BELGIUM
TEL: (014) 575811

DENMARK

Roland Scandinavia A/S
Langebrogade 6 Post Box 1937
DK-1023 Copenhagen K,
DENMARK
TEL: 32 95 3111

FRANCE

Roland France SA
4, Rue Paul Henri SPAAK
Parc de l'Esplanade F 77 462 St.
Thibault Lagny Cedex FRANCE
TEL: 01 600 73 500

FINLAND

Roland Scandinavia As, Filial Finland
Lautasaarentie 54 B
Fin-00201 Helsinki, FINLAND
TEL: (9) 682 4020

GERMANY

Roland Elektronische Musikinstrumente Handelsgesellschaft mbH.
Oststrasse 96, 22844 Norderstedt,
GERMANY
TEL: (040) 52 60090

GREECE

V. Dimitriadis & Co. Ltd.
20, Alexandras St. & Bouboulinas
54 St. 106 82 Athens, GREECE
TEL: (01) 8227 775

HUNGARY

Intermusica Ltd.
Warehouse Area 'DEPO' P/83
H-2046 Torokbalint, HUNGARY
TEL: (23) 511011

IRELAND

Roland Ireland
Audio House, Belmont Court,
Donnybrook, Dublin 4,
Republic of IRELAND
TEL: (01) 2603501

ITALY

Roland Italy S. p. A.
Viale delle Industrie, 8
20020 Arese Milano, ITALY
TEL: (02) 937-78300

NORWAY

Roland Scandinavia Avd. Kontor Norge
Lilleakerveien 2 Postboks 95
Lilleaker N-0216 Oslo
NORWAY
TEL: 273 0074

POLAND

P. P. H. Brzostowicz
UL. Gibraltarska 4,
PL-03664 Warszawa POLAND
TEL: (022) 679 44 19

PORTUGAL

Tecnologias Musica e Audio, Roland Portugal, S.A.
RUA SANTA CATARINA
131 - 4000 Porto -PORTUGAL
TEL: (02) 208 44 56

ROMANIA

FBS LINES
Plata Libertatii 1,
RO-4200 Cheorgheni
TEL: (066) 164-609

RUSSIA

Slami Music Company
Sadovaya-Triumfalnaja st., 16
103006 Moscow, RUSSIA
TEL: 095 209 2193

SPAIN

Roland Electronics de España, S. A.
Calle Bolivia 239 08020 Barcelona,
SPAIN
TEL: (93) 308 1000

SWEDEN

Roland Scandinavia A/S SWEDISH SALES OFFICE
Danvik Center 28, 2 tr.
S-131 30 Nacka SWEDEN
TEL: (08) 702 0020

SWITZERLAND

Roland (Switzerland) AG Musitronic AG
Gerberstrasse 5, CH-4410 Liestal,
SWITZERLAND
TEL: (061) 921 1615

UKRAINE

TIC-TAC
Mira Str. 19/108
P.O. Box 180
295400 Mukachevo, UKRAINE
TEL: (03131) 414-40

UNITED KINGDOM

Roland (U.K.) Ltd.
Atlantic Close, Swansea
Enterprise Park SWANSEA
SA7 9FJ,
UNITED KINGDOM
TEL: (01792) 700139

MIDDLE EAST

BAHRAIN

Moon Stores
Bab Al Bahrain Road,
P.O. Box 20077
State of BAHRAIN
TEL: 211 005

CYPRUS

Radex Sound Equipment Ltd.
17 Diagorou St., P.O. Box 2046,
Nicosia CYPRUS
TEL: (02) 453 426

ISRAEL

Halilit P. Greenspoon & Sons Ltd.
8 Retzif Fa'aliya Hashva St.
Tel-Aviv-Yahvo ISRAEL
TEL: (03) 6823666

JORDAN

AMMAN Trading Agency
Prince Mohammed St. P.O. Box
825 Amman 11118 JORDAN
TEL: (06) 4641200

KUWAIT

Easa Husain Al-Yousifi
P.O. Box 126 Safat 13002
KUWAIT
TEL: 5719499

LEBANON

A. Chahine & Fils
P.O. Box 16-5857 Gergi Zeidan St.
Chahine Building, Achrafieh
Beirut, LFBANON
TEL: (01) 335799

OMAN

OHI Electronics & Trading Co. LLC
P.O. Box 889 Muscat
Sultanate of OMAN
TEL: 959085

QATAR

Badie Studio & Stores
P.O. Box 62,
DOHA QATAR
TEL: 423554

SAUDI ARABIA

aDawlah Universal Electronics APL
P.O. Box 2154 ALKHOBAR 31952,
SAUDI ARABIA
TEL: (03) 898 2081

SYRIA

Technical Light & Sound Center
Khaled Ibn Al Wahd St.
P.O. Box 13520
Damascus - SYRIA
TEL: (011) 2235 364

TURKEY

Barkat Muzik aletleri ithalat ve ihracat limited ireketi
Sirasesiyer Cad. Guney Ishani No.
86/6 Taksim, Istanbul TURKEY
TEL: (0212) 2499324

U.A.E.

Zak Electronics & Musical Instruments Co.
Zabeel Road, Al Sherooq Bldg.,
No. 14, Grand Floor DUBAI
U.A.E.
P.O. Box 8050 DUBAI, U.A.E.
TEL: (04) 360715

NORTH AMERICA

CANADA

Roland Canada Music Ltd. (Head Office)
5480 Parkwood Way Richmond
B. C., V6V 2M4 CANADA
TEL: (0604) 270 6626

Roland Canada Music Ltd. (Toronto Office)

Unit 2, 109 Woodbine Downs
Blvd, Etobicoke, ON
M9W 6Y1 CANADA
TEL: (0416) 213 9707

U. S. A.

Roland Corporation U.S.
7200 Dominion Circle
Los Angeles, CA. 90040-3696,
U. S. A.
TEL: (0323) 685 5141



Voice/Rhythm List

ボイス／リズム対応表

Voice List

AT-R		AT-90R/ AT-80R	AT-60R	AT-30R	AT-20R	AT-90/AT-80 Voice No.	AT-30 Voice No.
Voice No.	Tone Name						
A11	Full Organ1	o	o	o	o	001	001
A12	Full Organ2	o	o	o	o	003	003
A13	Full Organ3	o	o	o	o	005	005
A14	Full Organ4	o	o	o	o	002	002
A15	Full Organ5	o	o	o	o	004	004
A16	Full Organ6	o	o	o	o	006	006
A17	Full Organ7	o	o	o	-	033	033
A18	Full Organ8	o	-	-	-	-	-
A19	Full Organ9	o	-	-	-	-	-
B11	Jazz Organ1	o	o	o	o	007	007
B12	Jazz Organ2	o	o	o	o	009	009
B13	Jazz Organ3	o	o	o	o	011	011
B14	Jazz Organ4	o	o	o	o	008	008
B15	Jazz Organ5	o	o	o	o	010	010
B16	Jazz Organ6	o	o	o	o	012	012
B21	Rock Organ1	o	o	o	o	013	013
B22	Rock Organ2	o	o	o	o	014	014
C11	Lower Organ1	o	o	o	o	015	015
C12	Lower Organ2	o	o	o	o	017	017
C13	Lower Organ3	o	o	o	o	019	019
C14	Lower Organ4	o	o	o	o	016	016
C15	Lower Organ5	o	o	o	o	018	018
C16	Lower Organ6	o	o	o	o	020	020
D11	Pipe Organ1	o	o	o	o	021	021
D12	Pipe Organ2	o	o	o	o	023	023
D13	Pipe Organ3	o	o	o	o	025	025
D14	Pipe Organ4	o	o	o	o	022	022
D15	Pipe Organ5	o	o	o	o	024	024
D16	Pipe Organ6	o	o	o	o	026	026
D17	Pipe Organ7	o	o	o	o	034	034
D21	Diapason 8'	o	o	o	o	-	-
D22	FluteCeleste	o	o	o	-	021a	-
D23	Gemshorn 8'	o	o	-	-	034a	-
D24	Trompet 8'	o	o	-	-	034b	-
D25	Hautbois 8'	o	o	-	-	034c	-
D26	Viola 8'	o	o	-	-	034d	-
D27	ViolaCeleste	o	o	-	-	034e	-
D28	Bombarde16'	o	o	-	-	-	-
D31	T.String 8'	o	o	-	-	035a	-
D32	VoxHumana 8'	o	o	-	-	035b	-
D33	T.Tuba 8'	o	o	-	-	035c	-
D34	T.Trumpet 8'	o	o	-	-	035d	-
D35	T.Sax 8'	o	o	-	-	035e	-
D36	T.Oboe 8'	o	o	-	-	035f	-
D37	T.Krumet 8'	o	o	-	-	035g	-
D38	Eng.Horn 8'	o	o	-	-	035h	-
E11	Theater Or.1	o	o	o	o	027	027
E12	Theater Or.2	o	o	o	o	029	029
E13	Theater Or.3	o	o	o	o	031	031
E14	Theater Or.4	o	o	o	o	028	028
E15	Theater Or.5	o	o	o	o	030	030
E16	Theater Or.6	o	o	o	o	032	032
E17	Theater Or.7	o	o	o	-	035	035
F11	Synth. Org.1	o	o	o	o	036	036
F12	Synth. Org.2	o	o	o	o	037	037
F13	Synth. Org.3	o	o	-	-	036a	-
F14	Synth. Org.4	o	o	-	-	037a	-
F15	Digi Church	o	-	-	-	-	-
F16	Metalic Org	o	-	-	-	-	-
F21	Pop. Organ1	o	o	o	-	038	038
F22	Pop. Organ2	o	o	o	-	039	039
F23	Pop. Organ3	o	o	o	-	040	040

AT-R		AT-90R/				AT-90/AT-80	AT-30
Voice No.	Tone Name	AT-80R	AT-60R	AT-30R	AT-20R	Voice No.	Voice No.
G11	Strings1	o	o	o	o	041	041
G12	Strings2	o	o	o	o	042	042
G13	Strings3	o	o	—	—	041a	—
G14	Strings4	o	o	—	—	042a	—
G15	Strings5	o	o	—	—	041b	—
G16	Strings6	o	o	—	—	041c	—
G17	Strings7	o	o	—	—	041d	—
G18	Strings8	o	o	—	—	—	—
H11	Slow Str.1	o	o	o	o	043	043
H12	Slow Str.2	o	o	o	—	044	044
H13	Slow Str.3	o	o	—	—	—	—
H21	Synth. Str.1	o	o	o	o	045	045
H22	Synth. Str.2	o	o	o	o	046	046
H23	Synth. Str.3	o	o	o	—	054	054
H31	Synth. Pad1	o	o	o	o	047	047
H32	Synth. Pad2	o	o	o	o	048	048
I11	Violin	o	o	o	o	093	093
I12	Viola	o	o	o	o	103	103
I13	Cello	o	o	o	o	094	094
I14	Pizzicato	o	o	o	o	056	056
J11	Jazz Scat	o	o	o	o	—	—
J12	Pop Voice	o	o	o	o	050	050
J13	Jazz Doo	o	o	o	o	—	—
J14	Jazz Doot	o	o	o	o	—	—
J15	Jazz Dat	o	o	o	o	—	—
J16	Jazz Bap	o	o	o	o	—	—
J17	JazzDowfall	o	o	o	o	—	—
J18	Soprano	o	—	—	—	—	—
J19	Tenor	o	—	—	—	—	—
J21	Choir	o	o	o	o	049	049
J22	Gregorian	o	o	o	—	—	—
J23	Classical	o	o	—	—	—	—
J24	Boys Choir	o	o	—	—	—	—
J25	Female 1	o	—	—	—	—	—
J26	Female 2	o	—	—	—	—	—
J27	Gospel	o	—	—	—	—	—
J31	Synth. Choir	o	o	o	—	051	051
J32	Synth. Voice	o	o	o	—	052	052
J33	Space Voice	o	o	o	—	053	053
J41	Vocal Menu	o	o	—	—	—	—
K11	Grand Piano	o	o	o	o	—	—
K12	Piano1	o	o	o	—	057	057
K13	Piano2	o	o	o	—	080	080
K14	Piano3	o	o	o	—	057a	—
K21	Honky-tonk	o	o	o	o	058	058
K22	Honky-tonk2	o	o	o	—	—	—
K31	E.Piano1	o	o	o	o	059	059
K32	E.Piano2	o	o	o	o	060	060
K33	E.Piano3	o	o	o	—	059a	—
K34	E.Piano4	o	o	o	—	—	—
K41	Harpsichord	o	o	o	o	067	067
K42	Clavi.	o	o	o	o	081	081
L11	Accordion	o	o	o	o	073	073
L12	Bandoneon	o	o	o	—	086	086
L21	Harmonica	o	o	o	o	074	074
M11	Nylon-str.Gt	o	o	o	o	061	061
M12	Nylon Gt.2	o	o	o	—	061a	—
M21	Steel-str.Gt	o	o	o	o	062	062
M22	12str Guitar	o	—	—	—	—	—
M31	Jazz Guitar	o	o	o	o	063	063
M32	Clean Guitar	o	o	o	—	063a	—
M33	JC E.Guitar	o	o	o	—	063b	—

AT-R		AT-90R/				AT-90/AT-80	AT-30
Voice No.	Tone Name	AT-80R	AT-60R	AT-30R	AT-20R	Voice No.	Voice No.
M41	Overdrive Gt	0	0	0	0	064	064
M42	Distortion Gt	0	-	-	-	-	-
M43	Power Guitar	0	-	-	-	-	-
M44	Rock Rhythm	0	-	-	-	-	-
N11	Hawaiian Gt.	0	0	0	0	087	087
N12	Banjo	0	0	0	0	072	072
N13	Mandolin	0	0	0	-	071	071
N14	Koto	0	0	0	-	068a	-
N15	Taisho Koto	0	0	0	-	068b	-
N16	Shamisen	0	0	0	-	-	-
N21	Harp	0	0	0	0	068	068
N22	Celtic Harp	0	-	-	-	-	-
N23	Nylon Harp	0	-	-	-	-	-
N24	Harpvox	0	-	-	-	-	-
N31	Sitar	0	0	0	0	091	091
N41	Organ Harp	0	0	0	-	088	088
O11	Vibraphone	0	0	0	0	069	069
O12	Glockenspiel	0	0	0	0	083	083
O13	Celesta	0	0	0	0	082	082
O14	Music Box	0	-	-	-	-	-
O21	Marimba	0	0	0	0	070	070
O22	Xylophone	0	0	0	0	084	084
O23	Barafon	0	-	-	-	-	-
O31	Tubular-bell	0	0	0	0	085	085
O41	Steel Drums	0	0	0	0	092	092
O42	Kalimba	0	0	-	-	091a	-
O51	Organ Bell	0	0	-	-	085a	-
O52	Vibra Bells	0	0	-	-	-	-
O53	Digi Bells	0	-	-	-	-	-
P11	Tp. Section	0	0	0	0	065	065
P12	Brass 1	0	-	-	-	-	-
P13	Brass 2	0	-	-	-	-	-
P14	Brass 3	0	-	-	-	-	-
P21	Fr.Horn Sect	0	0	0	0	089	089
P22	Fr.HornSect2	0	0	-	-	089a	-
P23	Fr.HornSect3	0	-	-	-	-	-
P24	Fr.HornSect4	0	-	-	-	-	-
P25	Orch.Brs Ens	0	-	-	-	-	-
P26	Muted Fr.Horn	0	-	-	-	-	-
P31	Sax.Section	0	0	0	0	066	066
P32	Sax.Section2	0	0	-	-	066a	-
P41	Synth. Brass	0	0	0	0	090	090
Q11	Trumpet	0	0	0	0	095	095
Q12	Trumpet2	0	0	-	-	095a	-
Q21	Mute Trumpet	0	0	0	0	096	096
Q22	Mute Trumpet2	0	0	-	-	096a	-
Q23	Cup Mute Tp	0	-	-	-	-	-
Q31	Trombone	0	0	0	0	105	105
Q32	Trombone2	0	0	-	-	105a	-
Q41	Flugel Horn	0	0	0	0	104	104
Q42	F.Horn Solo1	0	0	-	-	-	-
Q43	F.Horn Solo2	0	-	-	-	-	-
Q51	Soprano Sax	0	0	0	0	106	106
Q52	Soprano Sax2	0	0	-	-	106a	-
Q61	Alto Sax	0	0	0	0	097	097
Q62	Alto Sax2	0	0	-	-	097a	-
Q63	Blow Sax	0	-	-	-	-	-
Q71	Tenor Sax	0	0	0	0	098	098
Q72	Tenor Sax2	0	0	-	-	098a	-
R11	Flute	0	0	0	0	099	099
R12	Flute2	0	0	-	-	099a	-
R13	Flute3	0	0	-	-	-	-
R14	Tin Whistle	0	-	-	-	-	-

AT-R		AT-90R/				AT-90/AT-80		AT-30
Voice No.	Tone Name	AT-80R	AT-60R	AT-30R	AT-20R	Voice No.	Voice No.	
R21	Synth. Flute	0	0	0	-	055	055	
R22	Pan Flute	0	0	0	0	100	100	
R31	Oboe	0	0	0	0	101	101	
R32	Bassoon	0	0	0	0	107	107	
R33	English Horn	0	-	-	-	-	-	
R34	Wood Winds	0	-	-	-	-	-	
R41	Clarinet	0	0	0	0	102	102	
R42	Clarinet2	0	0	-	-	102a	-	
R43	Clarinet3	0	0	-	-	102b	-	
R44	Clarinet4	0	0	-	-	102c	-	
R45	Bs Clarinet	0	0	-	-	-	-	
R51	Shakuhachi	0	0	0	0	108	108	
R52	HumanWhistle	0	0	0	-	109	109	
R61	Bagpipe	0	-	-	-	-	-	
R62	Uilleann Pipe	0	-	-	-	-	-	
S11	Synth. Lead1	0	0	0	0	110	110	
S12	Synth. Lead2	0	0	0	0	111	111	
S13	Synth. Lead3	0	0	0	-	112	112	
S14	Synth. Lead4	0	0	0	-	113	113	
S15	Synth. Lead5	0	0	0	-	114	114	
S16	CC Solo	0	-	-	-	-	-	
T11	Organ Bass1	0	0	0	0	115	115	
T12	Organ Bass2	0	0	0	0	116	116	
T21	Pipe Org. Bs	0	0	0	0	117	117	
T22	Theater Bass	0	0	-	-	117a	-	
T23	Bombarde	0	0	-	-	-	-	
T31	String Bass	0	0	0	0	118	118	
T32	Bass+Cymbal	0	0	0	0	126	126	
T33	String Bass2	0	0	-	-	118a	-	
T41	Contrabass1	0	0	0	0	121	121	
T42	Contrabass2	0	0	0	-	122	122	
T51	E.Bass1	0	0	0	0	119	119	
T52	E.Bass2	0	0	0	0	120	120	
T53	E.Bass3	0	0	-	-	119a	-	
T54	E.Bass4	0	0	-	-	120a	-	
T61	Tuba	0	0	0	0	123	123	
T62	Tuba2	0	0	-	-	123a	-	
T71	Synth. Bass1	0	0	0	0	124	124	
T72	Synth. Bass2	0	0	0	-	125	125	
T81	Voice Thum	0	0	0	0	-	-	
U11	Org. Attack1	0	0	0	-	075	075	
U12	Org. Attack2	0	0	0	-	076	076	
U13	Org. Attack3	0	0	0	-	077	077	
U14	Org. Attack4	0	0	0	-	078	078	
U15	Org. Click	0	0	0	-	079	079	
V11	Timpani	0	0	0	-	127a	-	
V12	Timpani2	0	0	-	-	-	-	
V21	Ride Cymbal	0	0	-	-	126a	-	
V22	Crash Cymbal	0	0	-	-	126b	-	
V23	Tambourine	0	0	-	-	126c	-	
V24	Woodblock	0	0	-	-	126d	-	
V25	Jingle Bell	0	0	-	-	126e	-	
V26	Snare Drum	0	0	-	-	126f	-	
V27	Bass Drum	0	0	-	-	126g	-	
V28	Church Bell	0	-	-	-	-	-	
V31	Perc. Set1	0	0	0	-	127	127	
V32	Perc. Set2	0	0	0	-	128	128	
V33	Perc. Set3	0	0	-	-	128a	-	
V34	Orch.HitMenu	0	0	-	-	-	-	
V35	DanceHitMenu	0	-	-	-	-	-	

Rhythm List (AT-90R/80R/60R/30R/20R)

	90R	80R	60R	30R	20R
Fast BigBand	0	0	0	0	-
New Big Band	0	0	0	-	-
BigBandSwing	0	0	0	0	0
BigBndBallad	0	0	0	0	-
Jazz Band	0	0	0	-	-
Big Band	0	0	0	0	0
Big Band 2	0	0	0	-	-
Boogie	0	0	-	-	-
Blues	0	0	-	-	-
A Cappella	0	0	0	0	0
Combo	0	0	0	0	0
Club Swing	0	0	-	-	-
Medium Swing	0	0	0	-	-
Slow Swing	0	0	0	-	-
Vocal Swing	0	0	-	-	-
Swing	0	0	0	-	-
Shuffle	0	0	0	-	-
CountryRoads	0	0	0	-	-
CountryPiano	0	0	0	0	-
CtrySerenade	0	0	-	-	-
Western	0	-	-	-	-
CountrySwing	0	0	0	-	-
Hoedown	0	0	0	0	0
Twostep	0	0	0	-	-
CountryWaltz	0	0	0	0	0
Easy Country	0	0	0	0	0
Cajun	0	0	-	-	-
Beach Sound	0	0	0	-	-
Rock'n'Roll	0	0	0	-	-
Twist	0	0	0	0	0
50'sBallad	0	-	-	-	-
Slow Dance	0	0	0	0	0
Dreamin'	0	0	0	0	-
50's Pop 1	0	0	0	0	0
50's Pop 2	0	0	-	-	-
Love Romance	0	0	0	0	0
Torch Song	0	0	0	0	0
Torch Song 2	0	0	-	-	-
Love Songs	0	0	0	0	0
MediumBallad	0	0	0	-	-
Pop Ballad	0	0	-	-	-
Ballad	0	0	0	0	-
Classic	0	0	0	-	-
Dixieland	0	0	0	0	0
Polka	0	0	0	0	-
Foxtrot	0	0	0	-	-
Charleston	0	0	0	-	-
PianoBoogie1	0	0	0	-	-
PianoBoogie2	0	-	-	-	-
Rag Time	0	0	-	-	-

	90R	80R	60R	30R	20R
G.Pop	0	0	0	0	0
G.Fast Pop	0	0	0	0	-
P.Slow	0	0	0	0	0
P.Jazz	0	0	0	0	-
G.Slow	0	0	-	-	-
G.Shuffle	0	0	0	-	-
P.Night	0	0	0	0	0
P.Pop	0	0	-	-	-
P.Concerto	0	0	-	-	-
Hawaiian	0	0	0	0	0
French Waltz	0	0	0	-	-
D Marsch 6/8	0	0	0	-	-
Scotland	0	0	0	-	-
Ireland	0	0	0	-	-
Reggae	0	0	0	0	-
Habanera	0	0	-	-	-
Sevilla	0	0	-	-	-
Bossa Nova	0	0	0	0	0
Bossa Nova2	0	0	0	-	-
FastBosaNova	0	0	0	-	-
Slow Bossa	0	0	0	0	0
NewBossaNova	0	0	-	-	-
Chacha	0	0	0	0	-
Chacha 2	0	0	-	-	-
Salsa	0	0	0	0	0
Samba	0	0	-	-	-
Rhumba	0	0	0	0	0
Rhumba 2	0	-	-	-	-
Beguine	0	0	0	0	-
Mambo	0	0	0	0	0
Tango 1	0	0	0	0	0
Tango 2	0	0	0	-	-
Latin Fusion	0	0	-	-	-
Samba Rio	0	0	0	0	0
Screen 1	0	0	0	0	-
Screen 2	0	0	0	-	-
Music Hall	0	0	0	-	-
Broadway	0	0	0	0	-
ChooChooSwg	0	0	0	-	-
Bubbles	0	0	-	-	-
Balloon Trip	0	0	-	-	-
Raindrops	0	0	0	0	0
Festival	0	0	0	0	-
Little Steps	0	0	-	-	-
WesternMovie	0	-	-	-	-

	90R	80R	60R	30R	20R
8Beat Pop	0	0	0	-	-
Swing Pop	0	0	0	0	0
PopularPiano	0	0	0	0	-
Acoustic Pop	0	0	0	-	-
Pop'n Roll	0	0	-	-	-
Easy Listen1	0	0	0	0	0
Easy Listen2	0	0	0	0	0
Easy Listen3	0	0	-	-	-
Easy Listen4	0	0	-	-	-
Easy Listen5	0	-	-	-	-
Rollin'	0	0	0	-	-
16BeatShuffl	0	0	-	-	-
Motown	0	0	0	0	-
ShufflePop 1	0	0	0	-	-
ShufflePop 2	0	0	0	-	-
Rock'n'Shffl	0	0	-	-	-
Light Fusion	0	0	-	-	-
Rock'n Pop	0	0	0	-	-
Gospel Piano	0	-	-	-	-
Gospel Pop	0	0	0	0	-
GospelBallad	0	0	-	-	-
Gospel 1	0	0	0	-	-
Gospel 2	0	0	-	-	-
Anthem	0	0	0	0	-
Revival	0	0	0	-	-
Chapel	0	-	-	-	-
Last Dance	0	0	0	0	-
Jazz Waltz	0	0	0	-	-
StringsWaltz	0	0	0	-	-
Slow Waltz	0	0	0	0	0
Waltz	0	0	-	-	-
Musette	0	0	0	0	-
Vienna Waltz	0	0	-	-	-
March 4/4	0	0	0	0	0
March 6/8	0	0	0	0	0
March 2/4	0	0	-	-	-
Simple March	0	0	-	-	-
Cute Pop	0	0	0	-	-
R&B	0	0	-	-	-
Slow Rock	0	-	-	-	-
Rock'n'Roll2	0	0	-	-	-
60'sBallad	0	0	0	-	-
Crystal	0	0	-	-	-
Bossa Nova 3	0	0	0	-	-
Bossa Nova 4	0	0	0	-	-
Cinema	0	0	-	-	-
Entertaining	0	0	-	-	-
70's Disco	0	-	-	-	-
16Beat Pop 1	0	0	0	-	-
16Beat Pop 2	0	0	0	-	-
AcousticRock	0	0	-	-	-
Rock 1	0	-	-	-	-
Rock 2	0	-	-	-	-

Rhythm List

左ページ (P.8, 10) は AT-90/80/30, 右ページ (P.9, 11) は AT-90R/80R/60R/30R/20R のリズム一覧表です。

The lists on left pages (p.8, 10) are AT-90/80/30 Rhythm List.

The lists on right pages (p.9, 11) are AT-90R/80R/60R/30R/20R Rhythm List.

AT-90	AT-80	AT-80 for Japan	AT-30
Jazz Band	-	Jazz Band	Jazz Band
Big Band	-	-	Big Band
-	Big Band	Big Band	-
-	Blues	-	-
BigBndBallad	-	-	BigBndBallad
-	BigBndBallad	BigBndBallad	-
Boogie	-	Boogie	-
Standard	Standard	Standard	-
-	Vocal Swing	-	-
Combo	Combo	Combo	Combo
Medium Swing	-	Medium Swing	-
Shuffle	-	-	-
Swing	Swing	Swing	Swing
-	Club Piano	Club Piano	-
Cntry Ballad	Cntry Ballad	-	-
CountrySwing	CountrySwing	-	-
-	-	Two Step	Two Step
Bluegrass	Bluegrass	Bluegrass	-
-	-	-	Bluegrass
CountryWaltz	CntryWltz	-	CountryWaltz
-	Easy Country	-	-
Hoe Down	Hoe Down	-	-
New Country	-	New Country	-
-	-	Western	-
Two Step	Two Step	-	-
-	-	Country Rock	-
-	-	DancePop 1	-
-	-	DancePop 2	-
-	-	70's Disco	-
-	-	Light Fusion	-
-	-	Rock 1	-
-	-	Rock 2	-
-	50's Ballad	-	-
Slow Dance	Slow Dance	50'sBallad 1	-
50's	50's	-	-
-	-	-	Twist
Rock'n'Roll1	Rock'n'Roll	Rock'n'Roll1	Rock'n'Roll1
Rock'n'Roll2	-	Rock'n'Roll2	Rock'n'Roll2
-	-	R&B	-
-	-	AcousticRock	-
Love Songs	Love Songs	-	Love Songs
Ballad	Ballad	Ballad 1	Ballad
-	-	50'sBallad 2	-
-	-	16BeatBallad	-
Classic	Classic	-	Classic
-	Torch Song	-	-
-	Piano Boogie	-	-
-	-	Festival	-

※ Disk と書かれているのは、添付のミュージック・スタイル・ディスクのリズム番号です。
 ※ World と書かれているのは、添付のワールド・スタイル・セットアップ・ディスクのリズム番号です。

* Disk-**: Rhythm Number of Music Style Disk
 * World-**: Rhythm Number of World Style Setup Disk

AT-90R	AT-80R	AT-60R	AT-30R	AT-20R
Jazz Band	Jazz Band	Jazz Band	Disk-03	Disk-03
Big Band	Big Band	Big Band	Big Band	Big Band
Big Band2	Big Band2	Big Band2	-	-
Blues	Blues	-	-	-
Disk1-01	Disk1-01	Disk1-01	Disk-01	Disk-01
BigBndBallad	BigBndBallad	BigBndBallad	BigBndBallad	-
Boogie	Boogie	Disk1-05	-	-
Disk1-02	Disk1-02	Disk1-02	-	-
Vocal Swing	Vocal Swing	-	-	-
Combo	Combo	Combo	Combo	Combo
Disk1-07	Disk1-07	Disk1-07	Disk-08	Disk-08
Shuffle	Shuffle	Shuffle	-	-
Swing	Swing	Swing	Disk-07	Disk-07
Club Swing	Club Swing	-	-	-
Disk1-13	Disk1-13	Disk1-13	Disk-14	Disk-14
CountrySwing	CountrySwing	CountrySwing	Disk-15	Disk-15
Disk1-15	Disk1-15	Disk1-15	Disk-16	Disk-16
Disk1-10	Disk1-10	Disk1-10	Disk-10	Disk-10
Disk1-11	Disk1-11	Disk1-11	Disk-11	Disk-11
CountryWaltz	CountryWaltz	CountryWaltz	CountryWaltz	CountryWaltz
Easy Country	Easy Country	Easy Country	Easy Country	Easy Country
Hoedown	Hoedown	Hoedown	Hoedown	Hoedown
Cajun	Cajun	Disk2-01	Disk-12	Disk-12
Western	Disk2-02	Disk2-02	-	-
Twostep	Twostep	-	-	-
Disk2-02	Disk2-03	-	-	-
Disk2-32	Disk2-29	Disk2-14	-	-
Disk2-33	Disk2-30	Disk2-15	Disk-62	Disk-62
Disk2-31	Disk2-28	-	-	-
Light Fusion	Light Fusion	-	-	-
Rock 1	Disk2-24	Disk2-12	-	-
Rock 2	Disk2-25	Disk2-13	-	-
50'sBallad	Disk2-05	-	-	-
Slow Dance	Slow Dance	Slow Dance	Slow Dance	Slow Dance
50's Pop 1	50's Pop 1	50's Pop 1	50's Pop 1	50's Pop 1
Twist	Disk1-17	Disk1-17	Disk-18	Disk-18
Disk1-49	Disk1-49	Disk1-49	Disk-57	Disk-57
Disk1-50	Disk1-50	Disk1-50	Disk-58	Disk-58
R&B	R&B	-	-	-
AcousticRock	AcousticRock	-	-	-
Love Songs	Love Songs	Love Songs	Love Songs	Love Songs
Ballad	Ballad	Ballad	Ballad	-
Dreamin'	Dreamin'	Dreamin'	Dreamin'	-
Easy Listen5	Disk2-15	Disk2-06	Disk-42	Disk-42
Classic	Classic	Classic	Disk-21	Disk-21
Torch Song	Torch Song	Torch Song	Torch Song	Torch Song
PianoBoogie2	Disk2-06	-	-	-
Festival	Festival	Festival	-	-

AT-90	AT-80	AT-80 for Japan	AT-30
Foxtrot	Foxtrot	Foxtrot	Foxtrot
Dixieland	-	-	Dixieland
-	Dixieland	Dixieland	-
Charleston	Charleston	-	-
-	-	Reggae	-
-	-	Folk Dance	-
-	-	Kayou	-
Bossa Nova	Bossa Nova	-	-
-	-	Bossa Nova	Bossa Nova
Fast Bossa	-	FastBosaNova	-
Chacha	Chacha	Chacha	Chacha
Mambo	-	Mambo	Mambo
-	-	Salsa	-
Samba	Samba	Samba	-
Rhumba	Rhumba	Rhumba	Rhumba
-	-	-	Samba
Beguine	-	Beguine	Beguine
-	Beguine	-	-
Tango	Tango	-	-
-	-	Tango 1	-
-	-	Tango 2	-
-	-	-	Tango
-	-	Latin Fusion	-
-	ChooChooSwg	-	-
Music Hall	Music Hall	Music Hall	-
Broadway	-	-	-
Bubbles	Bubbles	-	-
-	-	Pop 1	-
-	-	Pop 2	-
-	-	Pop 3	-
-	-	Pop 4	-
-	-	Simple 8Beat	-
-	-	Contemporary	-
Easy Listen1	Easy Listen1	-	-
Easy Listen2	Easy Listen2	-	Easy Listen1
PopularPiano	PopularPiano	-	PopularPiano
Pop	-	ShufflePop 1	Pop
-	-	ShufflePop 2	-
-	-	Rock'n'Shfl	-
-	-	16Bt Shuffle	-
-	-	-	Easy Listen2
Gospel	Gospel	Gospel 1	-
-	-	Gospel 2	-
Revival	Revival	New Gospel	-
Anthem	Anthem	Slow Gospel	-
GospelBallad	-	GospelBallad	-
March 4/4	March 4/4	March 4/4	March 4/4
March 6/8	March 6/8	March 6/8	March 6/8
-	German March	March 2/4	-
-	-	Simple March	-
Slow Waltz	Slow Waltz	Slow Waltz	Slow Waltz
Slow Waltz 2	-	-	-
Musette	Musette	Musette	Musette
Vienna Waltz	Vienna Waltz	Vienna Waltz	Vienna Waltz
-	Waltz	Waltz	-
Hawaiian	Hawaiian	Hawaiian	Hawaiian
Polka	Polka	Polka	Polka

AT-90R	AT-80R	AT-60R	AT-30R	AT-20R
Foxtrot	Foxtrot	Foxtrot	Disk-24	Disk-24
Disk1-22	Disk1-22	Disk1-22	Disk-23	Disk-23
Dixieland	Dixieland	Dixieland	Dixieland	Dixieland
Charleston	Charleston	Charleston	Disk-22	Disk-22
Disk2-5	Disk2-7	-	-	-
Disk2-25	Disk2-21	-	-	-
World-33	World-33	World-33	World-33	-
Bossa Nova2	Bossa Nova2	Bossa Nova2	Disk-31	Disk-31
Disk1-29	Disk1-29	Disk1-29	Disk-33	Disk-33
FastBosaNova	FastBosaNova	FastBosaNova	Disk-32	Disk-32
Chacha	Chacha	Chacha	Chacha	-
Disk1-32	Disk1-32	Disk1-32	Disk-36	Disk-36
Salsa	Salsa	Salsa	Salsa	Salsa
Samba Rio	Samba Rio	Samba Rio	Samba Rio	Samba Rio
Rhumba	Rhumba	Rhumba	Rhumba	Rhumba
Disk1-33	Disk1-33	Disk1-33	Disk-37	Disk-37
Disk1-36	Disk1-36	Disk1-36	Disk-39	Disk-39
Beguine	Beguine	Beguine	Beguine	-
Disk1-34	Disk1-34	Disk1-34	-	-
Tango 1	Tango 1	Tango 1	Tango 1	Tango 1
Disk2-11	Disk2-10	-	-	-
Disk1-35	Disk1-35	Disk1-35	Disk-38	Disk-38
Latin Fusion	Latin Fusion	-	-	-
ChooChooSwg	ChooChooSwg	ChooChooSwg	-	-
Music Hall	Music Hall	Music Hall	-	-
Broadway	Broadway	Broadway	Broadway	-
Bubbles	Bubbles	-	-	-
Disk2-13	Disk2-11	-	-	-
Disk1-41	Disk1-41	Disk1-41	Disk-45	Disk-45
Disk2-14	Disk2-12	-	-	-
Disk2-15	Disk2-13	-	-	-
Disk2-16	Disk2-14	-	-	-
Disk1-52	Disk1-52	Disk1-52	Disk-59	Disk-59
Easy Listen1	Easy Listen1	Easy Listen1	Easy Listen1	Easy Listen1
Easy Listen2	Easy Listen2	Easy Listen2	Easy Listen2	Easy Listen2
PopularPiano	PopularPiano	PopularPiano	PopularPiano	-
ShufflePop 1	ShufflePop 1	ShufflePop 1	Disk-46	Disk-46
ShufflePop 2	ShufflePop 2	ShufflePop 2	-	-
Rock'n'Shffl	Rock'n'Shffl	-	-	-
Disk2-21	Disk2-17	-	-	-
Easy Listen3	Easy Listen3	Disk2-04	Disk-40	Disk-40
Gospel 1	Gospel 1	Gospel 1	-	-
Gospel 2	Gospel 2	Disk2-07	Disk-47	Disk-47
Revival	Revival	Revival	-	-
Anthem	Anthem	Anthem	Anthem	-
GospelBallad	GospelBallad	Disk2-08	Disk-48	Disk-48
March 4/4	March 4/4	March 4/4	March 4/4	March 4/4
March 6/8	March 6/8	March 6/8	March 6/8	March 6/8
March 2/4	March 2/4	Disk2-10	Disk-54	Disk-54
Simple March	Simple March	-	-	-
Slow Waltz	Slow Waltz	Slow Waltz	Slow Waltz	Slow Waltz
Disk1-43	Disk1-43	Disk1-43	Disk-52	Disk-52
Musette	Musette	Musette	Musette	-
Vienna Waltz	Vienna Waltz	Disk2-09	Disk-50	Disk-50
Waltz	Waltz	-	-	-
Hawaiian	Hawaiian	Hawaiian	Hawaiian	Hawaiian
Polka	Polka	Polka	Polka	-

■ **Rhythm List**

AT-90R/AT-80R

USA	UK	Germany	France	Japan
BigSerenade	Scotland 6/8	German Waltz	Paris Waltz	Mood Kayou
Tejano	Organ Swing	Deutsch-Pop	Paris March	TasogareTown
Country Folk	Disco People	Polonaise	ChansonTango	Enka 1
Country Rock	70's 8beat	Ballade 6/8	Java	Enka 2
CountryBlues	BigSerenade	Disco-Beat	French Pop 1	16Beat Pop
Rock'n'Night	Fast Waltz	Party-Beat	French Pop 2	Power 8Beat
StridePiano	12/8 Ballad	Dt'Halfbeat	French Pop 3	AshitaNoHero
PianoBallad	Easy Swing	Evergreen	Paso Doble	Group Sounds

AT-60R

USA	UK	Germany	France	Japan
BigSerenade	Scotland 6/8	German Waltz	Paris Waltz	Mood Kayou
Tejano	Organ Swing	Deutsch-Pop	Paris March	TasogareTown
Country Folk	Disco People	Polonaise	ChansonTango	Enka 1
Country Rock	70's 8beat	Ballade 6/8	Java	Enka 2
CountryBlues	BigSerenade	Disco-Beat	French Pop 1	16Beat Pop
PianoBallad	Fast Waltz	Party-Beat	French Pop 2	Power 8Beat

AT-30R

USA	UK	Germany	France	Japan
Country Folk	Scotland 6/8	German Waltz	Paris Waltz	Enka 1
Country Rock	Organ Swing	Deutsch-Pop	ChansonTango	16Beat Pop

■ **Rhythm List** (The list when you use the World Style Setup Disk as a Music Style Disk)

No.	Name	No.	Name	No.	Name
01	Tejano	15	12/8 Ballad	29	French Pop 1
02	Country Folk	16	Easy Swing	30	French Pop 2
03	Country Rock	17	German Waltz	31	French Pop 3
04	CountryBlues	18	Deutsch-Pop	32	Paso Doble
05	Rock'n'Night	19	Polonaise	33	Mood Kayou
06	StridePiano	20	Ballade 6/8	34	TasogareTown
07	PianoBallad	21	Disco-Beat	35	Enka 1
08	SFX Movie	22	Party-Beat	36	Enka 2
09	Scotland 6/8	23	Dt'Halfbeat	37	16Beat Pop
10	Organ Swing	24	Evergreen	38	Power 8Beat
11	Disco People	25	Paris Waltz	39	AshitaNoHero
12	70's 8beat	26	Paris March	40	Group Sounds
13	BigSerenade	27	ChansonTango		
14	Fast Waltz	28	Java		

World Style Setup Disk

The Rhythm [World] button of this instrument contains some preset Rhythms, but by using the included World Style Setup Disk, you can rewrite these to the Rhythms of the desired country.

Loading Disk Rhythms into the Rhythm [World] Button

1. Make sure that a floppy disk is not inserted in the disk drive.
2. Press the [Power] switch to turn off the power.
3. Hold down the Rhythm [World] button, and press the [Power] button to turn on the power. The following screen will appear.

```
Insert WorldDisk
or Press[World]
```

4. Insert the World Style Setup Disk into the disk drive. After a few second, the following screen will appear.

```
Select Country
USA +/-/World
```

5. Use the Rhythm Select [+] [-] to select the country of the Rhythms that you wish to store in the [World] button.

The following countries can be selected:
USA, UK, Germany, France, Japan

6. When you have selected the county of the Rhythm, press the [World] button. The following screen will appear.

```
Set to USA?
OK:World No:Exit
```

7. Press the Rhythm [World] button again to start loading the Rhythm into the internal memory.

* Never remove the disk or turn off the power while the Rhythm data is being loaded from disk into this instrument.

```
Setting...
Don't Power OFF
```

Once the Rhythm has been accommodated in memory, the basic screen will reappear.

* The World Style Setup Disk can also be used as a Music Style Disk.

* The number of Rhythms that can be loaded into internal memory will depend on the model. For the Rhythm list, refer to the other side of the page.

Restoring the Rhythm Stored in the [World] Button to the Factory Settings

1. Make sure that a floppy disk is not inserted in the disk drive.
2. Press the [Power] switch to turn off the power.
3. Hold down the Rhythm [World] button, and press the [Power] button to turn on the power. The following screen will appear.

```
Insert WorldDisk
or Press[World]
```

4. Press the Rhythm [World] button.

```
Preset World?
OK:World No:Exit
```

5. Press the Rhythm [World] button once more.

When the following screen has been appeared, the basic screen will reappear.

* Never turn off the power, while the basic screen is NOT appeared.

```
Presetting...
Don't Power OFF
```

Errata

We apologize for the following errors in the Owner's Manual for AT-60R/AT80R. Please make the appropriate corrections.

● **(AT-60R/AT-80R) Page 50 "Harmony Intelligence"**

The following caution should be added:

If you select the Harp type of Harmony Intelligence, no sound is produced simply by pressing a key. While pressing chords on Lower keyboard with the left hand, play the Upper keyboard with the right hand, using a Glissando technique. You can easily simulate the beautiful sonorities of a harp.

● **(AT-60R/AT-80R) Page 108 Chart "Glide" menu**

The following sentences should be added:

When the power is turned on, Glide effect is added to the voice of all the sections being played on Upper keyboard (p.109).

● **(AT-60R) Page 121, 122 "Voice List"**

*2: Vibrato: effective, Aftertouch: effective → ***2: Vibrato: effective**

* Aftertouch has no effect on the AT-60R.

● **(AT-60R/AT-80R) Page 158 Main Specifications "Connectors"**

Pedal Jack ← **delete**

* The AT-60R has no pedal jack.

お詫びと訂正

取扱説明書の一部に誤りがありました。謹んでお詫びを申し上げますとともに、次のように訂正いたします。

● (AT-60R) P.47 メモ

[Disk] ボタン以外の設定を製品出荷時の設定に戻すときには、ファクトリー・リセット (P.19) してください。



[Disk] ボタン以外の設定を製品出荷時の設定に戻すときには、ファクトリー・リセット (P.18) してください。

● (AT-60R / AT-80R) P.49 以下の注意文追加

ハーブ・タイプのハーモニー・インテリジェンスは弾いた鍵は発音しません。左手を使ってローワー鍵盤でコードを弾きながら、右手でアッパー鍵盤をグリッサンドすると、美しいハーブの響きを表現できます。

● (AT-60R / AT-80R) P.107 「フット・スイッチの機能を切り替える」の表「Glide」の項目に以下の文章追加

電源投入時には、アッパー鍵盤で弾いた音に効果が得られます (P.108)。

● (AT-60R) P.120、P.121 ボイス一覧

*2: ビブラート効果 / アフタータッチ → *2: ビブラート効果

※ AT-60R にはアフタータッチはかかりません。

● (AT-60R / AT-80R) P.154 MIDI インプリメンテーション・チャート

	ファンクション...	送 信	受 信	備 考
誤	コントロール チェンジ 11	○	○ *3	<u>エクスプレッション (LSB)</u>



正	コントロール チェンジ 11	○	○ *3	<u>エクスプレッション (MSB)</u>
---	-------------------	---	------	------------------------

● (AT-60R / AT-80R) P.157 主な仕様「接続端子」

ペダル端子 → 削除 ※ペダル端子はありません。

● (AT-60R) P.157 主な仕様

消費電力 125W → 152W

■ ベーシック・ガイドについてのご注意

● P.15 マニュアル・パーカッション (Manual Percussion) について

AT-60R では、ローワー鍵盤の E2 (下から 5 鍵目) から F#3 までの 15 鍵でマニュアル・パーカッションになります。 ※下から 4 鍵 (C2 ~ D#2) では、音が鳴りません。



This product complies with the requirements of European Directives EMC 89/336/EEC and LVD 73/23/EEC.

For EU Countries

FEDERAL COMMUNICATIONS COMMISSION RADIO FREQUENCY INTERFERENCE STATEMENT

This equipment has been tested and found to comply with the limits for a Class B digital device, pursuant to Part 15 of the FCC Rules. These limits are designed to provide reasonable protection against harmful interference in a residential installation. This equipment generates, uses, and can radiate radio frequency energy and, if not installed and used in accordance with the instructions, may cause harmful interference to radio communications. However, there is no guarantee that interference will not occur in a particular installation. If this equipment does cause harmful interference to radio or television reception, which can be determined by turning the equipment off and on, the user is encouraged to try to correct the interference by one or more of the following measures:

- Reorient or relocate the receiving antenna.
- Increase the separation between the equipment and receiver.
- Connect the equipment into an outlet on a circuit different from that to which the receiver is connected.
- Consult the dealer or an experienced radio/TV technician for help.

Unauthorized changes or modification to this system can void the users authority to operate this equipment.
This equipment requires shielded interface cables in order to meet FCC class B Limit.

For the USA

NOTICE

This Class B digital apparatus meets all requirements of the Canadian Interference-Causing Equipment Regulations.

AVIS

Cet appareil numérique de la classe B respecte toutes les exigences du Règlement sur le matériel brouilleur du Canada.

For Canada

Roland®

71348401

UPC

71348401



18901