

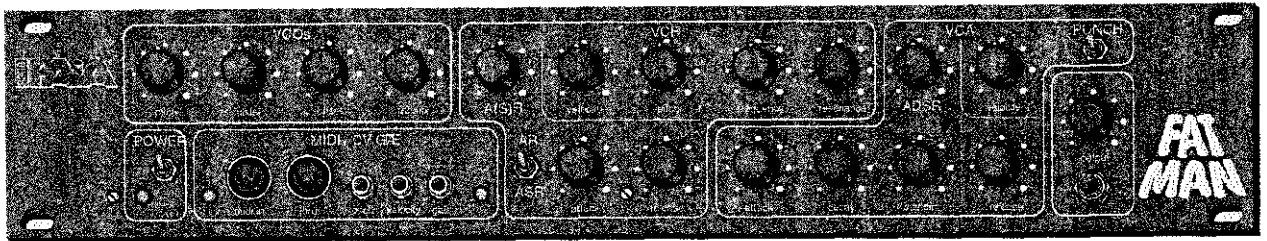

FatMan Analog MIDI Synth

Model 9308
Assembly and Using Manual



It's hard to beat analog synths for fat, punchy bass lines. And for discovering new sounds, nothing comes close to real knobs operating in real time. The FatMan has all of the features that give analog it's warm, full tone in a MIDI controlled package. The classic normalization scheme of twin VCO/VCF/VCA and Dual Transient Generators is brought up to date with the inclusion of Velocity CV not available on pre-MIDI synths.

FatMan learns from the past by including features that were eccentricities of classic synths such as a unique "punch" switch that adds a subtle but useful fifth segment to the standard ADSR response.

Details specific to the installation of the FatMan circuit board in the 9308C Desk Top enclosure are covered in the 9308C Supplement. Follow the assembly instructions in this manual until instructed to reference the 9308C Supplement.

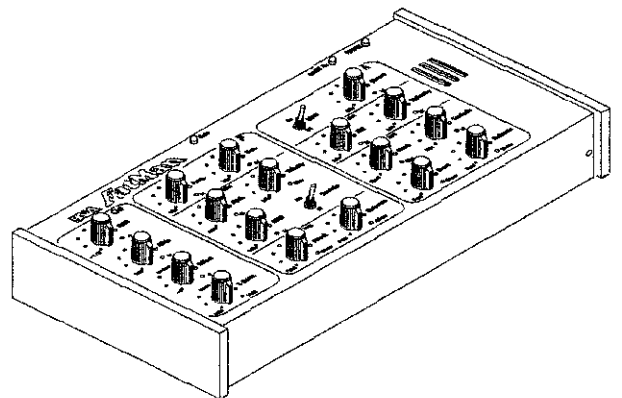

-- See Errata on inside back cover.

ASSEMBLING THE FatMan MIDI Synth

Before beginning assembly, go through the manual. Look at the drawings. Feel the parts. You're naturally eager to plunge right in, but take a few deep breaths first. Check the parts supplied against the packing list on the last page of this manual.

In some cases, notes packed with the parts will be used to call your attention to special situations. These notes may be in the "MISSING PARTS" postcard. If parts are missing please notify PAiA at phn 405.340.6300, fax 340.6378, or info@paia.com .

Notice that each step in the manual is marked with a checkoff box like this:

DESIGNATION	VALUE	COLOR CODE
() R27	100 ohm	brown-black-brown

Checking off each step as you do it may seem silly and ritualistic, but it greatly decreases the chance of omitting a step and also provides some gratification and reward as each step is completed.

Numbered figures are printed in the Illustrations Supplement in the center of this manual. These pages may be removed for easy reference during assembly.

THE CIRCUIT BOARD

The FatMan is built on a single-sided circuit board. The solder side of the board is soldered masked with a conformal coating and conductors are tin-lead plated for ease of soldering and assembly. No cleaning of the circuit board or other special preparation is necessary before beginning assembly.

TOOLS

You'll need a minimum of tools to assemble the kit - a small pair of diagonal wire cutters and pliers, screwdriver, sharp knife, ruler, soldering iron and solder.

Modern electronic components are small (in case you hadn't noticed) and values marked on the part are often difficult to see. Another handy tool for your bench will be a good magnifying glass. Also use the magnifier to examine each solder joint as it is made to make sure that it doesn't have any of the problems described in the SOLDERING section which follows.

CAUTION-SMALL WIRE

Use particular care when stripping the # 26 insulated wire supplied for panel wiring. A low-cost wire stripping tool available from any electronics supply store is a good investment and can be set so that only the insulation is stripped away without nicking and weakening the wire strands. When instructed to "tin" the end of a wire, make sure the solder wicks into the entire length of the exposed wire strands - don't just put a blob of solder on the end.

SOLDERING

Select a soldering iron with a small tip and a power rating not more than 35 watts. Soldering guns are completely unacceptable for assembling solid state equipment because the large magnetic field they generate can damage components.

Use only rosin core solder (acid core solder is for plumbing, not electronics work). A proper solder joint has just enough solder to cover the soldering pad and about 1/16-inch of lead passing through it. There are two improper connections to beware of. Using too little solder will sometimes result in a connection which appears to be soldered when actually there is a layer of flux insulating the component lead from the solder bead. This situation can be cured by reheating the joint and applying more solder. If too much solder is used on a joint there is the danger that a conducting bridge of excess solder will flow between adjacent circuit board conductors forming a short circuit. Accidental bridges can be cleaned off by holding the board upside down and flowing the excess solder off onto a clean, hot soldering iron.

Use care when mounting all components. Never force a component into place.

CREDITS:

Bits: Kent Clark
Timbre and Dynamics: Jules Ryckebush
Pitches and Transients: John Simonton

Very special thanks to Scott Lee for making sure it all worked, frequently fixing it when it didn't and making as sure as humanly possible that there's a dot over every i and a cross for every t.

PAiA Electronics, Inc. disclaims any association with Mr. George Sanger a/k/a The Fat Man® and The Fat Man® - Interactive Sound Design services and products. PAiA Electronics FatMan MIDI Controlled Analog Synthesizer™ is neither sponsored nor approved by The Fat Man® or any entity with which he is affiliated.

Wire Jumpers

Assembly begins by forming and installing the forty three wire jumpers indicated by bold lines on the circuit board parts placement designators and numbered in the illustration to the right. For each jumper, cut a length of the bare wire supplied by measuring it against the distance between the circuit board holes and adding about 1/2". Bend 1/4" of each end down and push through the circuit board holes. Press the jumper fully against the board and solder both ends. Trim off excess wire flush with the solder joint.

Notice that five of the jumpers will be covered with the insulating sleeving supplied. Cut a piece of sleeving slightly shorter than the distance between the holes and slip it over the jumper before bending the wire ends down and placing.

() As outlined above, form and install the 43 wire jumpers used on the circuit board.

Resistors

Solder each resistor in place following the parts placement designators printed on the circuit board and the assembly drawing fig 1. Note that resistors are nonpolarized and may be mounted with either lead in either of the holes in the board. Before mounting each resistor, bend its leads so that they are at a right angle to the body of the part. Put the leads through the holes and then push the resistor firmly into place. Cinch the resistor in place by bending the leads on the solder side of the board out to an angle of about 45 degrees. Solder both ends of each resistor in place as you install it. Clip each lead flush with the solder joint as the joint is made. Save a dozen or so of the longer lead clippings for use as jumpers in later steps.

A tip: If you can't find the location for a resistor, go on to the next one and come back. DO NOT CHECK OFF A PART UNTIL IT IS INSTALLED AND SOLDERED.

DESIGNATION	VALUE	COLOR CODE A-B-C
-------------	-------	------------------

<i>listed below:</i>	4700 ohm	yellow-violet-red
----------------------	----------	-------------------

() R1	() R12	() R15	() R27
() R28	() R61	() R65	() R88
() R97	() R112		

() R2	220 ohm	red-red-brown
() R3	270 ohm	red-violet-brown
() R4	220 ohm	red-red-brown
() R5	220 ohm	red-red-brown

<i>listed below:</i>	10k	brown-black-orange
----------------------	-----	--------------------

() R6	() R7	() R8	() R9
() R29	() R30	() R46	() R55
() R67	() R76	() R77	() R79
() R86	() R101	() R106	

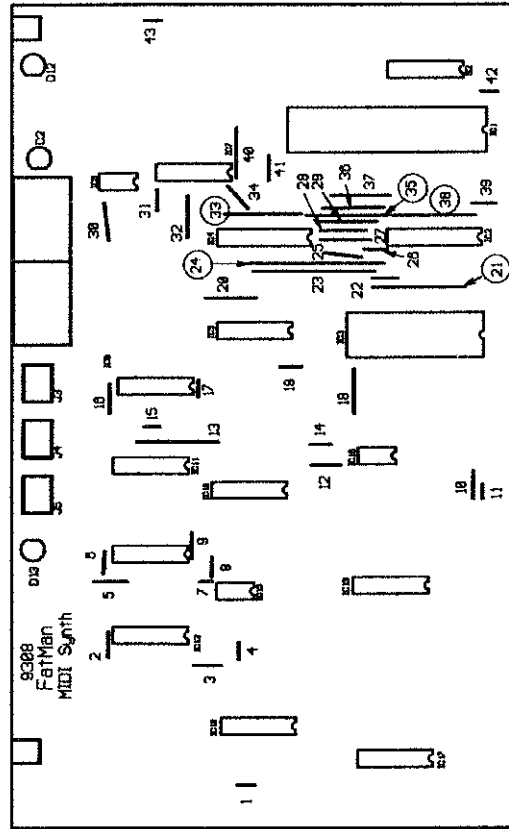

(X) Sleeving on these
43 Jumpers

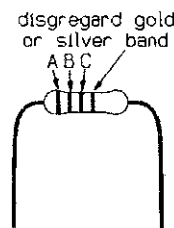

DESIGNATION	VALUE	COLOR CODE A-B-C	
() R10	2700 ohm	red-violet-red	
() R11	6800 ohm	blue-grey-red	
<i>listed below:</i>	1000 ohm	brown-black-red	
() R31	() R35	() R37	() R48
() R59	() R60	() R63	() R64
() R80			
<i>listed below:</i>	12k	brown-red-orange	
() R70	() R72	() R75	() R78
() R108			
<i>listed below:</i>	22k	red-red-orange	
() R36	() R66	() R68	() R107
<i>listed below:</i>	100 ohm	brown-black-brown	
() R16	() R20	() R26	() R44
() R53	() R81	() R83	() R91
() R95			
() R14	15k	brown-green-orange	
() R17	390 ohm	orange-white-brown	
() R19	270 ohm	red-violet-brown	
() R22	120 ohm	brown-red-brown	
() R23	47 ohm	yellow-violet-black	
() R25	56 ohm	green-blue-black	
<i>listed below:</i>	33k	orange-orange-orange	
() R45	() R54	() R109	
() R38	10 ohm	brown-black-black	
() R39	10 ohm	brown-black-black	
() R41	10 megohm	brown-black-blue	
() R43	47 ohm	yellow-violet-black	
() R47	56k	green-blue-orange	
<i>listed below:</i>	2200 ohm	red-red-red	
() R49	() R85	() R116	() R119
() R52	47 ohm	yellow-violet-black	
() R58	15k	brown-green-orange	
() R57	100k	brown-black-yellow	
() R62	15k	brown-green-orange	
() R89	18k	brown-grey-orange	
() R93	10 ohm	brown-black-black	
() R98	330k	orange-orange-yellow	
() R99	330k	orange-orange-yellow	
() R100	10 megohm	brown-black-blue	
() R103	39k	orange-white-orange	
() R105	39k	orange-white-orange	
() R110	470 ohm	yellow-violet-brown	
() R111	470 ohm	yellow-violet-brown	

The final resistor to be mounted on the circuit board is in fact two parts. Locate the two 15 ohm (brown-green-black) 1W resistors. These are roughly twice the size of the 1/4W resistors used in the previous steps. Cut the leads of these parts to a length of 1" and twist and solder one lead of each together before folding the resistors side by side as shown in the illustration. Install by pushing the two leads of the composite part through the holes in the circuit board. These parts will get very warm during operation. For better air flow and cooling **DO NOT** seat them flush with the board; instead, allow them to stand clear of the board by about 1/4". Solder in place and clip the leads off flush with the solder joint.



Twist leads together and solder. Fold parts side-by-side.

() R117 30 ohm 2W. as detailed above.

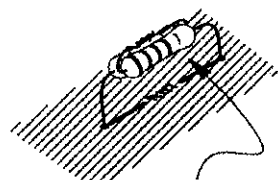

Allow about 1/4" of space between parts and circuit board.

Disk, Mylar and Polystyrene Capacitors

Many of the capacitors used in the FatMan are nonpolarized Ceramic Disk, Mylar and Polystyrene types. For all of these, either lead can go in either of the holes in the circuit board. The leads of the Ceramic Disk and Mylar capacitors are already parallel to each other but still may need to be bent slightly to match the spacing of the circuit board holes. The leads of the Polystyrene capacitors will need to bend down prior to installation and may be further apart than the spacing of the circuit board holes. Like the resistors, insert the leads of these parts through the holes in the board and push the part against the circuit board as far as it wants to go. Don't force it, it's OK if it sits a little off the board. Solder each capacitor in place as it is installed and clip the excess leads off flush with the solder joint.

Capacitors are often marked with obscure codes that indicate their values. The 3 digit number that specifies value may be preceded or followed by letters indicating such things as tolerance. If you get confused about which capacitors are which, it may help to group them by same type and check them against quantities on the packing list on page 3.

Capacitors

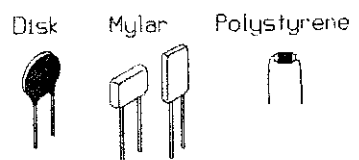

Ceramic Disks

DESIGNATION	VALUE	MARKING
() C2	33pF	33
() C3	33pF	33
<i>listed below:</i>	.01uF	103
() C4	() C9	() C10 () C11
() C13	() C16	
() C24	.001uF	102
<i>listed below:</i>	.047 uF	473 (may be .05uF - 503
() C34	() C35	() C36

Polystyrene and Mylar

() C20	560pF poly	560
() C21	560pF poly	560
() C7	.1 uF mylar	104
() C8	.1 uF mylar	104
() C12	.1uF mylar	104
() C14	.01 uF mylar	103
() C17	.01 uF mylar	103

Electrolytic Capacitors

The remaining capacitors are electrolytic types. Unlike the previous components, electrolytic capacitors are polarized and the leads are not interchangeable. Leads are marked "+" and/or "-" and the "+" lead must go through the "+" hole in the circuit board. Frequently the positive lead of the capacitor is significantly longer than the negative lead.

Usually the Negative lead of the capacitor is marked rather than the positive. It naturally goes through the unmarked hole. Solder each capacitor in place as it is installed and clip both leads off flush with the solder joint.

Capacitors supplied with specific kits may have a higher Voltage (V) rating than the minimum specified below.

DESIGNATION VALUE

() C1 10uF / 16V

listed below: 2.2uF / 16V

() C5 () C6 () C19 () C22
() C25

listed below: 1uF / 16V

() C15 () C18 () C31 () C32
() C33

() C23 10uF / 16V
() C26 470uF / 25V
() C27 470uF / 25V
() C28 100uF / 16V
() C29 100uF / 16V
() C30 100uF / 16V

Diodes

Two types of diodes are used in the FatMan, eight 1N4148 silicon signal diodes in small transparent glass cases and two 1N400x power diodes in larger opaque cases.

Like the Electrolytic Capacitors, diodes are polarized and must be installed so that the lead on the banded end of the part corresponds to the banded end of the designator on the circuit board. Bend the leads so they are at right angles to the body of the part and insert them through the holes provided in the circuit board.

Diodes are also somewhat heat sensitive so the soldering operation should be done as quickly as possible.

DESIGNATION VALUE

listed below: 1N4148 or 1N914 Silicon Signal Diodes

() D1 () D3 () D4 () D5
() D6 () D7 () D8 () D9

() D10 1N400x (may be 4001, 4002 or 4003)
() D11 1N400x

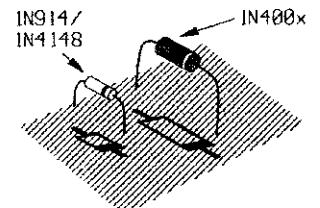
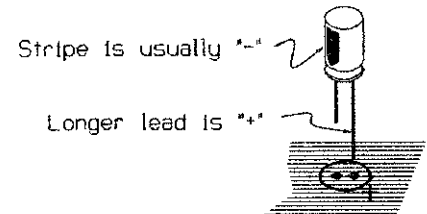

The polarizing color band corresponds to the filled end of the circuit board graphic.

Transistors

Install the transistors by inserting their three leads through the holes provided for them in the circuit board. Note that the transistors are polarized by the flat side of the case. When the transistors are properly installed this flat will align with the corresponding mark on the circuit board legending. Solder each transistor in place as it is installed and clip the excess leads off flush with the solder joint.

Notice that two different types of transistors are used. The type will be printed on the body of the part.

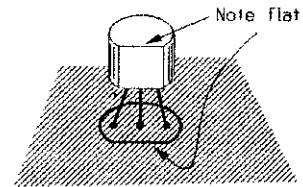

The straight line of the pc graphic symbol corresponds to the flat face of the transistor case.

DESIGNATION TYPE

listed below: 2N4124 NPN Silicon Transistor

() Q1 () Q2 () Q7 () Q10
() Q11

listed below: 2N4126 PNP Silicon Transistor

() Q3 () Q4 () Q5 () Q6
() Q8 () Q9 () Q12

Trimmer Potentiometers

Mount the five trimmer potentiometers by inserting their three pins into the holes provided. Press them down until the "shoulders" of the solder pins are resting on the surface of the circuit board. After making sure that the trimmers do not touch each other, solder all three pins on each part.

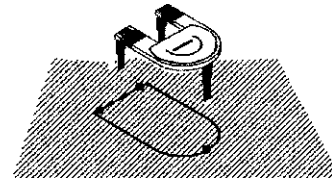

DESIGNATION VALUE

() R13 10k Trimmer Pot. *May be marked "103"*
() R42 10k " "
() R18 1k Trimmer Pot.
() R21 1k " "
() R24 1k " "

DIN Sockets

The 5-pin DIN sockets that are the MIDI connectors mount on the circuit board. Push the seven pins of each connector through the holes provided in the circuit board and make sure it is pushed down fully against the board before soldering in place.

DESIGNATION TYPE

() J1 MIDI Jacks
() J2 MIDI Jacks

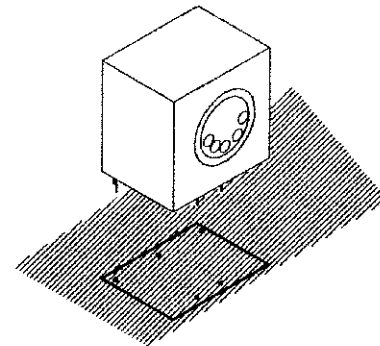

PC Mount Phono Jacks

The three Phono Jacks that are outputs for CVs and Trigger mount to the circuit board by pushing their three mounting tabs and the smaller center conductor through the holes in the board. On the trace side of the board, bend the tabs inward slightly to cinch the connector in place before soldering the smaller center conductor and mounting tab closest to the board edge. The mounting tabs on the side of the connectors need not be soldered.

DESIGNATION TYPE

- () J3 PC Mount Phono Jack
- () J4 PC Mount Phono Jack
- () J5 PC Mount Phono Jack

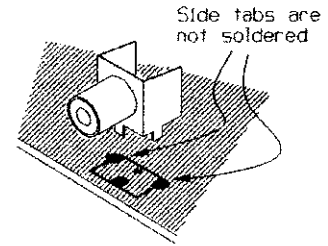

IC Sockets

Sockets are notorious for being the weak links in the chain of connections between electronic components. We use them only in places where their advantages outweigh their lack of reliability. The PROM is socketed so that it can be easily changed for upgrades. The 8031 uP is socketed for peace of mind - so that if trouble shooting is needed it can be easily removed and/or replaced. Less expensive "glue" logic is soldered directly to the board.

Sockets are polarized with a rectangular or semi-circular notch at one end of the part which corresponds to a similar indicator on the circuit board graphics. The socket would work just as well if it were inserted backward to the marked polarity, but this would surely generate confusion when the time came to install or replace the ICs.

Insert the socket in the circuit board holes and initially solder two pins in diagonal corners of the pattern. Make sure that the socket is seated firmly against the pc board by pressing it down while remelting the solder joint at first one corner, then the other. Finally, solder the remaining connections.

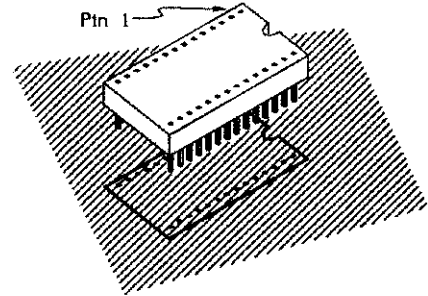

DESIGNATION SOCKET TYPE

- () IC1 40 pin
- () IC3 28 pin

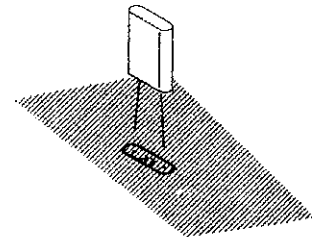

CRYSTAL - X1

- () Locate the 12 mHz. crystal. This part is nonpolarized and is installed at the location marked X1 on the circuit board (between C2 and C3.) Insert the leads through the holes in the circuit board, solder both leads and clip the excess off flush with the solder joint.

DIP Switch

In both of these examples all switches are off.

DEFAULT DIP SWITCH - S2

Locate the 8 position DIP Switch. Notice that the switch is polarized by the numbering of the individual switches (1-8) which will be printed on the package. Make sure that the DIP package is mounted so that the switch actuator labeled as "1" is on the end of the package closest to the edge of the circuit board. If there is a piece of tape protecting the switch bats, peel it off after installing the part.

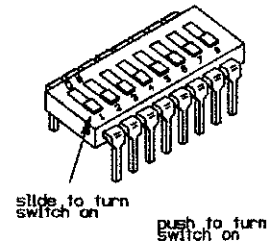

When assembling a FatMan board for Desk Case enclosure the switch mounts on the bottom (solder side) of the board as detailed in the 9308C Supplement.

When the FatMan circuit board is mounted behind a rack panel the DIP switch mounts on the component side of the board using the following step.

- () Install the 8-position DIP switch by soldering pins in diagonal corners of the pattern. Check to make sure that switch section #1 is closest to the edge of the circuit board and the package is firmly seated against the board before soldering the remaining pins.

Integrated Circuits

Of all the parts, the ICs are the most easily damaged and should be treated with some respect. In particular, they may be destroyed by discharges of static electricity. Modern ICs are not nearly as sensitive to this kind of damage as were earlier versions, but it is still good practice to handle these parts as little as possible. Also good practice: don't wear nylon during assembly. Don't shuffle around on the carpet immediately before assembly (or if you do, touch a lamp or something to make sure you're discharged). Don't be intimidated. It's rare for parts to be damaged this way.

ICs are polarized in one or both of two ways; A dot formed into the case of the IC corresponding to pin 1 or a semicircular notch that indicates the end of the package with pin 1. Take care that this polarizing indicator corresponds to the similar indicator on the circuit board graphics.

The pins of the ICs may be played somewhat and not match the holes in the circuit board exactly. Carefully re-form the leads if necessary so that they are at right angles to the part. Using the same procedure as with the sockets and DIP switch S2, solder each IC in place as it is installed.

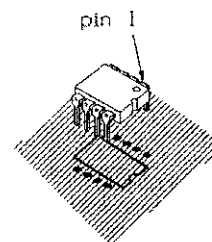

DESIGNATION	PART NO.	DESCRIPTION
() IC2	74HC373	8 Bit Latch
() IC4	74HC373	"
() IC5	DAC08	8 Bit DAC (may be 1408)
() IC6	6N138	Opto Isolator
() IC7	74HC14	Hex Inverting Schmitt Trig.
() IC8	LM339	Quad Comparator
() IC9	4052	Dual 1/4 CMOS MUX
() IC10	LM324	Quad OpAmp
() IC11	4016	Quad Analog Switch
() IC12	TL084	Quad Bi-fet OpAmp
() IC13	LM324	Quad OpAmp
() IC15	555	Timer
() IC16	555	"
() IC17	LM13600	Dual OTA (may be 13700)
() IC18	LM13600	"



555
6N138



74HC14
LM339
LM324
4016
TL084

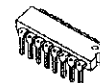

DAC08
4052
LM13600

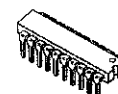

74HC373

Voltage Regulators

The three voltage regulators are polarized and must be mounted so that their tabs correspond to the tab markings on the circuit board graphics. Solder all three leads and clip any excess off flush with the solder joint.

() IC19	7805	+5V Voltage Regulator
() IC14	7912	-12V " "
() IC20	7808	+8V " "

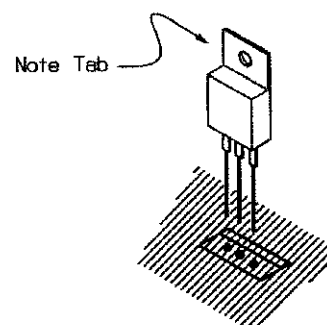

LEDs

-- See Errata on inside back cover.

Note that the LEDs are polarized by the flat in the collar at the base of part. When properly installed, this flat will align with the corresponding flat in the LED symbol printed on the circuit board.

If you are assembling the board for Desk Case enclosure mounting follow the special instructions for mounting in the 9308C Supplement.

When the FatMan is installed behind a rack panel, the three LEDs will be supported by their leads and engage the holes in the front panel. Push the two leads through the holes provided in the circuit board and space the LED above the board by about 1/2". Solder both leads and check the spacing from the board to the LED before trimming the leads off flush with the solder joint.

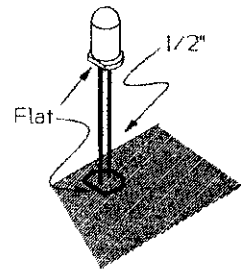

DESIGNATION TYPE

- () D2 Red LED
- () D12 Red LED
- () D13 Red LED

"Flying" Wires

(i.e. those which go from circuit board to panel mounted parts.)

In the following steps, wires will be soldered to the FatMan board which in later steps will be connected to the front panel controls and switches. At each step, cut a piece of wire to the specified length and strip 1/4" of insulation from each end. Twist the exposed wire strands together and "tin" them by melting a small amount of solder into the strands. This will make soldering easier when the wires are installed and prevents fraying of the wire strands when they are pushed through the holes. Solder each connection as it is made and clip any excess wire from the solder side of the board.

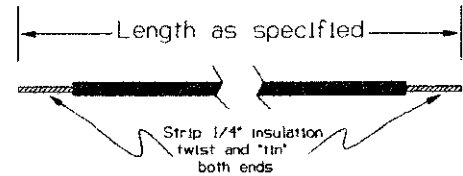

Wire lengths for the Desk Top enclosure are detailed in the 9308C Supplement.

For mounting behind a rack panel use the lengths below.

PC POINT	WIRE LENGTH	PC POINT	WIRE LENGTH
() "A"	9-1/2"	() "T"	9"
() "B"	10-1/2"	() "U"	13-1/2"
() "C"	9-1/2"	() "V"	13"
() "D"	7-1/2"	() "W"	10-1/2"
() "E"	10-1/4"	() "X"	9-3/4"
() "F"	6"	() "Y"	13-1/4"
() "G"	9-3/4"	() "Z"	9-1/4"
() "H"	7-1/4"	() "AA"	11-1/2"
() "I"	14-1/2"	() "AB"	14"
() "J"	12-1/4"	() "AC"	15"
() "K"	13-1/2"	() "AD"	15-1/2"
() "L"	12-3/4"	() "AF"	2-1/2"
() "M"	6"	() "AG"	8-1/2"
() "N"	12-3/4"	() "AH"	8-1/2"
() "O"	7-1/4"	() "AI"	8-1/4"
() "P"	5-1/2"	() "AJ"	5-1/4"
() "R"	5-1/2"	() "AK"	12"
() "S"	4"	() "DG"	18"

Notice that circuit board point "AE" does not yet have a wire connected to it.

Before putting the circuit board aside while you mount parts on the front panel, kick back and admire your work to this point. Be critical - are the solder joints nice and shiny? Are there any blobs of solder on the board that could use cleaning up? (see SOLDERING on page 2) Are the polarized components oriented properly?

Front Panel Controls

When installing in a Desk Top enclosure reference the figures in the 9308C Supplement.

Now we will put the circuit board aside temporarily and mount the controls, switches and jack. If you have the optional panel or case available from PAiA, you will be installing these parts at the locations shown in fig 2. Note that this figure shows the panel from the rear.

() Using the flat washers and nuts supplied, mount the eighteen potentiometers in the locations shown in fig 2. Note that five different values are used so be careful that the correct value is placed in the correct location. Orient the pots so the solder lugs are as shown in fig 3 (NOT fig 2) and fully tighten the nuts to secure them. A hint: marking the part number (e.g. R104) on the back of the pots with an indelible pen will make later wiring easier and less prone to error.

() Using the nuts and washers supplied, mount the three miniature toggle switches in the locations shown in fig 2. While the circuitry only requires SPST switches (with two solder lugs) the parts supplied will most likely be SPDT types (with three lugs) and only two of the lugs will be used. Orient the switches as shown in fig 3 and fully tighten the nut to secure it. The switches are symmetrical so whichever lug is at the top is lug #1

() Using the nut and washer supplied with it, mount the 1/4" Open Circuit Phone jack as shown in fig 2 and orient as shown in fig 3 before fully tightening the nut to secure it.

Now we'll do some preliminary wiring on the front panel parts as shown in fig 3. At each step prepare a wire of the length specified by stripping 1/4" of insulation from the end and twisting and tinning the exposed strands.

Individual solder lugs are identified by part number and lug number. For example, R113-3 means the lug labeled "3" of the Potentiometer R113 as shown in the illustration.

This convention will be followed in these steps: Do not solder a connection to a lug until told to do so with an instruction such as (s2), which means that at that point there will be two wires on the lug in question. If there are not the number of wires specified at the lug when you get ready to solder, recheck to see what has gone wrong. Connections which should not be soldered yet will be marked (ns) for NO SOLDER. On these unsoldered connections simply push the end of the wire through the lug and crimp it back to mechanically secure it.

Bend or remove this tab so that the pot will seat flush against the front panel.

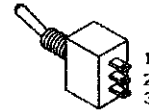
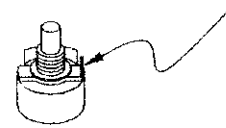

SPDT switches may be supplied even though only SPST are required.

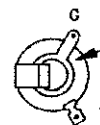
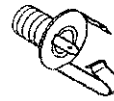

The ground ("G") lug attaches to the threaded bushing.



In some cases connections are made between adjacent lugs of a potentiometer using scrap leads salvaged from circuit board component installation. These connections have the length specified as "Clipping". Sequence is by columns.

Proper wire lengths for Desk Top enclosure are given in the 9308C supplement.

FROM	TO	LENGTH	FROM	TO	LENGTH
() R113-1 (ns)	J6-G (s1)	2"	() R114-2 (s1)	R114-3 (ns)	Clipping
() R113-2 (s1)	J6-H (s1)	3-1/4"	() R96-1 (s1)	R92-1 (ns)	3-1/2"
() R113-1 (s2)	R104-1 (ns)	2-1/2"	() R96-2 (s1)	R96-3 (ns)	Clipping
() R104-1 (s2)	R102-1 (ns)	2-1/4"	() R90-3 (s1)	R74-3 (ns)	4-1/2"
() R102-1 (s2)	R71-1 (ns)	4-3/4"	() R92-2 (s1)	R92-3 (ns)	Clipping
() R104-3 (s1)	R69-3 (ns)	7-1/4"	() R92-1 (s2)	R94-1 (ns)	2-1/4"
() R71-1 (ns)	R69-1 (ns)	2-1/4"	() R94-2 (s1)	R94-3 (ns)	Clipping
() R69-1 (s2)	R115-1 (ns)	2-1/4"	() R82-1 (s1)	R84-1 (ns)	2-1/4"
() R115-1 (ns)	S3-1 (s1)	2-3/4"	() R82-2 (s1)	R82-3 (ns)	Clipping
() R71-3 (ns)	R32-3 (ns)	7-1/4"	() R84-2 (s1)	R84-3 (ns)	Clipping
() R32-3 (s2)	R32-2 (s1)	Clipping	() R40-1 (ns)	R40-2 (s1)	Clipping
			() R40-3 (s1)	R34-2 (ns)	4"

Two resistors are mounted directly on the solder lugs of the potentiometers. Install the resistors by pushing their leads through the lugs until the component is about 1/4" from the pot. Bend the leads back and cut off any excess. Crimp the leads to the lug to hold the part in place.

DESIG.	VALUE	COLOR CODE	From	To
() R33	1800 ohms	brown-grey-red	R34-1 (ns)	R34-3 (ns)
	(slip a 1/2" long piece of sleeving over each lead of R73 before installing.)			
() R73	100 ohms	brown-black-brown	R74-1 (s1)	R71-1 (s3)

When assembling in a Desk Top enclosure, wiring between the controls and circuit board will be done before case installation. Skip the following two steps and continue on page 14.

The circuit board may now be mounted to the rear of the front panel as shown in fig 2. Locate the two "L" brackets that will be used in this operation and notice that each bracket has one threaded hole and one unthreaded hole.

() Attach the "L" brackets to the circuit board using machine screws through the unthreaded hole secured by nuts. Use a 4-40 X 1/4" screw to secure the left bracket. On the right bracket use a longer 4-40 X 1/2" machine screw and #4 flat washer to also attach the cable clamp to the bottom of the board. Some adjustment of bracket and cable clamp position will be necessary in the following steps, so do not fully tighten this hardware yet.

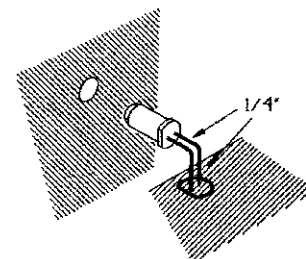

() Attach the circuit board to the front panel by passing two 4-40 X 1/4" screws through the panel into the threaded holes in the brackets. Bend the LEDs so they are parallel to the board and can engage the holes provided for them in the front panel. Fully tighten the screws that pass through the panel into the "L" brackets.

Wiring of the FatMan continues by connecting the wires previously soldered to the circuit board to the pots and jacks as detailed in figs 4a&b. Notice that previous wiring has been eliminated from these drawings to give a better view of the present operations.

These connections shown in fig 4a.

The connections below are shown in fig 4b.

FROM POINT TO

() "A" R34-3 (s2)
 () "B" R34-2 (s2)
 () "C" R34-1 (s2)
 () "D" R40-1 (s2)
 () "F" R56-1 (s1)
 () "G" R56-2 (s1)
 () "H" R56-3 (s1)
 () "N" R90-2 (s1)
 () "O" R82-3 (s2)
 () "P" R84-3 (s2)
 () "R" R84-1 (s2)
 () "V" R90-1 (s1)
 () "W" R92-3 (s2)
 () "X" R94-3 (s2)
 () "Y" R96-3 (s2)
 () "Z" R94-1 (s2)
 () "AG" R115-1 (s3)
 () "AH" R32-1 (s1)
 () "DG" S1-2 (s1)

FROM POINT TO

() "E" R69-2 (s1)
 () "I" R114-1 (s1)
 () "J" R114-3 (s2)
 () "K" R74-3 (s2)
 () "L" R74-2 (s1)
 () "M" S3-2 (s1)
 () "S" R115-3 (s1)
 () "T" R115-2 (s1)
 () "U" S1-3 (s1)
 () "AA" R102-3 (s1)
 () "AB" R102-2 (s1)
 () "AC" R104-2 (s1)
 () "AD" R113-3 (s1)
 () "AF" S4-3 (s1)
 () "AI" R71-3 (s2)
 () "AJ" R69-3 (s2)
 () "AK" R71-2 (s1)

Power Transformer

The final connections are made using the wires from the wall-mount power transformer PWR1. If this part has a connector on the end of its cable, remove and discard it as shown.

- () Separate the power cord coming from PWR1 into two wires for a distance of 2" (**5-1/2" when installed in Desk Top enclosure**). Strip 1/4" of insulation from the ends. Twist and tin the exposed wire strands.
- () For rack panel installation pass the power cord through the cable clamp and knot the cord so that the 2" wires extend beyond the clamp.
- () In 9308C installation fit the 1/4" rubber grommet into the hole provided for it as shown in fig 5. Pass the power cord through the grommet and put a knot in the cord 5-1/2" from the tinned ends.
- () Connect and solder one of the wires from the power cord to lug #2 of switch S4. The wires from the PWR1 are interchangeable so either one can be used in this step.
- () Connect and solder the second transformer wire to circuit board point "AE"

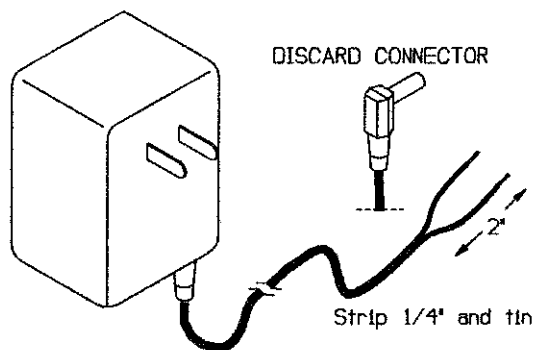

- () Install the knobs. Tighten the set screw slightly and rotate the knob back and forth to see how well it's range of rotation is balanced with the panel graphic. Reorient if not satisfied and fully tighten the set screw when done (not too tight.)

Socket Mounted ICs

When seating the EPROM and uP in their sockets, make sure polarizing marks on the IC and the socket correspond. If the IC pins do not align closely enough to the holes in the socket, reform them. Be very careful that pins go into the socket holes and don't bend underneath the part. IC3, the 2764 EPROM, will be identified by the copyright notice on the part.

DESIGNATION	DESCRIPTION
-------------	-------------

- | | |
|---------|--------------------------------|
| () IC1 | 8031 MicroController |
| () IC3 | 2764 EPROM (w/FATMOP firmware) |

- () Attach the aluminum radiator fin to the tab of IC19 Using a 4-40 X 1/4" Machine Screw and #4 nut as shown in the illustration.

-- See Errata on inside back cover.

THIS COMPLETES THE ELECTRONIC ASSEMBLY OF THE FatMan.

Before plugging the unit in and testing it, take a break then come back and check your work completely.

TESTING AND TUNING

After rechecking your work, it's time for the all important smoke test. If anything unfortunate is going to happen, this is the most likely time.

Plug the wall-mount transformer into a 120-VAC outlet and toggle the FatMan power switch to "ON." The LED to the left of the switch should light and if it doesn't, you should immediately unplug the unit from the wall and find out why. The problem could be nothing more than a dead wall outlet or bad wiring of the Power switch S4. Check the orientation of all Integrated Circuits and polarity of Capacitors (particularly C26, C27 and C30-C33 in the power supply) and diodes (particularly D10 and D11). Solder bridges on the circuit board may be the cause or a poor solder connection almost anywhere.

When the POWER LED lights. Let the unit idle for a few minutes while you check for parts that may be getting hot (ICs in particular) or any unusual smell, smoke, sparks, etc. Some parts WILL get hot during normal operation and these are the 1W resistors that form R117 and the voltage regulators (IC14, IC19 and IC20). Some parts will get warm over a period of 10-15 minutes, particularly the uP and PROM (IC1 and IC3)

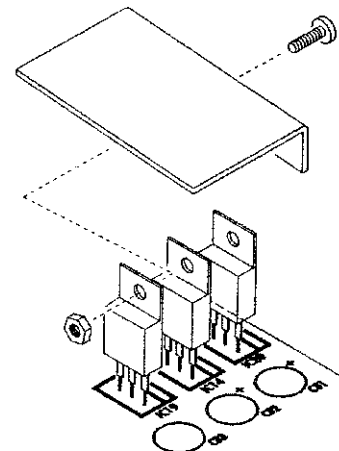

Heat dissipating fin attaches to IC19.

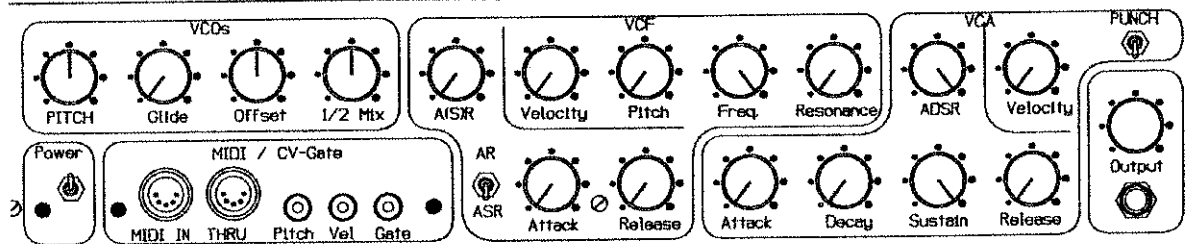

Testing and tuning of the FatMan begins with the controls set as shown above

If nothing seems out of place after a few minutes, hook up a keyboard or other MIDI source to MIDI IN jack and "send in a note" (press a key, for example). The LED to the left of the MIDI IN jack should blink briefly (but brightly) in response to each Note On and Note Off message and light nearly continuously while wheels are being moved or for aftertouch messages. This test is NOT sensitive to failures in other parts of the circuitry (the processor, for instance) and does not require that the transmitting channel of the keyboard and receiving channel of the FatMan agree. If you don't get an indication of data flow, first check to make sure that MIDI is being sent, either with a MIDI Sniffer or by simply monitoring the voltage on pin 5 of the MIDI connectors (the voltage should fall briefly with each message). If MIDI is in fact coming in, check the components associated with this circuitry for proper installation, polarity and so on. In particular check IC6 and IC7 and the polarity of diode D1 and LED D2. Check for the presence of Vcc (+5V.) on pin 14 of IC7 and pin 8 of IC6.

The rest of the tests are sensitive to MIDI Channel Number so at this point set sections 1-4 of the DIP switch so they correspond to the transmitting channel of the keyboard. Most instruments default to sending on Channel 1, which on the FatMan means turning S2 sections 1-4 "ON" (closed). If you need to change to another channel for any reason see the chart on the facing page. Remember that many MIDI keyboards use Running Status and turn notes off with a zero Velocity message. The fatman knows this too, but as with any MIDI receiving device, it has to see the first Note On Status message to know that that's the name of the game. If for any reason it misses that first message (because it was set to a different channel or was turned off so it has "forgotten" the running status) then it will not recognize notes. Turning the keyboard off and back on will re-initialize it so that the first note has the Note On Status word. Sending some event that changes running status (such as a program change) will also work and is usually much quicker.

Press a key on the keyboard and observe that the LED to the right of the GATE output lights while the key is down and extinguishes when the key is released. If this doesn't happen and you are sure of channel correspondence, be suspicious of the uP and digital circuitry (IC1, IC2, IC3 and IC7 in particular). Check soldering quality and that all the wire jumpers are in place and aligned with their graphic. Check for pins rolled under at the sockets for the uP and PROM.

With the previous tests completed, it's time to start listening to the FatMan output. At this time check to see that the adjusting disks of all circuit board mounted trimmer resistors are set to mid-scale (the center of their range of rotation.) Connect an audio cable from the front panel Output Jack to the input of an amp or sound system. The output level of the fatman is a fairly hot "+4dB" that typically can be several volts peak-to-peak. Start with the Output level control turned down low. Set the other panel controls as shown in the illustration above.

Press a key, advance the output level control and you should hear a fairly bright and complex tone. If you don't hear anything, check the obvious first, make sure the amp is on, make sure its speakers are hooked up. Check to see that the MIDI activity and GATE LEDs still respond to the keyboard. Re-check all of your work in the analog portion of the circuitry, which is shown in Schematic 5 b.

If, after taking a break and checking your work further, you still don't see the problem, you will have to do some signal tracing to narrow down what part(s) aren't working. Don't Panic. An oscilloscope is great for this if you have one and know how to use it, but if you don't, the "Signal Tracing the FatMan" information beginning on page 21 shows how to use Walkman headphones as a simple signal tracer.

Once you're hearing a tone from the output, pan the VCO 1/2 Mix control back and forth and observe that at each end of the rotation you hear the sound of a single oscillator. If you don't hear a tone at the extreme Counter ClockWise end (CCW), you should examine the components associated with VCO #1 as detailed in "Signal Tracing the Fatman" on page 21. If there's not output at the ClockWise (CW) end, VCO #2 is having problems and its parts should be examined.

When you've verified that both VCOs are oscillating, it's time to Tune Up. The procedure that we'll use can be done by ear, since it only involves making adjustments to produce tones an octave apart (hardly the kind of thing that requires perfect pitch). If you're more comfortable making technically correct adjustments, substitute a measurement with a frequency counter or use Lissajous techniques to precisely set the octaves. Fatman's lowest C is the one at about 65 Hz. It's highest C is the approximately 1040 Hz one. These are not the precise concert

frequencies for these pitches, but if you tune to these more rational numbers, the VCO Pitch control can easily transpose everything to their exact values.

FatMan responds to a 4 octave range of notes from MIDI note number 36 (24h) to note number 84 (54h). Notes outside that range are ignored. We will name the included notes as C0-C4 to correspond to the convention used by most 4 and 5 octave keyboards. On most 5 octave keyboards the upper 12 semi-tones (C#4 - C5) will not be recognized by the FatMan. If you are using a 3 octave controller, you must check to make sure that its lowest key corresponds to MIDI note number 36.

It's useful to have an understanding of what's happening during tuning so we recommend that you skip to the Design Analysis DAC TUNING section on page 22 before performing the step-by-step tuning procedure that follows.

Here's the procedure step-by-step:

- 1) Rotate the front panel VCO 1/2 Mix control fully ClockWise (CW) so that only VCO#2 can be heard when a note is played.
- 2) Play the lowest C (C0) on the keyboard and adjust the front panel VCO Pitch control for unison with the corresponding note on a piano or synth or other in-tune instrument. If you are using a synth for your keyboard controller, its output will be fine.
- 3) Play the second C (C1) and adjust the DAC Tune trimmer R13 on the circuit board so that the oscillator is an octave above the previous pitch.

If you experience problems here, look at IC1, IC4 and IC5 on the digital side of things. On the CV side, focus your attention on IC8:A & :B, IC9, IC10:B, IC11:A, IC11:B and IC12:A & :B as well as the passive components (Rs and Cs) associated with them in the schematic fig 5a. If a Volt-Ohm Meter reads a positive voltage between about 0.2V and 6V at the wiper of the VCO Pitch control (lug #2 of R34) and the voltage varies as different notes are played, but the pitch of the VCO doesn't change, look closely at the VCO #2 components associated with IC13, IC16, Q5 and Q6.

- 4) Play C4 on the keyboard (remember this will probably not be the highest C on a 5 octave controller) and adjust the front panel VCO Pitch knob for unison.
- 5) Play the next C down (C3) and adjust the Oct 3 trimmer (R18 on the circuit board) for a pitch an octave below the previous one.
- 6) Play the next C down (C2) and adjust the Oct 2 trimmer (R21) for the next octave down.

- 7) Finish by adjusting the Oct 1 trimmer (R24) while playing C1.

If you run into problems with any of the above steps, check the components associated with range switching (IC9, Q1, Q2 and associated passive components). Pay particular attention to the resistor and trimmer divider string consisting of R17-R26.

At this point, VCO #2 should be in tune and playing notes should produce equally tempered intervals. If the notes within an octave are not the proper pitch, it may be an indication that one or more data lines into the DAC have problems. Examine the area of the circuitry around IC4 and IC5.

- 8) Pan the front panel VCO 1/2 Mix control to its midrange position so that both VCOs are audible.
- 9) Play C4 on the keyboard and adjust the front panel VCO Offset control for unison between the two oscillators.
- 10) Play the lowest C on the keyboard and adjust circuit board mounted #1 zero trimmer R42 for unison.

Repeat steps 9 and 10. When no further adjustment of the zero trimmer is necessary for the oscillators to be in unison in step 10, you're done. But, you may want to stop short of that point because some of the more interesting sonic textures are available only when the oscillators are in locked unison at one end of the keyboard and flanging slightly against one another at the other end. In use, you can control which end of the spectrum flanges and which locks with the VCO Offset control and we'll talk more about this as we check the controls individually.

If you run into problems in these last steps, examine closely the VCO #1 components around IC10, IC15, Q3 and Q4. Particularly the front panel Offset pot R40 and the zero trimmer R42.

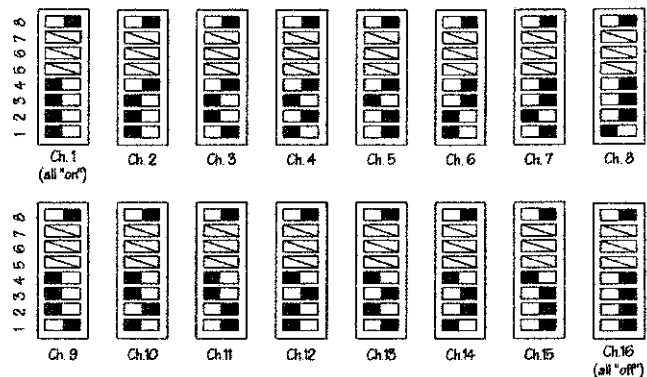

MIDI Channel is selected as shown above

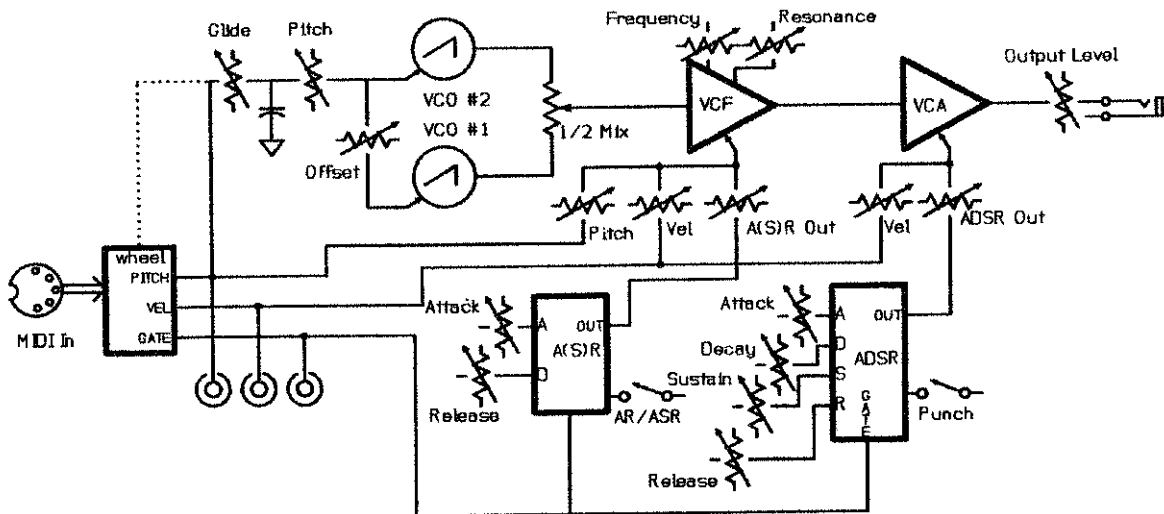

With tuning out of the way, we can start testing controls individually. If you haven't had a lot of experience with analog synthesizers, these procedures will also begin to familiarize you with how the elements effect the character of the sound.

A block diagram showing the FatMan "patch" configuration is shown above. This diagram is by necessity somewhat stylized since some of the connections shown exist only in firmware.

VCO CONTROLS

Together, VCO #1 and VCO #2 provide a harmonically complex, pitched signal source for further processing by the FatMan's VCF and VCA and their associated transient generators.

1/2 Mix: We played with this control earlier, during testing, and verified that it works. It fades back and forth between the two oscillators. In the middle of its rotation the output consists of equal parts of the two VCOs. If the two oscillators are locked in unison, the control will appear to be non-functional since the mix of two identical ramps is the same as either of the ramps. When the VCOs are offset from one another, changing the mix between the higher and lower frequencies of the two give a wide range of control over the harmonic structure being delivered to the filter.

Offset: This control transposes the pitch of VCO #1 over slightly more than a two octave range without significantly effecting VCO #2. At about the center of its range VCO #1 and VCO #2 produce the same pitch. Offsetting one oscillator from another gives gross control of harmonic structure and when the oscillators are close to being in unison (or some interval such as thirds or fifths), but slightly different, additional harmonic complexity is produced because of flanging.

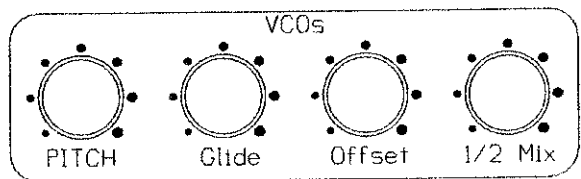

Flanging is the familiar "inside out jet engine" effect that arises when two harmonically correlated signals are slowly changing their phase relationship to one another. Changing is the operative word. When the oscillators lock together the effect disappears.

Pitch: This control transposes both oscillators at the same time either for getting in tune with another instrument or the agile of hand may use it for pitch bend.

Glide: This control sets the rate at which one pitch changes to another as different notes are played. At the CCW end of its rotation the change happens instantly. CW rotation produces a progressively slower glissando from one note to another up to a couple of seconds at the extreme end. When you've played with this control enough to verify its function, leave it set fully CCW.

If you've gotten this far and the glide doesn't act as described above the failure mode has to be that it's not gliss'ing at all, and that almost has to be a problem with C12 or the Glide pot (R32).

VCF CONTROLS

The Voltage Controlled Filter is a low-pass with resonance type. A plot of filter output response to frequency is shown in the illustration on the facing page. The VCF is used to attenuate or accentuate harmonics or ranges of harmonics present in the output of the VCOs, roughly the function of the resonators in natural instruments. Under control of it's AR (Attack / Release) transient generator and the MIDI Velocity data, the filter is responsible for a lot of the timbral dynamics as notes are played.

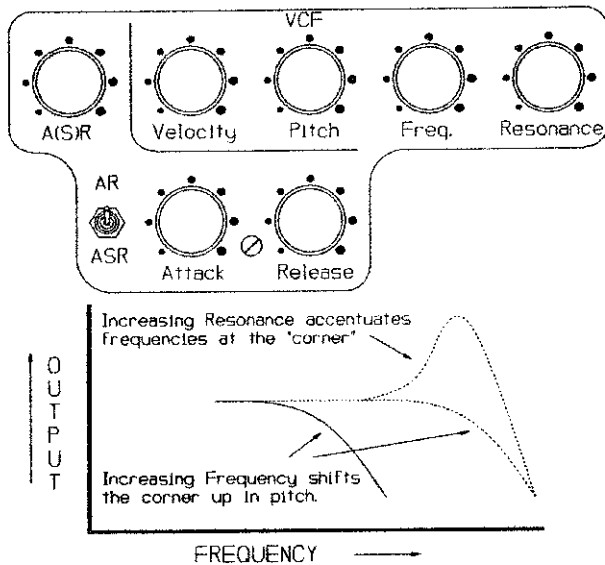

Frequency: The frequency control sets the "corner" frequency of the filter. That is, the frequency above which harmonics are attenuated. This is also the frequency most effected by the Resonance control. While holding down a mid-range note rotate the Frequency control CCW and observe that the tone that you hear gets less bright as the control is rotated.

Resonance: This control sets the "Q" of the filter. That is, the extent to which frequencies close to the corner frequency are accentuated and how much the filter "rings" in response to high frequency transients. While still holding down a mid range note advance this control in a CW direction and observe that the sound gets brighter. Leave the Frequency and Resonance controls set to mid-range.

If the controls do not respond as described, check filter components as detailed in the VCF section of "Signal Tracing the FatMan" on page 21.

A(S)R: This control sets how much the corner frequency of the filter is modulated by the transient generated by the AR in response to notes being played. Assuming that the AR Attack and Release controls are still set to min, advancing this control CW should have roughly the same effect as adjusting the Frequency control (we'll see the big difference in the next step). Leave this control set to about mid-range.

Attack: This control sets how quickly the AR output rises in response to a key being played. As you advance this knob CW while playing notes you should hear that the filter's corner frequency is moving up-scale. At the extreme CW end of its rotation (max) the AR should take several seconds to reach its peak value. Leave this control set to mid-range.

AR / ASR Switch: This switch determines whether the output of the AR sustains while a key is held down or immediately transitions to Release when the Attack interval is done. Toggle this switch to the AR position and observe that the corner frequency of the filter now rises upscale and at the peak immediately resets of a lower value. Leave the switch set to AR.

001015

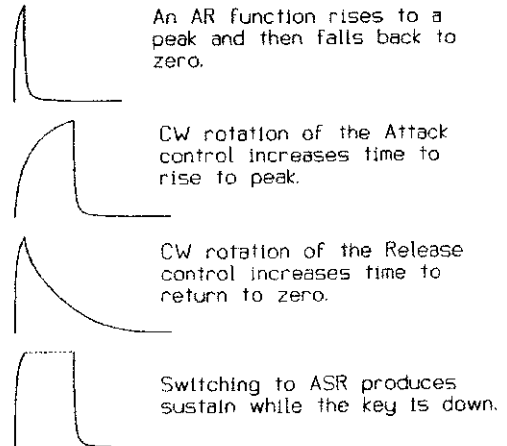

An AR function rises to a peak and then falls back to zero.

CW rotation of the Attack control increases time to rise to peak.

CW rotation of the Release control increases time to return to zero.

Switching to ASR produces sustain while the key is down.

Release: This control sets the rate at which the AR output returns to zero during the Release part of the transient. As you rotate this control toward max (CW) and repeatedly press a key you should observe that the corner frequency takes longer to slide down-scale after reaching the peak. At the max setting of this control the AR output should take several seconds to go from peak output back to zero. Leave the control set at some midrange position.

If there are problems with any of the controls above, focus your attention on IC8, IC12, Q7, D3 and D4 and the passive components in the A(S)R part of the circuitry as shown in the schematic.

Pitch: This control sets the extent to which the corner frequency of the filter is set by the pitch CV that is controlling the VCOs, and consequently how the filter "tracks" the keyboard. Since the Filter in the synthesizer is serving somewhat the same function as resonators in natural instruments, the setting of this control will determine whether the class of instruments being modeled has a fixed resonator (like strings) or a variable resonator (like brass and reeds). At the present setting (min) none of the pitch CV is applied to the filter at all. As the control is advanced, the corner frequency of the filter is effected to a greater extent by the pitch CV. There will be a good bit of interaction between the Frequency and Pitch controls, but in general the filter tracks the keyboard most closely at mid-range settings with undertracking and overtracking happening at the min and max settings of the Pitch control respectively. Leave the control set at some midrange value.

Velocity: This control sets the extent to which the Velocity CV effects the Filter frequency. Assuming that you are using a controller that sends Velocity information, rotating this control toward max (CW) will cause the filter frequency to rise and the output to get brighter as keys are struck more forcefully. Leave the control set to min (CCW).

If the controls don't respond as outlined, check the wiring of the pitch control R71. If there seems to be no Velocity response, check IC8, IC11, IC12, C8 and the panel control R69.

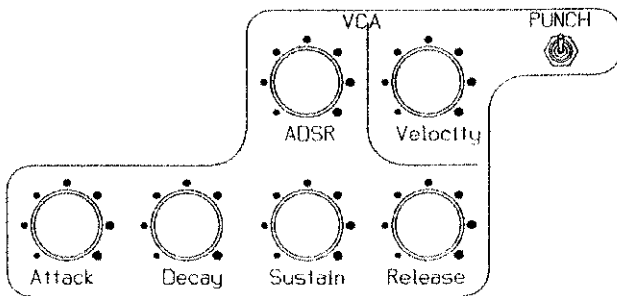

VCA CONTROLS

The VCA and its associated ADSR (Attack / Decay / Sustain / Release) transient generator are responsible for the dynamics of the final sound; that is, how quickly it builds up and dies away and it's sustain characteristics. When verifying the operation of the VCA's ADSR controls, repeatedly press and release keys to observe the effect of the control being discussed. Also, it's best to eliminate any dynamic changes from the filter so that they aren't confused with the actions of the VCA. Set the VCF's A(S)R, Velocity and Pitch controls to min (CCW) and the Freq. and Resonance controls for some pleasing sound.

Attack: This control sets the rate at which the final sound of the output builds up. As you rotate this control toward max (CW) you should hear the sound taking a longer time to swell to its final level. At the max end of its range it should take several seconds for the sound to peak. Leave the control set at some mid-range value.

Sustain: This control sets the steady-state Sustain level reached by the ADSR on completion of the Attack and Decay portions of the response. As you rotate this control back toward min you should hear the output clearly step to a lower level output when the Attack portion of the ADSR transient is done. Leave the control set so that you can clearly hear the difference between the peak reached during Attack and some non-zero Sustain level.

Decay: This control sets the rate at which the ADSR transient falls to the Sustain level when the Attack portion of the output is done. As you rotate this control toward max you should be able to hear that after reaching the Attack peak the output falls more gradually to the Sustain level.

Release: This control sets the rate at which the ADSR level falls to zero when the key is released. Observe that as the control is rotated toward max the time required for the sound to disappear after the key is released gets longer. At the maximum setting it should take several seconds for the tone to completely die away. The exact time will be for any setting of the control will depend on the setting of the Sustain level.

If one or more of the controls do not act as described above, check the ADSR parts as outlined in "Signal Tracing the FatMan" on page 21. If only one control is nonfunctional, concentrate on the parts associated with that control. For example, if the Attack control is behaving strangely focus on Q10, D7, R93 and the panel control R94.

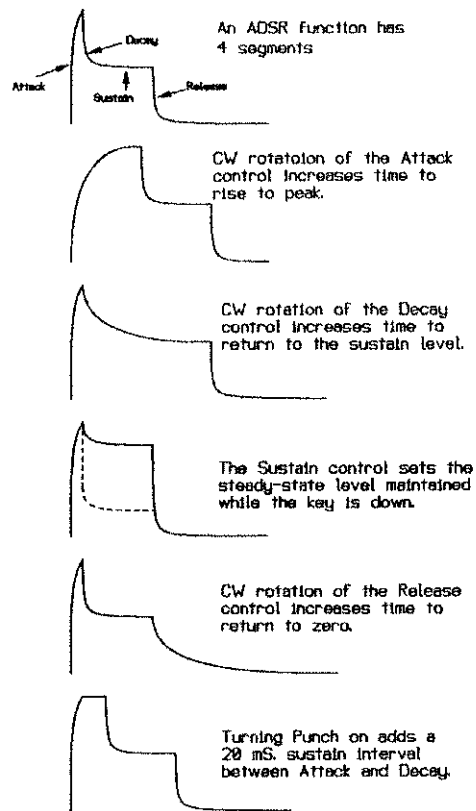

Punch switch: This switch reproduces the tendency of some classic synths to "hang-up" briefly before transitioning from the Attack to the Decay part of the ADSR response. The effect is most noticeable on percussive transients which have short Attack and Decay times and fall to a relatively low (or zero) Sustain level. Set the ADSR with Attack, Decay at min and Sustain at some low level and play notes while toggling between Punch and nonpunch. Observe that with punch off (bat down) this is a fairly "thin" sound without much presence. With Punch on (bat up) the sound produced will be much louder and.. well, "punchier".

Problems? Focus on IC7, IC8, D5, S1 and the passive components R98, R101 and C34.

Velocity: This control sets the amount of effect that the Velocity CV has on the VCA. If you are using a controller that produces Velocity information, rotate the control toward max and note that as the knob is turned CW the output gets louder when notes are struck harder. There will be some interaction with the VCA's ADSR control, as you crank in more Velocity CV you may want to cut back on ADSR CV some.

Problems at this stage almost have to be with the Velocity control R104, since we checked the rest of the Velocity CV circuit while testing the filter.

Signal Tracing the FatMan

A simple audio signal tracer for use with the FatMan consists of a pair of personal stereo headphones plugged into a jack wired so that the two headphone elements are in series and a resistor with a value of about 680 ohms as shown in the illustration to the right.

Connect the lead marked ground to the "G" lug of the front panel output jack J6. Light duty clip leads are ideal for this, but if none are available this connection can be tack-soldered in place. "Probe" a point by touching the tinned end of the wire to the point. At the points outlined you should clearly hear the signal described in the step.

You need NOT have a key pressed for the following tests.

VCO #1

First probe the VCO #1 end of the VCO 1/2 Mix control (lug 1 of R56) to verify that there is an output from this oscillator. If you don't hear a fairly bright tone, check the VCO #1 circuitry which is IC10, IC15, Q3, Q4 and the associated resistors and capacitors as shown in the VCO #1 section of the schematic Fig 5 b.

VCO #2

Probe the output of VCO #2 at lug 3 of R56. If you don't hear a tone here, focus on the components around IC13, IC16, Q5 and Q6. Probe the composite signal of the two oscillators at the wiper of the Mix control (lug #2 R56). Assuming that you heard both oscillators individually, what you are now hearing is the mix of the two.

VCF

Probe the output of the filter (pin 9 of IC17) to see that you are hearing this same tone. If not, check the filter components; IC17, IC13, Q8, Q9 and the associated components as shown in the VCF section of the schematic.

VCA and ADSR

Finally, while holding a note down, probe the VCA output at lug #3 of R113. If the tone's not here, there may be a problem with the VCA itself (IC18, IC13, Q12, D9 and associated parts) or there may be no control voltage output from the ADSR (which is the signal that controls the output level of the VCA). This not an audio signal, so you can't listen to it with the earphones. Instead, use a Volt-Ohm Meter to measure the output voltage of the ADSR (lug #3 of R102). When a note is being played you should see about +7V volts referenced to ground. When the note is released, this voltage should drop to 0V. If you don't get these results, focus your attention on IC7, IC8, IC12, Q10, Q11 diodes D5-D8 and the resistors and capacitor in the ADSR portion of the schematic.

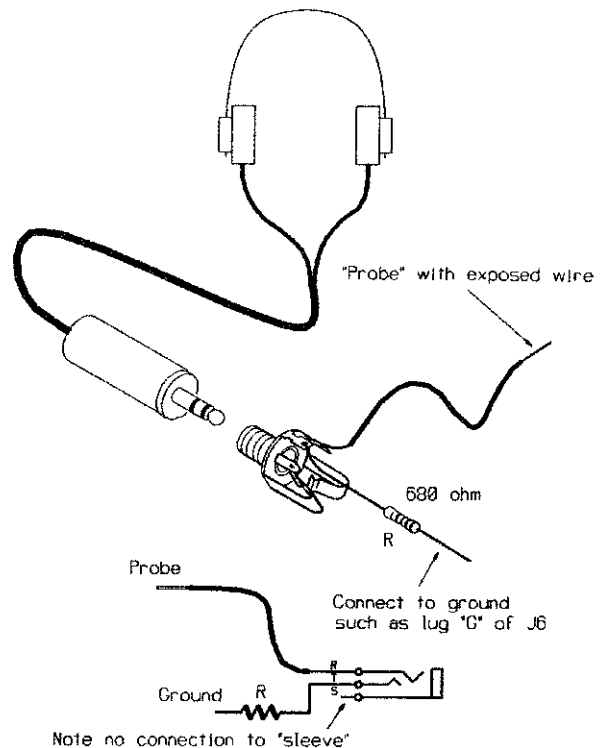

FatMan Design and Tuning Analysis

As shown in fig 5a, the schematic of the digital circuitry, FatMan's brain is an 8031 MicroController (IC1). Firmware for the system is burned into the EPROM (IC3) which is attached to the uP's address and data lines with the Octal Latch IC2. The DIP switch S2 connects to five of the uP's input port lines. Four of the switches in this package are used to select MIDI Channel and the fifth is an unused input to the processor.

The receive (Rx) line of IC1 receives MIDI Data from the mandatory optocoupler IC6 which isolates the ground of the MIDI sending device from FatMan's ground. The output of the optocoupler is also buffered by a pair of Inverter stages (IC7:b & a) which drive the MIDI Thru output J2. A third Inverter stage, IC7:c, drives the LED D2 to give an indication of MIDI activity on the input J1.

DAC TUNING

FatMan's VCOs are linear in the way their frequencies respond to Control Voltage changes. This means that CVs must change exponentially to produce proper pitches. For example, to produce a pitch an octave above the present pitch the CV must double; for an octave lower the voltage must be halved. Linear Digital to Analog Converters are generally no good at generating these kinds of voltage increments because if the DAC is scaled to produce the largest voltage necessary, a couple of octaves lower you're dealing with semi-tone voltage changes that are much smaller than the resolution of the Least Significant Bit.

FatMan gets around this problem by having the DAC (IC5) be responsible for only a single octave's worth of the CV. In tech-talk, the voltages for 12 equally tempered pitches are sparsely mapped along an exponential curve in the 256space of the 8-bit DAC. Octave changes are handled by the ranging network consisting of a 1/4 Multiplexer (IC9) that selects one of four taps on the voltage divider string R17-R26. These component values produce a voltage at each tap that is 1/2 the voltage of the tap above.

On the digital side of things, the DAC is glued to the uP data lines with the octal latch IC4. The ranging MUX is controlled by the processor's T0 and T1 lines. These signals are level shifted to 8V by discrete transistors Q1 and Q2.

In normal operation, the voltage generated by the DAC can be thought of as going from C down to C#, with octave ranging changes happening between C# and the C immediately below it. So that the maximum output range of the DAC can be used (for maximum error of less than one cent), the DAC is ranged to produce a voltage from a nominal 3V for C (FFh into the DAC) down to a nominal .177v for C# (0Eh into the DAC). The 3V offset introduced by the current flow through R12 and R14 causes the voltage from the DAC's output buffer (pin 7 of IC10) to go from a nominal 6V down to a nominal 3.177V.

Huh?

What's this 3.177V business? Well, that is the voltage corresponding to the octave below 6V (which is 3V) plus the voltage required to produce the next semi-tone up. Since in equal temperament each semi-tone has a frequency 1.059 times the preceding semi-tone, and since our Voltage/Frequency response is linear, the next semi-tone above 3V is $3 * 1.059 = 3.177V$ (if you think it's difficult to read, try explaining it some time.)

At the step between C# and the C below it, the DAC buffer output returns to 6V and the octave switching network switches to divide this in half so the CV to the VCOs becomes 3V, which as you now know is the voltage an octave below 6V.

During calibration the output of the DAC as set by R13 is adjusted so that it exactly matches the offset voltage from R12 and R14. When these conditions are met, the output of the buffer will be some voltage X in response to the maximum DAC output (FFh as data) and exactly X/2 when the DAC is contributing no output at all (00h as data). We've stated the "nominal" value of x as 6V, which may seem sort of sloppy (the actual voltage may be as low as 5V.) until you realize that it's the ratio of 2:1 that matters, and not the exact value of the voltages.

The DAC must be tuned over the octave from C0 to C1 because C0 is the only C that causes 00h to be sent to the DAC. In firmware, this lowest C is an exception to the normal ranging that happens between C# and C.

Once the DAC is tuned, the trimmers that set octave intervals (R18, R21 and R24) are adjusted so that the pitch changes by octaves as you go down the keyboard by octaves. These adjustments do not interact between themselves or with the tuning of the DAC, so you usually only have to go through them once for them to be right, and the circuitry is simple and stable so they tend to stay right for a long time.

In the final calibration step, the two VCOs are made identical by adjusting the zero offset of VCO #1 so that it's the same as VCO #2. A subtlety of the tuning process is that it compensates for any zero offset in VCO #2 (which means that exactly zero voltage may not produce exactly zero frequency, trickier than it sounds). So as long as VCO #1 is the same, everything is wonderful.

The single output of the DAC and Octave Range Switcher is split into Pitch and Velocity CVs with the sample and hold circuits built using OpAmps IC12:a&b, CMOS switches IC11:a&b and capacitors C7 and C8. System firmware outputs values to the DAC and Range Switcher corresponding to the Pitch CV then turns on IC11:a to sample the voltage by charging capacitor C7. IC11:a is then turned off to isolate the voltage on C7. The processor then repeats these actions for the Velocity CV, turning on the second CMOS switch (IC11:b) to charge C8. The voltages on the capacitors are read out by their corresponding OpAmp buffers IC12:a & :b. Comparators IC8:a&b provide level translation from 5V to the higher voltage needed for the CMOS switches by tying their open collector outputs to the 8V rail through R29 and R30.

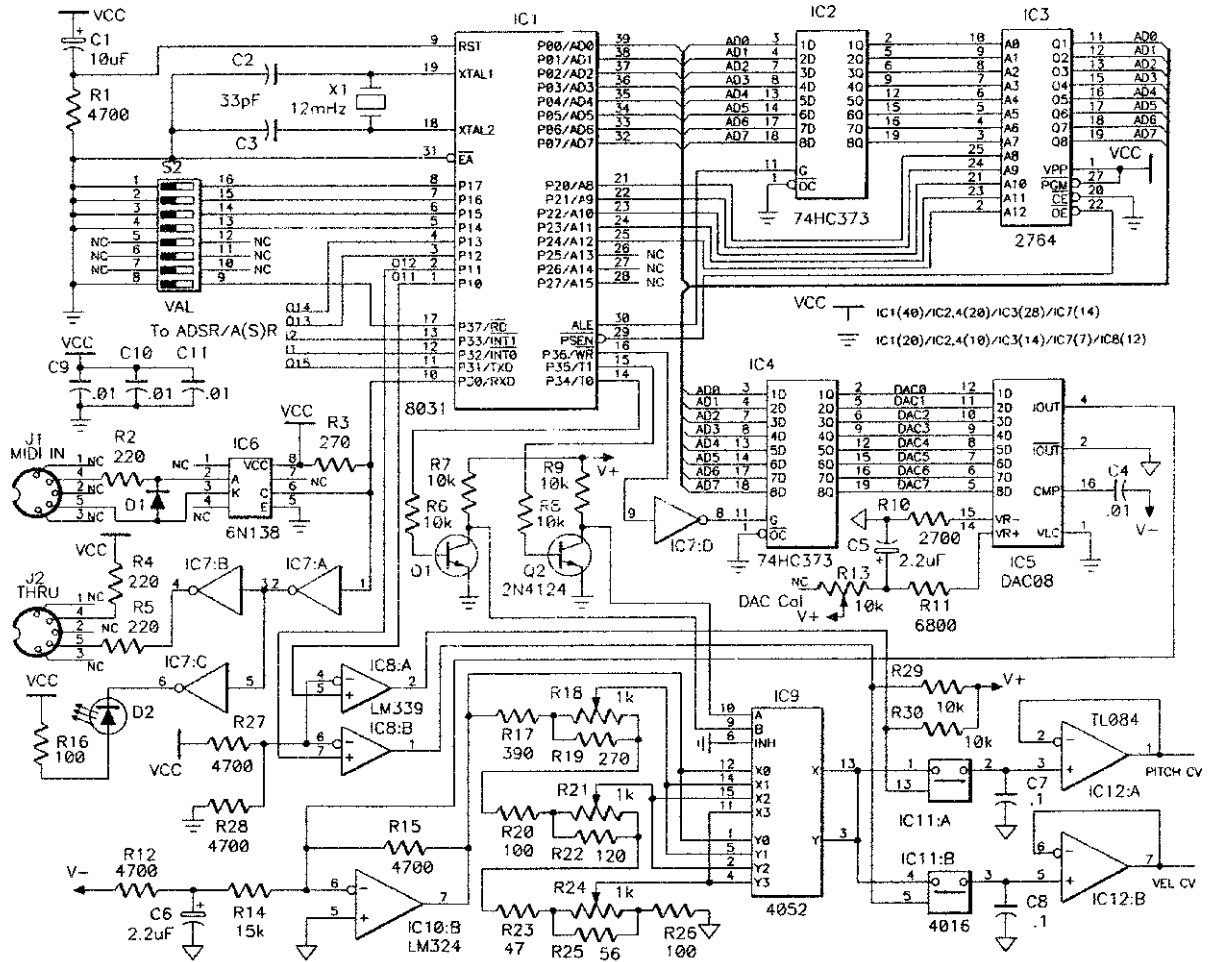

Fig 5a. An 8031 uProcessor provides the computing horsepower needed to decode MIDI and keep Control Voltages straight. Equally tempered Control Voltages are provided by the combination of the DAC and Octave Range switching.

Leaving the bits and bytes behind, we turn our attention to the analog sound generating and processing part of FatMan shown in fig 5b.

What would an analog synth be without a GLIDE control to grab and twist for really expressive portamento? FatMan uses the common approach of charging a capacitor (C12) through a variable resistor (R32). IC10:a buffers the voltage on the capacitor and drives the Master Pitch control R34 which is used to transpose both oscillators over slightly more than an octave range.

The two VCOs are identical except for the Offset control (R40) which allows the pitch of VCO #1 to be raised and lowered an octave relative to VCO #2. VCO #1 also has a trimmer that allows its zero intercept to be adjusted to match that of VCO #2.

Taking VCO #1 as being otherwise typical, the Pitch CV drives a voltage to current converter (V/I) consisting of IC10:c, transistors Q3 and Q4 and the associated resistors. The current output of this circuit, from the collectors of the transistors, charges capacitor C14 and produces a linear voltage ramp which is read out by the buffer amp IC10:d. IC16 is a 555 type timer that senses when the voltage ramp at the output of the buffer exceeds a threshold at which point an internal transistor is turned on to short out the capacitor and quickly discharge it. When the capacitor discharges to a lower threshold the transistor is turned off and the capacitor can once again charge and repeat the cycle.

The result of this relatively slow charging and quick discharging is a ramp (sawtooth) waveform and in the interest of simplicity this is the only oscillator waveform available. A ramp is the most harmonically rich of the common waveforms, having both the even harmonics of a triangle and the odd harmonics of a pulse. The filter can be used to track the pitch of the oscillators and reject all harmonics in the ramp leaving only the fundamental sine wave.

Potentiometer R56, the Osc1/Osc2 Mix control, allows the VCF to be driven by either VCO1 or VCO2 or a mix of the two. The VCF design is a State Variable Filter which has been configured to give a low-pass response with resonance, adjustable with R114, at the corner frequency. The filter is built around IC17, an LM13600 type Dual Operational Transconductance Amplifiers (OTA) with C20 and C21 as the tuning capacitors. Two control currents for setting the gain of the two OTAs in IC17 are produced by the V/I consisting of IC13:d, Q8, Q9 and associated resistors. Four separate voltages are summed to set the corner frequency of the filter; a static voltage that sets the initial frequency is adjustable with R74, Velocity CV adjustable by R69, Pitch CV adjustable by R71, and finally the output of the filter's dedicated transient generator adjustable with R115.

The filter's AR transient generator works by charging C22 through R83 and R84 for the Attack portion of the cycle and discharging it through R81 and R82 for the Release section. Charging and discharging currents are steered by D3 and D4 as Q7 is switched on and off by the TxD line of the uP. Voltage on the capacitor is buffered by IC12:c and the comparator IC8:c monitors the buffer's voltage and switches the processor's INT1 input when the peak voltage is reached. The firmware's response to this is to

switch from Attack to Release. Closing the Sustain switch S3 prevents this "peak reached" signal from getting back to the uP so that the Release portion of the cycle won't happen until the key that initiated the response is released. The result is to switch the transient from a non-sustaining AR to an Attack / Sustain / Release (ASR) response.

FatMan's Voltage Controlled Amplifier uses one OTA from IC18. The main components of the V/I that control this element are IC13:c and Q12. This voltage to current converter is unlike the others in that it must be stable for zero control voltage (so the VCA can turn off completely). Adding D9 to the circuit clamps the output of IC13:c and keeps it from going negative and C24 provides frequency compensation for the high loop-gain state that exists at near-zero control voltages

The Attack/Decay/Sustain/Release (ADSR) transient generator dedicated to the VCA is similar to the filter's A(S)R. Under control of a pair of the uP's output lines (P12 & P13), capacitor C19 charges and discharges through steering diodes D6-D8 at rates set by R92, R94 and R96. The Sustain control R90 sets the voltage level to which the Decay portion of the cycle falls. IC12:d buffers the voltage on the capacitor and comparator IC8:d signals the processor when the peak of the Attack is reached.

When the Punch switch S1 is closed the combination of C34 and R98 add a slight delay (about 20 ms.) between the time that the ADSR reaches its Attack peak and the time that this information reaches the uP. The result is a short Sustain interval that adds punch to sounds with fast Attack and Decay dynamics. When S1 is open, the ADSR behaves in the normal, technically correct way.

FIRMWARE

The FatMan firmware is responsible for recognizing MIDI Note On and Off messages and breaking them down into Note number and Velocity values. Note number is checked for being in the range of 36-84 and then converted into octave ranges by division and the data required to drive the DAC by look-up table.

The Velocity data from Note On and Off messages are handled in much the same way, except that the 0 to 127 step range of this data is first scaled to range from 36-84.

Pitch Wheel messages are also supported. In the FatMan, Wheel data modulates the Pitch data before it gets to the DAC. This is possible because only 12 of the 256 possible values of the DAC are used for pitch and the space between these values is available for modulation. Musical range of FatMan's Pitch Wheel is +/- a semi-tone. Since there are no pitches available above the highest C or below the lowest, wheel data is ignored on these bends.

The firmware is also responsible for turning on and off the proper sample and hold at the proper time to produce Pitch and Velocity CVs. It manages the A(S)R and ADSR transient generators, turning on their Attack cycle when a note is played and managing Decay, Sustain and Release as appropriate for the status of the transient and any Note Off messages which may be received.

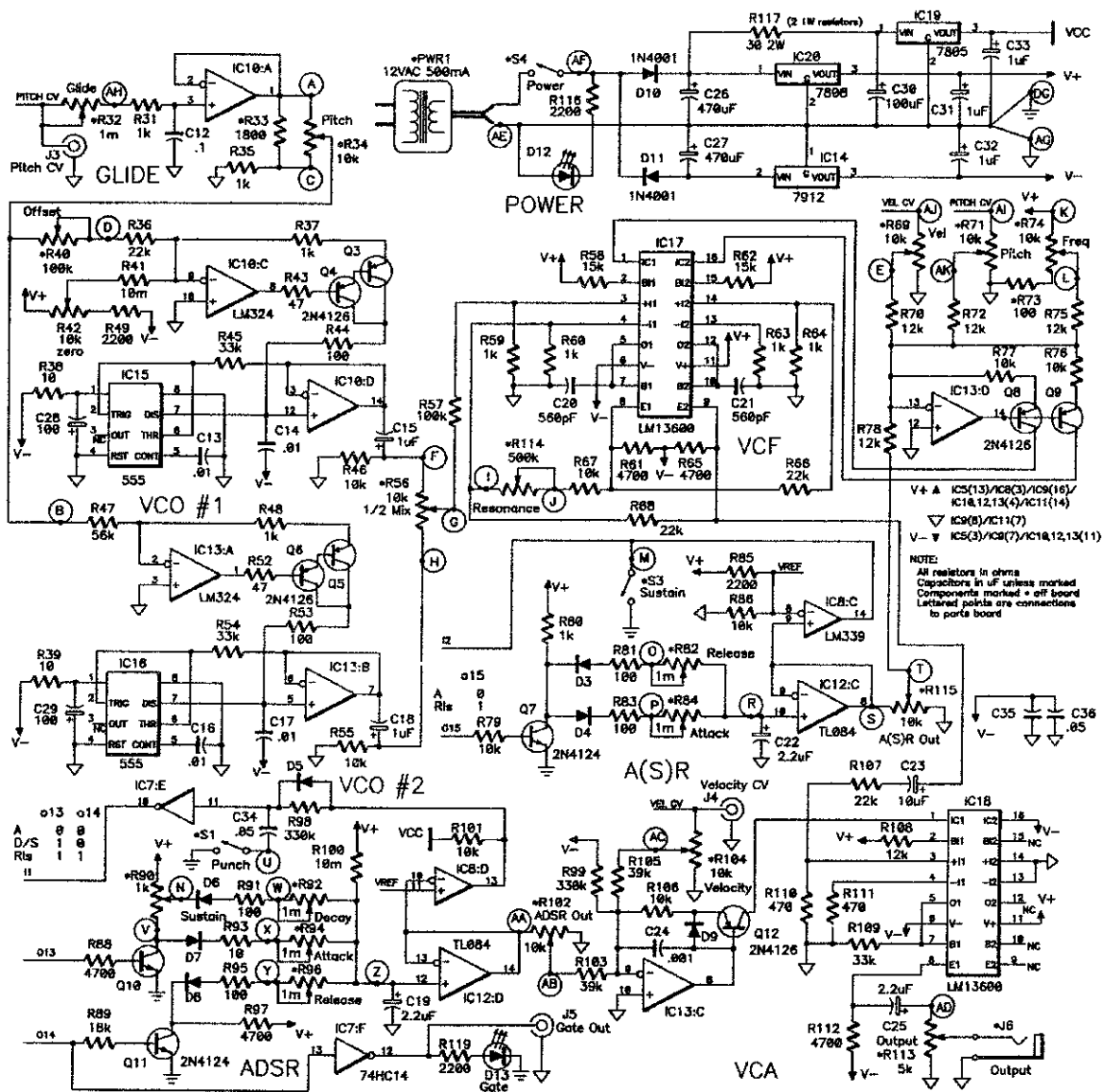

Fig 5b. The FatMan analog circuitry comprises two VCOs, low-pass VCF with AR Transient Generator, and VCA with ADSR Transient Generator

Errata for Fatman Manual

Page 2 First paragraph, last sentence should read “Check the parts supplied against the packing list on page 3 of this manual”.

Page 3 Packing List

- 1 Voltage Regulator Cooling Fin
is now
- 1 Heatsink, TO220 – clip-on style

Page 10 Voltage Regulators

Install clip-on style heatsink on IC19 (7805) before installing on printed circuit board.

Page 15 Socket Mounted ICs

Disregard the statement to “attach the aluminum radiator fin ... in the illustration” and the illustration to the right. The heatsink for this part is now a clip-on style and was installed on the regulator back on page 10 when you were installing all the regulators.

PAIA Electronics, Inc

phn (405) 340-6300

9308K FatMan MIDI Analog Synth Illustration Supplement

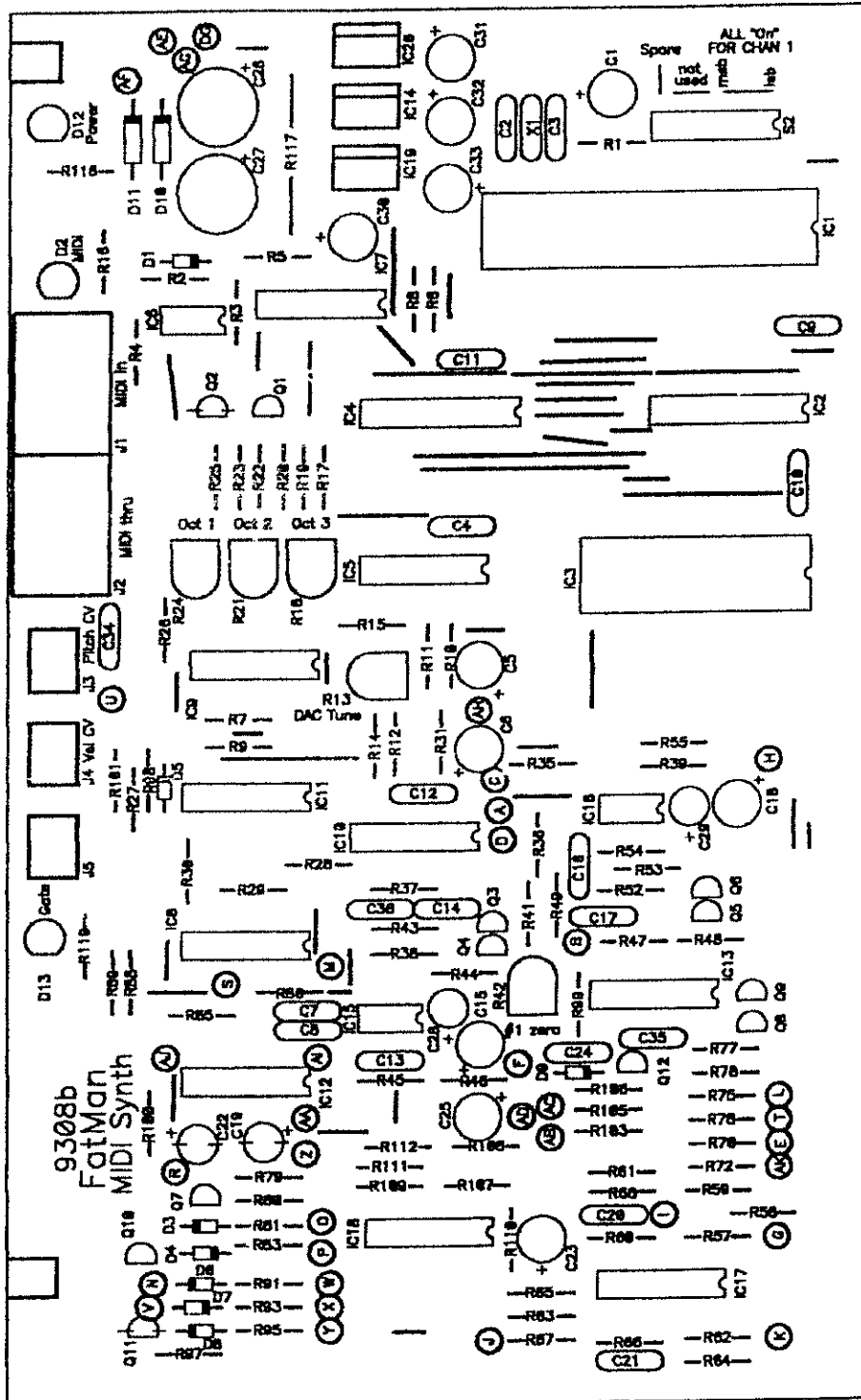

Fig 1a. Components are placed on the FatMan circuit board as shown in this parts placement drawing

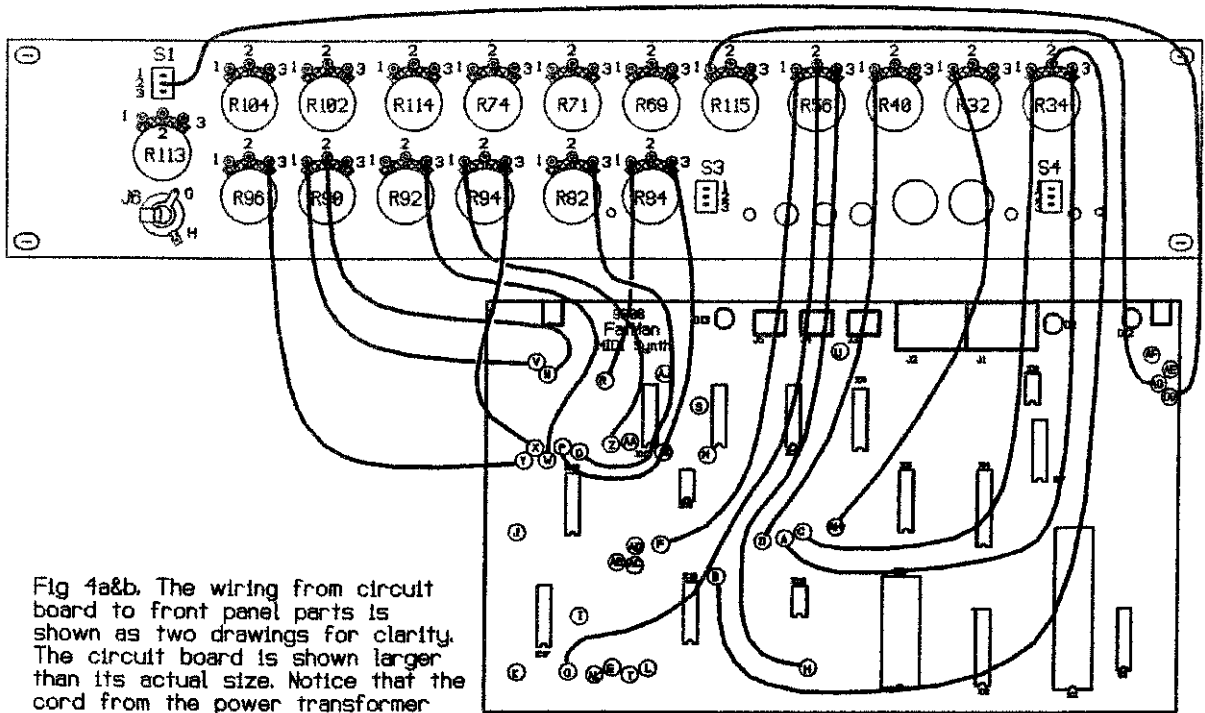

Fig 4a&b. The wiring from circuit board to front panel parts is shown as two drawings for clarity. The circuit board is shown larger than its actual size. Notice that the cord from the power transformer passes through the nylon cable clamp and is knotted for strain relief.

