



duoVerb
Pilot's Handbook

An in-depth exploration of the revolutionary technologies and tonal pleasures of the Duoverb.

Electroponic Limited Edition. Also available at www.line6.com. Revision A.

The serial number can be found on the back panel of your Duoverb. It's the number that begins with "21". Please note it here for future reference:

SERIAL NO: _____

WARNING: To reduce the risk of fire or electric shock, do not expose this appliance to rain or moisture.

CAUTION: To reduce the risk of fire or electric shock, do not remove screws. No user-serviceable parts inside. Refer servicing to qualified service personnel.

CAUTION: This equipment has been tested and found to comply with the limits for a Class B digital device pursuant to Part 15 of FCC Rules. Operation is subject to the following two conditions: (1) This device may not cause harmful interference, and (2) this device must accept any interference received, including interference that may cause undesired operation.



The lightning symbol within a triangle means "electrical caution!" It indicates the presence of information about operating voltage and potential risks of electrical shock.



The exclamation point within a triangle means "caution!" Please read the information next to all caution signs.

YOU SHOULD READ THESE IMPORTANT SAFETY INSTRUCTIONS KEEP THESE INSTRUCTIONS IN A SAFE PLACE

Before using your Duoverb, carefully read the applicable items of these operating instructions and safety suggestions:

1. Obey all warnings on the Duoverb and in this Pilot's Handbook.
2. Do not place near heat sources, such as radiators, heat registers, or appliances which produce heat.
3. Guard against objects or liquids entering the enclosure.
4. Connect only to AC power outlets rated 100-120V or 230V 47-63Hz (depending on the voltage range of the unit; refer to the back panel). Current ratings should be 4A for the 120V range and 2 A for the 230V range.
5. Do not step on power cords. Do not place items on top of power cords so that they are pinched or leaned on. Pay particular attention to the cord at the plug end and the point where it connects to the amp.
6. Unplug your Duoverb when not in use for extended periods of time.
7. Do not perform service operations beyond those described in the Duoverb Pilot's Handbook. In the following circumstances, repairs should be performed only by qualified service personnel:
 - liquid is spilled into the unit
 - an object falls into the unit
 - the unit does not operate normally or changes in performance in a significant way
 - the unit is dropped or the enclosure is damaged
8. Prolonged listening at high volume levels may cause irreparable hearing loss and/or damage. Always be sure to practice "safe listening."



Please Note:

Line 6, Duoverb, Vetta, POD and Flextone are trademarks of Line 6, Inc. All other product names, trademarks, and artists' names are the property of their respective owners, which are in no way associated or affiliated with Line 6. Product names, images, and artists' names are used solely to identify the products whose tones and sounds were studied during Line 6's sound model development for this product. The use of these products, trademarks, images, and artists' names does not imply any cooperation or endorsement.

Welcome to Duoverb	1•1
---------------------------------	-----

Working It

Quick Start Guide	2•1
Front Panel Features	2•2
Amp 1 & 2 Foot Switch.....	2•4
Manual Mode: What You See Is What You Get.....	2•5
Using The Channel Memories.....	2•5
Rear Panel Features.....	2•6
Using Your Direct XLR Outputs.....	2•8
Connecting External Speakers.....	2•9
Hooking up your Combo in stereo to a single Duoverb 2x12.....	2•9
Hooking up your HD in stereo to a closed back 2x12.....	2•9
Hooking up your HD in mono to a single Duoverb 4x12.....	2•10
Hooking up your HD in stereo to a single Duoverb 4x12.....	2•10
Hooking up your HD in side by side stereo with two 4x12s.....	2•11
Hooking up your HD in stacked stereo with two 4x12s.....	2•11
Hooking up your HD in side by side stereo with two 2x12s.....	2•12
Hooking up your HD in stacked stereo with two 4x12s.....	2•12

The Amps

General Notes About the Models.....	3•1
What's In There.....	3•2

Using Your Feet

FBV Class Foot Controllers.....	4•1
Connecting an FBV.....	4•1
So What Do All These Buttons and Pedals Do?.....	4•2
Saving and Naming with an FBV.....	4•4

Appendices

MIDI Capabilities.....	5•1
MIDI Program Change Values.....	5•1
MIDI Continuous Control Messaging.....	5•2, 5•3
Customer Service.....	5•4

WELCOME TO DUOVERB

Register

Thanks for buying a Duoverb! Please send in that included registration card or click on over to www.line6.com to get registered. We'll wait right here...

Connect at www.line6.com

Join the thriving community at www.line6.com. The discussion boards are humming with Line 6ers sharing insights to get the most from their gear and the great adventure of making music. Learn what's new from the artists that rely on Line 6, be the first to hear about new products, and tap into Customer Support.

Line 6 and Duoverb

You probably know Line 6 as a technological innovator in the guitar world—first to put digital software modeling technology to work in guitar combo amps, pioneering direct recording technology in POD and other products, and capturing the soul of classic pedals in modern stomp boxes. We make gear that's packed with features and hi-tech breakthroughs, and bring new value and capabilities to guitarists.

With Duoverb, we've taken the benefits of all that innovation and focused it down to the bare essentials in what we like to think of as the ideal fusion of technology and tradition: 60 years of amp greatness waiting for you in one box.

Avoiding elaborate features and complication, Duoverb's got the look and feel of classic tube amps and plenty of volume punch—like driving a classic sports car with the top down. It oozes pure guitar tone, from syrupy tweed rhythm to down right massive crunch, inherited from classic vintage amps and hand crafted boutiques.

Easing in alongside all that heritage is an innovative Two Amps at Once capability to mix and match those legendary amp sounds in a truly decadent array of new tone combinations. Toss in Line 6's signature A.I.R. II direct outs, and you know that this inspiring tone will always be delivered to its destination without compromise or complication. So you're always assured of tone, volume, simplicity, and style...

Flip the page, you lucky devil. And let's take this baby for a spin!

WORKING IT

In a rush? Well, then, just read this page and come back to the rest later:

Quick Start Guide

SPEAKERS, POWER: If you've got a Duoverb HD, hook up your speakers (details are on **Connecting External Speakers** on page 2•9). Connect the power cord from Duoverb's rear panel to your power outlet. *But don't turn the power on yet.*

FOOT CONTROLLER: Connect the included Amp I – II switch to Duoverb's rear panel. If you've got a Line 6 FBV class foot controller, connect it to the rear panel (the older Line 6 Floor Board and FB4 do *not* work with Duoverb).

PLUG IN: Jack your guitar into Duoverb's INPUT. Turn Duoverb's MASTER knob (on the far right) all the way down. Flick Duoverb's POWER switch on. Spin MASTER VOLUME up to 8 o'clock or so. Get ready for tasty tones...

AMP 1 and/or **AMP 2:** Use the toggle switch labeled Amp 1 on top and Amp 2 on the bottom to select Amp 1, Amp 2 or—to get doubly-delicious—both at the same time. If only one amp light is lit, push the toggle switch in that direction to run both amps at once. Push the toggle switch towards the unlit amp light if you only want to run the *other* amp. See **Amp I & Amp II Foot Switch** on page 2•4 for foot switch details.

AMP TONE KNOBS: What you see is what you get here—turn knobs 'til things sound good! The top row of knobs controls Amp 1 and the bottom row controls Amp 2.

BLEND or SPLIT: Flick the switch up to have Amp 1 & 2 *blended* so both amps feed both speakers, or flick it down to have the amps *split* so Amp 1 comes from the left speaker only, and amp 2 from the right only.

CHANNEL MEMORIES: These are like the buttons on a car radio that remember your favorite stations. Press A, B, C or D to recall one of the 4 Channel Memories. Press the button again to get back to “manual mode.” You are in manual mode if none of the A,B,C,D buttons are lit. As on a car radio, hold any of the buttons for 3 seconds to save your current settings to that memory for later recall.

Front Panel Features

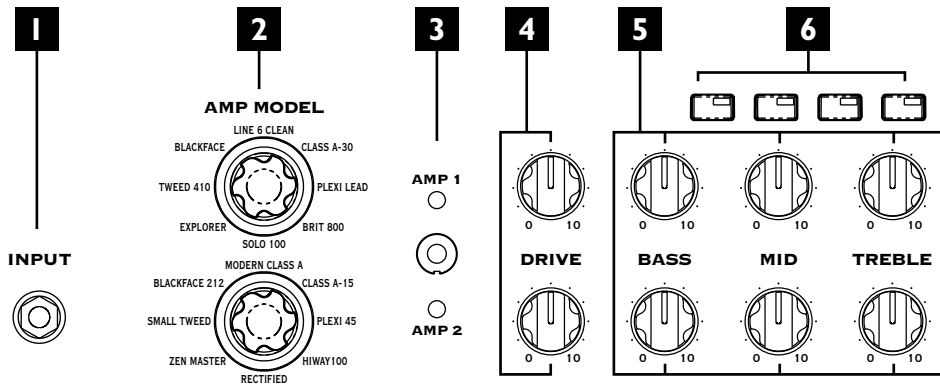

2•2

1. **Guitar Input:** Plug your guitar in here.
2. **Amp Models:** When you spin one of these knobs, it's like swapping the electronic "circuitry" running inside the Duoverb to make your amp sound (see **Chapter 3** for descriptions of the Amp Models). The knob on top selects AMP 1 and the one on bottom selects AMP 2.
3. **Amp 1 – 2 Switch:** Selects Amp 1, Amp 2 or both. If only one amp light is lit, push the toggle switch in that direction to run both amps at once. Push the toggle switch towards the unlit amp light if you only want to run the *other* amp.
4. **Drive:** Turn these knobs to set how hard you're driving the chosen amp model. Similar to the input volume control on a non-master volume amp, the higher the setting, the more "dirt."
5. **Tone Controls – Bass, Mid, Treble and Presence:** These controls are made to behave like the controls of the amps that were modeled for Duoverb. Twist 'em about until things sound just the way you like. See **Chapter 3** for details.
6. **Channel Select Buttons – A, B, C, D:** Duoverb uses these buttons to remember your favorite settings—no more need to mark up the front of your amp with grease pencil to note your favorite settings! Each memory is pre-set with delicious tone when a Duoverb leaves the factory—press a button to hear the saved setting. As you do, notice that Duoverb's lights indicate which Amp Models are used in the channel memory, which amps are on, etc. To get back to the "manual mode," just press the lit button again to turn it off. Plus...

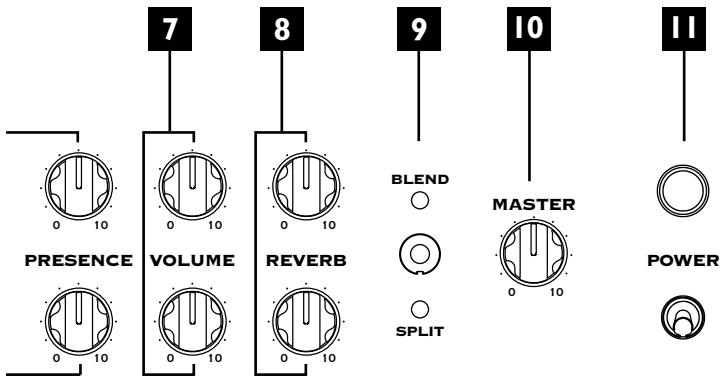

As you come across your own favorite settings that you'd like to keep, you can save them to the A, B, C and D buttons to replace the factory presets. Just hold down any of A, B, C or D buttons for about 3 seconds until all of them flash and presto—Duoverb has now memorized your custom tone for easy recall! See **Using The Channel Memories** on page 2•5 for more detail. The Line 6 FBV class foot controllers let you select these channel memories with your feet—and expand the total number of memories available to a total of 36. **Chapter 4** has got the details.

7. **Amp Volume:** Use these knobs to balance levels between Amp 1 and Amp 2.
8. **Reverb:** You get to decide how much of Duoverb's luxurious model of spring reverb each amp gets. Use just a little to subtly add ambience, or crank up for vintage spring reverb style sproi-oi-oi-oi-ing!
9. **Blend - Split Switch:** Flick the switch up to have Amp 1 & 2 *blended* so both amps feed both speakers, or flick it down to have the amps *split* so Amp 1 comes from the left speaker only, and amp 2 from the right only. **Note:** Duoverb will remember the **SPLIT/BLEND** combinations for both single amp configurations and dual amp configurations when you save a channel. This control is here because we've found that running two amps in SPLIT mode can sound *huge*. When running a single amp, you'll probably want BLEND mode, so sound is coming through both speakers.
10. **Master:** Sets the overall volume of your Duoverb. Spin this to set your basic loudness, then use the amp Volume knobs to balance the levels between Amp 1 and Amp 2, as well as the relative volume of the sounds you store with the A, B, C, D buttons.
11. **Power Switch:** Flip the big metal switch to apply power to the dilithium crystal mounted on the front panel above it.

Amp I & Amp II Foot Switch

2•4

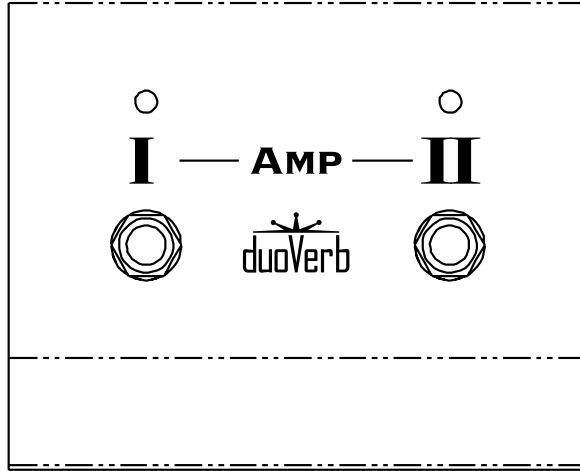

The included Amp I – II foot switch connects to Duoverb’s rear panel, letting you control which amp(s) are on with your feet. The lights on the pedal show which amp(s) are currently on. It all works like this:

1. To turn on Amp 1, step on switch I, and its light will come on.
2. To select Amp 2, step on switch II, and its light will come on.
3. To turn on both amps, just step on the switch for the amp that's already on. For example, if Amp 1 is on and you want to get both amps on, step on switch I again. The I and II lights will now both be lit.
4. If both amps are on, and you would like to go back to a single amp, press the footswitch for the amp you'd like to keep on. For example, while both amps are on, step on the I switch, and now only Amp 1 will be on.

Manual Mode: What You See Is What You Get

When *none* of the **A, B, C, D Buttons** are lit, Duoverb is operating in **Manual Mode**, meaning that all of the controls are active and the sound of the amp is determined by the current knob settings. Just like pretty much any other amplifier, right?

If you are not in **Manual Mode** and would like to be, simply give the lit **A, B, C, or D Button** a quick press.

Using The Channel Memories

Duoverb can store and recall your favorite settings using the **A, B, C, D Buttons**.

Save: Any time you've dialed up a sound that you'd like to save for later recall, all you have to do is hold down button **A, B, C** or **D** for 3 seconds. At the end of that 3 seconds, the button you held will flash to let you know that you've successfully stored your present setting of all the controls to that button. Now you can carry on tweaking away to make other sounds, and when you're ready to go back to that perfect one you just saved, just tap the button again....

Recall: When you tap one of the **A, B, C, D Buttons** to light it up, Duoverb recalls the settings that were stored in that button's Channel memory. This will affect basically everything except the **Master** volume, including choice of **Amp Models**, the on/off state of **Amp 1** and **Amp 2**, the **Drive, Bass, Mid, Treble, Presence, Volume** settings for both amps and the **Blend/Split** option.

The various front panel lights will show the recalled settings, but the knobs will not. Turning any knob or operating any switch will override the recalled setting for that control only. To override all the recalled settings and get the sound determined by the current setting of all the knobs, press the lit **A, B, C, D Button**. You're now back in What-You-See-Is-What-You-Get **Manual Mode**.

See **Chapter 4** for details on how to store and recall a total of 36 Duoverb Channel Memories using your feet.

To reset all the Channel Memories (including all 36 available from an FBV) to their factory state, hold the **A** and **D Buttons** while powering up Duoverb.

Rear Panel Features

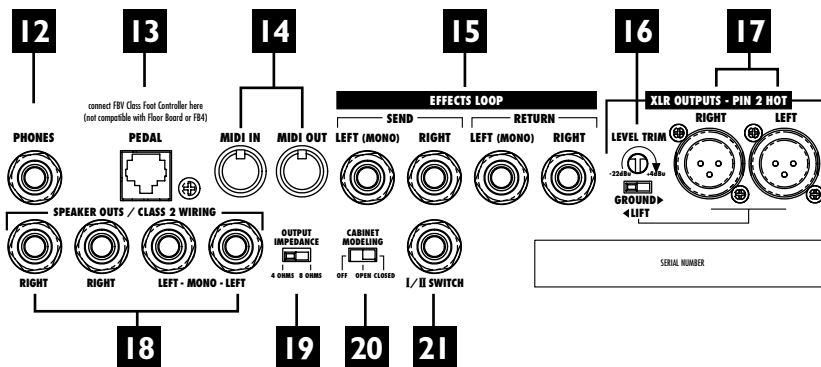

- 12. Phones:** Keep it quiet around the house by connecting headphones to the **Phones** jack. Just remember to unplug your headphones when you want to rock the house again—plugging in headphones disables your speaker outputs. The **Master** knob sets the output level while you're using headphones—be sure you turn the knob down as you switch between headphones and the speakers to make sure you don't unexpectedly blast yourself with volume.
- 13. Pedal:** Connect the RJ-45 cable supplied with your FBV or FBV Shortboard here. **Chapter 4** has the full details.
- 14. MIDI In & MIDI Out:** Connect standard MIDI cables here. Duoverb always sends and receives on MIDI Channel 1. See the MIDI appendix for more details.
- 15. Effects Loop:** Use the Left(Mono) Send and Return for a mono rack effect. Connect stereo effects as shown below. Generally stompboxes go before the amp, *not* in this loop. When your amps are Split, Amp 1 comes out left only, and Amp 2, right only.

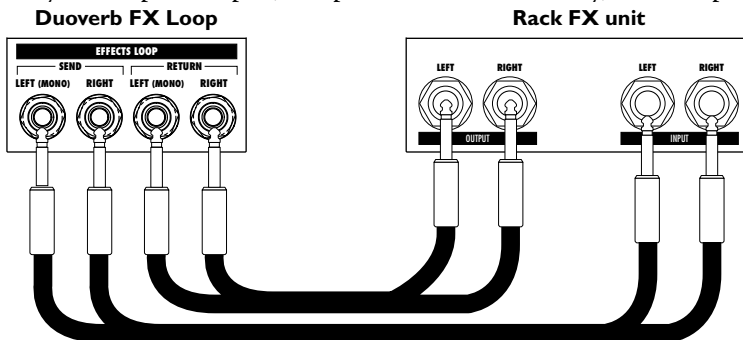

- 16. Level Trim:** The level of the XLR Outputs is set by the small rear panel trim, and is not affected by the **Master** knob.
- 17. XLR Balanced Outputs & Ground Lift:** These versatile connections are designed with Line 6's exclusive A.I.R. II technology to give you the perfect pair of direct connections for live performance and studio recording sessions. See **Using Your Direct XLR Outputs** on page 2•8 for details. Try the Ground Lift switch to break ground loops when you get grounding hum from connections to the other equipment.
- Please Note:** there can be an audible 'pop' on the outputs when powering Duoverb on or off. We recommend that you either disconnect the direct outputs or power down whatever the direct outs are connected to before powering your Duoverb on or off.
- 18. Speaker Outs:** Hook up additional speaker cabinets here (see **Connecting External Speakers** on page 2•9).
- 19. Output Impedance:** It is important to set Duoverb's output impedance to properly match the speakers that you are connecting. When using a combo to run its internal speakers in stereo, set this switch to the 8 ohms position. See **Connecting External Speakers** on page 2•9 for details on other setups, including the HD.
- 20. Cabinet Modeling:** This switch is used to activate Duoverb's Cabinet Modeling Technology (see **Chapter 3**) and properly match it to the type of physical speaker cabinet(s) you are using. The standard setting for the Duoverb combo with its internal speakers or the Duoverb 2x12 open-back extension cabinet is OPEN. If you're running a 4x12 or other closed-back cabinet, use CLOSED.
- 21. I/II Switch:** Plug your included Amp I/II Switch pedal here. See **Amp I & Amp II Foot Switch** on page 2•4 for details on pedal operation.

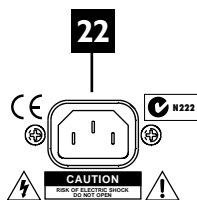

- 22. Power Connector:** Little bitty electrons flow in here to make things work. Connect the supplied power cable to the source of electrons (your wall outlet), then flick the power switch that's on the front of Duoverb to let the electrons in to do their stuff.

Using Your Direct XLR Outputs

2•8

One of the nifty features inside your Duoverb is Line 6's exclusive A.I.R. II technology that enables you to get that great mic sound out of your amplifier without the microphone! Your Direct outputs can be used either in the studio or as a direct feed to the house sound system for a live performance.

The **Master** knob on your Duoverb sets the level for the internal speakers (and any external speakers you connect), without having any effect on your Direct Output level. This is a good thing, for instance, when you're playing live. It means you can set a low volume level for your amp on stage (maybe it's a small venue) while still pumping out full level at the direct outs so the house sound system is getting plenty of juice. And any adjustments you make to your on stage level during the gig don't send the soundman scrambling to compensate on his end. This is also a good thing if you're recording in the studio, using your amp to monitor with the other band members while your direct out is being recorded. Once again, an appropriately low master volume level that you might want for the amp doesn't force you to have a low level signal going to tape, and adjustments you make to your level don't interfere with the levels in the control room.

Duoverb can pump out enough direct out level to light up the input meters for +4 dBu pro recording. For live sound systems, as well as many recording setups designed to work with lower levels, this can sometimes be overkill. The **Level Trim** knob on Duoverb's rear panel lets you roll back the direct out level and keep your sound guy or lower-level recording system happy.

If you're setting the levels yourself, and want to make sure you don't overdo it, you can follow these basic steps. First, plug the hottest output level guitar you plan to use into Duoverb, switch to your hottest pickup setting, and crank the guitar's output volume (or put it as high as you ever set it). If you plan to change sounds on your Duoverb during the gig, start by selecting the Duoverb settings that seems to have the loudest output level. You can set your **Master** knob on Duoverb low as you do all this so you don't blow yourself out; it won't affect the direct output level. Now, with this guitar and Duoverb setup, play hard (so you're sending maximum volume out those direct outputs) and have someone adjust Duoverb's rear panel **Level Trim** knob until a good healthy level is being received by the equipment you're sending sound to. The level shouldn't be so hot that it's causing input distortion on that receiving equipment. If the receiving equipment has an input level adjustment, you'll probably get your best signal-to-noise ratio by setting it as low as possible while setting Duoverb's **Level Trim** as high as possible.

Connecting External Speakers

The following pages illustrate how to connect your Duoverb to Line 6 speaker cabinets. If you are using any other cabinets be sure to check your speaker cabinets' impedance and choose the matching setting on your Duoverb's rear panel impedance switch. In correct settings will give you less volume than you'd expect, or cause Duoverb to shutdown its power amps after a while to protect them from overheating—if you are uncertain about the settings to use with your setup, please consult an expert.

Hooking up your Combo in stereo to a single Duoverb 2x12 Cabinet

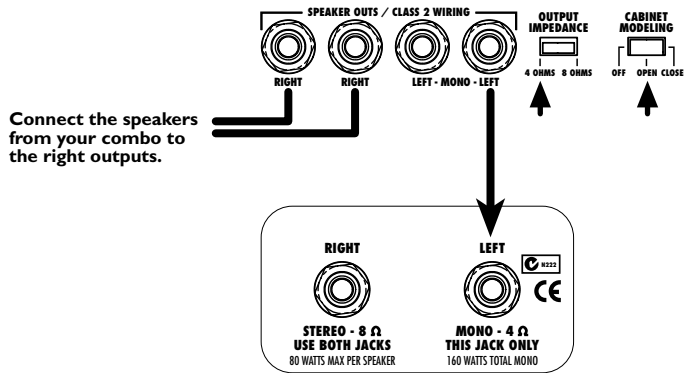

Hooking up your HD in stereo to a single closed back 2x12 cabinet

*If you are using an open back cabinet such as the Duoverb Extension Cabinet select **OPEN** CABINET MODELING.

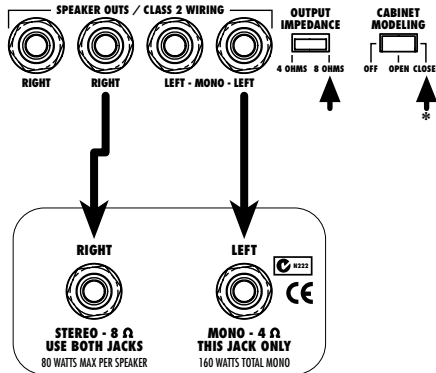

Hooking up your HD in mono with a single 4x12

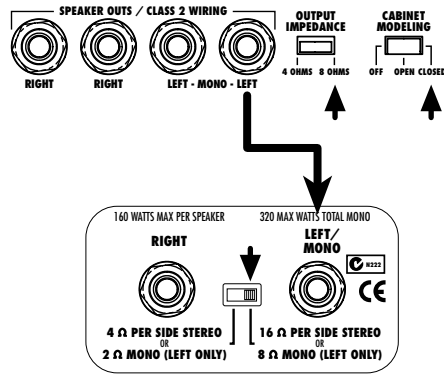

Hooking up your HD in stereo with a single 4x12

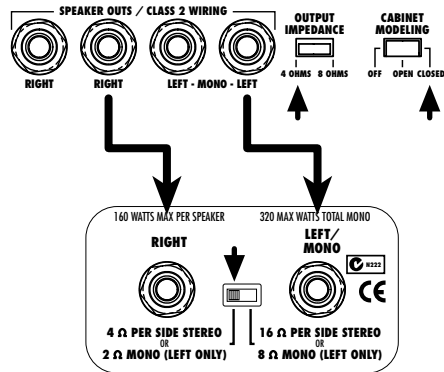

Hooking up your HD in side by side stereo with two 4x12s

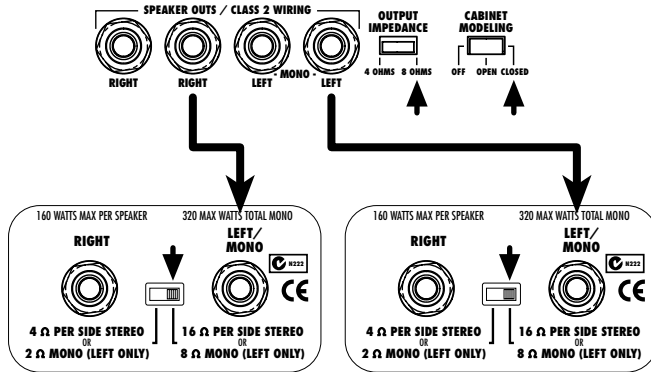

Hooking up your HD in stacked stereo with two 4x12s

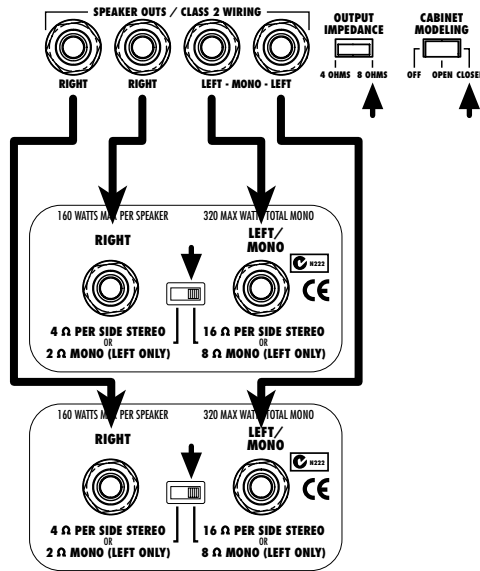

Hooking up your HD in side by side stereo with two 2x12s

*If you are using an open back cabinet such as the Duoverb Extension Cabinet select **OPEN** CABINET MODELING.

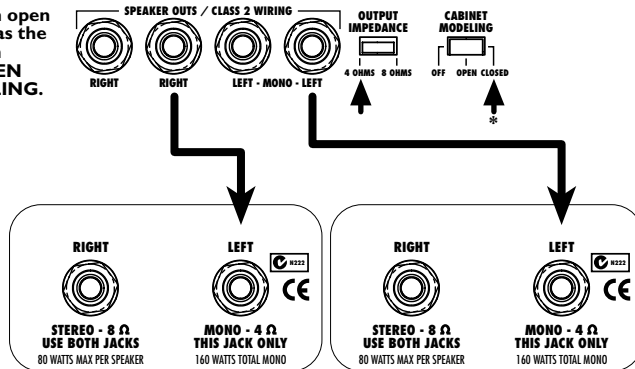

Hooking up your HD in stacked stereo with two 2x12s

*If you are using an open back cabinet such as the Duoverb Extension Cabinet select **OPEN** CABINET MODELING.

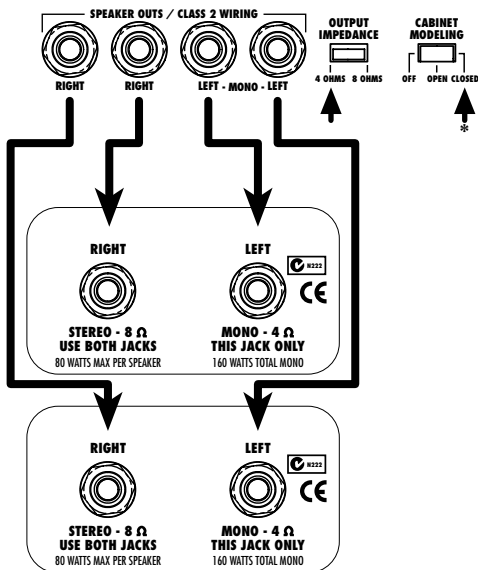

THE AMPS & CABS

Duoverb's heart is its collection of Amp and Cab Models—resulting from Line 6's meticulous study of a dream collection of vintage and modern amplifiers and cabinets. Each position of Duoverb's **Amp Model** knobs calls up a particular Amp/Cab combination, powered by the same coveted models as the Line 6 Vetta series amps.

3 • 1

Meet The Family

Once we've set our sights on creating a software emulation of a particular kind of amp or cabinet here at Line 6, the first step is to get our hands on the very best example that we can find to study. We will (and have) scoured the globe in search of just the right specimen—that one, very particular unit that has *the magic*.

After all, amps from '57, '62, '65, '67, '75, and 2002 may all bear the same model name, yet have totally different circuit designs, sound and response—and quite often a different look as well. Even two amps with the same circuit design, from the same era, can sound radically different, just on the basis of variance in component tolerances, as well as how the wiring harness was dressed—and maybe even what the amp assembler had for lunch that day. Plus there's the fact that every amp has its own special way of settling in over the years and, just like people, some of them only get better with age.

Each of the distinguished amps and cabs that we select for modeling thus has a character and specialness as uniquely individual as a treasured friend. And we've included photos here of the actual amps that we selected, studied and measured so that you'll know *exactly* which amp we're talking about.

So, let's meet the Amp and Cab Models that live inside your Duoverb, and the original equipment that helped to make them possible. We'll start with the Explorer on the upper **Amp Model** knob, go completely around the knob to the Solo 100, then start with the Zen Master on the lower knob and work our way around again to Rectified.

Explorer – based on a 1960 Gibson Explorer



This Amp Model is based on a 1960 Gibson Model GA-18T Explorer (little brother to the Gibson “Les Paul” GA40T).

The particular amp we modeled originally belonged to the father of one of the high school buddies of Line 6’s Artist Relations guru, Tim Godwin. It was sitting in a crawlspace for years, until Tim happened to ask his friend if he still had the amp, and whether he was interested in selling it. When Tim finally got his hands on it, the amp still had the original Gibson branded tubes in it!

Some time passed, and Tim brought his little treasure into the office one day. Once a few of us played through it, we cried out as one voice, “We’ve got to model this one!”

Working from codes found on the pots and speaker, we were able to date this amp’s build to the week of May 21, 1960. 14 watts, with a 10-inch Jensen speaker, the amp runs Class A with 6SJ7 preamp tubes, 6V6 Power tubes, and a 5Y3 rectifier—just in case you were interested.

The Cabinet Model is based on the Gibson and its 10-inch Jensen Blue Bell.

All product names are trademarks of their respective owners, which are in no way associated or affiliated with Line 6. These product names, descriptions and images are provided for the sole purpose of identifying the specific products that were studied during Line 6’s sound model development.

Tweed 410 – based on a 1958 Fender Tweed Bassman



3 • 3

The classic '58 Fender Bassman 4x10 combo was the amp that started it all—instant rock and roll tone. Originally a bass guitar amp, the Bassman became a Blues staple for 6-string guitarists thanks to its fat bottom end and the Fender twang on the top.

An interesting thing about the Bassman—and Duoverb's Tweed 410 model—is just how interactive the Mid and Treble controls are. The Mid control isn't a bandpass, as in most tone control setups. Instead, it's almost like a second treble control. The two are additive, so if you're running the Mid knob higher than halfway up, you'll find the Treble control might give you more bright than you really want. On the other hand, when you turn the Mid knob down, you'll probably want to boost the Treble.

The Bassman, like many of the amps modeled by Duoverb, didn't have a master volume, and you had to really crank it up to get the great tone it delivers at high volume. With Duoverb, you can get that kind of tone at a bedroom or studio level—or through your headphones even—by cranking up the Drive knob. Give your best R&B licks a try with Drive set to about 4 or 5.

The Cabinet Model is based on the Bassman loaded with four 10-inch Jensen speakers.

All product names are trademarks of their respective owners, which are in no way associated or affiliated with Line 6. These product names, descriptions and images are provided for the sole purpose of identifying the specific products that were studied during Line 6's sound model development.

Blackface – based on a 1964 Fender Deluxe Reverb



3 • 4

The Holy Grail for many blues, country, and “roots” players has been a blackface Fender Deluxe Reverb. The particular amp we studied for modeling was built in 1964, and is truly one of the finest examples of what a Deluxe Reverb can be.

Most players love a Deluxe when it’s turned up to about 7 for a nice gritty sound that cleans up when you back off your guitar’s volume knob just a little. Notice how the tone control response changes as this Amp Model’s Drive is changed: clean settings are crisp and present, while more driven settings will mellow the high end. This is typical of what you get from a Deluxe and is nicely captured here.

The Deluxe itself has only Bass and Treble controls. The Mid knob of Duoverb’s Blackface model lets you add some post-Amp Model midrange contouring when you want to expand on the Deluxe Reverb’s capabilities for a little more flexibility. And Presence adds, well, Presence. Set the Mid knob to its 12 o’clock position and the Presence knob to 0 for the classic Deluxe sound. Tweaked up right, this tone will cut through and sing.

The Cabinet Model is based on the Deluxe, which is loaded with one 12-inch Jensen.

All product names are trademarks of their respective owners, which are in no way associated or affiliated with Line 6. These product names, descriptions and images are provided for the sole purpose of identifying the specific products that were studied during Line 6’s sound model development.

Line 6 Clean



3 • 5

Now, that amp sure looks familiar.... In fact, this model is a unique sound that you'll only find in Duoverb and Line 6's other amp modeling equipment.

To create this Amp Model, we essentially grafted the preamp and tone stack of Roland's popular JC-120 "Jazz Chorus" solid state combo onto the poweramp and transformer of a classic Marshall JTM-45 tube head. The model that resulted brings you the crisp and clear front end typical of a solid state amp plus a rich, satisfying tube amp-style bite as you turn it up. Welcome to the best of both worlds.

The Cabinet Model is a custom Line 6 2x12 creation.

All product names are trademarks of their respective owners, which are in no way associated or affiliated with Line 6. These product names, descriptions and images are provided for the sole purpose of identifying the specific products that were studied during Line 6's sound model development.

Class A-30 – based on a 1967 Vox AC-30 Top Boost



Music was changing in the early '60s and guitarists were asking for more brilliance & twang. So the Jennings Company, makers of Vox amps, decided to add Treble and Bass controls (and an extra 12AX7 gain stage, incidentally) in addition to the Treble Cut knob it already had (which in actuality was a sliding bandpass filter); this additional circuit became known as Top Boost.

The AC 30 with Top Boost was the amp made famous by many British invasion bands. Much of the unique character of the Vox sound can be attributed to the Class A circuitry—Class A amps overdrive in a very different way than Class AB. Brian May of Queen, Mike Campbell of Tom Petty's Heartbreakers, and The Edge of U2 have all used classic AC 30s to make their music. Although often played fairly clean, a cranked AC 30 has a great saturated lead tone, a la Brian May on early Queen albums.

On this Amp Model, Duoverb's Mid control acts like the original Cut knob on the AC 30. We also turned the Bass and Treble controls around, unlike the design of the Top Boost electronics, which has the bass and treble turned all the way *down* when the knob was all the way *up*. Go figure.

The Cabinet Model is based on the Vox and its two 12-inch Celestion Bulldogs.

All product names are trademarks of their respective owners, which are in no way associated or affiliated with Line 6. These product names, descriptions and images are provided for the sole purpose of identifying the specific products that were studied during Line 6's sound model development.

Plexi Lead - based on a 1968 Marshall Super Lead



3 • 7

We literally scoured the world for this particular amp, finally finding a great example of a Super Lead languishing (we like to think fate preserved it for us) in Holland. One of the fun things you can do with a Plexi is take a short guitar cable and jumper channel I and channel II (as they're frequently numbered) together for a little extra saturation. Some guys loved this sound so much that they pulled the chassis and permanently wired a jumper into the amp. We modeled the Super Lead this way.



Hendrix used a Super Lead with the 'lay down' transformer unique to the '68 models, and Van Halen's first two records also owed their "brown sound" to a '68 Plexi. To get a nice crunch sound out of a Plexi, you crank all the volume and tone controls to 10. In keeping with our "make-it-sound-a-whole-lot-like-the-original" concept, diming all your knobs with Duoverb's Plexi Lead gets you pretty darned near the same thing.

The Cabinet Model is based on a perfectly-seasoned '68 Marshall 4x12 basketweave cabinet with its Celestion Greenback 25's.

All product names are trademarks of their respective owners, which are in no way associated or affiliated with Line 6. These product names, descriptions and images are provided for the sole purpose of identifying the specific products that were studied during Line 6's sound model development.

Brit 800 – based on a 1987 Marshall JCM 800

3 • 8



Turn to this Amp Model to conjure up tones of the coveted JCM 800, one of Marshall's most universally-acclaimed modern amps. This updated version of the Plexi continued Marshall's heritage with added gain and edge for a new generation of rock guitarists. One of the biggest differences here is that the tone controls are located after the preamp tubes, giving them more tone-sculpting effect at high gain settings. Some versions of the JCM 800, by the way, get their distortion by clipping a diode. The amp we modeled uses a tube for distortion.

The JCM 800 is, of course, the metal sound Marshall made famous. And although not many people play Marshalls clean, it is a great tone, so you should also be sure to check out this model with a low Drive setting. Of course, you can always pump up the drive and rage....

The Cabinet Model is based on a Marshall 4x12 loaded with Celestion Vintage 30's.

All product names are trademarks of their respective owners, which are in no way associated or affiliated with Line 6. These product names, descriptions and images are provided for the sole purpose of identifying the specific products that were studied during Line 6's sound model development.

Solo 100 – based on a Soldano SLO-100



3 • 9

This model is based on a Soldano SLO-100 head.

Mike Soldano first came to fame as the guy who could do all the really cool mods to your Marshall. It wasn't long before he started building his own 'hot-rod' amps—sporting chromed transformers and chassis, no less. Mike's amps are also famous for their bullet-proof construction and military spec wiring and components.

While primarily known for its high gain personality, the SLO-100 has a great clean tone as well. Eric Clapton put Soldano on the map when he played "Saturday Night Live" with his Soldano SLO-100.

The Cabinet model is based on a Soldano 4x12 loaded with Celestion Vintage 30's.

All product names are trademarks of their respective owners, which are in no way associated or affiliated with Line 6. These product names, descriptions and images are provided for the sole purpose of identifying the specific products that were studied during Line 6's sound model development.

Zen Master – based on a 2001 Budda Twinmaster

3 • 10



This model is based on a Budda Twinmaster 2x12 combo. The Budda has a great, warm, Class A/B, sound. The Budda philosophy is all about power tube distortion. Simplicity is the key. With relatively low front end gain, highly interactive tone controls, and tube rectifier “sag,” it’s great at getting a classic cranked sound for small gigs and recording (it’s all of 18 watts).

Since the original Twinmaster has no mid control, we’ve added a little bonus to our model in the form of some post-Amp Model mid contouring available via Duoverb’s Mid control. Set this control to 12 o’clock to get groovy with the unadorned Budda-style vibe. The Presence knob is also an “extra”—set it to 0 for no added Presence.

The Cabinet Model is based on the Twinmaster and its two 12-inch Mojotones.

All product names are trademarks of their respective owners, which are in no way associated or affiliated with Line 6. These product names, descriptions and images are provided for the sole purpose of identifying the specific products that were studied during Line 6’s sound model development.

Small Tweed – based on a 1953 Fender Tweed Deluxe



3 • 11

Modeled after a 1953 “wide panel” Fender Tweed Deluxe, this Amp Model will snarl with the best of them. The original amp had only a single tone control, essentially a Treble roll off. We set up Duoverb’s Treble knob to give you this roll off when using this Amp Model.

Which left us with the Bass and Mid knobs just sitting there. So we set up the Bass and Mid as post-Amp Model controls, which essentially lets you EQ up your tone as you would do on a mixing console after recording your amp. For a classic Tweed sound, try the Treble knob somewhere above halfway, set the Bass and Mid knobs at halfway to put them in “neutral,” and turn the Presence to 0 for no extra Presence.

The Cabinet Model is based on the Tweed Deluxe with its single 12-inch Jensen.

All product names are trademarks of their respective owners, which are in no way associated or affiliated with Line 6. These product names, descriptions and images are provided for the sole purpose of identifying the specific products that were studied during Line 6’s sound model development.

Blackface 212 – based on a 1965 Fender Twin Reverb

3 • 12



The classic blackface Fender Twin (in this case, a 1965 Twin) was a real workhorse. Everybody used it, from jazz and country players to serious rockers. I myself remember seeing Johnny Winter at a concert where both he and Rick Derringer—am I dating myself or what?—were using six Twins stacked in a pyramid. Each. We were in the second balcony and it was REALLY loud even all the way back there. The Twin has a lot of tonal flexibility and is at home in a great many different situations. It never gets extremely overdriven and dirty, mostly just louder—a lot louder.

With Duoverb's killer spring reverb model, this is a great choice for the classic surf sound. Goose the reverb, crank up the volume, and get ready to party with Annette Funicello and the rest of the gang!

The Cabinet Model is based on the Twin with its 12-inch Jensen speakers.

All product names are trademarks of their respective owners, which are in no way associated or affiliated with Line 6. These product names, descriptions and images are provided for the sole purpose of identifying the specific products that were studied during Line 6's sound model development.

Modern Class A – based on a Matchless DC-30



3 • 13

This model is based on a Matchless DC-30.

The DC-30 was the amp that really put Matchless on the map. Mark Sampson, the amp's designer, who was kind enough to tell us the story behind this great amp's design personally, set out to create a road-worthy Class A amp that had the versatility to cover a wide range of tones.

Built like a tank (and weighing nearly as much), the DC-30 paid tribute to early Vox amps, so if you like a Vox AC-30 (or Duoverb's Class A-30 model based on one), you'll also want to check out this model.

The Cabinet Model is based on the DC-30 with its pair of 12-inch Celestion Custom Design speakers.

All product names are trademarks of their respective owners, which are in no way associated or affiliated with Line 6. These product names, descriptions and images are provided for the sole purpose of identifying the specific products that were studied during Line 6's sound model development.

Class A-15 – based on a 1961 Vox AC-15

3 • 14



This model is based on a wonderful 1961 Vox AC-15. The sound is similar to the Vox AC-30 that was the inspiration for the Class A-30 model, but this is a smaller amp (only one 12-inch speaker instead of two) with a warmer, more “woody” sound.

Once again, the original amp had only a single tone control—a treble cut. We faithfully modeled that and then slipped in some post-Amp Model Bass and Mid contouring. Set Bass and Mid in neutral (which is 12 o’clock, or halfway up), Presence to 0, and play with the Treble control to get yourself some of those classic British invasion sounds.

The Cabinet Model is based on an AC-15 loaded with one 12-inch Celestion Bulldog.

All product names are trademarks of their respective owners, which are in no way associated or affiliated with Line 6. These product names, descriptions and images are provided for the sole purpose of identifying the specific products that were studied during Line 6’s sound model development.

Plexi 45 – based on a 1965 Marshall JTM-45



3 • 15

When the royal agents that we had dispatched to the UK found this particular amp, we instantly fell in love. The amp even has the original KT-66 tubes in it, still in great shape! It's one of the finest examples of a JTM-45 we've ever heard, and it's a constant battle at Line 6 to see who gets to take it home for the weekend.

Those interested in the genealogy of tone will be interested to note that the JTM-45 marked the beginning of Marshall's transition from a mellower Fender-like tone to the distinctive, bright "crunchy" sound of the later Marshalls.

The Cabinet Model is based on a '67 Marshall 4x12 loaded with 12-inch Celestion Greenback 20's.

All product names are trademarks of their respective owners, which are in no way associated or affiliated with Line 6. These product names, descriptions and images are provided for the sole purpose of identifying the specific products that were studied during Line 6's sound model development.

Hiway 100 – based on a Hiwatt 1973 Custom 100

3 • 16



Based on a Hiwatt DR-103, this model gives a great, punchy sound that will cut through almost anything and retains great definition even when cranked. That's exactly what designer Dave Reeves was looking for when he left the Sound City division of Dallas Arbiter in 1966 to form HyLight Electronics. Though his first designs were more reminiscent of the Vox and Selmer amps of the day, it wasn't long before Reeves had started producing the amps that '60s Brit-Rock fans have become familiar with. Renowned for their 'tank-like' construction (due in part to Reeves' hiring of 'mil-spec' wiring specialist Harry Joyce), it was small wonder this amp was the choice of Pete Townshend for so many years. In fact, many of the then-current crop of British rockers like Pink Floyd, The Moody Blues, Manfred Mann, and Jethro Tull were also Hiwatt endorsees. Crank this one up and you can see for miles.

The Cabinet Model is based on a Hiwatt 4x12 loaded with 12-inch Fanes.

All product names are trademarks of their respective owners, which are in no way associated or affiliated with Line 6. These product names, descriptions and images are provided for the sole purpose of identifying the specific products that were studied during Line 6's sound model development.

Rectified – based on a 2001 Mesa Boogie Dual Rectifier



3 • 17

This Amp Model is based on a 2001 Mesa Boogie Dual Rectifier Solo Head.

The Dual Rectifier was part of Boogie's more modern, high gain approach. In contrast to the earlier Boogies, the Dual Rectifier's tone controls have more influence at high gain settings, so you can scoop the mids and increase the bottom end. This is a great model to try if you're looking for the aggressively high gain sound of much of today's modern rock.

The Cabinet Model is based on a Mesa Boogie 4x12 loaded with 12-inch Custom Design Speakers.

All product names are trademarks of their respective owners, which are in no way associated or affiliated with Line 6. These product names, descriptions and images are provided for the sole purpose of identifying the specific products that were studied during Line 6's sound model development.

USING YOUR FEET

FBV Class Foot Controllers

If you find that your Amp I – II switcher pedal is just not enough, have no fear—the FBV is here! Using an FBV series foot controller gives you Wah and Volume pedal control plus the ability to name, store and recall 36 Duoverb Channel Memories.

The FBV series of foot controllers includes the original FBV—with its extensive effects controls for the Line 6 Vetta amps—and the more-compact FBV Shortboard, which includes all the controls needed for the Duoverb. The Shortboard comes with a sticker that relabels some of the controls that are used for non-Duoverb functions on other Line 6 products. We'll assume you've got that in place as we describe the Shortboard's functions here.

Note that the Line 6 Floor Board and FB4 foot controllers will not work with Duoverb.

Connecting an FBV

Your FBV comes with an included RJ-45 cable. Connect this cable between the rear panel of the Duoverb and the rear panel of the FBV. The cable supplies power as well as communication, so there's no separate power supply required for the pedal.

If you ever need a replacement cable, look for a **Category 5, 10 Base-T or RJ-45 cable with male connectors on both ends.**

- “Category 5” refers to a 1 to 5 grading system for cable quality, with 5 being the highest quality. Get the good one.
- “10 Base-T” is a kind of computer network that uses these same cables.
- “RJ-45” is what you call the connectors on the ends of the cable.

If you're unsure if you've got the right thing, note that RJ-45 connectors basically look like a wide version of standard US telephone line connectors, with eight contacts instead of four.

So What Do All These Buttons and Pedals Do?

4 • 2

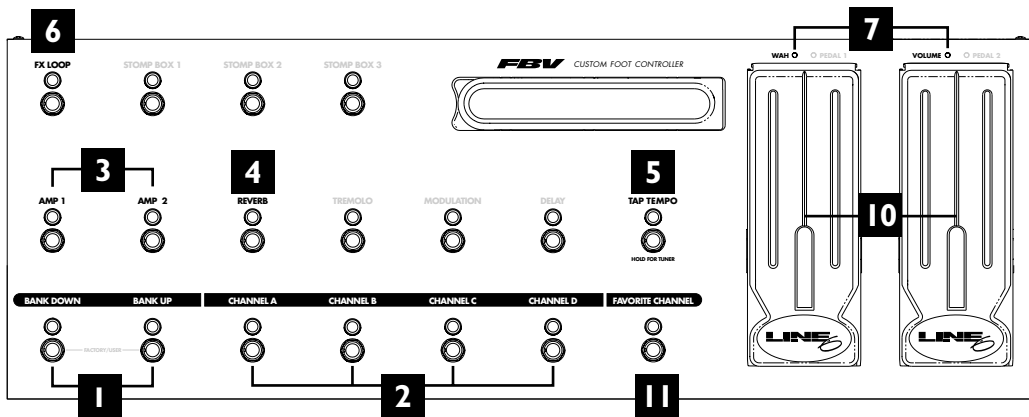
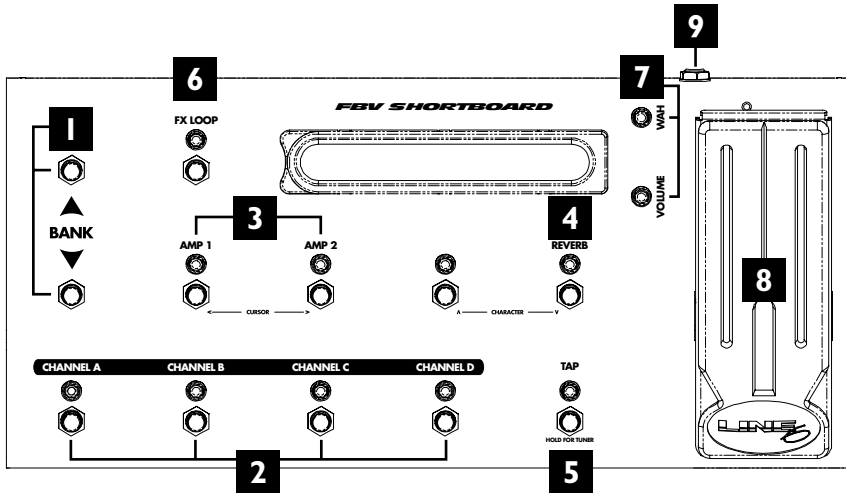

1. **Bank Up - Bank Down:** Use these two switches to choose any of the 9 Banks of Duoverb Channel Memories. Bank 1 is the same four memories you get from the front panel **A, B, C, D Buttons** when no FBV is connected.
2. **Channel A, B, C & D:** Select from the four Channel Memories in the current Bank.

3. **Amp 1 - Amp 2:** (*Shortboard owners, apply the included sticker to label these controls.*) When one amp is on, kick the *other* amp's switch to turn that other amp on instead. Or when one amp is on, kick that amp's switch to turn *both* amps on. And if both amps are on, kick either switch to switch to having only that amp on.
 4. **Reverb:** Switches Duoverb's reverb on and off.
 5. **Tuner:** Press and hold this switch until you see the tuner on the pedal's display. Press it again to exit tuner mode.
 6. **FX Loop:** Turns Duoverb's Effects Loop on or off.
 7. **Wah and Volume Lights:** Show that a pedal is ready to control Wah or Volume.
 8. **FBV Shortboard Pedal:** Press a pedal fully forward to click the toe-switch, switching the pedal to control Wah or Volume. If a separate expression pedal is connected to the Shortboard's rear panel 1/4-inch jack, the Shortboard pedal controls Wah only, with the toe switch toggling the Wah on/off.
 9. **External Pedal Jack:** You can connect an expression pedal (such as the Line 6 EX-1) to the Shortboard's rear panel 1/4-inch jack. The connected pedal will control Volume, while the Shortboard pedal controls Wah only.
 10. **FBV Pedals:** Press a pedal forward to click the toe-switch, turning the pedal on/off.
 11. **Favorite Channel (FBV only):** Recalls a channel of your choice no matter what bank you are currently using. To make a channel your favorite, select that channel, then press and hold the favorite switch until the display shows "**SAVING**"—that's it!
- Note:** Any switches not being used by your Duoverb do send MIDI messages and can be used to control other devices. See the MIDI Appendix for details.

Flip the page for details on saving and naming your Duoverb sounds with your FBV....

Saving and Naming with an FBV

To prepare for saving, it's a good idea to browse through the various factory-stored preset sounds to decide which you can do without. Make a note of their Bank number and Channel letter so you can save your own sounds there instead.

1. **Save:** Step on the **FX LOOP** switch until **"NAME EDIT"** is displayed.
2. **FBV SHORTBOARD users - Name:** The Shortboard's **Amp 1** and **Amp 2** switches (labeled **Cursor** in small text) select one of the characters of the channel name so you can edit it. The **DELAY** and **REVERB** switches (labeled **Character** in small text) choose from the available letters, numbers and symbols. Once you've got a name you're happy with, jump ahead to step 3.
2. **FBV Users - Name:** The **REVERB** and **TREMOLO** switches select which character of the channel name you would like to edit. The **MODULATION** and **DELAY** switches choose from the available letters, numbers and symbols. Once you've got a name you're happy with...
3. **Pick a Bank:** **Bank Up** and **Bank Down** switches pick a Bank you'd like to save to.
4. **Complete the Save:** Press the **A, B, C** or **D** switch to store to that Channel Memory in the chosen Bank. The display will show **"SAVING"**.

Congratulations, you're all done!

APPENDICES

MIDI Capabilities

Duoverb always communicates on MIDI Channel 1. MIDI Program Change messages select Duoverb's Channel Memories or Manual Mode, and are sent by Duoverb to control MIDI effects, etc. A variety of parameters can be controlled via MIDI Continuous Controller messages, as detailed on page 5•2.

MIDI Program Change Values

MIDI Program Change Messages 0-36 can be used to select Duoverb's Channel Memories or Manual Mode:

MIDI Program Change	Duoverb Channel Memory
0	Manual Mode
1	1A
2	1B
3	1C
4	1D
5	2A
6	2B
7	2C
8	2D
9	3A
10	3B
11	3C
12	3D
13	4A
14	4B
15	4C
16	4D
17	5A
18	5B
19	5C
20	5D

MIDI Program Change	Duoverb Channel Memory
21	6A
22	6B
23	6C
24	6D
25	7A
26	7B
27	7C
28	7D
29	8A
30	8B
31	8C
32	8D
33	9A
34	9B
35	9C
36	9D

MIDI Continuous Control Messaging (Part I)

Amp Parameter	MIDI		MIDI CC Range			Notes
	TX	RX	CC#	Min	Max	
Amp 1 Engage	√	√	111	0	127	0~63=Off ; 64~127=On
Amp 1 Model Select	√ 0-7	√	12	0	15	Knob selects 0~7, Range = 0~15. See list below.
Amp 1 Drive	√	√	13	0	127	
Amp 1 Bass	√	√	14	0	127	
Amp 1 Mid	√	√	15	0	127	
Amp 1 Treble	√	√	16	0	127	
Amp 1 Presence	√	√	21	0	127	
Amp 1 Chan Volume	√	√	17	0	127	
Amp 1 Split/Pan	√	√	10	0	127	Continuous (i.e. 0=left, 64=center, 127=right)
Amp 1 Reverb Send	√	√	18	0	127	
Amp 1 Cabinet Model		√	71	0	16	Amp 1 Knob selects 1~8, Range = 0~15. See list below
Amp 2 Engage	√	√	112	0	127	0~63=Off ; 64~127=On
Amp 2 Model Select	√ 8-15	√	91	0	15	Knob selects 8~15, Range = 0~15. See list below.
Amp 2 Drive	√	√	92	0	127	
Amp 2 Bass	√	√	93	0	127	
Amp 2 Mid	√	√	94	0	127	
Amp 2 Treble	√	√	95	0	127	
Amp 2 Presence	√	√	102	0	127	
Amp 2 Chan Volume	√	√	103	0	127	
Amp 2 Split/Pan	√	√	8	0	127	Same as Amp 1 Split/Pan
Amp 2 Reverb Send	√	√	106	0	127	
Amp 2 Cabinet Model		√	104	0	16	Amp 2 Knob selects 9~16, Range = 0~15. See list below.

Amp Models: 0= Explorer, 1= Tweed 410, 2= Blackface, 3= Line 6 Clean, 4= Class A-30, 5= Plexi Lead, 6= Brit 800, 7= Solo100, 8= Zen Master, 9= Small Tweed, 10= Blackface 212, 11= Modern Class A, 12= Class A-15, 13= Plexi 45, 14= Hiwatt 100, 15= Rectified

Cab Models: 0=Bypass, 1= 1X10 Gibson, 2= 4X10 Bassman, 3= 1X12 Deluxe, 4= 2X12 Line 6, 5= 2X12 Vox AC30, 6= 4X12 Marshall Greenback 25, 7= 4X12 Marshall V30, 8= 4X12 Soldano, 9= 2X12 Budda, 10= 1X12 Tweed, 11= 2X12 Twin, 12= 2X12 Matchless, 13= 1X12 VOX AC15, 14= 4x12 Marshall Greenback, 15= 4X12 Hiwatt, 16= 4X12 Mesa Boogie

Split/Blend Options (format = One Amp/Both Amps): 0=Blend/Blend; 1=Split/Blend; 2=Blend/Split; 3=Split/Split

MIDI Continuous Control Messaging (Part 2)

Amp Parameter	MIDI		MIDI CC Range			Notes
	TX	RX	CC#	Min	Max	
Reverb Enable		√	36	0	127	0~63=Off ; 64~127=On
Reverb Model		√	37	0	15	Range = 0~15, see list below
Reverb Decay		√	38	0	127	
Reverb Pre-Delay		√	40	0	127	Non-Spring types
Reverb Tone		√	39	0	127	
Split/Blend Mode		√	6	0	3	Range = 0~3. On prev. page
A.I.R. II Model		√	70	0	127	Range = 0~6. See list below.
FX Loop		√	107	0	127	0~63=Off ; 64~127=On
Tuner Enable		√	69	0	127	0~63=Off ; 64~127=On
Wah Enable	√	√	43	0	127	0~63=Off ; 64~127=On
Wah Position	√	√	4	0	127	
Vol Pedal Position	√	√	7	0	127	
Volume Pedal Minimum Position		√	46	0	127	
Volume PRE/POST		√	47	0	127	0~63 = Pre-Amp Model; 64~127 = Post-Amp Model
(FBV) Stomp Box 1	√		25	0	127	0~63=Off ; 64~127=On *
(FBV) Stomp Box 2	√		109	0	127	0~63=Off ; 64~127=On *
(FBV) Stomp Box 3	√		110	0	127	0~63=Off ; 64~127=On *
(FBV) Amp 1	√		111	0	127	0~63=Off ; 64~127=On
(FBV) Amp 2	√		112	0	127	0~63=Off ; 64~127=On
(FBV) Pitch/Tremolo	√		113	0	127	0~63=Off ; 64~127=On *
(FBV) Modulation	√		50	0	127	0~63=Off ; 64~127=On *
(FBV) Delay	√		28	0	127	0~63=Off ; 64~127=On *
(FBV) Reverb	√		36	0	127	0~63=Off ; 64~127=On *
(FBV) Tap	√		64	0	127	Momentary 127

Reverb Models: 0= Deluxe Spring, 1= Twin Spring, 2= King Spring, 3= Small Room 1, 4= Tiled Room 1, 5= Bright Room 1, 6= Dark Hall 1, 7= Medium Hall, 8= Really Large Hall, 9= Rich Chamber 1, 10= Rich Chamber 2, 11= Cavernous Chamber, 12= Slap Plate 1, 13= Plate, 14= Large Plate 1

A.I.R. II Models: 0=A.I.R. II Off, 1=Shure SM 57on axis, 2=Shure SM 57off axis, 3=MD 421 on axis, 4=MD4210 off axis, 5=U-67 on axis, 6= U-67 off axis

* = In addition to transmitting when a switch is stepped on, the state is stored with a Channel Memory and transmitted when the Channel loads

Customer Service

Before contacting the Line 6 Customer Service team, please take the time to look through this publication to see if it can answer your questions. Additional helpful information is on the Support page of the Line 6 web site (www.line6.com), including the searchable FAQTRAQ system which is often the fastest and easiest way to go answers.

Need to talk to an actual human on the Line 6 Customer Service team by phone? Have your serial number handy and take some notes for yourself before you call, so you remember everything you want to ask about. In the USA or Canada, you can contact Line 6 at (818) 575-3600, 8AM to 5PM Monday through Friday (Pacific Time). Outside the USA and Canada, please contact your distributor directly to arrange service. The list of Line 6 distributors is available on the Internet at www.line6.com.

To obtain factory service:

If a member of the Line 6 Customer Service Team determines that your Duoverb needs to be sent to Line 6 for service, you will be given a return authorization (RA) number. Products returned without an RA number will be returned to you at your sole expense. Pack the product in its original shipping carton and attach a description of the problem along with your name and a phone number where Line 6 can contact you if necessary. Ship the product insured and freight prepaid to Line 6 Customer Service, 6033 De Soto Avenue, Woodland Hills, CA 91367.

LINE 6 LIMITED WARRANTY INFORMATION

Sending in your registration card allows us to register key information so that we may handle problems faster and inform you of advance information, upgrades, and other news. Thanks in advance for filling out your registration card and sending it to us. And good luck in your music!

Line 6, Inc., warrants this product when purchased at an Authorized Line 6 Dealer in the United States of America or Canada, to be free of defects in materials and workmanship for a period of one year from the date of original purchase only upon completion and return of the Line 6 Warranty Registration form within 30 days from date of purchase. Please contact your distributor for information on warranty and service outside the USA and Canada. During the warranty period Line 6 shall, at its option, either repair or replace any product that proves to be defective upon inspection by Line 6. Line 6 reserves the right to update any unit returned for repair, and reserves the right to change or improve the design of the product at any time without notice. This warranty is extended to the original retail purchaser. This warranty can be transferred to anyone who may subsequently purchase this product within the applicable warranty period by providing Line 6 with all Warranty Registration information for the new owner and proof of transfer within 30 days of the purchase. Final determination of warranty coverage lies solely with Line 6. This is your sole warranty. Line 6 does not authorize any third party, including any dealer or sales representative, to assume any liability on behalf of Line 6 or to make any warranty for Line 6. Line 6 may, at its option, require proof of the original date of purchase in the form of a dated copy of the original authorized dealer's invoice or sales receipt. Service and repairs of Line 6 products are to be performed only at the factory (see below) unless otherwise authorized in advance by the Line 6 Service Department. Unauthorized service, repair or modification will void this warranty.

DISCLAIMER AND LIMITATION OF WARRANTY

THE FORGOING WARRANTY IS THE ONLY WARRANTY GIVEN BY LINE 6 AND IS IN LIEU OF ALL OTHER WARRANTIES. ALL IMPLIED WARRANTIES, INCLUDING WARRANTIES OF MERCHANTABILITY AND FITNESS FOR ANY PARTICULAR PURPOSE, ARE HEREBY EXCLUDED. UPON EXPIRATION OF THE APPLICABLE EXPRESSED WARRANTY PERIOD, LINE 6 SHALL HAVE NO FURTHER WARRANTY OBLIGATION OF ANY KIND, EXPRESSED OR IMPLIED. LINE 6 SHALL IN NO EVENT BE OBLIGATED FOR ANY INCIDENTAL OR CONSEQUENTIAL DAMAGES THAT MAY RESULT FROM ANY DEFECT OR WARRANTY CLAIM, EXPRESSED OR IMPLIED. Some states do not allow the exclusion or limitation of incidental or consequential damages or limitation on how long implied warranties last, so some of the above limitation or exclusion may not apply to you. This warranty gives you specific legal rights, and you may also have other rights which vary from state to state. This warranty only applies to products sold and used in the United States of America and Canada. Line 6 shall not be liable for damages or loss resulting from negligent or intentional acts of shipper or his contract affiliates. You should contact the shipper for proper claims procedures in the event of damage or loss resulting from shipment.