

KORG

AI² SYNTHESIS MODULE

GENERAL
MI
INSTRUMENT

PCI/F

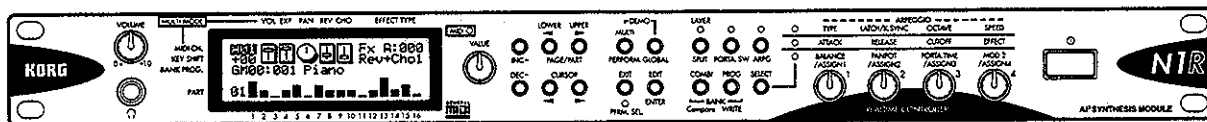

Owner's Manual

Precautions

Location

Using the unit under the following conditions can result in a malfunction.

- In direct sunlight
- In locations of extreme temperature or humidity
- In excessively dusty or dirty locations
- In locations of excessive vibration

Power supply

Please connect the AC/AC power supply to an AC outlet of the correct voltage. Do not connect it to an AC outlet of voltage other than that for which your unit is intended.

Handling

To avoid breakage, do not use excessive force on the keys, switches or controls.

Care

If the exterior becomes dirty, wipe it with a clean, dry cloth. Do not use liquid cleaners such as benzene or thinner, clearing compounds or flammable polishes.

Interference with other electrical devices

This product contains a microcomputer. Radios and televisions placed nearby may cause reception interference. Operate this unit at a suitable distance from radios and televisions.

Keep foreign matter out of your equipment

- Never set any container with liquid in it near this equipment. If liquid gets into the equipment, it could cause a breakdown, fire, or electrical shock.
- Be careful not to let metal objects get into the equipment. If something does slip into the equipment, unplug the AC/AC power supply from the wall outlet. Then contact your nearest Korg dealer or the store where the equipment was purchased.

Keep this manual

After reading this manual, please keep it for future reference.

CE mark for European Harmonized Standards

CE mark which is attached to our company's products of AC mains operated apparatus until December 31, 1996 means it conforms to EMC Directive (89/336/EEC) and CE mark Directive (93/68/EEC).

And, CE mark which is attached after January 1, 1997 means it conforms to EMC Directive (89/336/EEC), CE mark Directive (93/68/EEC) and Low Voltage Directive (73/23/EEC).

Also, CE mark which is attached to our company's products of Battery operated apparatus means it conforms to EMC Directive (89/336/EEC) and CE mark Directive (93/68/EEC).

THE FCC REGULATION WARNING

This equipment has been tested and found to comply with the limits for a Class B digital device, pursuant to Part 15 of the FCC Rules. These limits are designed to provide reasonable protection against harmful interference in a residential installation. This equipment generates, uses, and can radiate radio frequency energy and, if not installed and used in accordance with the instructions, may cause harmful interference to radio communications. However, there is no guarantee that interference will not occur in a particular installation. If this equipment does cause harmful interference to radio or television reception, which can be determined by turning the equipment off and on, the user is encouraged to try to correct the interference by one or more of the following measures:

- Reorient or relocate the receiving antenna.
- Increase the separation between the equipment and receiver.
- Connect the equipment into an outlet on a circuit different from that to which the receiver is connected.
- Consult the dealer or an experienced radio/TV technician for help.

Unauthorized changes or modification to this system can void the user's authority to operate this equipment.





Data handling

Improper usage can result in the loss of memory contents. Please be sure to save important data on an external data filer (storage device). Korg cannot accept any responsibility for any loss or damage which you may incur as a result of data loss.

LCD Display

Some pages of the manuals show LCD screens along with an explanation of functions and operations. All sound names, parameter names, and values are merely examples and may not always match the actual display you are working on.

Table of Contents

Introduction	1	3. Combination Edit mode	24
Features of the N1R	1	How a combination sound is organized	24
How to read this owners manual	1	Basic operation in Combination Edit mode	24
Front and rear panel	2	Selecting the program sound used by a timbre and adjusting its volume etc.	24
Front panel	2	Specifying where a timbre will play (layer, split, velocity switch)	25
Rear panel	3	Effect settings	25
Setup	5	Other combination sound parameters	26
 Connection to audio equipment etc.	6	Saving combination sound settings	26
 Connection to a MIDI keyboard	7	4. Program Edit mode	26
Connection to a computer	7	How program sounds are structured	26
Connection via MIDI	7	Basic operation in Program Edit mode	27
Connection to a computer via (TO HOST)	7	Oscillator settings (OSC section)	27
<BPS Select> setting	8	Filter settings (VDF section)	28
Wiring diagram of the serial interface cables	8	Amp settings (VDA section)	28
Turning the power on/off	9	Effect settings	29
Adjusting the volume	9	Modulation settings (Control section)	29
Listening to the demo songs	9	Applying realtime controller edits to the sound	29
		Saving program sound settings	29
Quick start	11	5. Effect Edit mode	30
 Performance Play mode	12	Effect structure	30
1. Listening to various sounds	12	About effect operation	30
2. Selecting a performance	12	Basic operation in Effect Edit mode	30
3. Using Single-channel Layer/Split and Portamento	13	Effect editing	31
4. Using the Realtime Controllers to modify the sound	14	Saving effect settings	31
5. Turning the arpeggiator on/off	15	6. Drumkit Edit mode	31
6. Performance-related settings	16	Drumkit structure	31
 Multi mode	17	Basic operation in Drumkit Edit mode	31
1. Playing in Multi mode	17	Arranging drumsamples	32
2. Controlling parts from your computer/sequencer	17	Saving a drumkit	32
Basic operation	19	7. Multi mode	32
Organization and sounds of the N1R	20	The structure of Multi mode	32
Organization of the N1R	20	Basic operation in Multi mode	33
The modes and sounds of the N1R	20	About voices, parts, and MIDI channels	33
1. Performance Play mode	21	Effect settings	33
How a performance is organized	21	Saving Multi mode settings	33
Basic operation in Performance Play mode	21	8. Part Edit mode	34
2. Performance Edit mode	22	Basic operation in Part Edit mode	34
Basic operation in Performance Edit mode	22	Saving Part Edit mode settings	34
Realtime controller assignments	22	9. Global mode	34
Setting the upper/lower parts and split point	22	Basic operation in Global mode	34
Arpeggiator settings	23	Saving Global mode settings	34
Effect settings	23	10. Demo mode	34
Setting other part parameters	23	Saving (writing) and renaming	35
Saving performance settings	23	Write protect	35
		Assigning a name (Rename)	35
		Write (save) procedure	35
		Restoring the factory settings	36

Reference guide	37	Appendices	81
1. Performance Play mode	38	Korg MIDI Driver	82
2. Edit Menu	38	Installing the Korg MIDI Driver for Windows 95 ...	82
3. Performance Edit mode	39	Installing the Korg MIDI Driver for Windows 3.1 ...	83
PERFORM-COMMON 1	39	Installing the Korg MIDI Driver for a Macintosh ...	84
PERFORM-COMMON 2	39	Control using MIDI	86
KNOB-ASSIGN	40	Compatibility with the N1/N5	90
ARPEGGIATOR 1	41	MIDI messages	91
ARPEGGIATOR 2	42	Program/Combination/Bank List, Performance List	91
4. Combination Edit mode	43	MIDI Channel Message	92
5. Program Edit mode	46	Part Parameter Change	93
OSC	46	Reset/Other Information	95
PITCH LFO	48	Voice Name List	96
PITCH EG	49	Troubleshooting	118
VDF	50	MIDI Implementation Chart	119
VDF LFO	51	Specifications	120
VDF EG	51	Options	120
VDA	53	Index	121
VDA LFO	53		
VDA EG	54		
Fx	55		
Control	55		
Rename	56		
6. Drumkit Edit mode	57		
7. Effect Edit mode	59		
Effect parameter table	62		
Effect types and parameters	64		
8. Multi mode	71		
9. Part Edit mode	72		
PART EDIT	72		
EG <PART-EG>	72		
Scale <PART-SCALE TUNE>	73		
Mod <PART: Mod>	73		
Fc/Win <PART-FILT /WIN>	75		
Others <PART-OTHERS>	75		
10. Global mode	76		
GLOBAL-MASTER	76		
HARDWARE	76		
GLOBAL-CONTROL	77		
MIDI FILTER	78		
RX SWITCH	78		
MIDI TO PORT	78		
PROG TO PORT	78		
PRESET/INIT	79		
MIDI DUMP	79		

Introduction

Thank you for purchasing the Korg N1R AI² synthesis module.

In order to enjoy long and trouble free use, please read this manual carefully and use the instrument correctly.

Features of the N1R

- The AI-squared synthesis system provides a generous **1,269 program sounds + 402 combination sounds** in internal memory, covering your needs for music production and performance in any musical genre. The effect section has **two independent full-digital processors**, with **48 types of effect** ranging from reverb to resonance filters.
- The 144 × 40 pixel LCD features a graphic iconic interface for intuitive operation and sound editing.
- The four **realtime controller knobs** can be used to modify parameters. You can also create complex performance setups using the **Single-channel Layer/Split function or Portamento function**.
- An **arpeggiator** (with twenty arpeggio types) is built-in, and can be combined with the **Single-channel Layer/Split function** for even more powerful possibilities.
- An ample **64 notes of polyphony** are provided. The PC interface allows direct connection to your computer. The N1R can be used as a 32 channel multi-timbral tone generator, and is able to playback a variety of SMF (Standard MIDI Files) with GM or GS/XG compatible sound maps.

How to read this owners manual

1. First, read from "Front and rear panel" to "Setup." This will explain basic topics such as connections with your audio system.
2. Next, read "Quick start." This explains how to select sounds and play the N1R.
3. The structure of the N1R's modes, the function of each mode, and basic editing operations are explained in "Basic operation."
4. Further details on the functions of the parameters in each mode are given in the "Reference" section.
5. The "Appendices" at the end of the manual include the following material:
 - "Control via MIDI" which explains how the N1R can be controlled by another MIDI device.
 - "Voice Name List" which provides lists of program sounds, combination sounds, drum kits, multisamples and drum samples.
 - "Troubleshooting"

* The "Apple" name and logo, Macintosh, MIDI Manager, and Patch-Bay are registered trademarks and trademarks of Apple Computer Corporation, USA.
 * IBM is a registered trademark of IBM Corporation, USA.
 * MS-DOS and Windows are registered trademarks and trademarks of Microsoft Corporation USA.
 * GS is a registered trademark of Roland Corporation.
 * XG is a registered trademark of Yamaha Corporation.
 * Other trademarks and corporate names are the registered trademarks and trademarks of their respective holders.

Front and rear panel

Front panel

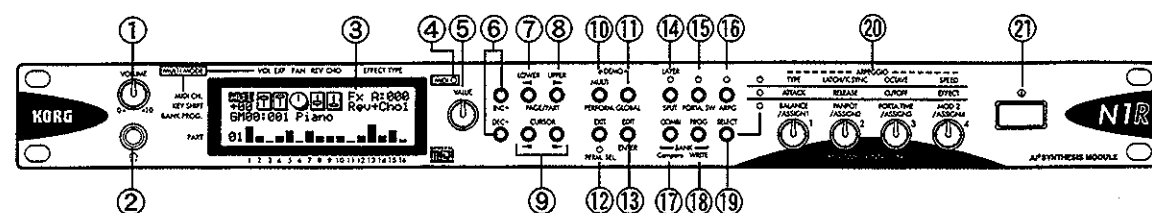

① [VOLUME] knob

This adjusts the volume from the OUTPUT jacks and headphone jack. Rotating the knob clockwise will increase the volume.

② Headphone jack

A set of stereo headphones with a standard 1/4" plug can be connected here.

③ LCD screen

This displays information such as the sound bank, sound name, the volume of each part, and other various parameters

④ MIDI indicator

This will light when MIDI messages are received from either the MIDI IN or the TO HOST connector.

⑤ [VALUE] knob

This is used to modify sounds and various settings. Rotating the knob clockwise will increase the value, and rotating it counterclockwise will decrease the value. This knob provides a convenient way to change a value rapidly.

⑥ [INC+] key, [DEC-] key

These are used to modify sounds and various settings. The value will increase by one each time the [INC+] key is pressed, and will decrease by one each time the [DEC-] key is pressed.

In Performance Play mode, you can simultaneously press the [INC+] key and [DEC-] key to access a sound list, and pressing these keys will move through the sounds in steps of ten. In Program Edit mode, you can simultaneously press the [INC+] key and [DEC-] key to cause the changes you made using the realtime controllers to be reflected in the program sound (refer to p.29).

⑦ PAGE/PART [◀] key

In Performance Play mode, this key selects the LOWER part if the Single-channel Layer/Split function is on. In Multi mode or Part Edit mode, this key returns to the previous part, and in Combination Edit mode it returns to the previous timbre. In other Edit modes and in Global mode, this key returns to the previous page.

⑧ PAGE/PART [▶] key

In Performance Play mode, this key selects the UPPER part if the Single-channel Layer/Split function is on. In Multi mode or Part Edit mode, this key advances to the next part, and in Combination Edit mode it advances to the next timbre. In other Edit modes and in Global mode, this key advances to the next page.

⑨ CURSOR [◀] key, [▶] key

These keys are used to select items in the LCD screen.

⑩ [MULTI/PERFORM.] key

Each time this key is pressed, Performance Play mode and Multi mode will alternate.

⑪ [GLOBAL] key

Press this to enter Global mode.

⑫ [EXIT/PFRM.SEL.] key

Press this key when you wish to exit the current page, or to cancel an operation such as Save, etc. In Performance Play mode, press this when you wish to change the performance (the LED will light).

⑬ [EDIT/ENTER] key

Press this key to enter the corresponding Edit mode. For details on entering Edit modes, refer to p.20 "Organization and sounds of the N1R." This key is also pressed to execute operations such as Save, etc.

⑭ [LAYER/SPLIT] key

This switches the Single-channel Layer/Split function in Performance Play/Edit mode. Each time you press this key, the function will cycle between Layer (LED lit)/Split (LED blinking)/Off (LED dark). In other modes, the indicator will neither light nor blink.

⑮ [PORTA. SW] key

This key switches the portamento function on/off. The LED will light when portamento is on.

⑯ [ARPG] key

This key turns the arpeggiator on/off. When the arpeggiator is on, the LED will blink in time to the specified arpeggio speed or to the MIDI Clock received from an external device.

⑰ [COMBI/Compare] key

In Performance Play mode and Multi mode, the combination sound bank will change each time this key is pressed.

In Edit mode, pressing this key will alternate between the sound prior to editing and the currently edited sound, allowing you to compare them.

⑱ [PROG/WRITE] key

In Performance Play mode and Multi mode, the program sound bank will change each time this key is pressed.

In Edit mode, pressing this key will write settings into memory (refer to p.35).

⑲ [SELECT] key

This selects one of three groups of functions for the realtime controllers.

⑳ [REALTIME CONTROLLER]

During a performance etc., these four knobs can be used to control sounds or the arpeggiator, as specified by the [SELECT] key.

㉑ [POWER] switch

This switch turns the power on/off.

Rear panel

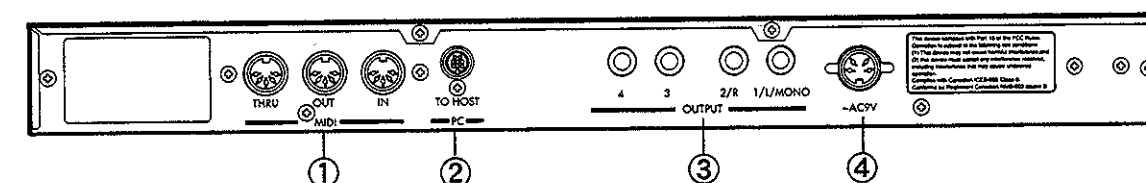

① MIDI IN, MIDI OUT, MIDI THRU

These ports allow external MIDI devices to be connected. MIDI IN receives MIDI messages. MIDI OUT transmits MIDI messages. Messages received at MIDI IN are re-transmitted without change to MIDI THRU.

② PC TO HOST

A computer can be connected to this jack. A serial cable (AG-001B/002B) allows direct connection to the com port of your personal computer to transmit and receive performance data, sound data, etc.

③ OUTPUT 1/L/MONO, 2/R, 3, 4

These connect these to your stereo amp, mixer, or multitrack recorder etc. When connecting a monaural amp, use the 1/L/MONO jack.

④ ~AC9V (AC/AC power supply connector)

Connect the included AC/AC power supply to this port.

Setup

Connection to audio equipment etc.

<Rackmounting the N1R>
 Front panel side N1R EIA standard case
 Screw Insulating washer Insulating bushing
 If you will be installing the N1R into an equipment rack, insert the insulating washers and insulating bushings into the holes.
 ⚠ If you will be placing the N1R directly on a table or other surface for use, please do not place another rack or computer etc. on top of the N1R.

If you wish to use headphones, connect them to the headphone jack on the front panel.

<Connecting powered monitors/stereo amp>
 In order to faithfully reproduce the sound of the N1R, we recommend that you use powered monitors whenever possible. If you wish to connect the N1R to a stereo audio amp or to a stereo cassette radio that has external input jacks, connect it to the jacks marked LINE IN, AUX IN or external input.
 ⚠ When the N1R is connected to a stereo audio amp, be careful not to raise the volume excessively, since playing it at high volumes may damage your speaker system.

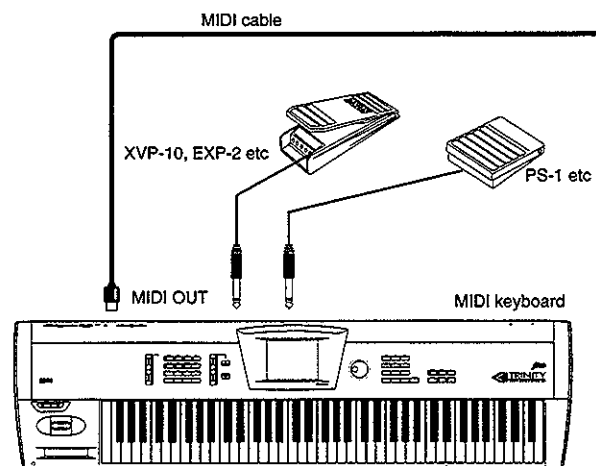
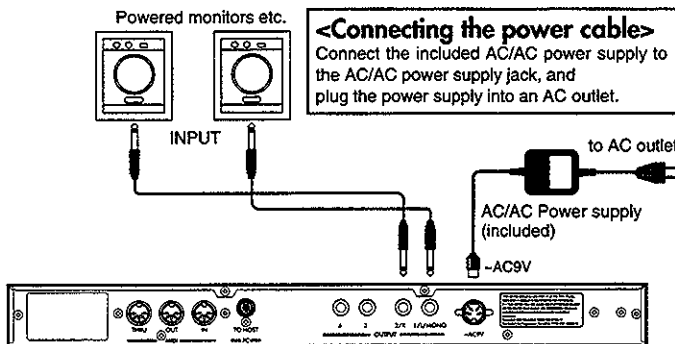

<Connections using the MIDI ports>
 If you wish to use a connected MIDI device to control the N1R (for example to playback data from an external sequencer on the N1R's tone generator), connect the MIDI IN connector of the N1R to the MIDI OUT connector of the MIDI device.
 To connect a computer, you will normally use the TO HOST connector.
 ⚠ By using the MIDI THRU connector, you can "daisy chain" several MIDI devices, but in order to prevent malfunctions we recommend that you limit such connections to 2-3 devices. If you need to connect more MIDI devices than this, use a MIDI patch bay.

<Mixer connections>
 Connect the OUTPUT jacks to your mixer. In order to take full advantage of the N1R's high-quality sound, we recommend that you play it in stereo whenever possible. If you wish to make monaural connections, use the 1/L/MONO jack.

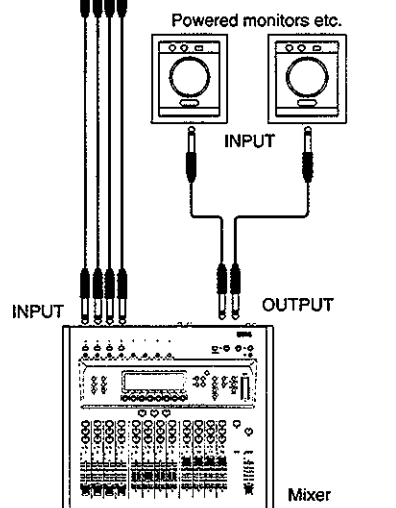

Connection to a MIDI keyboard

The N1R produces sound in response to MIDI messages transmitted from a MIDI device such as a MIDI keyboard.

As explained in <Connections using the MIDI Connectors> on the previous page, connect the N1R's MIDI IN connector to the MIDI OUT connector of your MIDI keyboard. Then make the following MIDI transmission settings on your MIDI keyboard.

* For details on operating your MIDI keyboard, refer to the owner's manual for your MIDI keyboard.

MIDI transmit channel

◇ Set the MIDI transmit channel of your MIDI keyboard to match the MIDI channel of the N1R's Upper part.

With the factory settings, the Upper part is set to MIDI channel 1. If you wish to use Performance Play mode functions such as Single-channel Layer/Split, the realtime controllers and arpeggiator, and effect dynamic modulation, set your keyboard to match the Upper part. If you wish to play other parts, set your keyboard to match the MIDI channel of the part that you wish to play. (For details on Multi mode, refer to p.17)

◇ If the transmit channel of your MIDI keyboard is fixed or if you do not wish to change it, you can change the MIDI receive channel of the N1R.

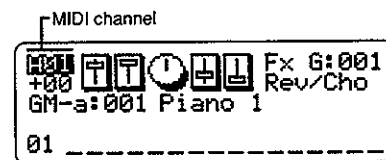

MIDI transmit filter

Some MIDI keyboards allow you to select the types of MIDI messages they will transmit. Make these settings as necessary.

The N1R is able to receive the following types of MIDI message.

Note-on/off (note messages):

These are the most basic type of messages, used to convey keyboard performance data.

Program change:

These messages are used to select sounds.

Control change:

These messages convey controller movements such as volume and pan settings.

Pitch bend:

These messages convey pitch changes from the pitch bender (joystick, wheel, lever).

Aftertouch:

These messages add expression depending on the amount of pressure that applied to the keyboard.

⚠ When the N1R is played, it will respond only to the MIDI messages which your MIDI keyboard transmits. For example if you are playing a MIDI keyboard (such as a digital piano) which is unable to transmit pitch bend messages, the pitch bend effect will not be available.

Connection to a computer

You can play the N1R from your computer by using either MIDI or serial interface cables to connect it to your computer.

Connection via MIDI

◇ To connect the N1R to a computer equipped with a MIDI interface, use MIDI cables to connect the MIDI OUT connector of your computer (MIDI interface) to the MIDI IN connector of the N1R.

* For details on connecting your computer and MIDI interface, and on making MIDI port settings, refer to the owner's manual for your MIDI interface.

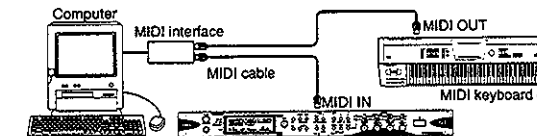

Connection to a computer via (TO HOST)

The N1R can also be played and controlled from your computer by using the included Korg MIDI Driver and a serial interface cable.

The N1R can be connected to the following computers using a special cable.

IBM PC (compatible):

Connection kit AG-001B(connection cable, Korg MIDI Driver software) [sold separately]

Apple Macintosh series:

Connection kit AG-002B(connection cable, Korg MIDI Driver software) [sold separately]

Connection to an IBM PC (compatible)

① Use the special cable AG-001B[sold separately] to connect the serial port (COM port) of your IBM PC (compatible) to the TO HOST connector of the N1R.

⚠ If the serial port of your computer uses a 25 pin connector, you will need to obtain a 9 pin-25 pin conversion adapter.

② Set the Global mode <BPS Select> parameter to 38.4 kBPS (refer to "<BPS Select> setting").

- ③ If you are using Windows, install the Korg MIDI Driver. For the installation procedure, refer to "Korg MIDI Driver" (p.82).

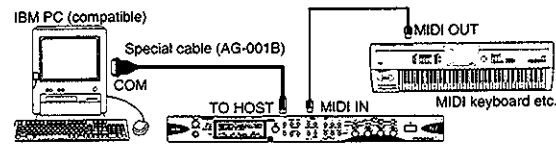

Connection to an Apple Macintosh

- ① Use the serial interface cable AG-002B [sold separately] to connect the modem port or printer port of your Apple Macintosh to the TO HOST connector of the N1R.
- ⚠ If the application (sequencer) which you are using has a clock setting, set it to 1 MHz.
- ② Set the Global mode <BPS Select> parameter to 31.25 kBPS (refer to "<BPS Select> setting").
- ③ If you wish to use the Korg MIDI Driver, refer to "Installing the Korg MIDI Driver for a Macintosh" (p.84).

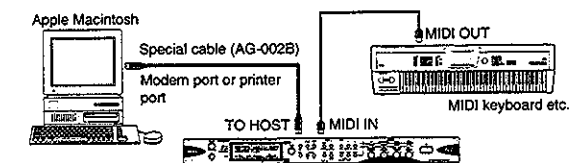

.....
<BPS Select> setting

This sets the rate at which data is transmitted between the computer and the N1R.

Note that the setting will depend on the type of computer that is connected.

- ① Press the [GLOBAL] key to enter Global mode.
- ② Use the PAGE/PART[◀][▶] keys to select <HARDWARE>.
- ③ Use the CURSOR[◀][▶] keys to select <BPS Select>.

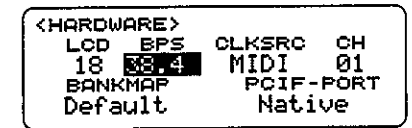

- ④ Use the [INC+][DEC-] keys or the [VALUE] knob to select the appropriate data transmission rate setting for the type of computer that is connected.

If an Apple Macintosh is connected, set this to 31.25 kBPS.

If an IBM PC (compatible) is connected, set this to 38.4 kBPS.

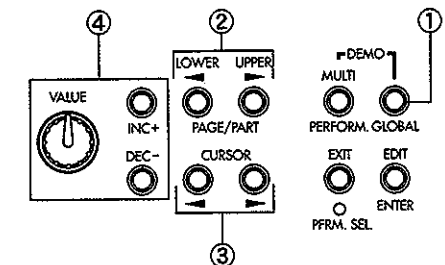

.....
Wiring diagram of the serial interface cables

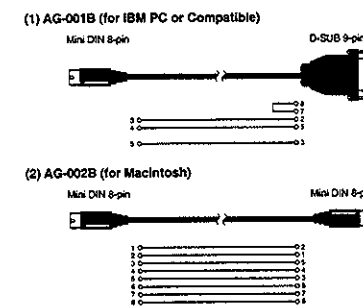

Turning the power on/off

- ① Press the [POWER] switch of the N1R to turn the power on.

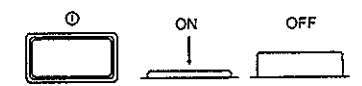

- ② Turn on the power of your powered monitored speakers or stereo amp.

When the N1R's power is turned on, a start display will appear for several seconds, and then the Performance Play mode display will appear.

When you press the [POWER] switch once again, the N1R's power will be turned off. Before turning off the N1R, turn off the power of your powered monitor speakers or stereo amp.

Listening to the demo songs

Let's listen to the built-in demo songs. This will also help to verify that your audio equipment is set up correctly. The N1R contains 2 demo songs. Listen to the demo songs to hear the rich variety of sounds and expressive potential offered by the N1R.

- ① Simultaneously press the [GLOBAL] key and [MULTI/PERFORM] key to enter demonstration mode.
- ② Use either the [VALUE] knob or the CURSOR [◀][▶] keys, the [INC+][DEC-] keys to select a demo song.
- ③ Press the [EDIT/ENTER] key, and after a short wait the demo song will begin playback.
- ④ To halt playback, press the [EXIT] key.
- ⑤ Press the [EXIT] key to exit demonstration mode.

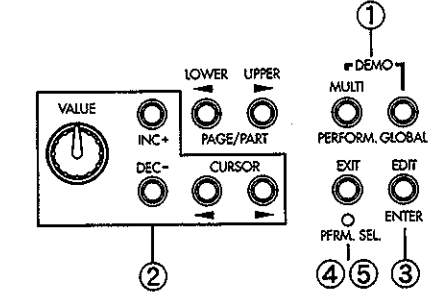

Adjusting the volume

Raise the [VOLUME] knob to adjust the volume to an appropriate level. The headphone volume is also adjusted by the [VOLUME] knob.

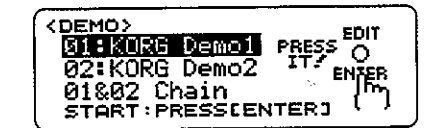
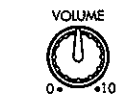

Setup

Quick start

Performance Play mode

Playing from a MIDI keyboard

When you wish to play the N1R from a MIDI keyboard and take advantage of performance functions such as its realtime controllers or arpeggiator, you should use Performance Play mode. The following section explains how to use Performance Play mode.

(When you wish to simultaneously playback multiple parts, such as when playing back a GM score on your computer/sequencer, you will normally use Multi mode.)

1. Listening to various sounds

① Press the [MULTI/PERFORM.] key to enter Performance Play mode.

You can switch between Performance Play mode and Multi mode by pressing the [MULTI/PERFORM.] key.

An example of the screen display in Performance Play mode

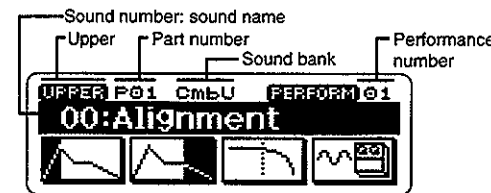

Select the sound number

② Use the CURSOR[◀][▶] keys to select Sound number : Sound name.

③ Use the [INC+][DEC-] keys or the [VALUE] knob to select a sound. At this time, the sound number : sound name will change in steps of ±1 (refer to "Voice Name List").

By simultaneously pressing the [INC+] and [DEC-] keys, you can view the sound list in units of ten sounds.

In this case, the [INC+][DEC-] keys will change the sound number : sound name in steps of ±10, and rotating the [VALUE] knob will change it in steps of ±1.

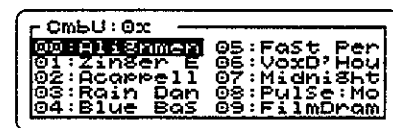

Simultaneously press the [INC+][DEC-] keys once again to return to the normal display.

Select the sound bank

④ Each time you press the BANK [COMBI] key, the combination sound bank will alternate in the following order: CmbU→CmbA→CmbB→CmbC.

⑤ Each time you press the BANK [PROG] key, the program sound bank will alternate in the following order: PrgU→PrgA→PrgB→PrgC.

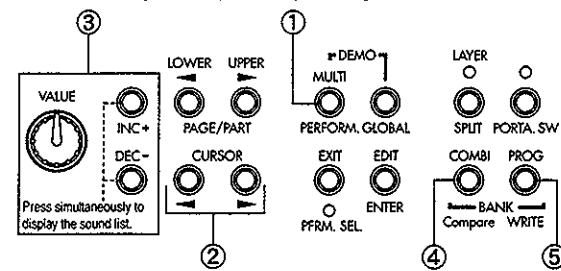

◇ You can also use the CURSOR[◀][▶] keys to select the sound bank, and use the [INC+][DEC-] keys or the [VALUE] knob to select other banks. However, these sound banks are intended mainly for playback of GM scores etc. (refer to p.20).

2. Selecting a performance

A performance refers to a set of settings that specify a sound for each part 1-16 including the Upper and Lower parts, and the settings of the [LAYER/SPLIT] key, the [PORTA.SW] key, the realtime controller knobs, and effect and arpeggiator settings (refer to p.21). Internal memory contains 32 sets of this data.

① Press the [MULTI/PERFORM.] key to select Performance Play mode.

You will alternate between Performance Play mode and Multi mode each time you press the [MULTI/PERFORM.] key.

② Press the [PRFM.SEL.] key to make the LED light. Now you can select a performance number.

③ Use either the [INC+][DEC-] keys or the [VALUE] knob to select a performance (1-32) (refer to "Voice Name List").

For example if you select performance #3 and play the C2 note of the Lower part (i.e., when the N1R receives this note number), an arpeggiated drum pattern and bass pattern will begin to play. You can play along with this in the Upper part using an organ sound.

④ Press the [PRFM.SEL.] key once again to make the LED go dark, and you will again be able to select sound numbers.

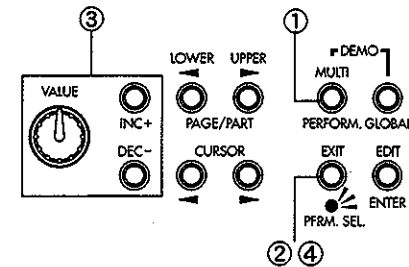

* These settings can be stored in a performance (refer to p.23).

3. Using Single-channel Layer/Split and Portamento

Using the [LAYER/SPLIT] key

In Performance Play mode, you can use single-channel layers in which playing a single note (receiving a single note number) will simultaneously sound the [UPPER] and [LOWER] program/combination sounds, or single-channel splits in which the [UPPER] and [LOWER] program/combination sounds will be sounded in different halves of the keyboard divided at the key (note number) that you specify.

These can be selected by pressing the [LAYER/SPLIT] key.

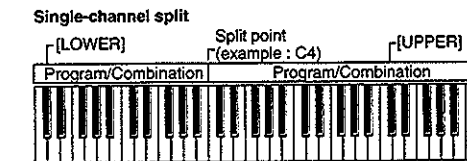
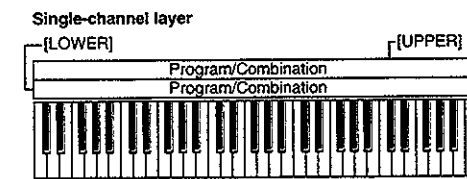

* As explained later in this manual, it is also possible to create layers and splits as Combination sounds, and this allows you to use a greater number of sounds etc. (refer to p.25).

① Press the [MULTI/PERFORM.] key to enter Performance Play mode.

You will alternate between Performance Play mode and Multi mode each time you press the [MULTI/PERFORM.] key.

② Press the [LAYER/SPLIT] key to select either single-channel layer or split.

Each time you press this key, you will cycle from layer (LED lit) → split (LED blinking) → off (LED dark).

An example of the screen display for single-channel layer/split



Selecting the sound number/bank

③ Use the LOWER[◀] and UPPER[▶] keys to select the sound that you wish to change.

④ Use either the [INC+][DEC-] keys or the [VALUE] knob to change the sound.

⑤ You can change the bank by pressing the BANK [PROG] or [COMB] key. The bank will change each time the button is pressed.

• You can press the [SELECT] key to make the third LED light, and use the realtime controller [BAL-

ANCE/ASSIGN1] (1) knob to adjust the volume balance between the Upper part and the Lower part. On the factory set performances, you can use the realtime controller [BALANCE/ASSIGN1] (1) knob to adjust the volume balance between Upper and Lower.

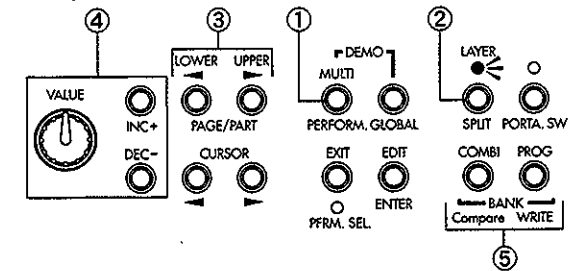

▲ Single-channel Layer/Split is valid in Performance Play/Edit modes when the Global mode <Single-channel Layer/Split> setting is turned ON.

Changing the split point

The location at which the sounds of the Upper part and the Lower part are divided on the keyboard is called the "split point," and this can be changed in Performance Edit mode <Split point> (refer to p.22, p.40).

Applying a damper pedal effect to the Upper part or Lower part

In Performance Edit mode <Damper Assign> (refer to p.39), you can apply a damper effect to the Upper part and Lower part independently.

Using the [PORTAMENTO] key

You can apply a portamento effect to make the pitch change smoothly from one note to the next.

① To turn on the portamento effect, press the [PORTA.SW] key to make the LED light. The effect will alternate on/off each time the switch is pressed.

• If you press the [SELECT] key to make the third LED light, you can use the realtime controller [PORTA.TIME/ASSIGN3] (3) knob to modify the portamento time (the time over which the pitch changes to the next note) as you play. With the factory performance settings, the realtime controller [PORTA.TIME/ASSIGN3] (3) knob is assigned to Portamento Time.

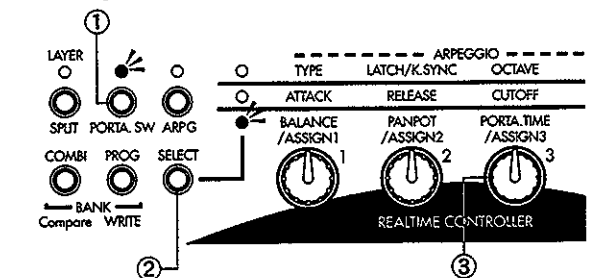

* The [LAYER/SPLIT] and [PORTAMENTO] functions can be stored as part of a performance (refer to p.23).

▲ When the [LAYER/SPLIT] key is on, the realtime controllers and [PORTA.SW] etc. will apply to either the Upper or the Lower part, whichever sound name is selected. ((c) BALANCE is an exception.)

4. Using the Realtime Controllers to modify the sound

The N1R provides four knobs which let you control the pitch, tone, and volume in realtime.

- Press the [SELECT] key (the LED will light) to select the functions which the knobs will control.

The functions of the four knobs will change each time you press the [SELECT] key. The row of functions indicated by the LED will be active.

(a) TYPE	LATCH/K.SYNC	OCTAVE	SPEED
(b) ATTACK	RELEASE	CUTOFF	EFFECT
(c) BALANCE/ ASSIGN 1	PANPOT/ ASSIGN 2	PORTA.TIME ASSIGN 3	MOD.2 ASSIGN 4

Here, we will explain functions (b) and (c). For details on functions (a), refer to the next section "5. Turning the arpeggiator on/off."

- Rotate each knob to adjust the corresponding function.

Rotating the knob to left or right will decrease or increase the setting.

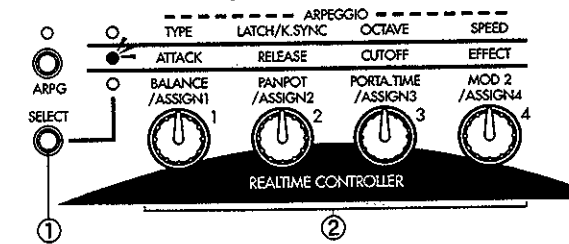

(b) ATTACK

This affects the brightness (VDF) and volume (VDA) of the beginning of the sound.

Rotating the [ATTACK] knob will change the time over which the VDF/VDA changes from key-on (when a note is pressed) until the attack level is reached. Normally, rotating the knob toward the right will slow the attack, and rotating it toward the left will sharpen the attack (refer to p.72).

(b) RELEASE

This affects the brightness (VDF) and volume (VDA) of the sound when it decays after the note is released.

Rotating the [RELEASE] knob will change the time over which the sound decays after the note is released (the release time). Normally, rotating the knob toward the right will lengthen the release time, and rotating it toward the left will shorten the release time (refer to p.72).

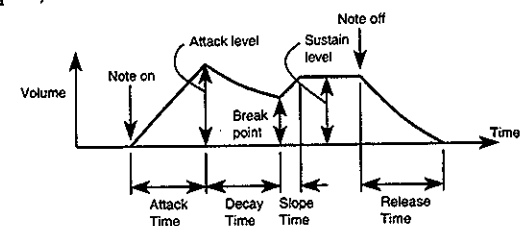

(b) CUTOFF

This adjusts the VDF cutoff frequency (VDF Filter Cutoff) to control the brightness of the sound.

Rotating the [CUTOFF] knob will increase or decrease the VCF cutoff frequency value (refer to <Cutoff Frequency> p.75), changing the brightness of the sound. Normally, rotating the knob toward the right will brighten the tone, and rotating it toward the left will darken the tone.

(b) EFFECT

This controls Effect Dynamic Modulation. The result will depend on the effect that is selected for each sound.

(c) BALANCE

This adjusts the volume balance for the sounds of the Upper part and Lower part.

If this is set to Lower when the Single-channel Layer/Split function is not on, you will hear no sound.

(c) PANPOT

Adjusts the stereo location for the sound of the Upper or Lower part (refer to <Panpot> p.71).

(c) PORTA. TIME

Adjusts the portamento time (refer to <Portamento Time> p.76).

(c) MOD 2

The effect specified by the Part Edit mode item Mod parameter MOD.2. See <Part Pitch Bend Range> p.73 - <Part VDA LFO Depth> p.74.

(c) ASSIGN 1-4

For details on the parameters which can be assigned to each knob and their functions, refer to p.40. With the factory settings, the above parameters will be assigned.

* When you are playing in Performance Play mode or Multi mode, and wish to control a different part, use the PAGE/PART[◀|▶] keys to change parts.

* The settings of these controllers is memorized for each performance (refer to p.23).

When the [LAYER/SPLIT] key is on, the effect (with the exception of (c) BALANCE) will apply to the Upper or Lower part selected by the cursor.

Operating the realtime controllers will edit the Part parameters. The program/combination sound itself will not be edited.

If after moving the four knobs in Performance Play mode, you want your changes to be reflected in the program sound, enter Program Edit mode and immediately press both the [INC+] and [DEC-] keys simultaneously.

5. Turning the arpeggiator on/off

The arpeggiator of the N1R contains 20 preset arpeggio patterns.

You can specify the octave, velocity, and groove etc. for the arpeggio notes, to produce a wide range of variations. You can also make the arpeggio play in only the Upper or Lower part when the [LAYER/SPLIT] key is on.

- Press the [ARPG] key to turn on the arpeggiator (the LED will blink). Now play a connected external keyboard (i.e., transmit note-on messages), and an arpeggio will begin playing automatically.

Press the [ARPG] key once again to make the LED go dark and turn off the arpeggiator.

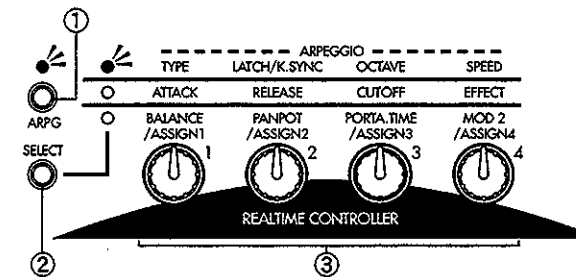

- To modify various settings of the arpeggiator, press the [SELECT] key to make the (a) row LED light.

- Rotate the knobs to modify the following functions.

(a) TYPE

Selects the type of arpeggio. Twenty different arpeggio patterns are available.

(a) LATCH/K.SYNC

Selects how the arpeggiator will operate. As you rotate the knob from left to right, the selection will change from OFF→LATCH→K.SYNC→L+K.S. With a setting of LATCH or L+K.S, the arpeggio will continue playing even after you release the note. With a setting of K.SYNC or L+K.S, the KEY-SYNC function will operate, causing the arpeggio to be re-started each time the external keyboard is played.

(a) OCTAVE

Specifies the octave range over which the arpeggio will be played.

The arpeggio can be played over a range of 1-4 octaves.

(a) SPEED

Adjusts the tempo of the arpeggio as desired.

* The arpeggio can also be synchronized to an external MIDI clock (refer to p.76).

♦ Making the arpeggio play notes in the order in which keys (note-on messages) were pressed

The Performance Edit mode parameter <Arpeggio Sort> (refer to p.42) lets you make the notes of the arpeggio sound in the order in which they were played, or in ascending order of pitch.

♦ Varying the arpeggio pattern

The Performance Edit mode <Arpeggio Step Base>, <Arpeggio Velocity>, <Arpeggio Gate> and <Arpeggio Swing> parameters allow you to modify the interval of the steps, the velocity and duration of the arpeggio notes, and the feeling of "groove." This allows you to produce a wide variety of arpeggios (refer to p.41).

♦ Using the arpeggiator with the Upper part or Lower part when the [LAYER/SPLIT] key is on

By editing the Performance Edit mode <Arpeggio Zone> parameter, you can specify whether the arpeggio will be played only in the Upper or Lower part, or in both parts (refer to p.42).

6. Performance-related settings

The process of modifying settings in the various Edit modes is referred to as **editing**. For editing procedure, refer to the following section "Basic operation."

Tuning to another instrument

Transposing

If you wish to play the N1R together with another instrument, or to play along with music from a CD or tape, you may need to adjust the pitch of the N1R to match the other instruments or music. This is referred to as **tuning**, and is done by adjusting the Global mode <Master Tune> parameter (refer to p.76). The pitch can be adjusted over a range of -100 cents (semitone downward) to +100 cents (semitone upward).

The pitch can also be adjusted in semitone steps, and this is referred to as **transposing**. If you wish to transpose the entire N1R, adjust the Global mode <Master Key Shift> parameter (refer to p.76). If you wish to transpose an individual part, adjust the Multi mode <Key Shift> parameter (refer to p.71). In either case, you can transpose over a range of -24 (two octaves downward) to +24 (two octaves upward). The Upper and Lower parts can be transposed in one-octave steps over a range of two octaves upward or downward, by adjusting the Performance Edit mode <Performance Octave> parameter.

- ① Press the [GLOBAL] key to enter Global mode.
- ② Use the PAGE/PART[◀][▶] keys to select the <GLOBAL-MASTER> page.
- ③ Use the CURSOR[◀][▶] keys to move the cursor (highlighted area), and select <Master Tune> if you wish to adjust the tuning, or <Master Key Shift> if you wish to transpose the entire N1R.
- ④ Use the [VALUE] knob or the [INC+][DEC-] keys to adjust the pitch.

Transposing individual parts

- ① Press the [MULTI/PERFORM.] key to enter Multi mode.
Performance Play mode and Multi mode will alternate each time you press the [MULTI/PERFORM.] key.
- ② Use the PAGE/PART[◀][▶] keys to select the part that you wish to transpose.
- ③ Use the CURSOR[◀][▶] keys to move the cursor to select <Key Shift>.
- ④ Use the [VALUE] knob or the [INC+][DEC-] keys to modify the pitch.

Bypassing the effects

In Performance Play mode (or in Multi mode), you can temporarily apply or bypass the effects.

- ① In Performance Play mode, press the [EDIT] key to access the <Edit Menu>, and then use the CURSOR[◀][▶] keys to select Perform. Then press the [EDIT] key to enter Performance Edit mode.
- ② Use the PAGE/PART[◀][▶] keys to select the <PERFORM-COMMON1> page.
- ③ Use the CURSOR[◀][▶] keys to move the cursor to <Effect Thru Switch>.
- ④ Use the [VALUE] knob or the [INC+] key to select Thru, or press the [DEC-] key to apply the effect.

Specifying the pitch bend range

You can specify the pitch bend range of each part. This allows you to simulate techniques such as "bending" strings on an electric guitar. For example when the Single-channel Layer/Split function is on, and you are playing a piano sound in the Upper part and a bass sound in the Lower part, you can make settings so that pitch bending affects only the lower part.

If you wish to change the range of pitch bend, modify the settings of the Part Edit mode <Part Pitch Bend Range> parameter (refer to p.73) or the Program Edit mode PITCH LFO <Pitch Bend Range> parameter (refer to p.48). For a combination sound, you can set <Receive Pitch Bend> (refer to p.44) to disable reception of pitch bend messages.

Changing the velocity curve

You can select one of eight types of curve to specify how key velocity will affect the dynamics (refer to p.77).

Changing the aftertouch curve

You can select one of eight types of curve to specify how aftertouch will be applied (refer to p.78).

Creating an original scale

You can create your own original scale and play using that scale. Part Edit mode <Scale Tuning> (refer to p.73).



Multi mode

Playing the N1R from a computer/sequencer

When you wish to simultaneously playback multiple parts, such as when playing a GM score etc. from your computer/sequencer, you will normally use **Multi mode**. This section provides a simple explanation of Multi mode operation.

* For details on control via MIDI, refer to "Control using MIDI" and "MIDI messages."

The N1R can be used as a multi-timbral tone generator with a total of 32 channels (16 channels each for A and B). It provides 32 parts, and a different program sound or combination sound can be assigned to each part. On the N1R, a **part** is analogous to a musician in a band. The N1R has 32 parts, meaning that you can simulate an ensemble of up to 32 musicians. For example, part 1 might be assigned to play a piano, part 2 a bass, part 3 a trumpet and so on.

The volume and pan etc. can be adjusted independently for each part. In addition, you can adjust the sound in Part Edit mode by modifying the EG or modulation settings (refer to p.34, p.72).

1. Playing in Multi mode

- ① Press the [MULTI/PERFORM.] key to enter Multi mode.
Performance Play mode and Multi mode will alternate each time the [MULTI/PERFORM.] key is pressed.
For parts 1-16, the settings of the currently selected performance will be in effect. For the parameters which are affected, refer to p.21.
- * When a SysEx message such as GM System On, XG System On, or GS Reset is received, the N1R will automatically switch to Multi mode.

An example of the Multi mode display screen

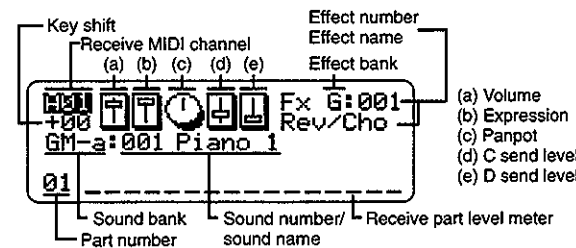

In Multi mode, the playing status of each of the 32 parts is shown in the LCD. When the N1R is producing sound in response to musical data received from an external device, the indicator for the corresponding part will move like a level meter.

If you press the [EXIT/PFRM.SEL.] key, the display will indicate DISP, and you can view the volume and panpot settings etc. for each part.

- ② Use the PAGE/PART[◀][▶] keys to select a part.
- ③ Use the CURSOR[◀][▶] keys to select the sound number or sound bank, and use the [INC+][DEC-] keys or [VALUE] dial to select the sound. The bank can also be switched by pressing the BANK [COMBI] or [PROG] keys.
- ④ Use the CURSOR[◀][▶] keys to select the Receive MIDI channel, Key Shift (transposition), Volume, Panpot, or Effect, and use the [VALUE] knob or the [INC+][DEC-] keys to modify the values.

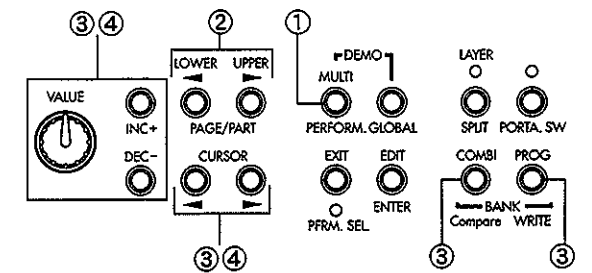

2. Controlling parts from your computer/sequencer

MIDI transmit/receive channel

Set the MIDI transmit channel of your computer/sequencer to match the <Receive MIDI channel> of the N1R part that you wish to play. For the first 16 parts in the N1R, the MIDI channel and part number correspond with each other (for example, part 2 is MIDI channel 2, part 10 is MIDI channel 10). In Multi mode, it is not possible to use the Single-channel Layer/Split function. MIDI messages such as control changes will affect only the parts that are receiving the channel on which these messages are transmitted. However, effect dynamic modulation will be received on the channel specified by the Global mode setting <Exclusive Channel>. Also, the arpeggiator will operate when it receives note-on messages on the MIDI channel for the part specified by the <Arpeggio Zone> setting (p.42).

When you operate the control knobs of the realtime controller, messages will be transmitted on the MIDI channel of the currently selected part. Output from the arpeggiator will be transmitted on the MIDI channel of the part that is being played. System exclusive messages are transmitted and received on the <Exclusive Channel>.

Selecting the sound number of a part

To select the sound number of a part from your computer/sequencer, transmit a program change message on the MIDI channel for the corresponding part.

To change the bank, you will have to transmit control change #0 and 32 bank select messages. The N1R will not change the program/combination sound immediately when a bank select message is received. The program/combination sound of the specified bank will be selected when the program change message is received following the bank select message.

Quick start

Transmit bank select [Bn, 00, mm] (control change #00) and [Bn, 20, bb] (control change #32) (mm: upper byte of the bank number, bb: lower byte of the bank number) and program change [Cn, pp] (pp: program/combination number).

Bank	MIDI bank select and value	
	#0:#32	#0:#32
CmbU	88:00	(58h:00h)
CmbA	89:00	(59h:00h)
CmbB	90:00	(5Ah:00h)
CmbC	91:00	(5Bh:00h)
PrgU	80:00	(50h:00h)
PrgA	81:00	(51h:00h)
PrgB	82:00	(52h:00h)
PrgC	83:00	(53h:00h)
GM-b	56:00	(38h:00h)
ySFX	64:00	(40h:00h)
kDrm	62:00	(3Eh:00h)
GM-a / PrgU	00:00	(00h:00h)*
rDrm or yDrm / KDrm	120:00	(78h:00h)*

* This will depend on whether the Global mode <Bank Map Type> is set to Default or to 05R/W (refer to p.77).

These are program numbers used to select drum programs within the drum program bank. Here we will discuss KDrm.

Drum program	Program number	
GM Kit	1-16, 57-64, 75-128	(00h-0Fh, 38h-3Fh, 4Ah-7Fh)
Power Kit	17-24	(10h-17h)
Dance Kit	25, 27-32	(18h, 1Ah-1Fh)
Analog Kit	26	(19h)
Jazz Kit	33-40	(20h-27h)
Brush Kit	41-48	(28h-2Fh)
Orch Kit	49-56	(30h-37h)
Perc Kit	65-72	(40h-47h)
User Kit 1	73	(48h)
User Kit 2	74	(49h)

* The functionality for transmitting and specifying bank select and program numbers will differ depending on your sequencer or sequencer software. Refer to the owner's manual for your sequencer or sequencer software for details on operation.

Selecting a performance

To select a different performance (01-32) from your computer/sequencer, transmit bank select and program change messages in the same way as when selecting a program/combination sound. However, the LSB will be ignored. These messages must be transmitted on the MIDI channel specified by the <Exclusive Channel> parameter.

Transmit bank select [Bn, 00, 5F] (control change #00) and program change [Cn, pp] (pp:00-1F, performance 01-32).

Performance	MIDI bank select	Program change
	CTRL #0:#32	
01	95:xx (5Fh:xx)	0 (00h)
:	:	:
:	:	:
32	95:xx (5Fh:xx)	31 (1Fh)
(LSB ignore)		

Various playing settings

By transmitting control change, RPN, and NRPN messages from your computer/sequencer, you can adjust playing settings such as the volume and pan of each part. Also, Part Edit mode allows you to adjust EG or modulation to modify the sound, and these settings can also be changed via exclusive messages. For details refer to p.86 "Control using MIDI," p.91 "MIDI messages," and p.119 "MIDI implementation chart."

Control from your computer/sequencer in Performance Play mode

As with Multi mode, Performance Play mode lets you use 32 part playback. As with Multi mode, you can use MIDI to control the sound. In addition, any two parts (1-16) can be selected in Performance Play mode as the <Lower Part Number> and the <Upper Part Number>, and played from your keyboard.

This allows you to playback 30 parts from your computer/sequencer as accompaniment, and play two parts with Single-channel Layer/Split from your keyboard.

Basic operation

Organization and sounds of the N1R

Organization of the N1R

On the N1R, a group of related functions is collectively referred to as a "mode." The functions of the N1R are organized into ten modes as shown in the following diagram.

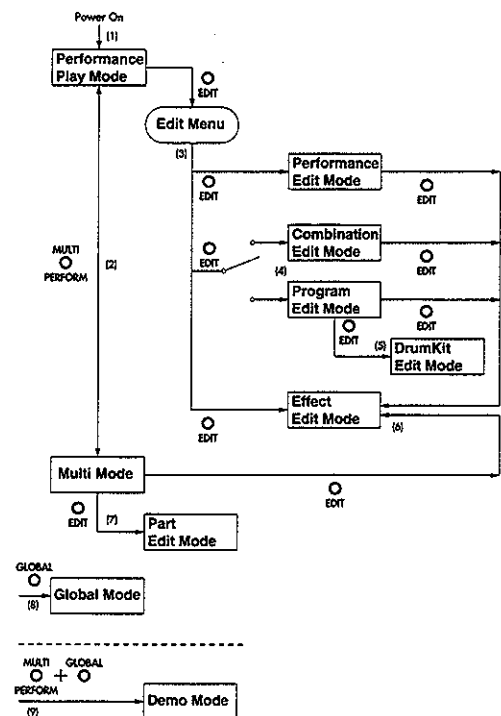

You can move between modes as follows.

- When the power is turned on, you will be in **Performance Play mode**.
- In **Performance Play mode**, pressing the [MULTI/PERFORM.] key will select **Multi mode**. Each time you press the [MULTI/PERFORM.] key, you will alternate between Performance Play mode and Multi mode.
- In **Performance Play mode**, pressing the [EDIT/ENTER] key will display the **Edit menu**. Use the CURSOR[◀][▶] keys to select the desired Edit mode (**Performance Edit mode**, **Combination Edit mode**, **Program Edit mode**, **Effect Edit mode**), and press the [EDIT/ENTER] key to access the selected mode.
- To access **Combination Edit mode**, select a combination sound in Performance Play mode, select the **Combi icon** in the **Edit menu** of paragraph (3), and press the [EDIT/ENTER] key. Similarly, you can access **Program Edit mode** by selecting a program sound in Performance Play mode, selecting the **Program icon** in the **Edit menu** of paragraph (3), and pressing the [EDIT/ENTER] key.

- To select **Drumkit Edit mode**, set the Oscillator Mode to **DRUMS** in Program Edit mode, and press the [EDIT/ENTER] key.
- In addition to using the procedure described in paragraph (3), **Effect Edit mode** can also be accessed by pressing the [EDIT/ENTER] key at the <Effect Bank/Number> of Performance Edit mode, Combination Edit mode, Program Edit mode or Multi mode.
- In **Multi mode**, press the [EDIT/ENTER] key to select **Part Edit mode**.
- Press the [GLOBAL] key to select **Global mode**.
- Simultaneously press the [MULTI/PERFORM.] key and the [GLOBAL] key to select **Demo mode**.

The modes and sounds of the N1R

Performance Play mode and **Multi mode** are the modes which you will use when connecting a MIDI keyboard or computer/sequencer to play the N1R. In these two modes, you can play **Program sounds** or **Combination sounds**. These sounds are stored in several banks. These sounds can be edited in **Combination Edit mode** or **Program Edit mode** respectively, to create the sounds you want. Program sounds can be further classified into conventional sounds such as piano, organ, or brass, and drum programs. The **drumkits**, which are the basis of drum programs, can be edited in **Drumkit Edit mode**.

Performance Edit mode lets you edit the function assignments of realtime controllers and performance functions such as the arpeggiator. **Effect Edit mode** allows you to edit the effects which are used by program/combination sounds and in a performance. **Part Edit mode** allows you to temporarily modify the sounds that will be used to playback song data of various formats in Multi mode, without rewriting the actual program/combination sounds themselves. Some of these settings can be saved as part of a performance. **Global mode** allows you to save N1R data on an external device, or to adjust the tuning etc.

Bank names and their contents

The N1R contains the program, combination and drumkit banks shown below. The program names etc. in each bank are listed in "Voice name list."

Bank	Remark
CmbU	Combination sounds: user bank (rewritable)
CmbA	Combination sounds: bank A
CmbB	Combination sounds: bank B
CmbC	Combination sounds: bank C
PrgU	Program sounds; user bank (rewritable)
PrgA	Program sounds: bank A
PrgB	Program sounds: bank B
PrgC	Program sounds: bank C
GM-a	GS sounds and basic GM sounds for XG
r:01...r:40	GM variation sounds for GS
r:CM	CM-64 (Roland) sounds
y:01...y:101	GM variation sounds for XG
ySFX	SFX sounds for XG
GM-b	05R/W sounds, basic GM sounds for X5 series
yDr1	SFX drum bank for XG
yDr2	Normal drum bank for XG
rDrM	Drum bank for GS
kDrM	05R/W, X5 series drum bank
****	silent sounds

Of these banks, only PrgU and CmbU are rewritable. Other banks are in ROM (Read Only Memory), and any modified ROM sounds can only be saved in either the PrgU or CmbU banks.

1. Performance Play mode

This mode is used mainly for playing program sounds or combination sounds while taking advantage of performance functions such as the realtime controllers, single-channel layer/split, portamento, and the arpeggiator.

As with Multi mode, backing parts can be pressed simultaneously from your computer.

How a performance is organized

A performance consists of a set of 16 parts (the first half of the 32 parts of Multi mode), and contains **Part Parameter** data which specifies the sound bank/number, volume and panpot etc. for each part, and **Part Common** data which applies to all parts (assignments for the four realtime controller knobs, single-channel layer/split, the arpeggiator, and effects).

The N1R's internal memory contains 32 of these performances.

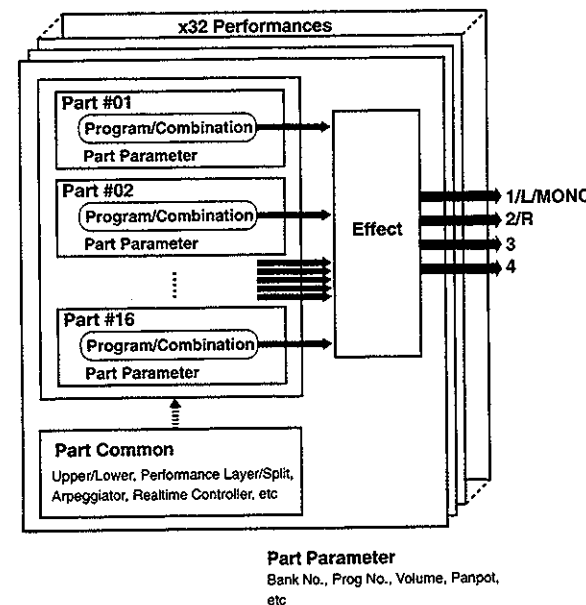

Edited data	Editing location
Part parameters for 16 parts	Part edit (refer to Multi mode, Part edit mode, and "Part parameter change" in the appendix)
Effect parameters (1 effect)	Effect edit in Multi, Effect Edit in Performance (Internally, the same effect data is used for Multi and for Performance)
Master volume, Master key shift	Performance edit (Performance Edit mode)
Single Ch. Layer/Split condition	Panel switches
Part number for upper/lower parts	Performance play (Performance Play mode)
Upper and lower level balance	Control knobs
Split point for when single Ch. split is used	Performance edit (Performance Edit mode)
Control knob/pedal assignments	Performance edit (Performance Edit mode)
Select key status	Panel switches
All arpeggiator parameters	Panel switches + Performance edit (Performance Edit mode)
Portamento on/off status	Panel switches

- Each performance that you save consists of the above data. 32 performances can be saved in internal memory.
- Part parameters for parts 17-32 and Modify Drum parameters are not remembered (refer to <Part Mode> p.75).

Basic operation in Performance Play mode

This mode will be selected when the power is turned on.

- From any mode other than Performance Play mode, you can press the [MULTI/PERFORM.] key to enter Performance Play mode. Each time you press this key, you will alternate between Performance Play mode and Multi mode.
- Use the CURSOR[◀][▶] keys to select the desired parameter.
- Use the [VALUE] knob or the [INC+][DEC-] keys to modify the value.
- For other operations, refer to "Quick start."

In the case of single-channel layer/



- If you want the results of moving the four knobs in Performance Play mode to be applied to the program sound that you edit, enter Program Edit mode and immediately press both the [INC+] and [DEC-] keys (p.29).

2. Performance Edit mode

Here, you can assign functions to the four realtime controller knobs for use in Performance Play mode, and make settings for single-channel layer/split and the arpeggiator.

Basic operation in Performance Edit mode

- Press the [MULTI/PERFORM.] key to select Performance Play mode. Each time you press the [MULTI/PERFORM.] key, you will alternate between Performance Play mode and Multi mode.
- Press the [PFRM.SEL.] key to make the LED light, and use the [VALUE] knob or the [INC+][DEC-] keys to select the performance that you wish to edit.
- Press the [EDIT/ENTER] key to access the <Edit Menu> display.
- Use the CURSOR[◀][▶] keys to select **Perform**, and press the [EDIT/ENTER] key.
- Use the PAGE/PART[◀][▶] keys to select the desired page, and use the CURSOR[◀][▶] keys to select the desired parameter.
- Use the [VALUE] knob or the [INC+][DEC-] keys to modify the value of the parameter.

For details on the function of each parameter, refer to the Reference section "3. Performance Edit mode."

Realtime controller assignments

- As described in "Basic operation in Performance Edit mode," select the performance that you wish to edit, and enter Performance Edit mode.
- Use the PAGE/PART[◀][▶] keys to select <KNOB-ASSIGN>, and press the CURSOR[◀] key to select <Control knob #1 Type>.

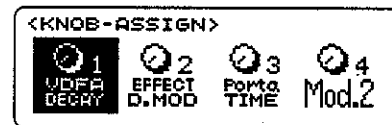

- In this example, we will select VDEFA DECAY. Use the [VALUE] knob or the [INC+][DEC-] keys to select this.
- Press the CURSOR[▶] key to select <Control knob #2 Type>. Then use the [VALUE] knob or the [INC+][DEC-] keys to select EFFECT D.MOD.
- Use the realtime controller [SELECT] key to make the third LED light. While playing your keyboard, rotate [control knob #1] to modify the EG Decay Time, and rotate [control knob #2] to modify the effect modulation depth.

- If you wish to save the changes you made, execute the Write operation (p.23, p.35) to store the performance. This will save the changes produced by the location of the knobs as well as the position of the [SELECT] key. With the factory settings, the frequently used [BALANCE], [PANPOT], [PORTA.TIME] and [MOD2] are assigned.

Setting the upper/lower parts and split point

Here's how to specify the Upper and Lower parts which will be used when single-channel layer/split is used. You can also specify the split point (note number) at which the Upper part and Lower part will be divided on the keyboard when single-channel split is used.

- As described in "Basic operation in Performance Edit mode," select the performance that you wish to edit.
- Press the [LAYER/SPLIT] key to select either single-channel layer or split.
Each time you press the [LAYER/SPLIT] key, you will cycle between Layer (LED lit) → Split (LED blinking) → off (LED dark).
- Press the CURSOR[◀] key to select the UPPER "part number," and use the [VALUE] knob or the [INC+][DEC-] keys to select the part number that you wish to use as the Upper part. Next, press the CURSOR[▶] key to select "sound bank" and "sound number:sound name" respectively, and use the [VALUE] knob or the [INC+][DEC-] keys to select the sound bank and sound name that you wish to use for the Upper part.
- In the same way, press the CURSOR[▶] key to select the LOWER "part number," and select the sound bank and sound name.
- Press the PAGE/PART[▶] key to move to Upper, and enter Performance Edit mode as described in "Basic operation in Performance Edit mode."
- Use the PAGE/PART[◀][▶] keys to select <PERFORM COMMON 2>.

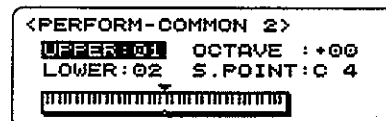

- You will see that the part numbers you specified in steps ③ and ④ are selected. If you wish to change the part numbers for the Upper/Lower parts, you can also do so here.
- Next, use the CURSOR[◀][▶] keys to select <Split Point>, and specify the key (note number) at which the Upper and Lower parts will be divided when single-channel split is used. The note number specified here and all higher notes will play the Upper sound. You can also set the split point by holding down the [EDIT/ENTER] key and playing a note on

your keyboard (i.e., by transmitting a note number).



- If you wish to save the Upper/Lower part numbers and the split point setting, execute the Write operation (p.23, p.35) to store the performance. When this is done, the on/off status of the [LAYER/SPLIT] key will also be remembered.

Arpeggiator settings

- As described in "Basic operation in Performance Edit mode," select the performance that you wish to edit, and enter Performance Edit mode.
- Use the PAGE/PART[◀][▶] keys to select <ARPEGGIATOR 1> or <ARPEGGIATOR 2>, and use the CURSOR[◀][▶] keys to select the parameter that you wish to edit. (refer to p.41)

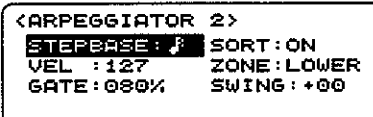

- Press the [ARPG] key to turn it on (lit), and use the [VALUE] knob or the [INC+][DEC-] keys to modify the value of the selected parameter.
- If you wish to save your settings, execute the Write operation (p.23, p.35) to store the performance. When this is done, the on/off status of the [ARPG] key will also be remembered.

Effect settings

The sound of each part in a performance is routed through two independent digital multi-effect units before being sent from the stereo (and 3 and 4) outputs.

- As described in "Basic operation in Performance Edit mode," select the performance that you wish to edit, and enter Performance Edit mode.
- Use the PAGE/PART[◀][▶] keys to select <PERFORM-COMMON 1>.
- Use the CURSOR[◀][▶] keys to select <Effect Bank Select> or <Effect Number Select>, and use the [VALUE] knob or the [INC+][DEC-] keys to select the bank and effect number of the desired effect program.

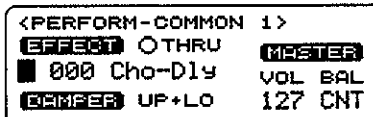

- If you wish to modify the parameter values of the selected effect, press the [EDIT/ENTER] key to enter Effect Edit mode.

For details on editing procedure in Effect Edit mode, refer to "Effect editing."

- If, after you finish editing, you wish to save the edited effect within the performance, press the [EXIT] key twice (without saving in Effect Edit mode) to return to Performance Edit mode. Then execute the Write operation.

- It is also possible to specify the panning (A, B) at which each part will be input to the effects, and the send amount (effect send C and D). These settings are made in Multi mode (refer to p.71).

Setting other part parameters

If part parameters intended for a performance have been edited outside of Performance Edit mode (refer to the table "Editing location" p.21), you can enter Performance Edit mode or Part Edit mode and execute the Write operation to save the changes in the performance. For the procedure of saving in Part Edit mode, refer to p.34.

Saving performance settings

The parameters of a performance (part common, and part parameters for parts 1-16) can be saved by ① pressing the [WRITE] key while in Performance Edit mode or Part Edit mode, ② using the [VALUE] knob or the [INC+][DEC-] keys to select the save destination number, and ③ pressing the [WRITE] key.
To save the effects of a performance, ① enter Effect Edit mode and make the desired edits. ② Press the [EXIT] key to return to the <Edit Menu> without saving. ③ Go to Performance Edit mode and press the [WRITE] key. ④ Use the [VALUE] knob or the [INC+][DEC-] keys to select the save destination number. ⑤ Press the [WRITE] key to save the data. You can also save these settings in Part Edit mode.

- Be aware that when you execute the Write operation, the data will overwrite the previous contents of the saving location, and the original data will be lost. Also, if you press the [EXIT] key or press a key to leave this mode without executing the Write operation, your edits will be lost.

3. Combination Edit mode

Here, you can edit combination sounds that can be played in Performance Play mode or in Multi mode.

How a combination sound is organized

Combination sounds consist of up to eight timbres ("slots" to accommodate one program sound each; see diagram below), and can be used as though they were a single program sound. Since up to eight program sounds can be played at once, you can create extremely powerful sounds, which is a real advantage when playing a live concert. For each program sound used by a timbre, you can independently specify the volume, pan (stereo location), effect send level, keyboard range and velocity range, and how it will be controlled by MIDI messages. However for effect settings, only the two effects specified by the combination will be valid.

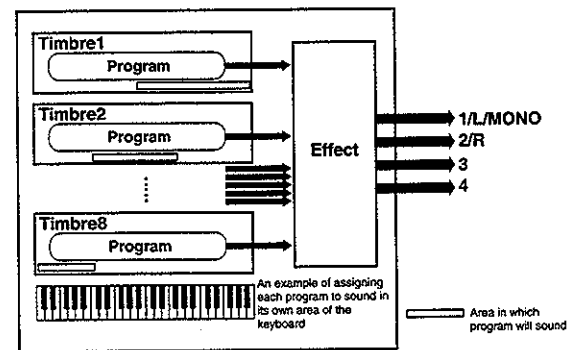

In **Combination Edit mode** you can specify how these program sounds will be arranged, and make various other settings.

402 combination sounds are available, and they are stored in the following five banks.

CmbU, CmbA, CmbB, CmbC, yDr1

The CmbU bank can accommodate one hundred combination sounds that you create by editing combination in the N1R.

When you finish editing, execute the Write operation (refer to p.35) if you wish to save your edits.

"Editing a combination sound" refers to the process of selecting a program for each of the eight timbres of the combination sound, modifying the sounds, and specifying the range of the keyboard in which each program will sound, etc.

Basic operation in Combination Edit mode

- Press the [MULTI/PERFORM.] key to enter Performance Play mode. Each time you press the [MULTI/PERFORM.] key, you will alternate between Performance Play mode and Multi mode.
 - (For the Upper part) select the combination sound that you wish to edit.
 - Press the [EDIT/ENTER] key to access the <Edit Menu>.
 - Use the CURSOR[◀][▶] keys to select **Combi**, and press the [EDIT/ENTER] key.
- * In Performance Play mode if a program sound is selected (for the Upper part), the LCD will indicate **Program** instead of **Combi**.
- Use the PAGE/PART[◀][▶] keys to select the timbre that you wish to edit, and use the CURSOR[◀][▶] keys to select a parameter.
 - Use the [VALUE] knob or the [INC+][DEC-] keys to modify the parameter value.

Selecting the program sound used by a timbre and adjusting its volume etc.

- As described in "Basic operation in Combination Edit mode," select the combination sound that you wish to edit, and enter Combination Edit mode.
- Use the PAGE/PART[◀][▶] keys to select the timbre that you wish to edit. Use the CURSOR[◀][▶] keys to select <Timbre Bank Select> and <Timbre Program Number Select>, and use the [VALUE] knob or the [INC+][DEC-] keys to select the desired program sound.



- Next we will adjust the volume of the timbre which you selected in step ②. Use the PAGE/PART[◀][▶] keys to select the timbre whose volume you wish to adjust, press the CURSOR[▶] key to select <Timbre Volume>, and use the [VALUE] knob or the [INC+][DEC-] keys to adjust the volume to the desired level. Panpot and transpose settings can also be adjusted in the same way.
- If the timbre for which you are making settings does not sound, press the CURSOR[▶] key to select <Receive Note On>, and use the [VALUE] knob or the [INC+][DEC-] keys to turn it ON. Timbres that you do not wish to sound may be turned OFF.

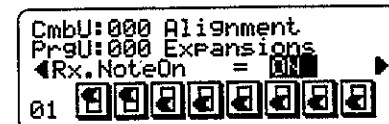

If the timbre still does not sound, check the <Note Window Bottom>-<Velocity Window Top> settings. Also, if you have selected a program sound for which the Program Edit mode <Oscillator Panpot> parameter is turned OFF, no sound will be output if the C/D send levels are at zero.

Unlike the previous 05R/W and X5DR models, a combination can have only one MIDI channel.

Specifying where a timbre will play (layer, split, velocity switch)

In a combination sound, the program assigned to each timbre can be triggered in three ways: **layer**, **split**, or **velocity switch**.

* While the single-channel layer/split function specified by the [LAYER/SPLIT] key is designed to allow you to instantly switch the Upper and Lower sounds for convenient playing, the layer, split, and velocity switch settings described here allow you to assign up to eight program sounds in their own areas of the keyboard and to make additional detailed settings.

Layered

Two or more timbre programs will sound when you play the keyboard.

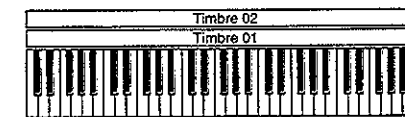

Split

Different timbre programs will sound depending on the keyboard area that you play.



Velocity Switch

Different timbre programs will sound depending on the velocity (the force of your playing).

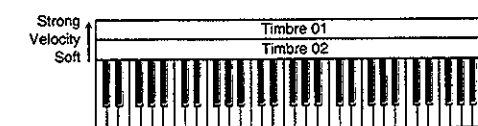

- As described in "Basic operation in Combination Edit mode," select the combination sound that you wish to edit, and enter Combination Edit mode.



- In step ④ of "Selecting the program sound used by a timbre and adjusting its volume etc.," turn <Receive Note On> ON for two or more timbres.

- Press the CURSOR[▶] several times to select <Note Window Bottom>. Use the [VALUE] knob or the [INC+][DEC-] keys to specify the lowest note that this timbre will sound. You can also make this setting by holding down the [EDIT/ENTER] key and pressing a note on your keyboard (i.e., transmitting a note number).



- Once again press the CURSOR[▶] key to select <Note Window Top>. Here you will specify the highest note that this timbre will sound (refer to step ③).

To create a **layer-type combination sound**, set the <Note Window Bottom> to C-1 and the <Note Window Top> to G9 for both of the (for example) two timbres for which you set <Receive Note On> to ON in step ③ ④ of the previous procedure. With these settings, the areas in which the two timbres sound will overlap.

To create a **split-type combination sound**, set a <Note Window Bottom> setting of C4 and a <Note Window Top> setting of G9 for one of the (for example) two timbres for which you set <Receive Note On> to ON in step ③ ④ of the previous procedure. For the other timbre, set <Note Window Bottom> to C-1 and <Note Window Top> to B3 etc. With these settings, the areas in which the two timbres sound will be separate.

- In addition, if you wish to create a **velocity-switch type combination sound**, use the CURSOR[◀][▶] keys to select <Velocity Window Bottom> and <Velocity Window Top>, and specify the minimum and maximum velocity values for which the timbre will sound.

For example, suppose that you set one timbre to a <Velocity Window Bottom> of 80 and a <Velocity Window Top> of 127, and the other timbre to a <Velocity Window Bottom> of 01 and a <Velocity Window Top> of 79. With these settings, the timbre sounds will depend on how strongly the note was played. Softly played notes will be sounded by one timbre, and strongly played notes will be sounded by the other timbre. Adjust the values (80, 79) as appropriate for your playing style.

Effect settings

Combination sounds are routed through two independent digital multi-effect units, and are sent from the stereo (or 3 and 4) outputs. You can specify the panning (A, B) at which the sound will be input to the effects, and the send amount (effect send C and D).

- As described in "Basic operation in Combination Edit mode," select the combination sound that you wish to edit, and enter Combination Edit mode.

- ② Use the PAGE/PART[◀][▶] keys to select the timbre that you wish to edit, and use the CURSOR[◀][▶] keys to select <Timbre Panpot>, <Timbre C Send Level>, or <Timbre D Send Level>, and use the [VALUE] knob or the [INC+][DEC-] keys to specify the position **A** and **B** for input to the effects, and the send amounts **C** and **D** to the effects. (Refer to <Effect Placement> p.59.)
- ③ Use the CURSOR[◀][▶] keys to select <Effect Bank Select> and <Effect Number Select>, and use the [VALUE] knob or the [INC+][DEC-] keys to select the bank and effect number of the desired effect program.
- ④ If you wish to modify the parameter values of the selected effect, press the [EDIT/ENTER] key to enter **Effect Edit mode**.
For details on the editing procedure in Effect Edit mode, refer to "Effect editing."

Other combination sound parameters

In addition to the parameters described above, Combination Edit mode allows you to set MIDI message reception filters <Receive Control Change>, <Receive Pitch Bend>, <Receive Aftertouch>, <Receive Damper>, <Receive Portamento>, and the parameters <Timbre Transpose>, <Timbre Fine Tune>, and <Combination Rename>. For details on each of these parameters, refer to p.43 "Combination Edit mode."

Saving combination sound settings

- ① In Combination Edit mode, press the [WRITE] key.
 - ② Use the [VALUE] knob or the [INC+][DEC-] keys to select the save destination number. ③ Press the [WRITE] key to save the data.
- Similarly, to save effect settings, ① press the [WRITE] key in Effect Edit mode. ② Use the [VALUE] knob or the [INC+][DEC-] keys to select the save destination number. At this time be sure to select effect bank **U** for combination sounds. ③ Press the [WRITE] key to execute.
- ⚠ Be aware that when you execute the Write operation, the data in the writing destination will be overwritten and lost. If you press the [EXIT] key or exit this mode by pressing another mode key, your edits will be lost.
 - ⚠ Be aware that if you edit a program sound which is assigned to a combination, the sound of the combination will also change.

4. Program Edit mode

Here, you can edit the program sounds for playing in Performance Play mode or Multi mode.

How program sounds are structured

Program sounds are the most basic type of sounds. There are 1269 program sounds. These 1269 program sounds can be broadly divided into two types: those which use normal multisamples (such as piano or brass) for the oscillator, and those which use a **drumkit (DRUMS)** for the oscillator. A **drumkit** is a collection of **drumsamples** such as bass drum, snare, or hi-hat which are assigned to each note of the keyboard. Programs which use normal multisamples can be either **SINGLE** (using only one multisample) or **DOUBLE** (using two multisamples).

Program sounds are organized into the following banks.

GM-a, r01-r40, r:CM, y01-y101, ySFX, GM-b, PrgU, PrgA, PrgB, PrgC, yDr2, rDrm, kDrm

The PrgU bank can accommodate one hundred program sounds that you create by editing the programs in the N1R.

Programs of the N1R are organized in the following way:

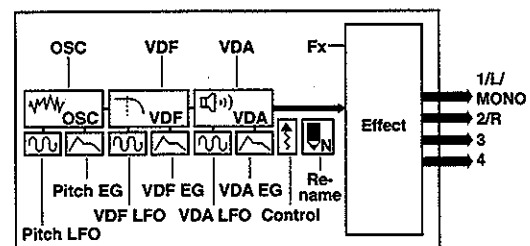

OSC (Oscillator)

In this section you can select the waveform which will determine the basic character of the sound. Select a multisample as the basic waveform, and set various parameters for the oscillator.

Pitch LFO

This applies cyclic modulation to the pitch, creating a vibrato effect.

Pitch EG

This specifies how the pitch will change over time.

VDF (Variable Digital Filter)

This section lets you use a low pass filter to modify the waveform by attenuating or boosting the high-frequency portion of the sound. This will change the tonal character (brightness) of the sound.

VDF LFO

This applies cyclic modulation to the tone, creating a wah effect.

VDF EG

This specifies how the tone will change over time.

VDA (Variable Digital Amplifier)

This applies time-varying change to the volume which is output from the VDF section. "Volume change" in this case refers to the way in which the volume of an individual note changes from the time that a key is struck until that key is released and the note decays to silence.

VDA LFO

This applies cyclic modulation to the volume, creating a tremolo effect.

VDA EG

This specifies how the volume will change over time.

Control

This section contains parameters related to the various modulation effects and settings such as portamento.

Fx (Effect)

In this section you can select the effects used by a program, and set the effect send amounts etc. Two completely independent stereo multi-effect units are provided.

Rename

The Rename section lets you assign a new name to the program or to modify the existing name.

"Program sound editing" refers to the process of setting parameter values to modify program sounds in order to edit existing program sounds or to create completely new sounds.

Basic operation in Program Edit mode

- ① Press the [MULTI/PERFORM.] key to enter Performance Play mode. Each time you press the [MULTI/PERFORM.] key, you will alternate between Performance Play mode and Multi mode.
- ② For the Upper part, select the program sound that you wish to edit.
- ③ Press the [EDIT/ENTER] key to access the <Edit Menu>.
- ④ Use the CURSOR[◀][▶] keys or the [INC+][DEC-] keys to select **Program**, and press the [EDIT/ENTER] key.
- * If in Performance Play mode you select a combination sound for the Upper part, the LCD will indicate **Combi** instead of **Program**.
- ⑤ Use the PAGE/PART[◀][▶] keys or the CURSOR[◀][▶] keys to select the desired section, and press the [EDIT/ENTER] key to enter the selected section.
- ⑥ Use the CURSOR[◀][▶] keys to select the parameter that you wish to edit, and use the [VALUE] knob

or the [INC+][DEC-] keys to modify the parameter value.

If the OSC Mode is **DOUBLE**, you can move between the two oscillators by pressing the [EDIT/ENTER] key in a parameter page where this applies. If the OSC Mode is **SINGLE**, it will not be possible to edit the OSC2 parameters. If the OSC Mode is **DRUMS**, pressing the [EDIT/ENTER] key will allow you to edit the drumkit.

You can also use the PAGE/PART[◀][▶] keys to move through the pages.

Oscillator settings (OSC section)

One way to edit program sounds is to modify an existing program sound that is similar to the desired result. Alternatively, if you wish to create a program sound from scratch, you will normally select a multisample first in this section, and then proceed to edit the parameters of other sections.

- ① As described in "Basic operation of Program Edit mode," select the program sound that you wish to edit, and enter Program Edit mode.
- ② In <Program Edit>, press PAGE/PART[◀] or CURSOR[◀] to select the OSC section, and press the [EDIT/ENTER] key.
- ③ Press the CURSOR[◀] key to select <Oscillator Mode>, and use the [VALUE] knob or the [INC+][DEC-] keys to set the **oscillator mode**.

If you set the <Oscillator Mode> to **SINGLE**, you can use one oscillator to create the program sound. With a setting of **DOUBLE**, you can use two oscillators to create the program sound. With a setting of **DRUMS**, you can use a drumkit oscillator to create the program sound.

If the <Oscillator Mode> is set to **DOUBLE**, you can move between the oscillator 1 and 2 editing pages by pressing the [EDIT/ENTER] key.

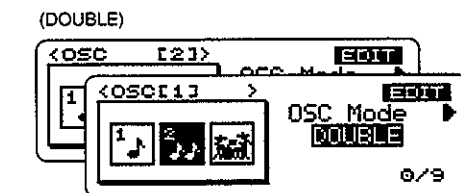

Initially, it will probably be best for you to set <Oscillator Mode> to **SINGLE** when you edit, so that the results will be more obvious. If you want to create an especially thick or complex sound, you can select **DOUBLE**, and add settings for oscillator 2.

- ④ Press CURSOR[▶] to move to the <Multisample Select> page. Here you can use the [VALUE] knob or the [INC+][DEC-] keys to select a **multisample**. Play your keyboard to hear the selected multisample.

If you set the VDF <Cutoff Frequency> parameter to 127 (maximum) and use an organ-like envelope with no change, you will be able to hear the original sound of the actual multisample.

Basic operation

- ⑤ Use the CURSOR[◀][▶] keys to move to the <Octave Select> page. Use the [VALUE] knob or the [INC+][DEC-] keys to adjust the pitch of the oscillator in one-octave steps.
- ⑥ Use the CURSOR[◀][▶] keys to move the cursor to <Oscillator Level>. Use the [VALUE] knob or the [INC+][DEC-] keys to set the volume of the oscillator.
- ⑦ Use the CURSOR[◀][▶] keys to select other parameters of the OSC section, and edit them in the same way.
- ⑧ Use the PAGE/PART[◀][▶] keys to select the PITCH LFO page. Use the CURSOR[◀][▶] keys to select <Pitch LFO Waveform>. Here, you can cyclically modulate the pitch of the oscillator to create vibrato. Use the [VALUE] knob or the [INC+][DEC-] keys to select the waveform of the pitch LFO.

If the pitch change produced by the Pitch LFO is not audible, try setting <Pitch LFO Intensity> to approximately +80.

You can also control the vibrato depth or speed by receiving aftertouch or control change #1 messages (refer to p.48).

Filter settings (VDF section)

The filter adjusts the tone (brightness, etc.) by cutting or boosting a specified portion of the oscillators frequency content. The sound can change dramatically depending on the these filter settings. The filters of the N1R are low pass filters (LPF). Use them to modify the tone. An LPF is a filter which allows the portion below the cutoff frequency to pass, and cuts the higher portion. As the higher overtones are attenuated, a bright sound will become darker (more muted).

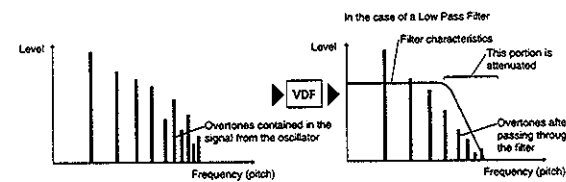

- ① As described in "Basic operation in Program Edit mode," select the program sound that you wish to edit, and enter Program Edit mode.
- ② In <Program Edit>, use the PAGE/PART[◀][▶] keys or the CURSOR[◀][▶] keys to select the VDF section, and press the [EDIT/ENTER] key.
- ③ Use the CURSOR[◀][▶] keys to select <Cutoff Frequency>, and use the [VALUE] knob or the [INC+][DEC-] keys to modify the value. Notice that the tonal quality becomes brighter or darker.

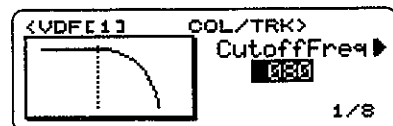

- ④ Press the PAGE[▶] key twice to move to the VDF EG page.



- ⑤ Use the CURSOR[◀][▶] keys to select parameters such as <VDF EG Attack Time> (Attack Time), <VDF EG Attack Level> (Attack Lvl), and <VDF EG Decay Time> (Decay Time), and use the [VALUE] knob or the [INC+][DEC-] keys to modify their values. Notice how the tonal quality changes over time.

The value of the area indicated in the EG graphic in the LCD screen will change. If you cannot hear the result of the changes you make, try raising the <VDF EG Intensity> value to approximately +80.

Amp settings (VDA section)

The amp section creates change in the volume over time. We are referring here to the volume change which takes place within each note, such as "sounds which rise to their full volume immediately when a key is pressed," or "sounds which decay slowly." For example when you play a note on a piano, the sound will begin at the maximum volume, and will then decay slowly. On the other hand, a note played on an organ will maintain the same volume until the key is released, and a note played on a violin can be varied in volume throughout the duration of the note. It is the role of the VDA section to create this type of volume change.

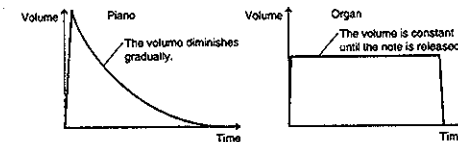

- ① As described in "Basic operation in Program Edit mode," select the program sound that you wish to edit, and enter Program Edit mode.
- ② In <Program Edit>, use the PAGE/PART[◀][▶] keys or the CURSOR[◀][▶] keys to select VDA EG, and press the [EDIT/ENTER] key.
- ③ Use the CURSOR[◀][▶] keys to select parameters such as <VDA EG Attack Time> (Attack Time), <VDA EG Attack Level> (Attack Lvl), and <VDA EG Decay Time> (Decay Time), and use the [VALUE] knob or the [INC+][DEC-] keys to modify their values. Notice how the volume changes over time. The value of the area indicated in the EG graphic in the LCD screen will change.
- ④ Press the PAGE/PART[◀] key twice to enter the VDA section.



- ⑤ Here, you can make settings for VDA keyboard tracking. VDA keyboard tracking is a function which varies the volume according to the keyboard location (note number). This is used to even out the volume balance of a sound that is played over a wide range of pitches.

The <VDA Keyboard Tracking Mode> and <VDA Keyboard Tracking Key> parameters specify the keyboard area to which this function will apply, and <VDA Keyboard Tracking Intensity> specifies the amount of VDA volume change that will occur in the specified area of the keyboard. Use the CURSOR[◀][▶] keys to select parameters, and use the [VALUE] knob or the [INC+][DEC-] keys to modify the value as you listen to the result.

Similarly, the VDF section also has a VDF keyboard tracking function, and this is used to adjust the tonal character according to the keyboard location (note number).

When you are using double mode to layer two sounds, you can set the keyboard tracking parameter <VDA Keyboard Tracking Key> to the same setting for both oscillators, and invert the polarity ("+" and "-") of the <VDA Keyboard Tracking Intensity> of the two oscillators. This will create a positional crossfade effect (i.e., where the balance of the two sounds will change according to the keyboard location).

Effect settings

The sound of a program is sent through two completely independent digital multi-effect units before being sent to the stereo (or 3 and 4) outputs. You can specify the stereo position of the sound that will be input to the effects (A and B), and the send amount (effect send C and D).

- ① As described in "Basic operation in Program Edit mode," select the program sound that you wish to edit, and enter Program Edit mode.
- ② In <Program Edit>, use the PAGE/PART[◀][▶] keys or the CURSOR[◀][▶] keys to select Fx (Effect), and press the [EDIT/ENTER] key.
- ③ Use the CURSOR[◀][▶] keys to select <Oscillator Panpot> and <C Send Level/D Send Level>, and use the [VALUE] knob or the [INC+][DEC-] keys to specify the panning of the input to the effects A and B, and the send amount to the effects C and D. (Refer to <Effect Placement> p.59)
- ④ Use the CURSOR[◀][▶] keys to select <Effect Bank Select> and <Effect Number Select>, and use the [VALUE] knob or the [INC+][DEC-] keys to select the bank and effect number of the desired effect program.
- ⑤ If you wish to modify parameter values for the selected effect, press the [EDIT/ENTER] key to enter Effect Edit mode.

For the procedure of editing in Effect Edit mode, refer to "Effect editing."

Modulation settings (Control section)

Here, you can adjust the depth with which incoming MIDI messages will control modulation, specify how notes will be sounded (monophonically/polyphonically), and make settings for portamento etc.

- ① As described in "Basic operation in Program Edit mode," select the program sound that you wish to edit, and enter Program Edit mode.
- ② In <Program Edit>, use the PAGE/PART[◀][▶] keys or the CURSOR[◀][▶] keys to select the Control section, and press the [EDIT/ENTER] key.
- ③ Use the CURSOR[◀][▶] keys to select the parameter that you wish to edit, and use the [VALUE] knob or the [INC+][DEC-] keys to modify the value. For example if you select <Aftertouch VDF> and modify the value, you will notice that the tonal character becomes brighter or darker when you transmit aftertouch messages to the N1R by pressing down on the notes of your connected MIDI keyboard. Other means of control include pitch bend change messages and control change #1 messages.

Applying realtime controller edits to the sound

If you have used the four knobs in Performance Play mode to modify the sound, and wish to apply these changes to the program sound that you will edit, simultaneously press the [INC+] and [DEC-] keys at the <Program Edit> display (i.e., immediately after entering Program Edit mode).

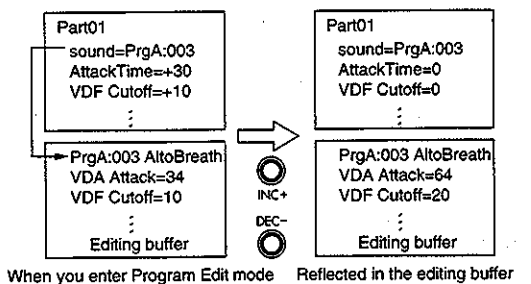

Saving program sound settings

- ① In Program Edit mode, press the [WRITE] key. ② Use the [VALUE] knob or the [INC+][DEC-] keys to select the save destination number. ③ Press the [WRITE] key to execute. To save effect settings, ① press the [WRITE] key in Effect Edit mode. ② Use the [VALUE] knob or the [INC+][DEC-] keys to select the save destination number. At this time, make sure to save to effect bank u for program sounds. ③ Press the [WRITE] key to execute.
- ⚠ Be aware that when you execute the Write operation, the original data in the writing destination will be overwritten and lost. If you press the [EXIT] key or exit this mode by pressing another mode key, your edits will be lost.

Basic operation

5. Effect Edit mode

Effects can be used to modify the sound in various ways or to simulate an acoustic sound field. On the N1R, you can make effect settings for program sounds, for combination sounds, or for performances. Effect editing in Performance Play mode and Multi mode is the same.

Effect structure

The N1R contains two digital effect processors. For each effect processor (EFFECT 1 and 2) you can select one of 48 types of effects such as reverb, delay, flanger, distortion, and exciter.

In Effect Edit mode you can change the effect type or modify the specific settings within the effect.

The 48 effect types are numbered individually. Types 1-37 and 48 are single effects, types 38-39 are serial-connected effects, and 40-47 are parallel-connected effects. By using parallel-connected effects, you can simultaneously use up to four types of independent effect.

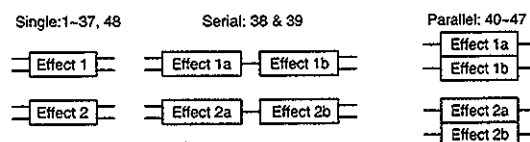

The two effects can be connected in one of six different ways (effect placement): SERIAL, PARA.1 (parallel 1), PARA.2 (parallel 2), PARA.3 (parallel 3), SERIS (serial sub), and PARA.S (parallel sub) (refer to p.59).

The N1R provides 728 preset effect programs and 200 user effect programs. There are also 32 effect programs which can be specified for each performance, and these are organized in the following ten banks.

P, U, A, B, C, u, a, b, c, G

Effect bank name	Contents
P	The effect written in the performance (Effect number cannot be selected)
U	User effect for bank "CmbU"
A	Preset effect for bank "CmbA"
B	Preset effect for bank "CmbB"
C	Preset effect for bank "CmbC"
u	User effect for bank "PrgU"
a	Preset effect for bank "PrgA"
b	Preset effect for bank "PrgB"
c	Preset effect for bank "PrgC"
G	Effect for GM or GM variation sounds

An effect program can be created by using both effects 1 and 2 and editing various parameters, and 100 such programs can be stored in bank U for combination sounds, 100 more programs in bank u for program sounds, and 32 more programs for performances.

If an initialization message such as GM System On is received in Multi mode, the effect section will automatically default to the following settings.

Effect 1: 01 Hall
Effect 2: 19 Chorus 1
Placement: PARA.3

About effect operation

The effect settings which were made most recently will take priority and override the earlier settings, in the following order: effect settings for a program sound, effect setting for a combination sound, effect settings for Performance Play mode or Multi mode. In the case of a combination sound, the effect settings of the program assigned to each timbre will be ignored, and the effect settings of the combination itself will be used. Immediately after a performance is selected, the effect settings of the performance itself will be applied.

In Performance Play/Edit modes, changing the program/combination sound that is selected for the Upper part will cause the effects to change accordingly. The effects that will be applied will be the effect number that was specified/saved in Program Edit mode or Combination Edit mode. In Multi mode, changing the program/combination sound of each part will not cause the effects to change accordingly. In either case, selecting a performance will switch to the effects that were saved in Program Edit mode.

Basic operation in Effect Edit mode

- To enter Effect Edit mode, press the [EDIT/ENTER] key from one of the following states.
 - When the Effect Edit mode icon is selected in the <Edit Menu> (i.e., when the cursor is on the icon).
 - In Multi mode when the bank or effect number of the currently used effect is selected (i.e., when the cursor is located there).
 - In Program Edit mode, Combination Edit mode or Performance Edit mode, when the bank or number of the effect used by that sound is selected (i.e., when the cursor is located there).



- Use the PAGE/PART[◀][▶] keys to change pages, and use the CURSOR[◀][▶] keys to select parameters.
- Use the [VALUE] knob or the [INC+][DEC-] keys to modify the parameter value.
- For details on saving your settings, refer to "Saving effect settings." To exit Effect Edit mode, press the [EXIT] key.

Effect editing

- As described in "Basic operation in Effect Edit mode," select the effect (program/combination sound, performance) that you wish to edit, and enter Effect Edit mode.
- Press PAGE/PART[◀] to select <Effect Placement>, and use the [VALUE] knob or the [INC+][DEC-] keys to set it to SERIAL.

With this placement setting, the sounds that are input to A and B will be processed by effect 1 and effect 2, and will be output from L/MONO and R. The sounds that are input to C and D will be mixed with the output of effect 1, then processed by effect 2 and output. A and B are the output from the panpot, and C and D are the output from send C and send D.

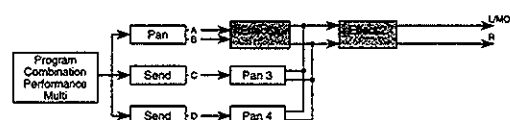

For other placements, refer to p.59 "Effect Edit mode."

- Use the CURSOR[◀][▶] keys to select <Effect 1 Type> and <Effect 1 Switch>. Use the [INC+][DEC-] keys or the [VALUE] knob to select an effect type for effect 1, and to switch the effect on/off. In the same way, make settings for <Effect 2 Type> and <Effect 2 Switch>.
- Use the PAGE/PART[◀][▶] keys to change pages, use the CURSOR[◀][▶] keys to select effect parameters, dynamic modulation, or output level etc., and use the [INC+][DEC-] keys or the [VALUE] dial to modify the values.
For explanations of the Effect Edit mode parameters, refer to p.59-p.70.

Saving effect settings

If you wish to save effects for a program sound or combination sound: In Effect Edit mode, press the [WRITE] key, and then use the [VALUE] knob or the [INC+][DEC-] keys to select the save destination number. At this time, be sure to save the effect settings in effect bank u for program sounds, or in effect bank U for combination sounds. Then, finally press the [WRITE] key to execute.

However, if you wish to save effect settings for a performance, press the [EXIT] key twice to exit Effect Edit mode after you finish editing the effect, and execute the Write operation in Program Edit mode.

Be aware that when you execute the Write operation, the original data in the writing destination will be overwritten and lost. If you press the [EXIT] key or exit this mode by pressing another mode key, your edits will be lost.

6. Drumkit Edit mode

In Drumkit Edit mode you can modify or create the drumkits which are the foundation of a drum program.

Drumkit structure

A drumkit is an oscillator which consists of an arrangement of percussion instrument sounds or drumsamples assigned to each key (referred to as an "instrument"), with settings for pitch, level, panpot, effect send level, and attack time etc.

In Program Edit mode, set <Oscillator Mode> to DRUMS, and set <Drumkit Select> to select either a preset drumkit or a user drumkit. This allows you to play a drumkit as a program sound. You can make settings for VDF, VDA, and effects in the same way as when editing a multisample.

The N1R provides 37 preset drumkits and two user drumkits.

In Drumkit Edit mode you can assign a different instrument to each note to create your own drumkit, and save it as a user drumkit.

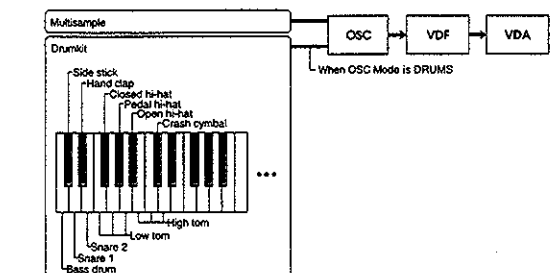

Basic operation in Drumkit Edit mode

- As described in "Basic operation in Program Edit mode," select the (drum) program that you wish to edit, and then enter Program Edit mode.
- In <Program Edit>, press the PAGE/PART[◀] key or the CURSOR[◀] key to select the OSC section, and press the [EDIT/ENTER] key.
- Press the CURSOR[◀] key to select <Oscillator Mode>, and use the [VALUE] knob or the [INC+][DEC-] keys to select DRUMS. If you wish to start your editing with a specific drumkit, press the CURSOR[▶] key and select the desired drumkit in <Drumkit Select>.
- Press the [EDIT/ENTER] key to enter Drumkit Edit mode.
- Use the CURSOR[◀][▶] keys to select the parameters of each instrument, and use the [VALUE] knob or the [INC+][DEC-] keys to modify the values.
- To move to another instrument, use the PAGE/PART[◀][▶] keys.

By holding down the [EDIT/ENTER] key and press-

Basic operation

ing a note on your keyboard, you can select the instrument which is assigned to that note.

- ⑦ Use the CURSOR[◀][▶] keys to select the parameter that you wish to edit, and use the [VALUE] knob or the [INC+][DEC-] keys to modify the value.

In Drumkit Edit mode, the LCD screen will show a diagram of the keyboard. The small downward pointing triangle above this keyboard corresponds to the note name displayed in the line immediately above, and indicates the note which you are currently editing.



Arranging drumsamples

- ① As described in "Basic operation in Drumkit Edit mode," select the (drum) program that you wish to edit, and then enter Program Edit mode.
- ② Hold down the [EDIT/ENTER] key, and play the note (i.e., transmit the note number) which corresponds to the instrument that you wish to edit.
- ③ Press the CURSOR[◀] key to select <Drumsample Select>, and use the [VALUE] knob or the [INC+][DEC-] keys to select the drumsample that will be assigned to this note. Play the keyboard and notice that the drumsample assigned to that note has now changed.
- ④ Next, press the CURSOR[▶] key to select parameters that determine the volume level, pitch, panpot, how the note will be sounded, and how the tonal character will change, and use the [VALUE] knob or the [INC+][DEC-] keys to modify the parameter values.

For details on instrument parameters, refer to "Drumkit Edit mode" (p.57) in the Reference section.

Saving a drumkit

- ① In Drumkit Edit mode, press the [WRITE] key, ② use the [VALUE] knob or the [INC+][DEC-] keys to specify the save destination number, and ③ press the [WRITE] key to execute.

⚠ Be aware that when you execute the Write operation, the original data in the writing destination will be overwritten and lost. If you press the [EXIT] key or exit this mode by pressing another mode key, your edits will be lost.

7. Multi mode

Unlike Performance Play mode, which is intended mainly for taking advantage of the performance functions, Multi mode should be used when you require the N1R to work as a multi-timbral MIDI tone generator for receiving multiple tracks of MIDI data from a sequencer, etc.

The structure of Multi mode

As in Performance Play mode, you can assign any one of 1269 program sounds (including programs which use a drumkit) or 402 combination sounds to each of up to 32 parts, and play them.

For each part, you can specify the sound, and various parameters such as volume and panpot.

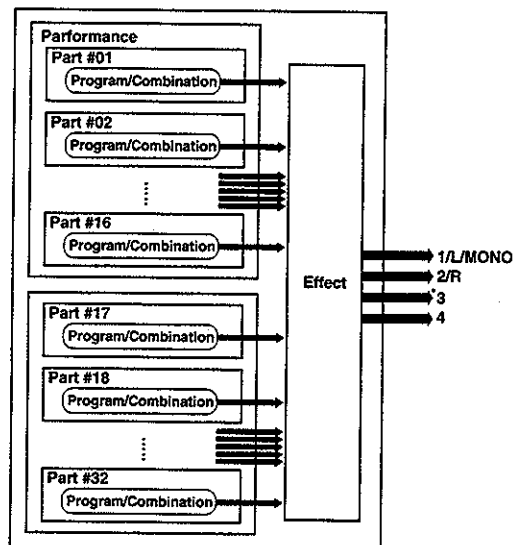

⚠ The settings of Multi mode parts 1-16 can be saved as a performance. However if an initialization message such as GM System On, GS Reset, or XG System On is received, these settings will be cleared to their default (initial) values.

When a MIDI system exclusive message such as GM System On, XG System On, or GS Reset is received, or when the Global mode <Initialize> GM Mode On, N-Reset(R) or N-Reset(Y) is executed, the N1R will be set to the following settings. These are the settings when the Global mode <Bank Map Type> is set to Default.

With the Default setting	
Rx.MIDI Ch.	Parts 01-16=A01-A16, Parts 17-32=B01-B16
Program	GM-a:001 Piano 1 (except for parts 10 and 26) rDrum:001 STANDARD (Parts 10, 26)
Effect	A:001 Rev/Cho
Volume	100
Expression	127
Panpot	CNT
Key Shift	+00
Rev.Send	40
Cho.Send	0

Part Mode	NORM (except for parts 10 and 26) MDrm1 (Parts 10) MDrm3 (Parts 26)
MONO/POLY	POLY
FineTune	+00
Note Window	C-1-G9
Velocity Window	001-127
ModWheel P.ModInt	10
PitchBend Range	+02
Portamento Switch	OFF
Portamento Time	0

If the Global mode <Bank Map Type> it set to 05R/W, the Program only will be set as follows, and the other settings will be the same as in the table above.

Program	GM-b:001 Piano (except for parts 10 and 26) kDrum:001 GMkit (Parts 10, 26)
---------	---

Basic operation in Multi mode

- ① Press the [MULTI/PERFORM.] key to enter Multi mode.
Each time the [MULTI/PERFORM.] key is pressed, you will alternate between Performance Play mode and Multi mode.
The settings of the currently selected performance will be valid for parts 1-16. For details on the applicable parameters, refer to p.21.
- ② Use the PAGE/PART[◀][▶] keys to select the desired part.
- ③ Use the CURSOR[◀][▶] keys to select the sound number or sound bank, and use the [VALUE] knob or the [INC+][DEC-] keys to select the sound. The bank can also be switched by pressing the BANK [COMBI] or [PROG] keys.
- ④ Finally, use the CURSOR[◀][▶] keys to select parameters such as the receive MIDI channel, key shift (transposition), volume, panpot, or effect, and use the [VALUE] knob or the [INC+][DEC-] keys to modify the parameter values.

About voices, parts, and MIDI channels

The N1R is able to play a total of 64 voices simultaneously. If more than 64 voices are requested at one time, the oldest currently-sounding voices will be turned off in succession. This means that caution is necessary when you are playing multiple parts simultaneously, in particular if you are using combination sounds which use many voices.

On the N1R, a unit which produces sound for a single note is referred to as a voice. Program sounds can be either single oscillator or double oscillator, and double oscillator programs will use two voices to play each note. Since combination sounds can use two or more of these program sounds, playing one note can use up to 16 voices.

A MIDI receive channel can be specified independently for each of the N1R's 32 parts. On the N1R, you can select from MIDI channels A1-A16 and B1-B16. The

MIDI channel of the transmitting device (computer or sequencer etc.) must be set to match the MIDI channel of the N1R part that you intend to play.

For details on the MIDI messages that can be received, refer to p.86 "Control using MIDI," "MIDI messages," and "MIDI implementation chart."

Effect settings

All of the sounds in Multi mode pass through two digital multi-effect processors, and is ultimately sent from the stereo (or 3 and 4) outputs. You can adjust the panning (A, B) with which each part is input to the effects, and adjust the send amounts (effect send C and D).

- ① Press the [MULTI/PERFORM.] key to enter Multi mode.
- ② Use the PAGE/PART[◀][▶] keys to select the part that you wish to edit, and use the CURSOR[◀][▶] keys to select <Panpot>, <C Send Level>, and <D Send Level>. Then use the [VALUE] knob or the [INC+][DEC-] keys to specify the panning A and B at which the sound will be input to the effects, and the send amounts C and D to the effects (refer to <Effect Placement> p.59).
- ③ Use the CURSOR[◀][▶] keys to select <Effect Bank Select> and <Effect Number Select>, and use the [VALUE] knob or the [INC+][DEC-] keys to select the bank and effect number of the desired effect program.
- ④ If you wish to modify the parameter values of the selected effect, press the [EDIT/ENTER] key to enter Effect Edit mode.
For the editing procedure in Effect Edit mode, refer to "Effect editing."

Saving Multi mode settings

If you wish to save the part parameter settings for parts 1-16 of Multi mode, you can save them in Part Edit mode or in Performance Edit mode (refer to p.23, p.35).

Basic operation

8. Part Edit mode

For each of the 32 parts of the N1R, you can make settings for various part parameters. Unlike the editing that is done in Program Edit mode or Combination Edit mode, editing in Part Edit mode creates only temporary changes (offset editing) to the original program or combination sounds used by each part. This means that the original sounds themselves are not actually modified.

Any temporary changes to the sound by using the realtime controllers will be cleared to the default values (initial values) when an initialization message such as GM System On, GS Reset, or XG System On is received.

Basic operation in Part Edit mode

- In Multi mode, press the [EDIT/ENTER] key to enter Part Edit mode. The following part edit menu will appear:

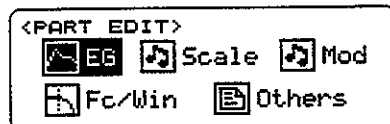

Part Edit parameters are grouped into five sections: EG (envelope generator), scale, MOD, filter/window, and others.

- Use the PAGE/PART [◀][▶] keys or the CURSOR [◀][▶] keys to move the cursor (the highlighted area) to the desired section and press [EDIT] once to access the parameter editing screen for that section. The following screen is an example of when EG is selected.

In the EG display shown above as an example, try modifying the attack time or decay time, and notice how the sound is affected.

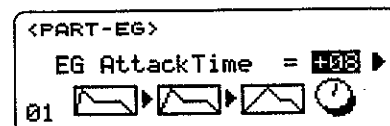

- In Part Edit mode, use the PAGE/PART [◀][▶] keys to switch parts, the CURSOR [◀][▶] keys to move the cursor to select a parameter, and the [VALUE] knob or the [INC+][DEC-] keys modify the value.

For details on the function of each parameter, refer to Reference guide, "9. Part Edit mode."

Saving Part Edit mode settings

After you have modified the part parameters for parts 1-16, you can save these settings as a performance. At this time, the effect settings you edited in Multi mode will also be saved.

- Press the [WRITE] key, 2 use the [VALUE] knob or the [INC+][DEC-] keys to select the save destination number, and 3 press the [WRITE] key to save the data.

Be aware that when you execute the Write operation, the original data in the writing destination will be overwritten and lost. If you press the [EXIT] key or exit this mode by pressing another mode key, your edits will be lost.

9. Global mode

In Global mode you can save (dump) various N1R parameters to an external data storage device or computer, and make settings which affect the operation of the entire N1R. You can also make settings which affect the N1R's display, select the MIDI messages which can be transmitted or received, and make memory protect settings.

Basic operation in Global mode

- Press the [GLOBAL] key to enter Global mode.



- Use the PAGE/PART [◀][▶] keys to move through the pages, use the CURSOR [◀][▶] keys to select parameters, and use the [VALUE] knob or the [INC+][DEC-] keys to modify the values.

For details on the function of each parameter, refer to Reference guide, "10. Global mode".

Saving Global mode settings

Since changes you make in Global mode are automatically saved when you move to another mode, the Write operation is not required.

If the power is turned off while you are still in Global mode, the modified settings will not be saved.

10. Demo mode

In this mode you can listen to demo songs which demonstrate the sounds and capabilities of the N1R (refer to p.9).

Saving (writing) and renaming

The edits that you make in Performance Edit mode, Program Edit mode, Combination Edit mode, Drumkit Edit mode, Effect Edit mode, Multi mode, and Part Edit mode can be saved to internal memory.

Write protect

To prevent data from being rewritten accidentally, the N1R provides a write protect setting (which prevents data from being written into memory). If you wish to write edited data, you must first use the following procedure to turn write protect OFF (so that the corresponding check box is unchecked).

- Press the [GLOBAL] key to move to Global mode.
- Use the PAGE/PART [◀][▶] keys to access the <Write Protect> page.

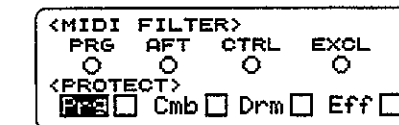

- Use the CURSOR [◀][▶] keys to select the check box located at the right of Prg, Cmb, Drm or Eff. Press the [INC+] key to add a check mark to the box. When a box is checked, it will be impossible to write data into the corresponding type of memory. Press the [DEC-] key to un-check the box, and allow data to be written.

Assigning a name (Rename)

You can assign a name to (or modify the existing name of) a program, combination, or effect program that you have edited.

- Make sure that the program or combination whose name you wish to assign (or modify) is selected. Use the PAGE/PART [◀][▶] keys to select the Rename parameter of the appropriate edit mode.



- Use the CURSOR [◀][▶] keys to highlight the character within the name that you wish to modify. Use the [VALUE] slider or the [INC+][DEC-] keys to select the desired character. Repeat this process to create the desired name. The following characters and symbols are available:

!	"	#	\$	%	&	'	()	*	+	,	-	.	/
0	1	2	3	4	5	6	7	8	9	:	;	<	=	>
@	A	B	C	D	E	F	G	H	I	J	K	L	M	N
P	Q	R	S	T	U	V	W	X	Y	Z	[\]	^
`	a	b	c	d	e	f	g	h	i	j	k	l	m	n
o	p	q	r	s	t	u	v	w	x	y	z	{		}
~														

Write (save) procedure

- If you wish to save a combination sound, program sound, drumkit, or effect program, turn the <Write Protect> setting (which prohibits writing into program memory) OFF (so that the check box has no check mark). (Refer to the above section Write Protect.)
- As desired, assign a name to (or modify the existing name of) the combination sound, program sound, or effect program (refer to the above section Rename).
- Press the [WRITE] key.



The current number will be automatically selected as the writing destination.

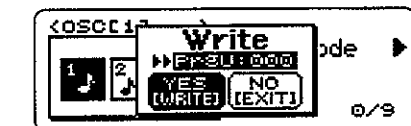

- Specify the save destination for the program sound, combination sound, effect program, or performance. Edited Program sounds can be saved only in bank PrgU, and edited combination sounds can be saved only in bank CmbU. Effect programs for combination sounds must be saved in bank U, and effect programs for program sounds must be saved in bank u. Use the [VALUE] knob or the [INC+][DEC-] keys to select the write destination number.
- Press the [WRITE] key once again to execute the Write operation. If you decide to cancel without writing, press the [EXIT] key. Alternatively, use the CURSOR [◀][▶] keys to select YES, and press the [EDIT/ENTER] key to execute the Write operation, or select NO and press the [EDIT/ENTER] key to cancel without writing.

Be aware that if you write data into a number which already contains a different program/combination sound or effect, the original sound or effect parameters that had been saved in that writing destination will be overwritten and lost.

Regarding verification at [EXIT]

When you edit any of the parameters in Program Edit mode, Combination Edit mode, or Effect Edit mode, the upper right of the LCD will indicate EDIT. If you press the [EXIT] key to attempt to leave the Edit mode when this EDIT indication is shown, the following popup window will appear. This menu lets you choose whether the data you modified will be saved to the user bank, or whether the changes you made will be discarded.



If at this point you press the [EDIT/ENTER] key to select CNCL, the popup window will disappear, and you can continue editing.

If you press the [WRITE] key to select YES, the edited data will be written into the selected number of the user bank. The number can be changed by using the [VALUE] knob or the [INC+][DEC-] keys.

If you press the [EXIT] key to select NO, the edited data will not be saved, and you will exit the Edit mode.

Restoring the factory settings

The data that is in memory when the N1R is shipped is referred to as the "factory preset data." The program sounds, combination sounds, performances, effects and drumkit settings in the N1R's internal memory can be restored to the factory preset condition.

If your sounds become changed or erased, you can use the following procedure to bring back the factory settings.

⚠ Be aware that when you perform this operation, all edited data and settings that you made will be lost. We recommend that if necessary, you save edited data on an external data storage device before executing the following procedure (refer to p.79).

- ① Press the [GLOBAL] key to enter Global mode.
- ② Use the PAGE/PART[◀][▶] keys to access the <Initialize> page.



- ③ Use the [VALUE] knob or the [INC+][DEC-] keys to select the type of data that you wish to restore to the factory settings (refer to p.79). As an example here, we will select Factory Preset so that all settings will be returned to their factory settings.

- ④ Press the [EDIT/ENTER] key, and a message will ask you to confirm the operation.

If you are sure that you wish to execute the operation, press the [EDIT/ENTER] key once again.

If you decide to halt this operation, press the [EXIT] key. The operation will be halted.

- ⚠ The Factory Preset operation does not initialize the <BPS Select> setting (refer to p.8, p.76).

Reference guide

1. Performance Play mode

<Performance Select>

01...32

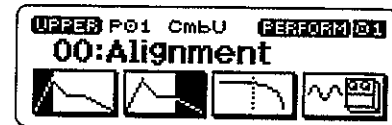

Selects the performance (refer to p.12, p.21).

<Part> (UPPER, LOWER)

P01...P16

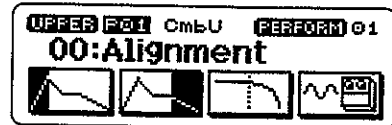

Selects the part which you will play.

<Bank> (UPPER, LOWER)

CmbU, A, B, C, PrgU, A, B, C, GM-b, GM-a,
r:01...r:40, r:CM, y:01...y101, ySFX, yDr1, yDr2,
rDrm, kDrm, ****



Selects the bank that you will play (refer to p.20).

<Program Select> (UPPER, LOWER)

000...099 (CmbU, A, B, C, PrgU, A, B, C)
001...128 (for banks other than the above)



Selects the program or combination sound.

In Performance Play/Edit modes, changing the program or combination will set the Bend Range of the part to "PRG." (The Part Edit mode item Mod <Part Pitch Bend Range> BNDWHL will be set to "PRG.")

<Control knob #1 value>

Value will depend on the parameter specified for the knob

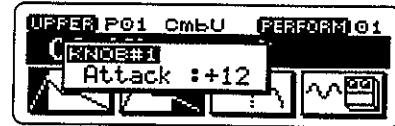

This displays the value of the parameter assigned to control knob 1. Use the knob to modify the value.

⚠ Only part parameters are edited by the control knobs. Program parameters are not edited. (If you want these settings to be reflected in the program parameters, refer to p.29.)

<Control knob #2 value>

<Control knob #3 value>

<Control knob #4 value>

(Same as Control knob #1)

2. Edit Menu

<Edit Menu>

Combi, prog, Perform, Effect



Selects the mode in which you wish to edit: Performance Edit mode, Combination Edit mode, Program Edit mode, or Effect Edit mode.

⚠ To enter Drumkit Edit mode, set the oscillator mode to DRUMS in Program Edit mode, and then press the [EDIT/ENTER] key (refer to p.31).

3. Performance Edit mode

PERFORM-COMMON 1

<Effect Thru Switch>

(Effect on), (Thru)



When you press the [INC+] key to select "●," the effect will be bypassed.

⚠ This setting is not saved as part of a performance.

<Effect Bank>

P, U, A, B, C, u, a, b, c, G

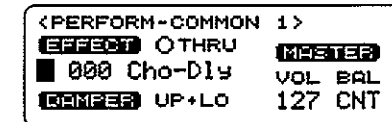

Changes the bank of the effect used by the current performance (refer to p.30).

<Effect Program>

000...099 (other than bank G)
001...128 (G bank only)

Changes the program number of the effect used by the current performance.

A number cannot be selected when the <Effect Bank> is P.

In Performance Play mode, changing the sound selected for the upper part will also cause the effect to change in tandem with the sound. The effect number specified in Program Edit or Combination Edit will be selected. In Multi mode, the effect will not change in tandem with the sound.

<Damper Assign>

UP+LO, LOWER, UPPER

When the Global mode <Single-channel Layer/Split> is on and the [LAYER/SPLIT] key is on, receiving a control change #64 (press the damper pedal) on the MIDI channel of the Upper part will apply the damper effect to the Upper/Lower parts.

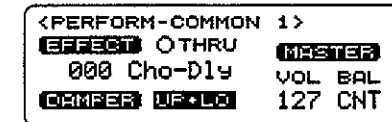

UP+LO:

The damper will apply to both parts.

LOWER:

The damper will apply only to the Lower part.

UPPER:

The damper will apply only to the Upper part.

<Master Volume>

Adjusts the volume of the entire performance.

In Multi mode, this will adjust the volume of all parts. In Performance Play/Edit modes, this is used to adjust the volume balance etc. between each performance. In Multi mode, this is used to create fade-in/out effects during playback. This parameter can be controlled using the MIDI system exclusive message Master Volume.

(Refer to "Universal exclusive messages" at the end of the manual.)

<Master Balance>

This shifts the panpot settings of the entire performance.

In Multi mode, the panpot of all parts will be shifted. This will have no effect on parts which are set to RND or OFF.

This parameter can be controlled using the MIDI system exclusive message Master Balance. (Refer to "Universal exclusive messages" at the end of the manual.)

PERFORM-COMMON 2

<Upper Part Number>

01...16



Specifies the part number of the Upper part.

<Lower Part Number>

01...16

Specifies the part number of the Lower part.

<Performance Octave>

-2, -1, 0, +1, +2



Transposes the Upper part and Lower part in Performance Play mode by the specified number of octaves. +1 will raise the pitch one octave, and +2 will raise the pitch two octaves. Negative (-) settings will lower the pitch. The location of the split point will not be affected.

⚠ This applies only to the Upper and Lower parts in Performance Play/Edit modes, and does not affect the other parts or Multi mode.

<Split point>**A0...C8**

Specifies the key (note number) at which the Upper and Lower parts will be divided when the Single-channel Split function is on.

The note specified here and all higher notes will be sounded by the Upper sound.

- ◇ This parameter can also be set by holding down the [EDIT/ENTER] key and pressing a note on your keyboard (i.e., receiving a note number).

KNOB-ASSIGN**<Control knob #1 Type>**

?, V DFA ATTACK, V DFA RELEASE, V DFA DECAY, V DF CUTOFF, EFFECT D.MOD, Lo:Up Balance, PAN POT, Porta TIME, FX.1 SEND, FX.2 SEND, Volume, Express, Mod.2, Mod.3, CTRL#000...CTRL#095

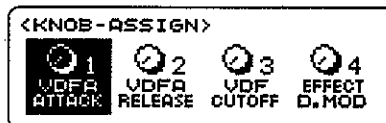

Specifies the parameter which will be controlled by control knob 1.

The parameter that you specify here will be assigned to the Realtime Controller [ASSIGN 1/] knob of Performance Play mode. The specified parameter will function when the [SELECT] key has been pressed to make the third LED light.

?:
No function

V DFA ATTACK:

Adjusts the attack times of the VDF and VDA EGs. The Part parameter EG Attack Time will be edited. Refer to p.72 <EG Attack Time>.

Control change #73 will be transmitted from MIDI OUT and TO HOST.

V DFA RELEASE:

Adjusts the release times of the VDF and VDA EGs. The Part parameter EG Release Time will be edited. Refer to p.72 <EG Release Time>.

Control change #72 will be transmitted from MIDI OUT and TO HOST.

V DFA DECAY:

Adjusts the decay times of the VDF and VDA EGs. The Part parameter EG Decay Time will be edited. Refer to p.72 <EG Decay Time>.

Control change #75 will be transmitted from MIDI OUT and TO HOST.

V DF CUTOFF:

Adjusts the cutoff frequency. The Part parameter Cutoff Frequency will be edited. Refer to p.75 <Cutoff Frequency>.

Control change #74 will be transmitted from MIDI OUT and TO HOST.

EFFECT D.MOD:

Effects Dynamic Modulation will be controlled. Regardless of the Effect Dynamic Modulation Source

setting, the effect will apply at the depth specified by the Effect Dynamic Modulation Intensity setting.

This will apply to both effects 1 and 2. Refer to p.60 <Effect 1 Dynamic Modulation Intensity>.

Control change #12 will be transmitted from MIDI OUT and TO HOST.

Lo:UP BALANCE:

Adjusts the volume balance between the sounds of the upper part and the lower part.

▲ In cases other than layer or split, setting this to the Lower side will mean that no sound will be heard.

PANPOT:

Adjusts the panpot.

This edits the Part parameter Panpot.

Refer to p.71 <Panpot>.

Control change #10 will be transmitted from MIDI OUT and TO HOST.

Porta TIME:

Adjust the portamento time.

This edits the Part parameter Portamento.

Refer to p.76 <Portamento Time>.

Control change #5 will be transmitted from MIDI OUT and TO HOST.

FX1 SEND:

Adjusts effect C send.

This edits the Part parameter C Send Level. Refer to p.71 <C Send Level>.

Control change #91 will be transmitted from MIDI OUT and TO HOST.

FX2 SEND:

Adjusts effect D send.

This edits the Part parameter D Send Level. Refer to p.72 <D Send Level>.

Control change #93 will be transmitted from MIDI OUT and TO HOST.

Volume:

Adjusts the volume of the part.

This edits the Part parameter Volume.

Refer to p.71 <Volume>.

Control change #7 will be transmitted from MIDI OUT and TO HOST.

Express:

Adjusts the volume of the part.

The volume of the part is determined by the product of Expression and Volume. Refer to p.71 <Expression>.

Control change #11 will be transmitted from MIDI OUT and TO HOST.

Mod.2:

Applies the effect specified by MOD.2 of the Part Edit mode Mod section. Refer to p.73 <Part Pitch Bend Range> - p.74 <Part VDA LFO Depth>.

Control change #16 will be transmitted from MIDI OUT and TO HOST.

Mod.3:

Applies the effect specified by MOD.3 of the Part Edit mode Mod section. Refer to p.73 <Part Pitch Bend Range> - p.74 <Part VDA LFO Depth>.

Control change #17 will be transmitted from MIDI OUT and TO HOST.

CTRL#000...CTRL#095

The specified control change (#0-#95) will be transmitted from MIDI OUT and TO HOST. If the N1R is able to respond to the transmitted message, the corresponding change will occur in the sound.

The assignment you specify here and the value edited in the performance will be memorized when you write the performance.

<Control knob #2 Type>**<Control knob #3 Type>****<Control knob #4 Type>**

(Same as Control knob #1)

ARPEGGIATOR 1**<Arpeggio Types>****01...20**

Selects the arpeggiator pattern. 20 types are available.

01. UP	08. ARP 3	15. B-SOUL
02. DOWN	09. ARP 4	16. B-JAZZ
03. ALT1	10. ARP 5	17. D-TECHNO
04. ALT2	11. ARP 6	18. D-JUNGLE
05. RANDOM	12. B-TECHNO	19. D-FUNK
06. ARP 1	13. B-DANCE	20. D-R&B
07. ARP 2	14. B-FUNK	

<Arpeggio Switch>**OFF, ON**

Specifies whether or not the arpeggiator will be left on when the performance is changed.

Signal flow for arpeggiator ON/OFF

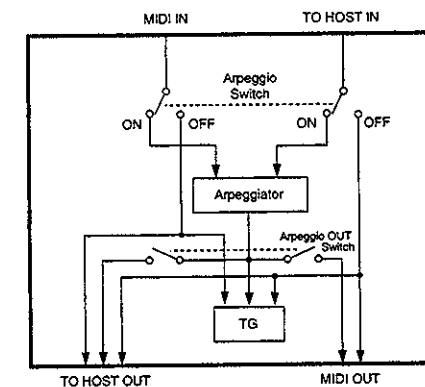

▲ The diagram shows the example of setting the Global parameter PC I/F TO PORT = Emulate, and MIDI Channel To Port A as the input for TO HOST IN.

<Arpeggio Octave>**1, 2, 3, 4**

Specifies the octave range of the arpeggio produced by the arpeggiator.

▲ If the note data transmitted from MIDI OUT would exceed 127 (or does not exceed 0), one octave will be subtracted (or added) before the note is transmitted.

<Latch/Key Sync>**OFF, LATCH, K.SYNC, L&K.S**

Specifies how the arpeggio will be controlled by the keyboard. Operation of each type is as follows.

(A) OFF

The arpeggio will begin playing at the specified speed regardless of the timing at which the keys are pressed.

(B) LATCH

The arpeggio will continue repeating even after the keys are released.

(C) K.SYNC

While with setting (A) the arpeggio will play without regard to the timing at which the keys are pressed, this setting causes the arpeggio to start at the moment that the keys are pressed.

(D) L&K.S

The settings of (B) and (C) will both apply.

If you wish to synchronize the beats of the arpeggio with an external sequencer, select OFF or LATCH.

<Arpeggio Speed>**40...240 [BPM]**

Specifies the speed (tempo) of the arpeggio. This also specifies the tempo of the MIDI clock that is transmitted from MIDI OUT.

▲ If Global mode <Clock Source> is set to MIDI or PCIF so that the arpeggiator is operating on an external clock, this setting will be ignored.

ARPEGGIATOR 2**<Arpeggio Step Base>**

♪ (quarter note), ♪₃ (quarter note triplet), ♪ (eighth note), ♪₃ (eighth note triplet), ♪ (16th note), ♪₃ (16th note triplet)

```
<ARPEGGIATOR 2>
STEPBASE: ♪ SORT: ON
VEL: 127 ZONE: LOWER
GATE: 080% SWING: +00
```

Specifies the note value for each step of the arpeggio.

<Arpeggio Velocity>

001...127, KEY, STEP

Specifies the strength (velocity) of the arpeggio notes. With a setting of 001-127, the notes of the arpeggio will sound at the specified velocity. With a setting of KEY, the velocity with which you play the keyboard will be used.

With a setting of STEP, the velocity that has been specified for each step will be used.

<Arpeggio Gate>

001...100 [%], STEP

Specifies the note length (gate time) of each step of the arpeggio. With a setting of 100%, notes will be the same length as the step time. With a setting of 50%, they will be half the gate time.

With a setting of STEP, the step time that has been specified for each step will be used.

<Arpeggio Sort>

OFF, ON

Specifies whether the arpeggio will be sorted. With a setting of ON, the notes you press will be sorted in order of their pitch, and played. With a setting of OFF, the notes will be played in the order in which they were pressed.

<Arpeggio Zone>

LOWER, UPPER, ALL

Specifies the part which the arpeggiator will use when the Split or Layer function (refer to p.13) is turned on.

(A) LOWER

When the Split function is on, the arpeggiator will function in the keyboard area below the split point.

When the Layer function is on, the arpeggiator will function only for the Lower part.

(B) UPPER

When the Split function is on, the arpeggiator will function in the keyboard area above the split point.

When the Layer function is on, the arpeggiator will function only for the Upper part.

(C) ALL

The arpeggiator will function for both the Lower and Upper parts.

<Arpeggio Swing>

-99...00...+99 [%]

Moves the timing of even-numbered steps forward or backward to modify the groove.

4. Combination Edit mode**<Timbre Bank Select>**

PrgU, A, B, C, GM-b, GM-a, r:01...r:40, r:CM, y:01...y101, ySFX, yDr2, rDrm, kDrm

```
CmbU:000 Alignment
PrgU:000 Expansions
Volume = 100
01 [T][T][T][T][T][T][T]
```

Selects the sound bank for each timbre program in the combination.

<Timbre Program Number Select>

000...099 (for sound banks PrgU, A, B, C)
001...128 (for sound banks other than the above)

```
CmbU:000 Alignment
PrgU:000 Expansions
Volume = 100
01 [T][T][T][T][T][T][T]
```

Selects the program number for each timbre program in the combination.

<Timbre Volume>

000...127

```
CmbU:000 Alignment
PrgU:000 Expansions
Volume = 100
01 [T][T][T][T][T][T][T]
```

Specifies the volume for each timbre program in the combination.

<Timbre Panpot>

RND, L63...CNT...R63, OFF

```
CmbU:000 Alignment
PrgU:000 Expansions
PanPot = 000
01 [L][L][L][L][L][L][L]
```

Adjusts the panpot of each timbre. With a setting of CNT, that timbre will be heard from the center. With a setting of RND, the sound will be heard from a random location each time a note is played. This setting also functions as the balance for the amount sent to the effect section (refer to p.59). When this is OFF, only C and D will be output from the program.

▲ The panpot value of the program parameter for each timbre program will be added to this value to determine the actual setting.

<Timbre Transpose>

-24...00...+24

```
CmbU:000 Alignment
PrgU:000 Expansions
Transpose = +00
01 [T][T][T][T][T][T][T]
```

Each timbre in the combination can be transposed in semitone steps.

<Timbre Fine Tune>

-50...00...+50

```
CmbU:000 Alignment
PrgU:000 Expansions
FineTune = +00
01 [T][T][T][T][T][T][T]
```

Adjusts the fine tuning of each timbre in the combination.

<Timbre C Send Level>

000...127

```
CmbU:000 Alignment
PrgU:000 Expansions
C SendLevel = 000
01 [L][L][L][L][L][L][L]
```

Specifies the amount of sound that will be sent from each timbre of the combination to the effect used by the combination.

This parameter will be multiplied by the Part C/D Send Level to determine the final amount of the effect.

The program parameter C/D Send Level of each timbre program will be ignored.

Please be aware that when a GM System ON message etc. is received, the part C (REV) send will be set to 40, and D (CHO) send will be set to 00.

<Timbre D Send Level>

000...127

```
CmbU:000 Alignment
PrgU:000 Expansions
D SendLevel = 000
01 [L][L][L][L][L][L][L]
```

As with C Send Level, this specifies the amount of sound that will be sent from each timbre to the effect.

<Note Window Bottom>

C-1...G9

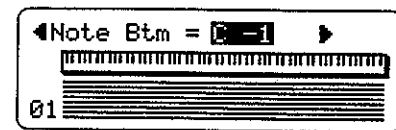

Specifies the lowest note for which each timbre in the combination will sound.

This can also be specified by holding down the [EDIT/ENTER] key and pressing a note.

<Note Window Top>

C-1...G9



Specifies the highest note for which each timbre in the combination will sound.

This can also be specified by holding down the [EDIT/ENTER] key and pressing a note.

By setting the note window, you can cause a program to sound only in a specified range of the keyboard.

<Velocity Window Bottom>

001...127

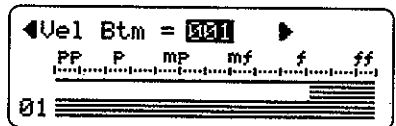

Specifies the minimum velocity (MIDI data that indicates the force with which a note was played) for which each timbre in the combination will sound.

<Velocity Window Top>

001...127

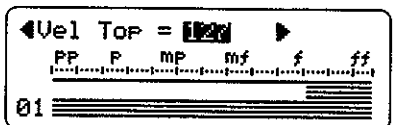

Specifies the maximum velocity for which each timbre in the combination will sound.

By setting the velocity window, you can cause a program to sound only for notes which are played with a specific range of force.

<Receive Note On>

ON, OFF



Specifies whether or not MIDI note-on messages will be received. If this parameter is OFF, the timbre will be as though it were muted, and will not sound.

<Receive Control Change>

ON, OFF

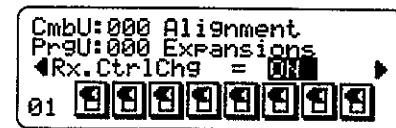

Specifies whether or not MIDI control change messages will be received. If this parameter is OFF, the timbre will not receive MIDI control change messages.

<Receive Pitch Bend>

ON, OFF



Specifies whether or not MIDI pitch bend messages will be received. If this parameter is OFF, the timbre will not receive MIDI pitch bend messages.

<Receive Aftertouch>

ON, OFF



Specifies whether or not MIDI aftertouch messages will be received. If this parameter is OFF, the timbre will not receive MIDI aftertouch messages.

<Receive Damper>

ON, OFF



Specifies whether or not MIDI damper messages will be received. If this parameter is OFF, the timbre will not receive MIDI damper messages.

<Receive Portamento>

ON, OFF



Specifies whether or not MIDI portamento messages will be received. If this parameter is OFF, the timbre will not receive MIDI portamento messages.

<Effect Bank Select>

U, A, B, C, u, a, b, c, G

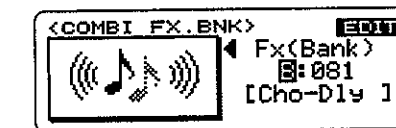

Specifies the bank of the effect which the combination sound will use (refer to p.30). Here it is not possible to select "P."

From this display page, you can press the [EDIT/ENTER] key to enter Effect Edit mode.

<Effect Number Select>

001...128 (for effect bank G)

00...99 (for effect banks other than the above)



Selects the number of the effect which the combination sound will use.

From this display page, you can press the [EDIT/ENTER] key to enter Effect Edit mode.

<Combination Rename>

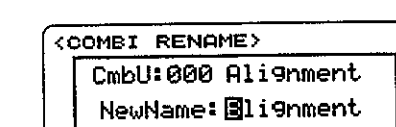

Here, you can modify the name of the combination. Use the CURSOR [◀][▶] keys to select the character that you wish to modify, and use the [VALUE] knob or the [INC+][DEC-] keys to modify the character.

The following characters and symbols can be used:

	!	"	#	\$	%	&	'	()	*	+	,	-	.	/
0	1	2	3	4	5	6	7	8	9	:	;	<	=	>	?
@	A	B	C	D	E	F	G	H	I	J	K	L	M	N	O
P	Q	R	S	T	U	V	W	X	Y	Z	[]	^	_	
`	a	b	c	d	e	f	g	h	i	j	k	l	m	n	o
F	g	r	s	t	u	v	w	x	y	z	{		}	+	=

Reference guide

Combination Edit

5. Program Edit mode

<Program Edit>

OSC, Pitch LFO, Pitch EG, VDA, VDF LFO, VDF EG, VDA LFO, VDA EG, Fx (Effect), Control, Rename

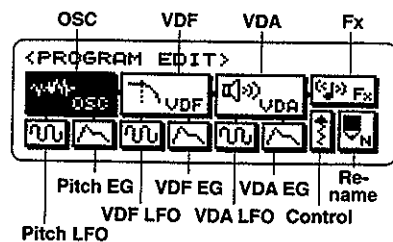

Selects the section that you wish to edit (refer to p.26).

- ◆ Press the [EDIT/ENTER] key to enter the section you selected.

OSC

<Oscillator Mode>

SINGLE, DOUBLE, DRUMS



This specifies whether one or two oscillators will be used, or whether a drumkit oscillator will be used. If you select SINGLE, one set of oscillator, filter and amplifier will be used. In this case, the N1R will be able to play a maximum of 64 notes simultaneously.

If you select DOUBLE, two sets of oscillators, filters and amplifiers will be used, allowing you to combine two different sounds (or the same sound) to be played as one sound, so that a richer and more sophisticated sound can be created. However in this case, the N1R will be able to play a maximum of 32 notes simultaneously.

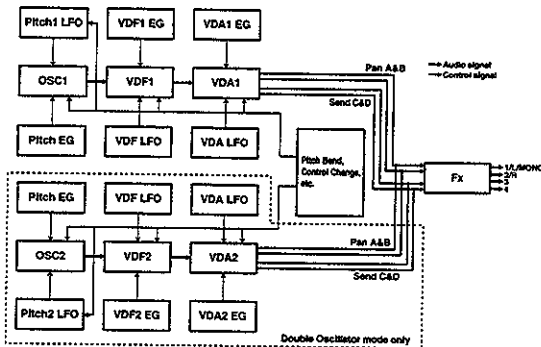

- ◆ When DOUBLE is selected, you can press the [EDIT/ENTER] key in subsequent edit pages to switch the indicator located in the LCD between [1] and [2]. This indicates which of the two sets of oscillators, filters and amplifiers you are currently editing. I.e., oscillator, filter and amplifier settings with the same number ([1] or [2]) belong to the same system.

(DOUBLE)



If you select DRUMS, you can choose a drumkit. Unlike a conventional multisample, a drumkit plays a different percussion instrument sound for each note.

- ◆ When the oscillator mode is set to DRUMS, you can press the [EDIT/ENTER] key to enter Drumkit Edit mode, and edit the various parameters of the drumkit (refer to p.57).

<Multisample Select>

000...562

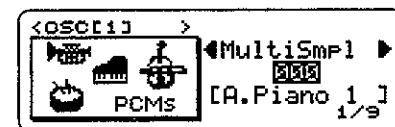

Selects the multisample (refer to p.115) that you wish to use. (When OSC Mode is "SINGLE" or "DOUBLE")

<Drumkit Select>

000...038

Selects the drumkit (refer to p.105) that you wish to use. (When OSC Mode is "DRUMS")

<Octave Select>

32', 16', 8', 4'



Adjusts the pitch of the oscillator in one-octave units. 8' is the standard pitch. If you are using a drumkit oscillator, set this to 8'.

<Oscillator Level>

000...127



Adjusts the volume of the oscillator.

<Key Transpose>

-12...00...+12

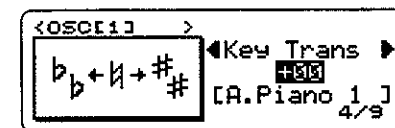

Adjusts the pitch of the oscillator in semitone steps.

<Fine Tune>

-99...00...+99



Makes fine adjustments to the pitch of the oscillator. When OSC Mode is DOUBLE, this parameter is also used to create detuning between oscillators 1 and 2.

<Velocity Window Bottom>

001...127

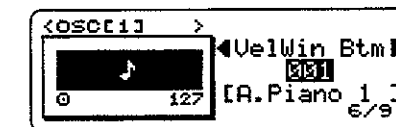

Specifies the lower limit of the velocity for which the oscillator will sound.

<Velocity Window Top>

001...127

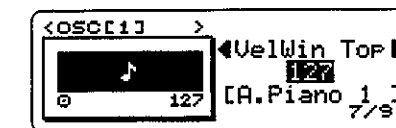

Specifies the upper limit of the velocity for which the oscillator will sound.

<Delay Start>

000...127

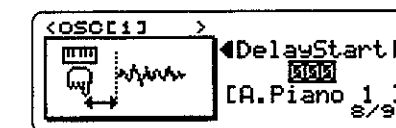

Specifies the time from when the note-on message is received until the oscillator actually begins to sound.

<Pitch Slope>

-1.0...0.0...+2.0

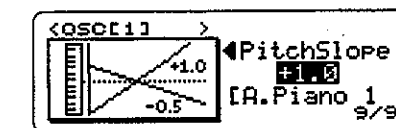

Specifies how the pitch will be related to the keyboard position. When this parameter is set to +1.0, the pitch will rise one octave as the note number increases by 12 (i.e., for every 12 notes). This is the normal setting. The following diagram shows how the value of this parameter will affect the way in which the keyboard determines the pitch.

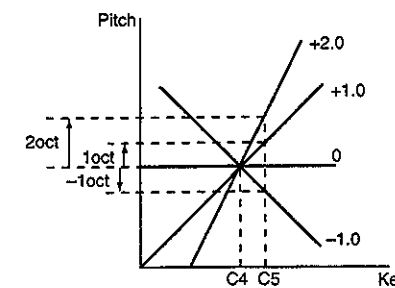

PITCH LFO**<Pitch LFO Waveform>**

TRIANGLE, SAW UP, SAW DOWN, SQUARE 1, SQUARE 2, RANDOM



Selects the waveform which the pitch LFO will use.

<Pitch LFO Frequency>

000...127



Specifies the frequency of the pitch LFO waveform.

<Pitch LFO Intensity>

-128...000...+127



Specifies the depth (strength) of the pitch LFO effect.

<Pitch LFO Delay>

000...127



Specifies the time from note-on until when the pitch LFO begins to take effect.

<Pitch LFO Fade-in Time>

000...127



After the Delay Time has elapsed, specify the time from when the LFO begins to take effect until the specified intensity is reached.

<Pitch Bend Range>

-24...00...+24

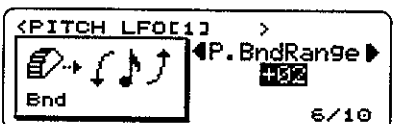

Specifies the range of pitch bend in semitones.

This parameter is valid only if the Part parameter <Part Pitch Bend Range> (p.73) is set to PRG.

<Modulation Wheel Pitch LFO Intensity>

000...127

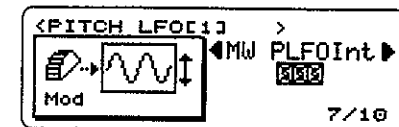

Specifies the depth with which control change #1 (the modulation wheel) will control the pitch LFO.

This value will be added to the value of the Part parameter <Part Pitch LFO Depth>.

<Modulation Wheel Pitch LFO Speed>

000...127



Adjusts the amount of control that control change #1 (the modulation wheel) will have on the frequency of the Pitch LFO.

This value is added to the value of the Part parameter <Part LFO Rate>.

<Aftertouch Pitch LFO Intensity>

000...127



Adjusts the amount of control that aftertouch will have on the Pitch LFO modulation depth.

This value is added to the value of the Part parameter <Part Pitch LFO Depth>.

<Aftertouch Pitch LFO Speed>

000...127



Adjusts the amount of control that aftertouch will have on the frequency of the Pitch LFO.

This value is added to the value of the Part parameter <Part LFO Rate>.

PITCH EG**<Pitch EG Start Level>**

-128...000...+127

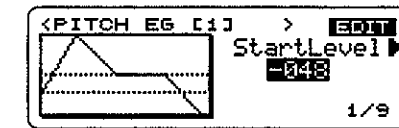

Specifies the pitch at the instant of note-on.

This value is added to the value of the Part parameter <Pitch EG Start Level>.

<Pitch EG Attack Time>

000...127



Specifies the time from note-on until the attack level is reached.

This value is added to the value of the Part parameter <Pitch EG Attack Time>.

<Pitch EG Attack Level>

-128...000...+127

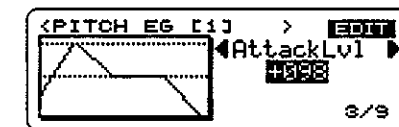

Specifies the pitch after the attack time has elapsed.

<Pitch EG Decay Time>

000...127



Specifies the time over which the pitch will return to the standard pitch, after the attack time has elapsed.

<Pitch EG Release Time>

000...127



Specifies the time from note-off until the release level is reached.

This value is added to the value of the Part parameter <Pitch EG Release Time>.

<Pitch EG Release Level>

-128...000...+127

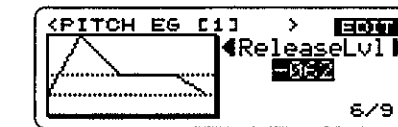

Specifies the pitch after the release time has elapsed.

This value is added to the value of the Part parameter <Pitch EG Release Level>.

<Pitch EG Intensity>

-128...000...+127

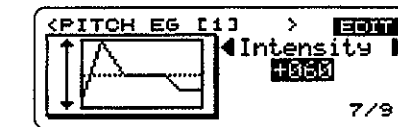

Specifies the depth (strength) of the pitch EG effect.

<Pitch EG Intensity Velocity Sensitivity>

-128...000...+127

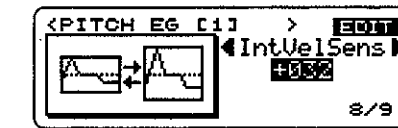

Specifies how velocity will affect the way in which the pitch EG changes.

<Pitch EG Time Velocity Sensitivity>

-128...000...+127



Specifies how velocity will affect the times of the pitch EG.

VDF

<Cutoff Frequency>

000...127



Specifies the cutoff frequency of the VDF (the brightness of the sound).

<Color Intensity>

000...127



This setting boosts the level in the region of the VDF cutoff frequency, adding a distinctive character to the sound.

For some types of multisample, the effect of this parameter may not be obvious.

<Color Velocity Sensitivity>

-128...000...+127

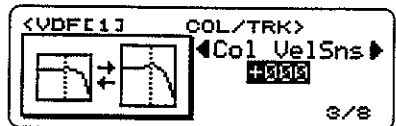

Specifies how velocity will affect the Color intensity.

<VDF Keyboard Tracking Mode>

OFF, LOW, HIGH, ALL



Specifies how keyboard tracking will be applied. <VDF Keyboard Tracking Key> specifies the key location at which keyboard tracking will occur. With a setting of OFF, keyboard tracking will not apply.

<VDF Keyboard Tracking Key>

C-1...G9



If the Keyboard Tracking Mode is LOW or HIGH, this parameter specifies the key at which tracking will begin. If the tracking mode is ALL, this parameter specifies the center key.

<VDF Keyboard Tracking Intensity>

-128...000...+127

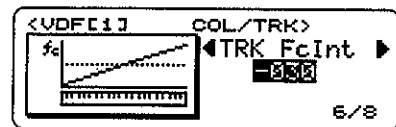

Specifies how the keyboard location will affect the VDF cutoff frequency.

<VDF Keyboard Tracking EG Time>

-128...000...+127



Specifies how the keyboard location will affect the various VDF EG times.

If this value is increased in the positive (+) direction, VDF EG times will be shorter when you play higher notes in the area specified by Keyboard Tracking Mode and Keyboard Tracking Key, causing the tone (brightness) of the sound to change more rapidly. When you play lower notes in this area, VDF EG times will be longer, causing the tone to change more slowly.

<VDF Keyboard Tracking EG Time Switch & Polarity (AT), (DT), (ST), (RT)>

OFF, ON(+), ON(-)



Specifies the direction of the change in VDF EG Attack Time (AT), Decay Time (DT), Slope Time (ST) and Release Time (RT) that will be produced by VDF keyboard tracking.

For each time, a setting of "+" will cause notes played above the Keyboard Tracking Key to have shorter times, and a setting of "-" will cause them to have longer times. With a setting of "OFF" there will be no effect.

This parameter specifies the direction (±) in which each of the four EG time parameters will change. The amount of change is determined by the value of the Keyboard Tracking EG Time parameter.

VDF LFO

<VDF LFO Waveform>

TRIANGLE, SAW UP, SAW DOWN, SQUARE 1, SQUARE 2, RANDOM



Selects the waveform which the VDF LFO will use.

<VDF LFO Frequency>

000...127



Specifies the frequency of the VDF LFO waveform.

<VDF LFO Intensity>

-128...000...+127

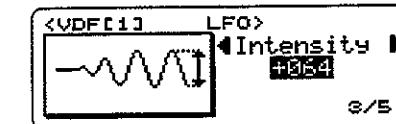

Specifies the depth (strength) of the VDF LFO effect.

<VDF LFO Delay>

000...127



Specifies the time from note-on until the VDF LFO begins to take effect.

<VDF LFO Fade-in Time>

000...127



After the Delay Time has elapsed and the LFO begins to take effect, this parameter specifies the time over which the specified Intensity is reached.

VDF EG

<VDF EG Attack Time>

000...127



Specifies the time from note-on until the Attack Level is reached.

<VDF EG Attack Level>

-128...000...+127

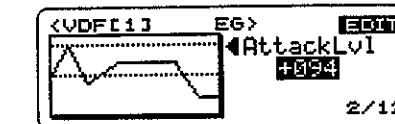

Specifies the VDF cutoff value that will be reached after the Attack Time.

<VDF EG Decay Time>

000...127

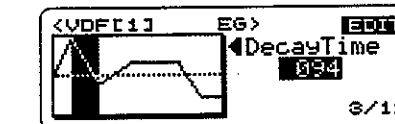

After the Attack Time has elapsed, this parameter specifies the time until the Break Point is reached.

<VDF EG Break Point>

-128...000...+127

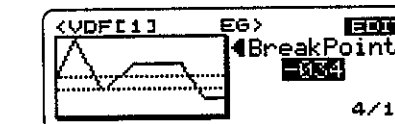

Specifies the VDF cutoff value that will be reached after the Decay Time.

<VDF EG Slope Time>

000...127

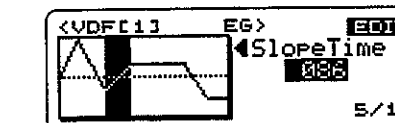

After the Decay Time has elapsed, this parameter specifies the time until the Sustain Level is reached.

<VDF EG Sustain Level>

-128...000...+127

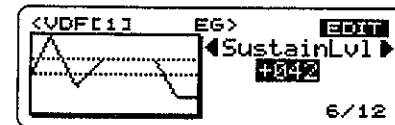

Specifies the VDF cutoff level that will be held after the Slope Time has elapsed until note-off.

<VDF EG Release Time>

000...127



Specifies the time from note-off until the Release Level is reached.

<VDF EG Release Level>

-128...000...+127



Specifies the VDF cutoff level that will be reached after the Release Time has elapsed.

<VDF EG Intensity>

-128...000...+127



Specifies the depth (strength) of the VDF EG effect.

<VDF EG Intensity Velocity Sensitivity>

-128...000...+127



Specifies how velocity will affect the VDF EG effect.

<VDF EG Time Velocity Sensitivity>

000...127



Specifies how velocity will affect the times of the <VDF EG Attack Time>, <VDF EG Decay Time>, <VDF EG Slope Time>, and <VDF EG Release Time> parameters.

The direction of change will depend on the positive or negative setting of the <VDF EG Time Velocity Sensitivity Switch & Polarity> parameter.

<VDF EG Time Velocity Sensitivity Switch & Polarity (AT), (DT), (ST), (RT)>

OFF, ON(+), ON(-)

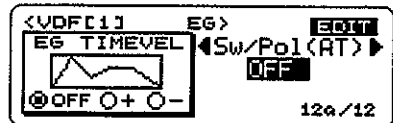

Specifies the direction of the effect that velocity will have on the times of the <VDF EG Attack Time>, <VDF EG Decay Time>, <VDF EG Slope Time>, and <VDF EG Release Time> parameters.

With a setting of "+," the corresponding VDF EG time will become shorter as you play more strongly, producing a more rapid change in tonal character. When you play softly, the VDF EG times will become longer, producing a slower change in tonal character.

With a setting of "-", the corresponding VDF EG time will become longer as you play more strongly, producing a slower change in tonal character. When you play softly, the VDF EG times will become shorter, producing a more rapid change in tonal character.

With a setting of OFF, velocity will have no effect on the times of these parameters.

The degree to which VDF EG times will change is specified by the <VDF EG Time Velocity Sensitivity> parameter.

VDA

<VDA Keyboard Tracking Mode>

OFF, LOW, HIGH, ALL



Specifies how keyboard tracking will be applied.

<VDA Keyboard Tracking Key> specifies the keyboard location at which keyboard tracking will be applied. With a setting of OFF, keyboard tracking will not apply.

<VDA Keyboard Tracking Key>

C-1...G9

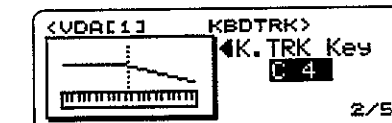

If the Keyboard Tracking Mode is LOW or HIGH, this parameter specifies the key at which tracking will begin. If the tracking mode is ALL, this parameter specifies the center key.

<VDA Keyboard Tracking Intensity>

-128...000...+127



Specifies how the keyboard location will affect the volume change produced by the VDA.

<VDA Keyboard Tracking EG Time>

-128...000...+127



Specifies how the keyboard location will affect the various VDF EG times. (Refer to the explanation of <VDF Keyboard Tracking EG Time> on p.50.)

<VDA Keyboard Tracking EG Time Switch & Polarity (AT), (DT), (ST), (RT)>

OFF, ON(+), ON(-)



Specifies the direction of the change in VDA EG Attack Time (AT), Decay Time (DT), Slope Time (ST) and Release Time (RT) that will be produced by VDA keyboard tracking. (Refer to the explanation of <VDF Keyboard Tracking EG Time Switch & Polarity> on p.50.)

VDA LFO

<VDA LFO Waveform>

TRIANGLE, SAW UP, SAW DOWN, SQUARE 1, SQUARE 2, RANDOM



Selects the waveform which will be used for VDA modulation.

<VDA LFO Frequency>

000...127



Specifies the frequency of the VDA modulation waveform.

<VDA LFO Intensity>

-128...000...+127



Specifies the depth (strength) of the VDA modulation effect.

<VDA LFO Delay>

000...127



Specifies the time from note-on until VDA modulation begins to take effect.

<VDA LFO Fade-in Time>

000...127



After the Delay Time has elapsed and modulation begins to take effect, this parameter specifies the time over which the specified Intensity is reached.

VDA EG

<VDA EG Attack Time>

000...127



Specifies the time from note-on until the Attack Level is reached.

This value is added to the value of the Part parameter <EG Attack Time>.

<VDA EG Attack Level>

000...127



Specifies the volume that will be reached after the Attack Time.

<VDA EG Decay Time>

000...127



After the Attack Time has elapsed, this parameter specifies the time until the Break Point is reached.

This value is added to the value of the Part parameter <EG Decay Time>.

<VDA EG Break Point>

000...127

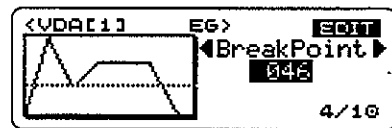

Specifies the volume level that will be reached after the Decay Time.

<VDA EG Slope Time>

000...127



After the Decay Time has elapsed, this parameter specifies the time until the Sustain Level is reached.

<VDA EG Sustain Level>

000...127

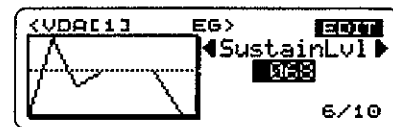

Specifies the volume level after the Slope Time has elapsed.

<VDA EG Release Time>

000...127



Specifies the time from note-off until the volume reaches 0.

This value is added to the value of the Part parameter <EG Release Time>.

<VDA EG Amplitude Velocity Sensitivity>

-128...000...+127

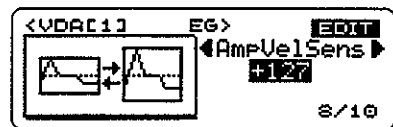

Specifies how velocity will affect the changes produced by the VDA EG.

<VDA EG Time Velocity Sensitivity>

000...127



Specifies how velocity will affect the various VDA EG times.

Refer to the explanation for <VDF EG Time Velocity Sensitivity> on p.52.

<VDA EG Time Velocity Sensitivity Switch & Polarity (AT), (DT), (ST), (RT)>

OFF, ON(+), ON(-)

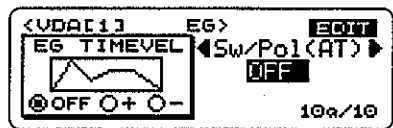

Specifies the direction of the change in VDA EG Attack Time (AT), Decay Time (DT), Slope Time (ST) and Release Time (RT) that will be produced by velocity. Refer to the explanation for <VDF EG Time Velocity Sensitivity Switch & Polarity> on p.52.

Fx

<Oscillator Panpot>

RND, L63...CNT...R63, OFF, ***

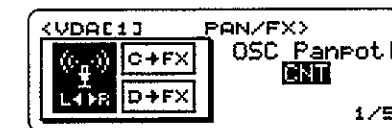

Specifies the output balance of the oscillators. This will be the input to the effect section.

In the case of a drumkit oscillator, the setting for each instrument (note) will be used, and the value of this parameter will be displayed as "***."

<C Send Level/D Send Level>

000...127



Specifies the amount that will be output to C and D. This will be the input to the effect section.

In Multi mode, this parameter is ignored, and the C/D Send Levels of each Part will be used.

In Performance Play/Edit modes, this parameter will be multiplied by the Part parameter C/D Send Level to determine the actual result. In the case of a program selected by a combination, this parameter will be ignored, and the C/D Send Levels of the Timbre and the Part will be multiplied to determine the actual result.

Please be aware that when a GM System On message is received, the Part C (REV) Send will be set to 40, and the D (CHO) Send will be set to 00.

In the case of a drumkit oscillator, the send amount for each instrument (note) will be multiplied by the value of this parameter to determine the actual send levels to C and D.

<Effect Bank>

U, A, B, C, u, a, b, c, G

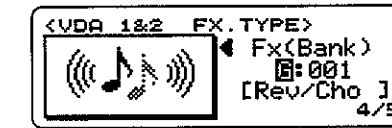

Selects the bank of the effect which the program sound will use (refer to p.30). It is not possible to select "P" for this setting.

From this display, you can press the [EDIT/ENTER] key to enter Effect Edit mode.

<Effect Number>

001...128 (for effect bank G)

000...099 (for effect banks other than the above)

Specifies the number of the effect which the program sound will use.

From this display, you can press the [EDIT/ENTER] key to enter Effect Edit mode.

Control

<Mono/Poly>

MONO, POLY



Specifies whether the program sound will be played monophonically (single notes) or polyphonically (chords). When MONO is selected, only one note will sound even if you press two or more notes.

<Portamento Switch>

ON, OFF



Turns portamento ON or OFF. (Portamento creates a smooth change in pitch between notes.)

When the setting is changed or when a program change occurs, this will be copied to the Part parameter <Portamento Switch>.

Combination sounds will ignore this setting.

<Portamento Time>

000...127

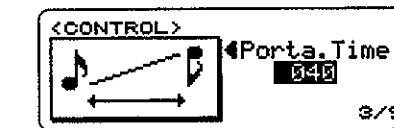

Specifies the portamento time (the time over which the pitch will move to the next note).

The value of this parameter will be added to the value of the Part parameter <Portamento Time>.

<Bend Wheel VDF>

-128...000...+127

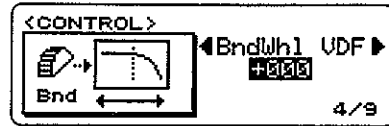

Specifies how the pitch bend wheel will affect the cut-off frequency.

The value of this parameter will be added to the value of the Part parameter <Part VDF Cutoff>.

<Modulation Wheel VDF>

000...127

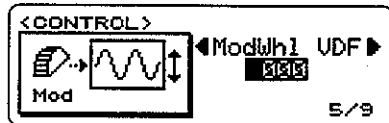

Specifies how control change #1 (the modulation wheel) will affect the VDF cutoff frequency.

<Aftertouch Pitch Bend Range>

-24...00...+24

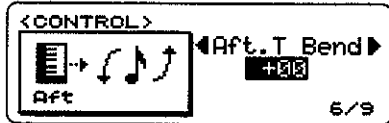

Specifies the range of pitch bend that will be controlled by aftertouch.

The value of this parameter will be added to the value of the Part parameter <Part Pitch Bend Range>.

<Aftertouch VDA>

-128...000...+127



Specifies how aftertouch will affect the VDA volume.

The value of this parameter will be added to the value of the Part parameter <Part VDA Amplifier>.

<Aftertouch VDF>

-128...000...+127



Specifies how aftertouch will affect the VDF cutoff frequency.

The value of this parameter will be added to the value of the Part parameter <Part VDF Cutoff>.

<Aftertouch VDF LFO>

000...127



Specifies how aftertouch will affect the depth of VDF LFO modulation.

The value of this parameter will be added to the value of the Part parameter <Part VDF LFO Depth>.

Rename

<Program Rename>



Here, you can modify the name of the program sound. Use the CURSOR [◀|▶] keys to select the character that you wish to modify, and use the [VALUE] knob or the [INC+]/[DEC-] keys to modify the character.

The following characters and symbols can be used:

!	"	#	\$	%	&	'	()	*	+	,	.	/
0	1	2	3	4	5	6	7	8	9	:	<	=	>
@	A	B	C	D	E	F	G	H	I	J	K	L	M
N	O	P	Q	R	S	T	U	V	W	X	Y	Z	[
\]	^	_	`	a	b	c	d	e	f	g	h	i
j	k	l	m	n	o	p	q	r	s	t	u	v	w
x	y	z	{		}	~	+						

6. Drumkit Edit mode

<Drumsample Select>

000...303



Specifies the drumsample which will be assigned to the currently selected instrument. For details on the available drumsamples, refer to the "Drumsample" at the end of this manual.

<Drumsample Level>

000...127



Specifies the volume of the currently selected instrument.

<Transpose>

-64...00...+63



Transposes the pitch of the currently selected instrument in semitone steps.

The available transposition range will differ slightly depending on the drumsample.

<Fine Tune>

-64...00...+63



Makes fine adjustments to the pitch of the currently selected instrument.

<Panpot>

RND, L63...CNT...R63, OFF



Specifies the panning (the location when heard in stereo) for the currently selected instrument. CNT indicates center. With a setting of RND, the sound will be heard from a different location each time a note is played.

With a setting of OFF, there will be no output from either A or B.

<Assign Mode>

Single, Multi



Specifies how the currently selected instrument will sound if it receives multiple note-on messages in succession.

(A) Single

If an identical note-on message is received when the note is already sounding, the currently-sounding note will be forced off, and a new note will be started.

(B) Multi

If an identical note-on message is received when the note is already sounding, the currently-sounding note will be allowed to continue, and a duplicate note will be started.

<Exclusive Group>

OFF, 001...127



If this parameter is set to a value of 001-127, the currently selected instrument will be prevented from sounding simultaneously with any other note which is set to the same Exclusive Group number. For example since it is physically impossible for a hi-hat cymbal to produce both open and closed sounds simultaneously, you may wish to set open and closed hi-hat sounds to the same Exclusive Group number, so that they will not sound simultaneously.

<Relative C Send Level>

000...127



Specifies the level that is sent from the currently selected instrument to the effect C input. The actual amount that is sent to the effect C input is determined by multiplying the value of this parameter with the Program parameter C Send Level.

<Relative D Send Level>

000...127



Specifies the level that is sent from the currently selected instrument to the effect D input. The actual amount that is sent to the effect D input is determined by multiplying the value of this parameter with the Program parameter D Send Level.

<Relative Cutoff>

-64...00...+63



Adjusts the cutoff frequency (brightness) of the currently selected instrument.

<Relative Color>

-64...00...+63



Adjusts the color (boost at the region of the cutoff frequency) of the currently selected instrument.

For some instruments, adjusting this parameter may not have significant effect.

<Relative Attack Time>

-64...00...+63



Adjusts the attack time of the VDF and VDA (tone and volume) for the currently selected instrument.

<Relative Decay Time>

-64...00...+63



Adjusts the decay time of the VDF and VDA (tone and volume) for the currently selected instrument.

<Receive Note On Switch>

ON, OFF



Specifies whether or not note-on messages will be received for the note number of the currently selected instrument. If this is turned OFF, the corresponding note number will not sound.

<Receive Note Off Switch>

ON, OFF



Specifies whether or not note-off messages will be received for the note number of the currently selected instrument. Turn this parameter OFF for an instrument that you do not want to stop sounding when it receives a note-off message.

7. Effect Edit mode

<Effect Placement>

SERIAL, PARA.1, PARA.2, PARA.3, SERI.S, PARA.S

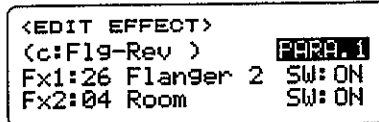

Specifies how the two effects will be connected. For details refer to the diagrams below.

A, B, C, and D parameters are the output from the pan and send settings of Program Play mode <Oscillator Panpot>, <C Send Level / D Send Level>, Combination Edit mode <Timbre Panpot>, <Timbre C Send Level / Timbre D Send Level>, and Multi mode (Performance Play mode) <Panpot>, <C Send Level / D Send Level>.

SERIAL (Serial placement)

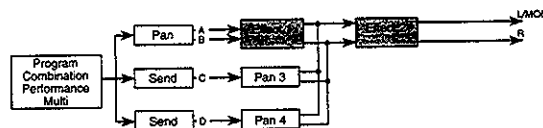

In serial placement, effects 1 and 2 will be applied to the sound that is input to A and B, and output from L/ MONO and R. The sound that is output from C and D will be mixed with the output of effect 1, and will be processed by effect 2 and then output.

By using the C and D inputs, you can avoid applying effect 1 to specific sounds (or conversely apply effect 1 only to specific sounds), and then apply effect 2 to everything.

PARA.1 (Parallel 1 placement)

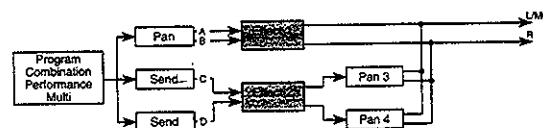

When Parallel 1 is selected, effect 1 will be applied to the sound that is input to A and B. Effect 2 will be applied to the sound that is input to C and D, and this will be mixed with the output of effect 1. Effects 1 and 2 can be used independently.

PARA.2 (Parallel 2 placement)

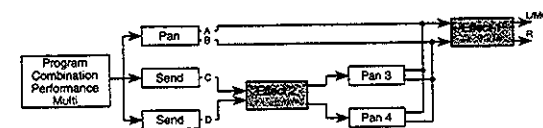

When Parallel 2 is selected, effect 1 will be applied to the sound that is input to A and B, and then will be output. Effect 2 will be applied to the sound that is input to C and D, and the result will be mixed with the input to effect 1.

PARA.3 (Parallel 3 placement)

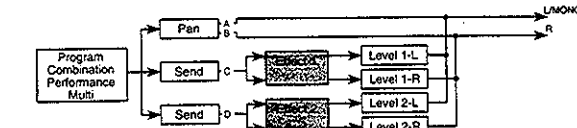

When Parallel 3 is selected, the sound that is input to A and B will be output without further processing. The sound that is input to C and D will be processed by effect 1 and effect 2 respectively, and then pass through an additional assignment before it is mixed into the L/ MONO and R outputs. GM normally uses this placement.

SERI.S (Serial sub placement)

There is no panning for the effect output.

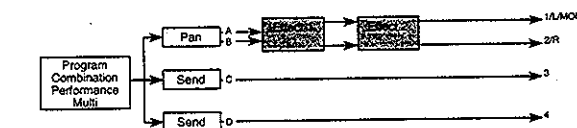

When Serial Sub placement is selected, effects 1 and 2 will be applied to the sound that is input to A and B, and the sound will be output from 1/L/MONO and 2/R. The sound that is input to C and D will be output directly from 3 and 4.

Inputs C and D can be used to send unprocessed sound to external effect units, or to send unprocessed sound to the mixer, etc.

PARA.S (Parallel sub placement)

There is no panning for the effect output.

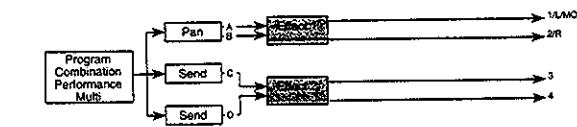

When Parallel Sub placement is selected, effect 1 will be applied to the sound that is input to A and B, effect 2 will be applied to the sound that is input to C and D, and the output of the effects will be sent from 1/L/ MONO, 2/R, 3 and 4 respectively.

Sound will be output from 3 and 4 only when effect placement is Serial Sub or Parallel Sub. Also, the sound which is input to C and D can not be heard in the headphones.

<Effect 1 Type>

01...48

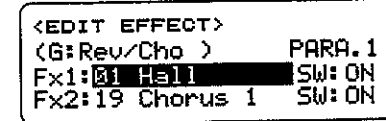

Selects one of the 48 effect types for effect 1. When you change the effect selection, the effect parameters (p.62) will be set to their initial values.

If #24 Symphonic Ensemble is selected as the effect type, there will be some effects which cannot be used simultaneously with this effect.

Reference guide

Effect Edit

<Effect 1 Switch>

ON, OFF

```

<EDIT EFFECT>
(G:Rev/Cho )   PARA.1
Fx1:01 Hall   SW: 01
Fx2:19 Chorus 1 SW: ON

```

Turns effect 1 on/off. If this is OFF, the effect will not apply.

However in the case of the following effects, the EQ Low and EQ High settings of the equalizer will still be valid even if the effect switch is OFF.

#13 Stereo delay, #14 Cross delay,
#19 Chorus 1, #20 Chorus 2, #28 Exciter,
#35 Auto pan, #36 Tremolo

<Effect 2 Type>

01...48

<Effect 2 Switch>

ON, OFF

Selects the effect type that will be used by effect 2.

<Effect 1 Balance>

DRY, 99:01...01:99, EFF

```

<FX.1 CONTROL>   EDIT
(Type:01 Hall )
DRY:FX   MOD.SRC INT
01:20   NONE +00

```

For effect 1, this parameter specifies the proportion of the unprocessed (dry) sound to the processed (effect) sound. A setting of DRY will output only the unprocessed sound, and a setting of EFF will output only the sound processed by the effect.

<Effect 1 Dynamic Modulation Source>

NONE, MOD1, MOD2, MOD3, AFTR.T, VDA-EG

```

<FX.1 CONTROL>   EDIT
(Type:01 Hall )
DRY:FX   MOD.SRC INT
80:20   MOD.1 +00

```

Specifies the control which will apply dynamic modulation to effect 1. "Dynamic modulation" refers to the capability of controlling a specific effect parameter such as modulation speed, depth, or effect level or balance etc. while you play.

The factory settings are as follows.

MOD1: MIDI CC#1, MOD2: MIDI CC#16,
MOD3: MIDI CC#17, AFTR.T: Aftertouch

<Effect 1 Dynamic Modulation Intensity>

-15...00...+15

```

<FX.1 CONTROL>   EDIT
(Type:01 Hall )
DRY:FX   MOD.SRC INT
80:20   MOD.1 +15

```

Specifies the depth of dynamic modulation for effect 1.

In Performance Play/Edit modes, you can assign a control knob to EFFECT D.MOD to control this. (Refer to Performance Edit mode <Control knob#1 Type>.)

When controlling via MIDI, messages received on the MIDI channel of the Upper part in Performance Play mode will control this effect. In Multi mode, messages received on the Global mode <Exclusive Channel> will control this effect.

<Effect 1 Effect Parameters>

Parameters for effect 1

```

<FX1 PARAM>
(Type:01 Hall )
Time : 2.00 H.Dmf:31%
P.Dly:025ms E.Ref:34
EQ.Lo:-01dB EQ.Hi:-03dB

```

The parameters will depend on the selected effect type.

Refer to "Effect types and parameters."

<Effect 2 Balance>**<Effect 2 Dynamic Modulation Source>****<Effect 2 Dynamic Modulation Intensity>****<Effect 2 Effect Parameters>**

(These are the same as for effect 1.)

<Panpot/Output Level>

OFF, L, 99:01...01:99, R (when Effect Placement is SERIAL, PARA.1 or PARA.2)

0...9 (when Effect Placement is PARA.3)

```

<PAN/OUT>
PAN/   PAN 3   PAN 4
LEVEL  50:50   50:50

```

Adjusts the balance and volume for the final output from the effect to the stereo output section. When Effect Placement is SERIAL, PARA.1 or PARA.2, the display will be as shown above, allowing you to adjust the L/R output balance for PAN3 and PAN4.

```

<PAN/OUT>
PAN/   1-L 1-R 2-L 2-R
LEVEL  8   0   8   0

```

When Effect Placement is PARA.3, the display will be as shown above, allowing you to adjust the individual levels.

<Effect Rename>

Here, you can modify the name of the effect program.

For details refer to <Program Rename> on p.35, p.56.

Effect parameter table

[]: Initial Value ●: Dynamic Mod Dest

Table with 4 columns: Effect Name, Parameter 1, Parameter 2, Parameter 3. Rows include REVERB, EARLY REFLECTION, STEREO DELAY, DUAL MONO DELAY, MULTITAP DELAY, CHORUS, HARMONIC CHORUS, SYMPHONIC ENSEMBLE, FLANGER, EXCITER, ENHANCER, DISTORTION, PHASER, ROTARY SPEAKER, TREMOLO, PARAMETRIC EQ, COMBINATION EFFECT SERIAL, COMBINATION EFFECT PARALLEL, and Resonance Filter.

Table with 5 columns: High Damp, EQ Low, EQ High, Dry: FX Balance, and other parameters. Rows include EQ Low, EQ High, Dry: FX Balance, Feedback, Mod Waveform, Mod Depth, Mod Speed, Filter Split Point, Resonance, EQ Low, EQ High, Dry: FX Balance, Delay Time, EQ Low, EQ High, Out Level, Feedback, Mod Waveform, Slow Speed, Fast Speed, Mod Depth, EQ Low, EQ High, Dry: FX Balance, Mid Gain, Mid Width, High Freq, High Gain, Dry: FX Balance, Mod Depth, Delay Time, Feedback, Dry: FX Balance, Reverb Time, Pre Delay, High Damp, Dry: FX Balance, Mod Speed, Mod Depth, Mod Waveform, Dry: FX Balance, Mod Speed, Mod Depth, Feedback, Dry: FX Balance, Acceleration, Slow Speed, Fast Speed, Dry: FX Balance, EG Int, AttackTime, DecayTime, Trigger, LFO Int.

*: Dynamic modulation is used to switch between slow and fast.

Reference guide

Effect Edit

Effect types and parameters

Depending on the effect type that you select, the parameters will differ. For each of the two processors, you can select any effect type from 00 (No Effect) to 48 (Resonance Filter).

NO EFFECT

00: No Effect

For some of the effect types, the equalizer settings (EQ High and EQ Low) will still be valid even if the effect switch is turned off (refer to p.60). If you wish to cut out the equalizer completely, select 00 (No Effect).

REVERB

These effects simulate the acoustics of a hall etc. to add a sense of spatial presence to the sound.

01: Hall

This simulates the reverberation of a medium sized hall, producing a sense of natural acoustics.

02: Ensemble Hall

This reverb is suitable for string or brass ensembles, and simulates the natural acoustics of an ensemble hall.

03: Concert Hall

This simulates the acoustics of a large concert hall, with emphasis on the early reflections.

04: Room

This simulates the acoustics of a smaller room.

05: Large Room

This simulates the acoustics of a larger room, with the reverb density emphasized. When the reverb time is set to approximately 0.5 seconds, an impression similar to gated reverb will be produced.

06: Live Stage

This simulates the reverberation and acoustics of an on-stage live performance in a larger room.

07: Wet Plate

An effect of deeply applied plate reverb.

08: Dry Plate

An effect of lightly applied plate reverb.

09: Spring Reverb

This simulates a resonant spring-type reverb unit.

Parameter	Range
Reverb Time (Time)	0.2...9.9 sec (HALL types) 0.2...4.9 sec (ROOM types) 00...99 (PLATE/SPRING types)
The time over which the reverb will decay	
High Damp (H.Dmp)	0...99%
High frequency attenuation. Higher settings of this parameter will cause the high frequencies to decay more rapidly, making the sound darker.	
Pre Delay (P.Dly)	0...200 ms
The time from the direct sound until the early reflections	
Early Reflection Level (E.R.)	0...99 (HALL/ROOM types) 1...10 (PLATE/SPRING types)
The level of the early reflections	

EQ Low (EQ.Lo) -12...+12 dB
Amount of cut/boost for the LOW EQ

EQ High (EQ.Hi) -12...+12 dB
Amount of cut/boost for the HIGH EQ

For effects 01-09, the dry:effect balance can be controlled by the selected dynamic modulation source.

EARLY REFLECTION

The early reflection effects isolate the initial reflections of the sound (a very important element in determining the overall acoustic character of a space) from the rest of the reverberation. By adjusting the Early Reflection Time you can create a wide range of effects, such as adding richness to the sound, or creating echo-like sounds.

10: Early Reflection 1

This isolates the acoustically important initial reflections of the sound from the rest of the reverberation. Since the low frequency range is emphasized, this effect type is ideal for drums and other percussion.

11: Early Reflection 2

The way in which the early reflections change in level over time differs from Early Reflection 1. Use this according to your taste.

12: Early Reflection 3

Compared with Early Reflection 1 and Early Reflection 2, this effect reverses the envelope of the early reflections. When used on sound which have a strong attack, such as cymbals, it produces a reverse-playback effect.

Parameter	Range
Early Reflection Time (Time)	100...800 ms Duration of the early reflections (10 ms steps)
Pre Delay (P.Dly)	0...200 ms The time from the direct sound until the early reflections
EQ Low (EQ.Lo)	-12...+12 dB Amount of cut/boost for the LOW EQ
EQ High (EQ.Hi)	-12...+12 dB Amount of cut/boost for the HIGH EQ

For effect types 10-12, you can use the selected dynamic modulation source to control the dry:effect balance.

STEREO DELAY

These effect types allow you to set independent delay times for the left and right channels, so that you can create delay patterns which take advantage of stereo. The High Damp setting lets you apply a natural-sounding attenuation to the repeated delays.

13: Stereo Delay

A stereo delay with feedback, that allows independent delay times to be set for the left and right channels.

14: Cross Delay

A stereo delay that allows independent delay times to be set for the left and right channels. For the input to the delay, the feedback of the left and right channels is crossed, so that the repeated delays alternate between left and right.

Parameter	Range
Delay Time Left (D.Time L)	0...500 ms Left channel (A or C input) delay time
Delay Time Right (D.Time R)	0...500 ms Right channel (B or D input) delay time
Feedback (F.Back)	-99...+99% The amount which is fed back into the effect. Negative (-) settings will invert the phase.
High Damp (H.Dmp)	0...99% High frequency attenuation. Increasing this value will cause the high frequencies to decay more rapidly, making the sound darker.
EQ Low (EQ.Lo)	-12...+12 dB Amount of cut/boost for the LOW EQ
EQ High (EQ.Hi)	-12...+12 dB Amount of cut/boost for the HIGH EQ

For effect types 13 and 14, you can use the selected dynamic modulation source to control the dry:effect balance. Even if the Effect Switch is OFF, the equalizer (EQ Low and EQ High) settings will be valid. If you wish to turn off all effects including the equalizer, select 00 (No Effect).

DUAL MONO DELAY

15: Dual Mono Delay

This consists of two mono delays, with independent delay time, feedback and high damp settings.

Parameter	Range
Delay Time Left (D.Time L)	0...500 ms Left channel delay time
High Damp Left (H.DmpL)	0...99% High frequency attenuation of the left channel. Increasing this value will cause the high frequencies to decay more rapidly, making the sound darker.
Feedback Left (F.BackL)	-99...+99% The amount which is fed back into the left channel. Negative (-) settings will invert the phase.
Delay Time Right (D.Time R)	0...500 ms Right channel delay time
High Damp Right (H.DmpR)	0...99% High frequency attenuation of the right channel. Increasing this value will cause the high frequencies to decay more rapidly, making the sound darker.
Feedback Right (F.BackR)	-99...+99% The amount which is fed back into the right channel. Negative (-) settings will invert the phase.

For effect type 15, you can use the selected dynamic modulation source to control the dry:effect balance.

MULTI-TAP DELAY

Each effect input is equalized, and sent to two independent delays. The output of one delay is fed back into the input.

16: Multi-Tap Delay 1

A 2-channel multi-repeat delay.

17: Multi-Tap Delay 2

A 2-channel multi-repeat delay with cross-panning.

18: Multi-Tap Delay 3

A 2 channel multi-repeat delay with feedback alternating between the two delays.

Parameter	Range
Delay Time 1 (D.Time1)	0...500 ms Delay time of delay 1
Delay Time 2 (D.Time2)	0...500 ms Delay time of delay 2
Feedback (FB)	-99...+99% The amount which is fed back into the effect. Negative (-) settings will invert the phase.
EQ Low (EQ.Lo)	-12...+12 dB Amount of cut/boost for the LOW EQ
EQ High (EQ.Hi)	-12...+12 dB Amount of cut/boost for the HIGH EQ

For effect types 16-18, you can use the selected dynamic modulation source to control the dry:effect balance.

CHORUS

These are stereo-type effects with two chorus blocks, and can add natural spaciousness and depth to any type of sound; piano, string, or brass etc.

19: Chorus 1

The modulation of the right channel is out of phase with the modulation of the left channel. This produces a spacious stereo chorus.

20: Chorus 2

The left and right channels are modulated in-phase.

Parameter	Range
Delay Time (Time)	0...200 ms Delay time
Mod Waveform (Wave)	Sine (SIN), Triangle (TRI) Selects the modulation waveform
Mod Depth (Depth)	0...99 Depth of modulation
Mod Speed (Speed)	0.03...30 Hz Speed of modulation
EQ Low (EQ.Lo)	-12...+12 dB Amount of cut/boost for the LOW EQ
EQ High (EQ.Hi)	-12...+12 dB Amount of cut/boost for the HIGH EQ

For effect types 19 and 20, you can use the selected dynamic modulation source to control the dry:effect balance. Even if the Effect Switch is OFF, the equalizer (EQ Low and EQ High) settings will be valid. If you wish to turn off all effects including the equalizer, select 00 (No Effect).

21: Quadrature Chorus

This is a stereo chorus in which the two channels are modulated 90 degrees out of phase with each other.

22: Crossover Chorus

This is a stereo chorus in which the two channels are modulated 90 degrees out of phase with each other, and the chorus portion of each channel is mixed into the output of the other channel.

Parameter	Range
Delay Time Left (Time:L) Left channel delay time	0...250 ms
Delay Time Right (R) Right channel delay time	0...250 ms
Mod Depth (Depth) Depth of modulation	0...99
Mod Speed (Speed) Speed of modulation	1...99
Mod Shape (Shape) Select the modulation waveform. T: triangle wave, S: sine wave. The range from +10 to -10 specifies the symmetry of the waveform.	T+10...T-10, S-10...S+10
EQ Low (EQ.Lo) Amount of cut/boost for the LOW EQ	-12...+12 dB
EQ High (EQ.Hi) Amount of cut/boost for the HIGH EQ	-12...+12 dB

For effect types 21 and 22, you can use the selected dynamic modulation source to control Mod Speed.

23: Harmonic Chorus

This splits the signal into a high-frequency and a low-frequency band. Quadrature Chorus is applied to the high-frequency band, and the low-frequency band is output without modification. This is ideal for low-range instruments such as bass.

Parameter	Range
Delay Time 1 (DT1) Chorus unit 1 delay time	0...500 ms
Delay Time 2 (DT2) Chorus unit 2 delay time	0...500 ms
Mod Depth (Depth) Depth of modulation	0...99
Mod Speed (Speed) Speed of modulation	1...99
Frequency Split Point (SplitPoint) Frequency at which the input signal will be split into high and low frequency bands.	0...18

For effect type 23, you can use the selected dynamic modulation source to control Mod Speed.

SYMPHONIC ENSEMBLE

24: Symphonic Ensemble

This is a multi-stage chorus effect, and is ideal for rich and thick sounds such as strings.

Parameter	Range
Mod Depth (Depth) Depth of modulation	0...99
EQ Low (EQ.Lo) Amount of cut/boost for the LOW EQ	-12...+12 dB
EQ High (EQ.Hi) Amount of cut/boost for the HIGH EQ	-12...+12 dB

For effect type 24, you can use the selected dynamic modulation source to control the dry:effect balance.

 This effect cannot be used simultaneously with the following effects.

19-23:	Chorus
24:	Symphonic Ensemble
25-27:	Flanger
32-33:	Phaser
34:	Rotary Speaker
35-36:	Tremolo
38-39:	Chorus/Flanger - Delay
42:	Delay/Chorus
43:	Delay/Flanger
46:	Delay/Phaser
47:	Delay/Rotary Speaker
48:	Resonance Filter

FLANGER

This effect adds feedback to a chorus effect. When used on sounds with rich overtone content, such as cymbals, it creates a strongly distinctive effect with a pitched feeling added to the modulation.

25: Flanger 1

Same-phase modulation is applied to both channels.

26: Flanger 2

The right and left channels are modulated in opposite phase. This produces a spacious stereo flanging effect.

27: Crossover Flanger

Two flangers with opposite-phase modulation apply feedback to each other.

Parameter	Range
Delay Time (Time) Delay time	0...200 ms
Resonance (Reso) Amount of output signal that will be fed back to the input	-99...+99
Mod Depth (Depth) Depth of modulation	0...99
Mod Speed (Speed) Speed of modulation	1...99
EQ Low (EQ.Lo) Amount of cut/boost for the LOW EQ	-12...+12 dB
EQ High (EQ.Hi) Amount of cut/boost for the HIGH EQ	-12...+12 dB

For effect types 25-27, you can use the selected dynamic modulation source to control Mod Speed.

EXCITER

28: Exciter

This adds sparkle to the sound itself, sharpening the definition of the sound.

Parameter	Range
Blend (Blend) Depth of the exciter effect	-99...+99
Emphatic Point (Emphatic Point) Center frequency at which the exciter effect will be applied	1...10
EQ Low (EQ.Lo) Amount of cut/boost for the LOW EQ	-12...+12 dB
EQ High (EQ.Hi) Amount of cut/boost for the HIGH EQ	-12...+12 dB

For effect type 28, you can use the selected dynamic modulation source to control the dry:effect balance. Even if the Effect Switch is OFF, the equalizer (EQ Low and EQ High) settings will be valid. If you wish to turn off all effects including the equalizer, select 00 (No Effect).

ENHANCER

29: Enhancer

This is a 2-channel enhancer. It contains a delay to give the sound spaciousness. An enhancer raises the clarity of the sound, sharpens its definition and strengthens its presence, bringing the sound to the front of the mix.

Parameter	Range
Harmonic Density (Density) Depth of the enhancer effect	1...99
Hot Spot (H.Spot) Center frequency at which the enhancer effect will be applied	1...20
Stereo Width (S.Width) Width of the stereo image spread by the delay	0...99
Delay Time (D.Time) Delay time	1...99
EQ Low (EQ.Lo) Amount of cut/boost for the LOW EQ	-12...+12 dB
EQ High (EQ.Hi) Amount of cut/boost for the HIGH EQ	-12...+12 dB

For effect type 29, you can use the selected dynamic modulation source to control the dry:effect balance.

DISTORTION

30: Distortion

This effect provides a range of distortion from slight to intense, and even adds a wah effect, making it ideal for solos. The wah effect is adjusted by Hot Spot and Resonance. Hot Spot can be controlled in realtime by dynamic modulation.

31: Overdrive

Applies a smooth overdrive. Like distortion, above, dynamic modulation can be used to control the Hot Spot of the wah filter.

Parameter	Range
Drive (Drive) Amount of distortion/overdrive	1...111
Resonance (Reso) Gain of the resonant wah filter	0...99
Hot Spot (H.Spot) Center frequency of the wah filter	0...99
Out Level (Level) Output level of the distorted sound	0...99
EQ Low (EQ.Lo) Amount of cut/boost for the LOW EQ	-12...+12 dB
EQ High (EQ.Hi) Amount of cut/boost for the HIGH EQ	-12...+12 dB

For effect types 30 and 31, you can use the selected dynamic modulation source to control Hot Spot.

PHASER

These effect types are 2-channel stereo phasers.

While chorus and flanger modulate the delay time to create modulation, a phaser modulates the phase of the input signal, creating an effect with a different character than either chorus or flanger. It is especially effective when used on electric piano or guitar-type sounds.

The optimal effect will be produced when the dry:effect balance is set at 50:50.

32: Stereo Phaser 1

Since the modulation of the right and left channels is in opposite phase, a spacious phaser effect is produced.

33: Stereo Phaser 2

Same-phase modulation is applied to both phaser blocks.

Parameter	Range
Manual (Manual) Center frequency at which the phase shift effect is applied	0...99
Mod Depth (Depth) Depth of the phase shift modulation effect	0...99
Mod Speed (Speed) Modulation speed	0.03...30 Hz
Feedback (F.Back) Amount that is fed back into the effect. Negative (-) settings will invert the phase.	-99...+99
Mod Waveform (Wave) Modulation waveform	Sine (SIN), Triangle (TRI)

For effect types 32 and 33, you can use the selected dynamic modulation source to control Mod Speed.

ROTARY SPEAKER

This effect type simulates the rotary speaker effect which is popular for organ sounds.

34: Rotary Speaker

This effect type uses independent LFOs to simulate the rotational effect of the rotor and horn of a rotary speaker. Use the dynamic modulation source to switch between slow and fast speeds. The speed of rotation will switch (between slow and fast) at the rate specified by Acceleration, regardless of the speed at which the controller was actually moved. Also, the speed change will not be affected by the dynamic modulation intensity setting.

Parameter	Range
Vibrato Depth (Vib.Depth) Depth of the effect	0...15
Acceleration (Accel) Time required for the speed to change	1...15
Slow Speed (Slow Speed) Slow rotation speed	1...99
Fast Speed (Fast Speed) Fast rotation speed	1...99

For effect type 34, you can use the selected dynamic modulation source to switch between Slow Speed and Fast Speed.

TREMOLO

These effect types cyclically modulate the volume.

35: Auto Pan

This is a stereo-type program which combines two tremolo blocks. Since opposite-phase modulation is applied to each tremolo block, the sound will appear to be panned back and forth between left and right.

36: Tremolo

Unlike the above Auto Pan, the two tremolo blocks are modulated with the same phase.

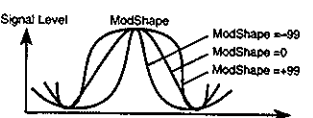
Parameter	Range
Mod Waveform (Wave) Select the modulation waveform	Sine (SIN), Triangle (TRI)
Mod Shape (Shape)	-99...+99
	
Mod Depth (Depth) Depth of modulation	0...99
Mod Speed (Speed) Speed of modulation	0.03...30 Hz
EQ Low (EQ.Lo) Amount of cut/boost for the LOW EQ	-12...+12 dB
EQ High (EQ.Hi) Amount of cut/boost for the HIGH EQ	-12...+12 dB

For effect types 35 and 36, you can use the selected dynamic modulation source to control the dry:effect balance. Even if the Effect Switch is OFF, the equalizer

(EQ Low and EQ High) settings will be valid. If you wish to turn off all effects including the equalizer, select 00 (No Effect).

PARAMETRIC EQ (Parametric Equalizer)**37: Parametric EQ (Parametric Equalizer)**

This is a 3-band equalizer, with adjustable cutoff frequency and gain for each of the bands (low, mid, high). For the mid-range, you can also adjust the width of the frequency band.

Parameter	Range
Low Freq (L=Freq) Low range cutoff frequency	0...29
Low Gain (Gain) Amount of cut/boost for the low EQ	-12...+12 dB
Mid Freq (M=Freq) Mid range center frequency	0...99
Mid Gain (Gain) Amount of cut/boost for the mid EQ	-12...+12 dB
Mid Width (W) Width of the mid-frequency range	0...99
High Freq (H=Freq) High range cutoff frequency	0...29
High Gain (Gain) Amount of cut/boost for the high EQ	-12...+12 dB

For effect type 37, you can use the selected dynamic modulation source to control Mid Freq, allowing you to create a wah effect.

COMBINATION EFFECT SERIAL

Effect types 38 and 39 connect a mono-in/stereo-out chorus or flanger in series with a stereo delay.

38: Chorus-Delay

The signal is sent through a mono-in/stereo-out chorus which uses LFOs that are 90 degrees out of phase, and then through a stereo delay. Feedback can be adjusted for both chorus and delay.

39: Flanger-Delay

The signal is sent through a mono-in/stereo-out flanger which uses LFOs that are 90 degrees out of phase, and then through a stereo delay. Feedback can be adjusted for both flanger and delay.

Chorus, Flanger

Parameter	Range
Delay Time (Cho.DT) Delay time of the chorus/flanger	0...50 ms
Feedback (FB) Amount that is fed back to the effect. Negative (-) settings will invert the phase.	-99...+99%
Mod Depth (Cho. Depth) Depth of modulation	0...99
Mod Speed (Speed) Speed of modulation	1...99

Delay

Parameter	Range
Delay Time (Dly.DT) Delay time (2 msec steps)	0...450 ms
Delay Feedback (FB) Amount that is fed back to the effect. Negative (-) settings will invert the phase.	-99...+99

For effect types 38 and 39, you can use the selected dynamic modulation source to control the dry:effect balance.

COMBINATION EFFECT PARALLEL

The following effect types (40-47) are parallel effects in which two different effects are applied to each of the two channels.

For details on what each effect does, refer to the explanations for effect types 1 to 34.

MONO DELAY/REVERB**40: Delay/Hall Reverb**

This effect type provides delay on the left channel, and hall-type reverb on the right channel.

41: Delay/Room Reverb

This effect type provides delay on the left channel, and room-type reverb on the right channel.

MONO DELAY/MODULATED DELAY**42: Delay/Chorus**

This effect type provides delay on the left channel, and chorus on the right channel.

43: Delay/Flanger

This effect type provides delay on the left channel, and flanger on the right channel.

Parameter	Range
Delay Time (Dly.DT) Delay time	0...500 ms
Feedback (Dly.FB) Amount that is fed back to the effect. Negative (-) settings will invert the phase.	-99...+99%
High Damp (H.Dmp) High frequency attenuation. Increasing this parameter value will cause the high range to decay faster, making the sound darker.	0...99%
Reverb (Hall, Room)	
Reverb Time (Time)	0.2...9.9 sec (Hall) 0.2...4.9 sec (Room)
Time over which the reverberation will decay	
High Damp (H.Dmp) High frequency attenuation. Increasing this parameter value will cause the high range to decay faster, making the sound darker.	0...99%
Pre Delay (P.Dly) Time from the direct sound until the first early reflection.	0...150 ms

Chorus

Parameter	Range
Mod Depth (Depth) Depth of modulation	0...99%
Mod Speed (Spd) Speed of modulation	0.03...30 Hz
Mod Waveform (Wave) Modulation waveform	Sine (SIN), Triangle (TRI)

Flanger

Parameter	Range
Mod Depth (Depth) Depth of modulation	0...99%
Mod Speed (Spd) Speed of modulation	0.03...30 Hz
Feedback (FB) Amount that is fed back to the effect. Negative (-) settings will invert the phase.	-99...+99%

For effect types 40, 41, 42 and 43, you can use the selected dynamic modulation source to control the dry:effect balance.

MONO DELAY/DISTORTION, OVERDRIVE**44: Delay/Distortion**

This effect type provides delay on the left channel, and distortion on the right channel.

45: Delay/Overdrive

This effect type provides delay on the left channel, and overdrive on the right channel.

Parameter	Range
Delay Time (Dly.DT) Delay time	0...500 ms
Feedback (Dly.FB) Amount that is fed back to the effect. Negative (-) settings will invert the phase.	-99...+99%
Distortion, Overdrive	
Drive (Drive) Amount of distortion/overdrive	1...111
Resonance (Res) Gain of the resonant wah filter	0...99
Hot Spot (HotSpot) Center frequency of the wah filter	1...99
Level (Level) Output level of the distorted sound	1...99

MONO DELAY/PHASER**46: Delay/Phaser**

This effect type provides delay on the left channel, and phaser on the right channel.

Delay

Parameter	Range
Delay Time (Dly.DT) Delay time	0...500 ms
Feedback (Dly.FB) Amount that is fed back to the effect. Negative (-) settings will invert the phase.	-99...+99%
High Damp (H.Dmp) High frequency attenuation. Increasing this parameter value will cause the high range to decay faster, making the sound darker.	0...99%

Phaser

Parameter	Range
Mod Depth (Depth) Depth of modulation	0...99%
Mod Speed (Spd) Speed of modulation	0.03...30 Hz
Feedback (FB) Amount that is fed back to the effect. Negative (-) settings will invert the phase.	-99...+99%

For effect type 46, you can use the selected dynamic modulation source to control the dry:effect balance.

MONO DELAY/ROTARY**47: Delay/Rotary Speaker**

This effect type provides delay on the left channel, and a rotary speaker effect on the right channel.

Delay

Parameter	Range
Delay Time (Dly.DT) Delay time	0...500 ms
Feedback (Dly.FB) Amount that is fed back to the effect. Negative (-) settings will invert the phase.	-99...+99%

Rotary Speaker

Parameter	Range
Acceleration (Accel) The time over which the speed will change	1...15
Slow Speed (Slow) Speed of slow rotation	1...99
Fast Speed (Fast) Speed of fast rotation	1...99

For effect type 47, you can use the selected dynamic modulation source to switch between Slow Speed and Fast Speed.

Resonance Filter**48: Resonance Filter**

This effect type boosts the level in the region of the cut-off frequency. This will boost the overtones, creating a hard and distinctive sound.

Parameter	Range
Trim Input level	0...99
LFO Apply LFO to the cutoff frequency. The LFO speed will follow the Program parameter VDF LFO of OSC1.	0...127

Trg **Single/Multi1/Multi2**

Select the trigger type which will determine how the EG responds to note-on.

Single

The EG will be started by the first note-on (the first note which is pressed from a condition of all notes being off). If all notes go off during the attack, the EG will switch to decay.
At the first note-on during the decay, the EG will switch to attack, starting from the EG value at that time.
LFO will correspond to the note which was first turned on. The LFO will stop when that note is turned off.

Multi1

When the first note-on occurs, the EG will switch to attack, starting from the EG value at that time.
If the note which was first turned on goes off during the attack, the EG will switch to the decay.
At the first note-on during the decay, the EG will switch to attack, starting from the EG value at that time.
LFO will correspond to the note which was last turned on. The LFO will stop when that note is turned off.

Multi2

When the first note-on occurs, the EG value will return to 0 (zero), and will then begin the attack.
If the note which was last turned on goes off during the attack, the EG will switch to the decay.
LFO will correspond to the note which was last turned on. The LFO will stop when that note is turned off.

Reso Depth of the resonance effect	0...99
Fc Cutoff frequency. This will be the start level of the EG.	0...99
EGint Depth of the EG effect. Negative (-) settings will invert the EG curve.	-99...0...+99%
AttackTime	0...127
DecayTime	0...127
Resonance has a special EG used only for attack time and decay time, causing the cutoff frequency to sweep when triggered by note-on.	

 The EG will be triggered by a note-on in the Upper part of Performance mode. This EG will not function in Multi mode.

The selected dynamic modulation source will control the Reso parameter.

8. Multi mode**<Receive MIDI channel>**

A01...A16, B01...B16, OFF



Specifies the MIDI receive channel for each part. With a setting of OFF, that part will not receive MIDI messages.

<Key Shift>

-24...00...+24 [Semitone]



For each part, you can specify a key shift (transposition) in semitone steps.

If MIDI RPN 00:02 (Coarse Tune) is received, the pitch that will sound is determined by the sum of the RPN value and this value. (The RPN value will not affect this display.)

<Bank Number>

CmbU, A, B, C, PrgU, A, B, C, GM-b, GM-a, r:01...r:40, r:CM, y:01...y101, ySFX, yDr1, yDr2, rDrm, kDrm, ****

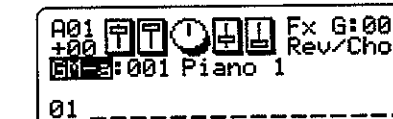

Selects the sound bank for each part. For details refer to the "Bank names and their contents" on p.20.

**** indicates a silent program.

<Program Number>

000...099 (for sound banks PrgA, B, C, U, CmbA, B, C, U)

001...128 (for sound banks other than the above)

Selects the program number for the sound of each part. If a combination sound bank is selected, that part will play a combination sound.

<Volume>

000...127



Adjusts the volume of each part.

<Expression>

000...127



Adjusts the expression (the depth of MIDI control change #11) for each part.

<Panpot>

RND, L63...CNT...R63, OFF



Adjusts the panpot for each part. When CNT is selected, that part will be heard from the center. When RND is selected, the sound will be heard from a different location each time a note is played. When OFF is selected, that Program/Combination will be output only from C and D (refer to p.59).

In Multi mode, the value you specify here will be added to the value of the program/combination parameter to determine the actual panpot setting.

<C Send Level>

000...127



Specifies the amount that is sent from output C of each part to the effects.

In Multi mode, the Program parameter C/D Send Level is ignored. For the C/D Send Levels of Combination parameters and of each instrument in a drumkit, the value will be multiplied by this (Multi mode) parameter to determine the result.

In Performance Play/Edit mode, the Program parameter C/D Send Level will be multiplied by this (Multi mode) parameter to determine the result. (Only for the Upper and Lower parts; other parts will use their Multi mode setting.) For the C/D Send Levels of Combination parameters and of each instrument in a drumkit, the value will be multiplied by this (Multi mode) parameter to determine the result.

<D Send Level>

000...127

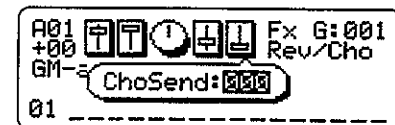

Specifies the amount that is sent from output D of each part to the effects. Refer to <C Send Level>

<Effect Bank Select>

P, U, A, B, C, u, a, b, c, G



Selects the effect bank for the effect used in Multi mode. Refer to p.30.

<Effect Number Select>

001...128 (for effect bank G)

000...099 (for effect banks other than the above)

Selects the number of the effect used in Multi mode.

A number cannot be selected when <Effect Bank Select> is P.

9. Part Edit mode

PART EDIT

<Part Edit>

EG, Scale, Mod, Fc/Win, Others



Selects the section that you wish to edit.

EG <PART-EG>

<EG Attack Time>

-64...00...+63



Adjusts the attack time of the tone and volume of each part.

This value is added to the value of the Program parameter <VDA EG Attack Time>, <VDF EG Attack Time>.

<EG Decay Time>

-64...00...+63

Adjusts the time over which the volume and tone of each part fall from their maximum level to the Sustain Level.

This value is added to the value of the Program parameter <VDA EG Decay Time>, <VDF EG Decay Time>.

<EG Release Time>

-64...00...+63

Adjusts the time from note-off over which the volume and tone of each part fall until the sound disappears.

This value is added to the value of the Program parameter <VDA EG Release Time>, <VDF EG Release Time>.

<Pitch EG Start Level>

-64...00...+63



Adjusts the pitch at which the waveform of each part will begin.

This value is added to the value of the Program parameter <Pitch EG Start Level>.

<Pitch EG Attack Time>

-64...00...+63

Adjusts the rise time of the pitch EG for each part.

This value is added to the value of the Program parameter <Pitch EG Attack Time>.

<Pitch EG Release Time>

-64...00...+63

Adjusts the time from note-off over which the pitch EG of each part reaches the target pitch.

This value is added to the value of the Program parameter <Pitch EG Release Time>.

<Pitch EG Release Level>

-64...00...+63

Adjusts the pitch toward which the pitch EG waveform of each part will move after note-off.

This value is added to the value of the Program parameter <Pitch EG Release Level>.

Scale <PART-SCALE TUNE>

<Scale Tuning>

-64...00...+63 (for each note C-B)

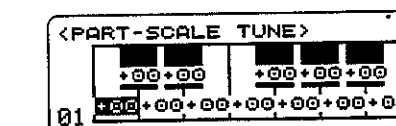

For each part, you can make a fine adjustment to the pitch of each note C-B. Use this when you wish to use special tunings such as the temperaments of classical or ethnic music, or for modern music.

Refer to the table of temperament data on p.95.

Mod <PART: Mod>

The pages in the Mod section specify how the operations of various controllers (or corresponding MIDI messages that are received) will modify each part.

The following controllers and MIDI messages can be used as modulation sources.

	MIDI message	Controller
BNDWHL	Pitch bend	-
MODWHL	Modulation (control change 1)	-
CAf	Channel pressure	-
Mod.2	Assignable Controller 1 (control change 16)	Modulation 2 (realtime controller)
Mod.3	Assignable Controller 2 (control change 17)	Modulation 3 (realtime controller)
PAf	Polyphonic key pressure	-

<Part Pitch Bend Range>

(common to all controllers)

PRG (PRG is bend wheel only), -24...00...+24

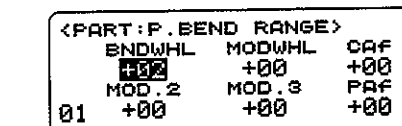

For each part, this parameter specifies the range of the pitch bend that can be produced by the corresponding MIDI message (or by each controller).

In Performance Play mode, this will be PRG when a program change occurs for a part. In Multi mode, a setting of -24→+24 will cause the setting of the Program parameter Bend Range to be ignored. In Performance Play mode, this will change to PRG when a program change is received.

With a setting of PRG, the setting of the Program parameter <Pitch Bend Range> (p.48) will be used.

<Part VDF Cutoff>

(common to all controllers)

-64...00...+63

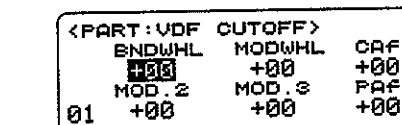

For each part, this parameter specifies how the VDF cutoff frequency will be affected by the corresponding MIDI message (or by each controller).

For CAf, this setting will be added to the value of the Program parameter <Aftertouch VDF>.

<Part VDA Amplifier>

(common to all controllers)
-64...00...+63

<PART:VDA AMP>			
BNDWHL	MODWHL	CAF	
+00	+00	+00	
MOD.2	MOD.3	PAF	
01	+00	+00	+00

For each part, this parameter specifies how the VDA volume will be affected by the corresponding MIDI message (or by each controller).

For CAF, this setting will be added to the value of the Program parameter <Aftertouch VDA>.

<Part LFO Rate>

(common to all controllers)
-64...00...+63

<PART:LFO RATE>			
BNDWHL	MODWHL	CAF	
+00	+00	+00	
MOD.2	MOD.3	PAF	
01	+00	+00	+00

For each part, this parameter specifies how the LFO frequency will be affected by the corresponding MIDI message (or by each controller).

For MODWHL, this setting will be added to the value of the Program parameter <Modulation Wheel Pitch LFO Speed>.

For CAF, this setting will be added to the value of the Program parameter <Aftertouch Pitch LFO Speed>.

<Part Pitch LFO Depth>

(common to all controllers)
000...127

<PART:Pitch LFO>			
BNDWHL	MODWHL	CAF	
000	010	000	
MOD.2	MOD.3	PAF	
01	000	000	000

For each part, this parameter specifies how the pitch LFO depth will be affected by the corresponding MIDI message (or by each controller).

For CAF, this setting will be added to the value of the Program parameter <Aftertouch Pitch LFO Intensity>.

For MODWHL, this setting will be added to the value of the Program parameter <Modulation Wheel Pitch LFO Intensity>.

When a GM System ON message is received, MOD-WHL will be set to 10.

<Part VDF LFO Depth>

(common to all controllers)
000...127

<PART:VDF LFO>			
BNDWHL	MODWHL	CAF	
000	000	000	
MOD.2	MOD.3	PAF	
01	000	000	000

For each part, this parameter specifies how the VDF LFO depth will be affected by the corresponding MIDI message (or by each controller).

For MODWHL, this setting will be added to the value of the Program parameter <Modulation Wheel VDF>.

For CAF, this setting will be added to the value of the Program parameter <Aftertouch VDF LFO>.

<Part VDA LFO Depth>

(common to all controllers)
000...127

<PART:VDA LFO>			
BNDWHL	MODWHL	CAF	
000	000	000	
MOD.2	MOD.3	PAF	
01	000	000	000

For each part, this parameter specifies how the VDA LFO depth will be affected by the corresponding MIDI message (or by each controller).

Fc/Win <PART-FILT/WIN>**<Cutoff Frequency>**

-64...00...+63

<PART-FILT/WIN>	
Cutoff Freq	= +16 ▶
01	

Adjusts the cutoff frequency (brightness) of each part.

<Color>

-64...00...+63

<PART-FILT/WIN>	
Color	= +00 ▶
01	

Adjusts the color (tonal character) of each part.

<Note Window Bottom>

C-1...G9

<PART-FILT/WIN>	
NoteWin Bottom	= C-1 ▶
01	

Specifies the lower limit of the notes for which each part will sound.

<Note Window Top>

C-1...G9

Specifies the upper limit of the notes for which each part will sound.

<Velocity Window Bottom>

001...127

<PART-FILT/WIN>	
Velowin Bottom	= 001 ▶
01	

Specifies the lower limit of velocity for which each part will sound.

<Velocity Window Top>

001...127

Specifies the upper limit of velocity for which each part will sound.

Others <PART-OTHERS>**<Part Mode>**

NORM, DRUM, MDrm1...4

<PART-OTHERS>	
Part Mode	= NORM ▶
01	

For each part, this parameter specifies whether it will use a normal sound (i.e., not a drumkit oscillator) or a drumkit sound.

Modify Drum (MDrm1-4) lets you use MIDI messages (NRPN and Part parameter changes) to control the sound of each note. If an identically-numbered MDrm is selected for another part, it will have the same sound.

▲ Sounds that you edit for Modify Drum are temporary. When you re-select a drumkit, they will return to their initial values.

<Mono/Poly>

MONO, POLY, ---

(displayed as --- if Part Mode is other than NORMAL)

<PART-OTHERS>	
MONO/POLY	= POLY ▶
01	

For each part, this parameter specifies whether it will sound only single notes (mono) or will be able to sound chords (poly). This setting has no effect if <Part Mode> = "DRUM" or "MDrm 1...4."

If the Program parameter setting is "MONO", the POLY setting will be unavailable.

<Fine Tune>

-50...00...+50

<PART-OTHERS>	
FineTune	= +00 ▶
01	

Makes a fine adjustment to the pitch of each part.

<Portamento Switch>

ON, OFF, ---

(displayed as --- if Part Mode is DRUM)

<PART-OTHERS>	
Portament Sw	= OFF ▶
01	

For each part, this parameter turns the portamento effect (which connects notes smoothly from one pitch to the next) on/off. This setting has no effect if <Part Mode> = "DRUM" or "MDrm 1...4."

This setting will be reflected by panel operations.

<Portamento Time>



When the portamento switch is on, this parameter specifies the time over which the pitch will change.

The actual portamento time will be determined by adding this value to the Program parameter.

<Velocity Sensitivity Depth>

000...127



For each part, this parameter specifies how volume will be affected by MIDI velocity data.

<Velocity Sensitivity Offset>

000...127



For each part, this parameter specifies a value that will be added to the entire curve of volume change that is controlled by MIDI velocity data.

10. Global mode

GLOBAL-MASTER

<Master Tune>

-100.0...000.0...+100.0 [cent]



Adjusts the overall tuning of the N1R. You can use this setting to tune the N1R to other instruments.

<Master Key Shift>

-24...00...+24 [semitone]

Transposes the overall pitch of the N1R in semitone steps.

HARDWARE

<LCD Contrast>

00...31

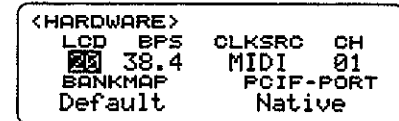

Adjusts the contrast of the N1R's LCD screen. Higher settings will make the display darker.

<BPS Select>

31.25, 38.4

This specifies the rate at which data will be transmitted from the N1R's TO HOST connector to the computer. For the appropriate selection for your computer, refer to p.7 "Connection to a computer."

<Clock Source>

INT, MIDI, PCIF

When the N1R's is synchronized with an external computer/sequencer, this setting specifies which tempo will control the playback. With a setting of INT (Internal), the external computer/sequencer will synchronize to the speed of the N1R's arpeggiator. If you want to synchronize the N1R's arpeggiator to the clock messages received from an external sequencer etc. connected to the MIDI IN connector, set this to MIDI. If you want to synchronize the N1R's arpeggiator to the clock messages received from an external computer connected to the TO HOST connector, set this to PCIF. If you want to match the beat of the external sequencer and the N1R's arpeggiator, set the Performance Play mode <Latch/Key Sync> parameter to "OFF" or "LATCH".

<Exclusive Channel>

01...16

Specifies the MIDI channel on which the N1R will transmit and receive MIDI system exclusive messages etc. to/from an external MIDI device connected to the N1R (refer to p.86).

<Bank Map Type>

Default, 05R/W

Switches the sound map of the N1R. You can specify the bank map used on some Korg products such as the 05R/W. This setting differs from the Default (factory setting) as follows.

Bank select MSB:LSB	Default	05R/W
00H:00H	GM-a	PrgU
78H:00H	rDrm or yDrm	KDrm

<PC Interface To Port>

Native, Emulate

This setting specifies how the tone generator will be switched when a MIDI Line Control signal (F5.vv) is received from the TO HOST connector. With a setting of Emulate, operation will be the same as on Korg's earlier models (05R/W etc.). With a setting of Native, the <MIDI Channel To Port> settings will be applied. Signal flow will be as follows.

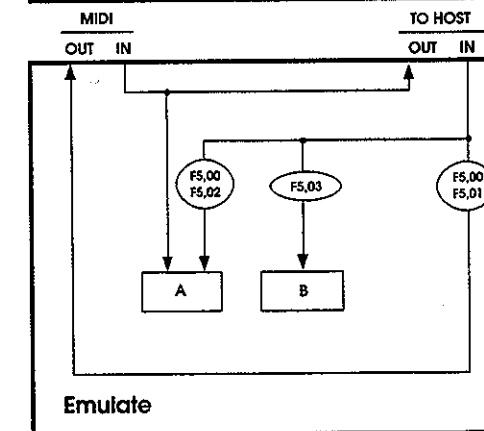
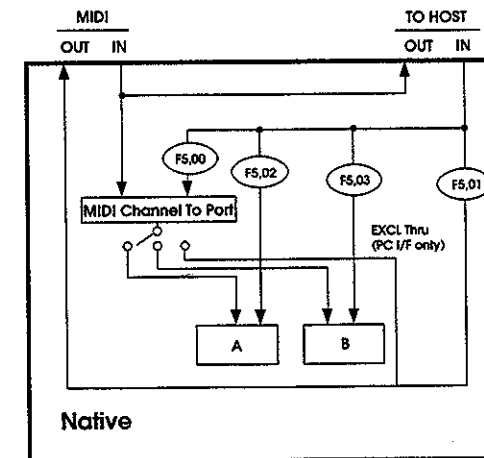

GLOBAL-CONTROL

<Single-channel Layer/Split>

OFF, ON

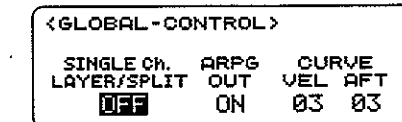

This automatically divides the single MIDI channel (Upper part) received from MIDI IN or TO HOST into two MIDI channels (Upper part and Lower part).

When this is ON, and the Single-channel Layer/Split function is turned on by pressing the [LAYER/SPLIT] key, incoming MIDI messages such as note-on which are received on the MIDI channel of the Upper part will play the sound of the two parts (Upper and Lower) either as a layer or a split.

In this case, the two MIDI channels of the Upper part and Lower part will be output from the TO HOST connector.

This function is valid only when messages are received on the MIDI channel of the Upper part in Performance Play/Edit modes.

<Arpeggio Out>

OFF, ON

With a setting of OFF, note data generated by the arpeggiator will not be transmitted from the N1R's MIDI OUT jack or TO HOST connector.

<Velocity Curve>

01...08

Selects one of eight curves to determine how changes in keyboard playing dynamics will affect volume or tone. The diagram below shows the relationship between playing strength and the resulting velocity value.

Since curves 7 and 8 produce little change for medium playing strengths, they are suitable for when you do not wish to use velocity or when you wish to even out the dynamics of the notes; however in the softly played range, these curves will produce large changes, making control more difficult. Choose the velocity curve that is appropriate for your situation.

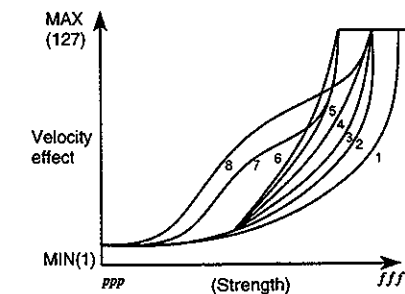

<Aftertouch Curve>

01...08

Selects one of eight curves to determine how additional pressure applied to the keyboard after playing a note will affect volume, tone or modulation.

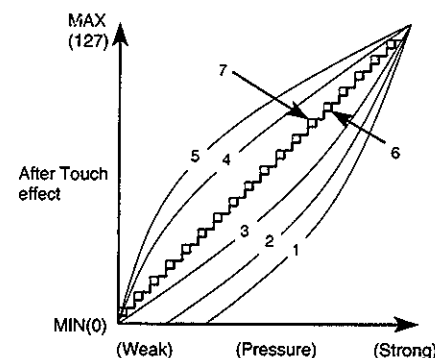

- 1: A significant effect will not be produced unless you apply strong pressure
- 2: :
- 3: The normal curve
- 4: :
- 5: A significant effect will be produced even by light pressure
- 6: Rough curve (24 steps)
- 7: Even rougher curve (12 steps)
- 8: Random

MIDI FILTER

<MIDI Filter>

o (received, transmitted), x (not received, transmitted)

```

<MIDI FILTER>
PRG AFT CTRL EXCL
[ ] [ ] [ ] [ ]
<PROTECT>
Pr9 [ ] Cmb [ ] Drm [ ] Eff [ ]
    
```

If you wish to restrict the MIDI messages that will be received and transmitted by the N1R, make settings here. You can disable reception and transmission of program changes (PRG), aftertouch (AFT), control change (CTRL), and exclusive messages (EXCL).

<Write Protect>

,

```

<MIDI FILTER>
PRG AFT CTRL EXCL
[ ] [ ] [ ] [ ]
<PROTECT>
Pr9 [ ] Cmb [ ] Drm [ ] Eff [ ]
    
```

You can protect the user area of the N1R so that important data cannot be overwritten accidentally. When the box located at the right of Program, Combination, Drumkit and Effect is checked ✓, the corresponding type of memory is protected.

RX. SWITCH

<Receive Switch>

ON, OFF

```

<RX SWITCH>
Rx SW: GMOn GSO n XGOn
        ON  ON  ON
COLOR: GM  GS  XG
        ORG ORG GRN
    
```

Specifies whether the GM, GS and XG initialization messages will each be received or not.

<Receive Color>

GRN (yellow/green), ORG (orange)

When a GM, GS or XG initialization message is received, the backlight of the LCD screen will be switched. The receive color specified for GM will be the color of the LCD screen backlight when the power is turned on.

MIDI TO PORT

<MIDI Channel To Port>

A, B (internal), C (external)

```

<MIDI TO PORT>
MIDI Ch. 1 2 3 4 5 6 7 8
Port     A A A A A A A A
MIDI Ch. 9 10 11 12 13 14 15 16
Port     A A A A A A A A
    
```

For each channel, this parameter specifies whether messages received from an external MIDI device connected to the N1R's MIDI IN will be sounded by the N1R's tone generator or will be transmitted from MIDI OUT. If you connect another tone generator to MIDI OUT, you can cause different channels of MIDI message to be played either by the N1R or by the other tone generator.

⚡ This function is enabled only when the <PC Interface To Port> is set to Native.

PROG TO PORT

<Program Change To Port>

A, B (internal), C (external), Ignore

```

<PROG TO PORT>
Pr9: 001 Ignore
[Piano]
Set All Ignore
    
```

Specifies whether each MIDI program change message received by the N1R will cause internal sounds or external sounds to be played. For example, you can make settings so that piano (#001) will be sounded by the N1R and strings (#049) will be sounded by an external tone generator connected to MIDI OUT.

With a setting of Ignore, this function will be disabled. If you wish to set all numbers 001-128 to the same destination, move the cursor to the Set All parameter, and press the [EDIT/ENTER] key.

⚡ This function is enabled only when the <PC Interface To Port> is set to Native.

PRESET/INIT

<Initialize>

GM Mode On, N-Reset(R), N-Reset(Y), ALL Perform, ALL Program, ALL Combi, User Effect(u), User Effect(U), ALL Drumkit, Factory Preset

```

<PRESET/INIT>
Init: Factory Preset
PRESS [EDIT/ENTER]
    
```

Initializes the state of the N1R. The contents are following.

VALUE	Explanation
GM Mode On	Set to the same condition as when a GM System On message is received.
N-Reset (R)	Set to the same condition as when a GS Reset message is received.
N-Reset (Y)	Set to the same condition as when an XG System On message is received.
ALL Perform	Initialize the settings of the 32 performances
ALL Program	Initialize the settings of the 100 programs of the PrgU bank
ALL Combi	Initialize the settings of the 100 combinations of the CmbU bank
User Effect (u)	Initialize the 100 effects of effect bank "u"
User Effect (U)	Initialize the 100 effects of effect bank "U"
ALL Drumkit	Initialize the two user drumkits
Factory Preset	Restore all settings of the N1R to the factory condition

MIDI DUMP

<MIDI Data Dump>

(Item:) ALL Prog, ALL Combi, ALL Perform, ALL Drumkit, ALL Effect
(to:) PC I/F, MIDI OUT

```

<MIDI DUMP>
Item: ALL Program
to: PC I/F
PRESS [EDIT/ENTER]
    
```

This operation transmits N1R sound parameters to a connected computer or to another N1R. Select the parameters to be transmitted in "Item:" and select either the PC I/F or MIDI OUT from which the data will be transmitted. If you select PC I/F, the data will be transmitted from the TO HOST connector.

Data dump transmission procedure

- ① Connect the N1R's MIDI OUT or TO HOST to an external device which is able to receive MIDI data dumps. Normally it is not necessary to set the MIDI channel of a data filer to match the transmitting channel. If you wish to transmit the data to another N1R to rewrite its programs and patterns, you will need to set the <Exclusive Channel> of both devices to the same setting.
 - ② In "Item," select the type of parameters that you wish to transmit. In "to," select either PC I/F or MIDI OUT to specify the connector from which the data will be transmitted.
 - ③ Press the [EDIT/ENTER] key, and a confirmation message of <Are you sure?> will appear. If you decide to change the settings, press the [EXIT] key.
 - ④ Press the [EDIT/ENTER] key once again to execute the dump.
- While the data is being transmitted, the display will indicate <Executing...>. When transmission is completed, the normal display will reappear.

⚡ Do not touch the switches or controls of the N1R while a data dump is in progress.

⚡ The program sound, combination sound, or performance that is currently being edited is not transmitted here. If necessary, save this data before performing the data dump.

Data dump reception procedure

⚡ When you perform this procedure, internal data will be overwritten and lost. If internal memory contains data that you wish to keep, backup the data to a data filer etc. before performing this procedure.

- ① Connect the N1R's MIDI IN or TO HOST connector to an external device which is able to transmit data dumps.
- ② Turn off memory protect <Write Protect> for program sounds or combination sounds.
- ③ Set <MIDI Filter> EXCL to the O setting.
- ④ Set the N1R's <Exclusive Channel> to match the channel of the transmitting device (if transmitting data that was saved on a data filer, this will be the <Exclusive Channel> at the time that the data was saved), and transmit the data from the external device.

Appendices

Korg MIDI Driver

Installation and setup

Installing the Korg MIDI Driver for Windows 95

- 1 Click the [Start] button in the taskbar, and in [Settings], click [Control Panel].

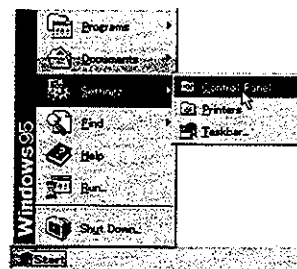

- 2 In the control panel, double-click the [Hardware] icon to start up the hardware wizard, and then click [Next>].
- 3 In response to the question "Automatically detect new hardware?" be sure to reply "No," and then click the [Next>] button.

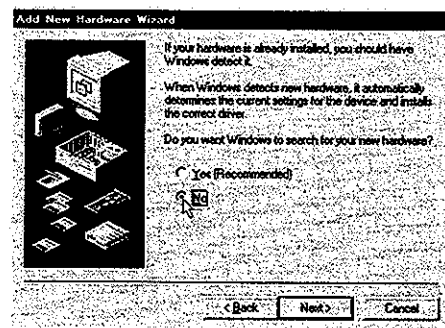

- 4 Select [Sound, video and game controllers], and click the [Next>] button.

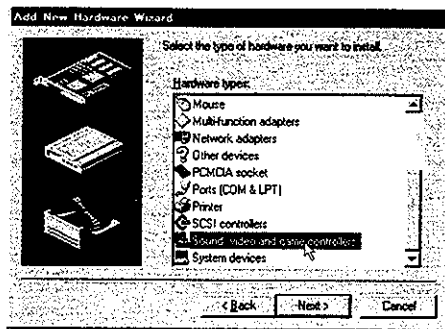

- 5 Click [Have Disk].

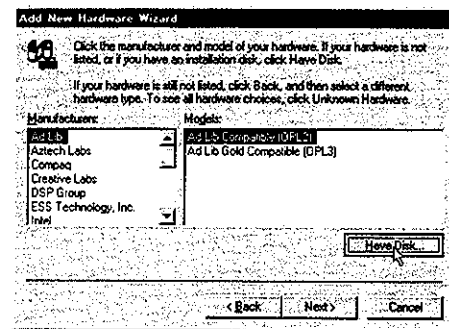

A dialog box will appear, allowing you to specify the drive and directory.

- 6 Insert the disk included with the AG-001B into the disk drive of the computer. If the disk was inserted into drive A, type "A:\\" (or if drive B, type "B:\\") and click the [OK] button.
- 7 Click the [OK] button and click [OK].

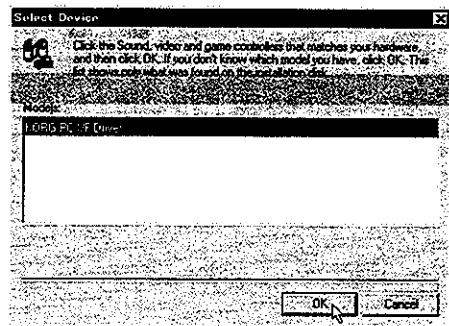

- 8 Perform the setup as directed in "Setting up the Korg MIDI Driver (Windows)," and click the [OK] button.

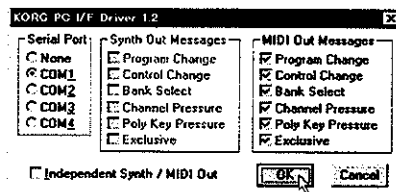

- 9 Be sure to restart your computer so that the driver will take effect.



Modifying the Korg MIDI Driver setup for Windows 95

- 1 In the control panel, double-click the [Multimedia] icon, and the multimedia properties dialog box will appear.

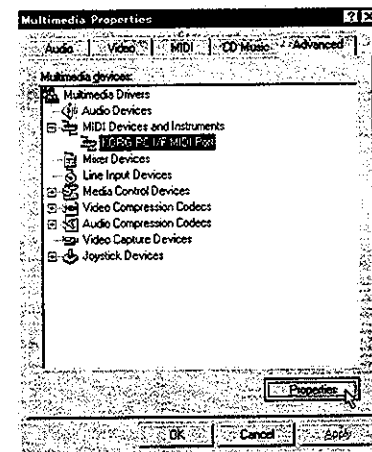

- 2 Click the [Advanced] tab located at the upper right.
- 3 Click the [+] for [MIDI Devices] (the display will change to [-]), and click [KORG PC I/F MIDI Port].
- 4 Click the [Properties] button.

The KORG PC I/F MIDI Port properties will be displayed.

- 5 Click the [Settings] button.

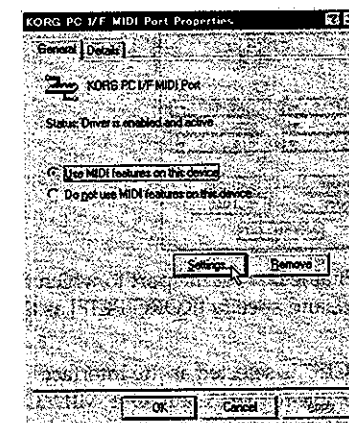

Perform the setup as directed in "Setting up the Korg MIDI Driver (Windows)," and click the [OK] button.

If you have modified the settings, you must re-start Windows.

Setting up the Korg MIDI Driver (Windows)

- 1 For the Serial Port setting, select the serial port to which the N1R is connected ((COM1)–[COM4]).

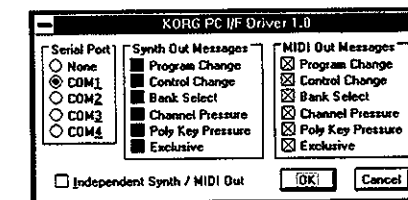

If you wish to use the serial port for another purpose after installing the Korg MIDI Driver, select [None] to disable the driver.

- 2 Check [Independent Synth/MIDI Out].

When this is checked, the two internal ports of the N1R (port A and port B) can be used independently. For data which is output to Default MIDI, operation will depend on the Global mode <PC Interface To Port> setting of the N1R.

If Default Out is selected, and if the N1R is set to Emulate mode, data will be output to both N1R ports A and C. If Native mode is selected, data will be output to the port that is specified by the Global parameter MIDI Channel To Port.

Regardless of whether the N1R is operating in Native mode or Emulate mode, MIDI Out will output from port C, Synth-A Out will output from port A, and Synth-B Out will output from port B.

If [Independent Synth/MIDI Out] is not checked, only Default MIDI can be used.

- 3 [MIDI Out Messages] allows you to select the types of message that will be transmitted to the N1R.
- 4 When you finish making settings, click the [OK] button. If you wish to cancel your settings, click [Cancel].

Installing the Korg MIDI Driver for Windows 3.1

- 1 In the control panel, double-click the Driver icon.

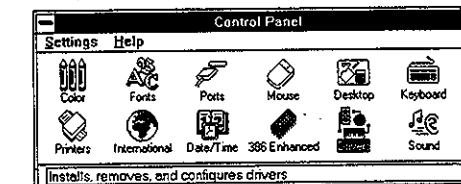

- 2 Click the [Add] button.

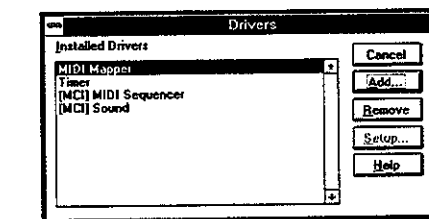

- 3 In the driver list, select [Unlisted or updated driver] and click the [OK] button.

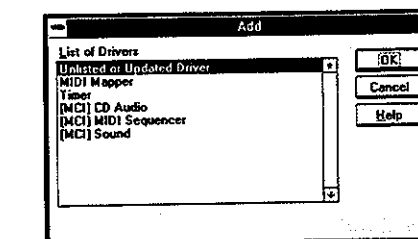

- Insert the disk included with the AG-001B into the disk drive of the computer. If you inserted the disk into drive A, type "A:\\" (for drive B, type "B:\\"), and click the [OK] button.

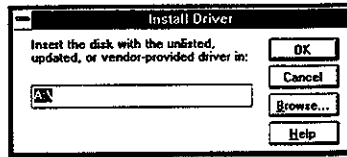

- Select Korg PCI/F Driver, and click the [OK] button. The setup window will appear. Follow the directions in "Setting up the Korg MIDI Driver (Windows)" (refer to p.83) to perform the setup.

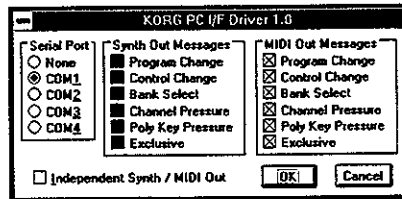

- After setup is complete, remove the disk and select [Restart] to make the newly installed driver available.

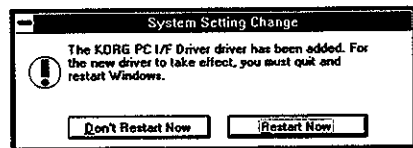

Installing the Korg MIDI Driver for a Macintosh

- In order to use the Korg MIDI Driver, the Apple MIDI Manager and PatchBay must already be installed. Use the versions of Apple MIDI Manager and PatchBay that are included with your MIDI application. They are not included with the AG-002B.

When the Korg MIDI Driver and Apple MIDI Manager are used together, you will be able to playback 32 parts on the N1R.

If you are using a MIDI application (sequencer) which does not use the Apple MIDI Manager, select the port to which the N1R is connected, and if the application has a Clock setting, set it to [1 MHz].

- Copy the Korg MIDI Driver from the disk included with the AG-002B into the system folder of your startup disk.

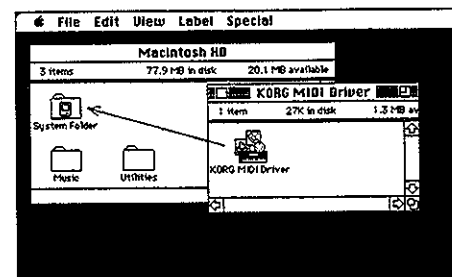

- If there is a copy of Apple MIDI Driver in your system folder, either delete it, or move it to another folder. Be careful not to delete or move the Apple MIDI Manager.

- The Korg MIDI Driver includes the functionality of the Apple MIDI Driver.

- From the Special menu, select "Restart."

Setting up the Korg MIDI Driver (Macintosh)

- Start up PatchBay.

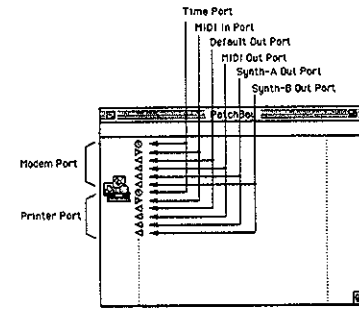

If installation has been performed correctly, the KORG MIDI Driver icon shown above will appear in the PatchBay window when PatchBay is started up. (The modem and printer ports will be displayed differently depending on the setup condition.)

- In PatchBay, double-click the KORG MIDI Driver icon.

The setup dialog box will appear.

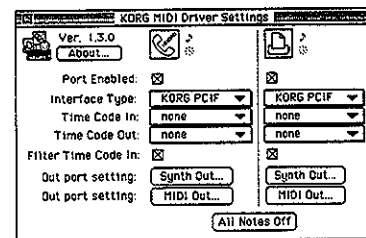

- Check the Port Enable box for the port to which the N1R is connected, and specify [KORG PCIF] as the Interface Type.

When "KORG PCIF" is selected as the Interface Type, you will be able to use Default Out, MIDI Out, Synth-A Out, and Synth-B Out.

The operation of Default Out will depend on the Global mode Program Port setting of the N1R.

If Default Out is selected, and if the N1R is set to Emulate mode, data will be output to both ports A and C of the N1R. If it is set to Native mode, data will be output to the port specified by the Global mode parameter <Bank Map Type>.

Regardless of whether the N1R is in Native mode or Emulate mode, MIDI Out will output to port C, Synth-A Out will output to port A, and Synth-B Out will output to port B.

(Please read p.78 as well.)

- Press the [Out Port Setting] button.

The following dialog box will appear. Here you can select the MIDI channels/messages which will be output to each port. Only those channels/messages whose box is checked will be output.

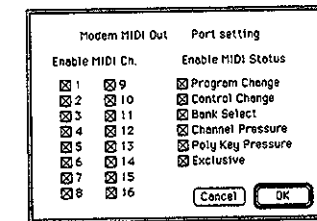

- When you have finished making settings, click the [OK] button.

- Start up your MIDI application (sequencer), and drag the mouse from the "<" of the your MIDI application's Out Port to connect it to the MIDI Out of the MIDI Driver.

- For details on using PatchBay, refer to "About PatchBay..." etc. in the Apple menu.

Using PC Exchange to convert SMF data

Most commercially available Standard MIDI File (SMF) song data is saved in MS-DOS format.

You can use PC Exchange to make MS-DOS format SMF song files recognizable by the Macintosh.

- In the control panel, open PC Exchange.

The PC Exchange control panel will appear.

- Press the [Add...] button.

The [Specify application associated with DOS extension] window will appear.

- Input ".MID" into the DOS extension field.

In order to distinguish different types of file, MS-DOS adds an extension consisting of a period and three characters to the end of the filename. It is customary for SMF data to have an extension of ".MID"

- From the list that appears in the lower part of the dialog box, select your SMF-compatible MIDI application (sequencer).

The selected icon will appear in the Application field.

- From the [Document type] popup menu, choose [Midi], and click the [OK] button.

The item which was added to the PC Exchange window will appear, and has now been registered.

Now when an MS-DOS SMF disk is inserted into the disk drive, it can be used immediately.

For details refer to the documentation for "Macintosh PC Exchange."

About the MIDI File Translator included with the AG-002B

If the Macintosh you are using does not have PC Exchange but does have Apple File Exchange, you can use the MIDI File Translator included with the AG-002B to convert MS-DOS SMF data.

- Put the MIDI File Translator into the same folder as Apple File Exchange.



- Double-click Apple File Exchange to start it up.

- Insert the MS-DOS disk that you wish to convert into the disk drive.

Be sure to insert the MS-DOS format disk into the disk drive only after Apple File Exchange has already started up.

- Select the song file that you wish to convert.

- Press the "<<Convert<<" (or ">>Convert>>") button located in the center.

Conversion will begin. When the bar graph reaches 100%, conversion is complete. The converted file will appear in the left-hand box.

- Exit Apple File Exchange.

Control using MIDI

MIDI channels

Similarly to the way in which a television set operates, the data of a channel can be received when the receiving device is set to the same channel as the transmitting device. The receive channel of each N1R part is set by the Multi mode <Receive MIDI channel> parameter.

About MIDI channels

As in the case of a television, data is received when the channel of the receiving device is set to match the channel of the transmitted device. The receive channel of each of the N1R's Parts is set by the Multi mode <Receive MIDI Channel> setting.

• MIDI receive channel

In **Performance Play mode** when the Single-channel Layer/Split function is on, modulation wheel (control change #01), pitch bend, and aftertouch messages received on the MIDI channel of the Upper part will affect both the Upper and Lower parts. Other control messages will apply only to the part which is set to the MIDI channel on which the message was received.

Effect dynamic modulation is received on the MIDI channel of the Upper part.

The arpeggiator will operate when it receives note-on messages on the MIDI channel for the part specified by the <Arpeggio Zone> setting (p.42). However, when the Single-channel Layer/Split function is on, the arpeggiator will be controlled by the MIDI channel of the Upper part even if the Arpeggio Zone is set to LOWER. (The arpeggiator will also be controlled by the MIDI channel of the Lower part.)

In **Multi mode**, the Single-channel Layer/Split function cannot be used. The various control change messages will affect only the parts which are receiving the MIDI channels on which the messages were transmitted.

Effect dynamic modulation will be received on the <Exclusive Channel> specified in Global mode.

The arpeggiator will operate when note-on messages are received on the MIDI channel for the part which was specified by the <Arpeggio Zone> setting.

• MIDI transmit channel

In **Performance Play mode**, operating the control knobs will transmit messages on the MIDI channel of the Upper part when the cursor is located at the Upper part, or on the MIDI channel of the Lower part when the cursor is located at the Lower part. (This is not affected by the Single-channel Layer/Split setting.) The arpeggio output will be transmitted on the MIDI channel of the part that is playing.

In **Multi mode**, operating the control knobs will transmit messages on the MIDI channel of the currently selected part. The arpeggio output will be transmitted on the MIDI channel of the part that is playing.

- The transmit/receive channel for the N1R's various system exclusive messages is specified by the Global

mode <Exclusive Channel> setting.

- The transmit/receive channel for the various exclusive messages used by the N1R is set by the Global mode parameter <Exclusive Channel>.

Note on/off

When you press a note on a connected MIDI keyboard, data indicating the keyboard location that you pressed (the note number) and the force (velocity) with which you pressed the key will be transmitted as a **Note On** message [9n, kk, vv] (n: channel, kk: note number, vv: velocity). When you release the note, a **Note Off** message [8n, kk, vv] will be transmitted. However, very few instruments transmit or receive Note Off velocity, nor does the N1R receive it.

Changing the sound (program/combination)

A sound (program/combination) can be selected using a **Program Change** message [Cn, pp] (pp: a program number that specifies one of 128 programs).

Bank Select messages [Bn, 00, mm] (control change #00) and [Bn, 20, bb] (control change #32) (mm: bank number MSB, bb: bank number LSB, together selecting one of 16384 possible banks) can be used in conjunction with Program Change messages to select programs from other banks. When a Bank Select message is received on the corresponding MIDI channel for a part, the sound (program/combination) bank will be selected. However the actual sound (program/combination) or bank will not change until a Program Change message is subsequently received.

Changing the performance

To change the performance (01-32) from a computer/sequencer, you can use **Bank Select** [Bn, 00, 5F] (control change #00) and **Program Change** [Cn, pp] (pp:00-1F, performances 01-32) messages. However, the LSB will be ignored. Also, these messages are received only on the <Exclusive Channel> MIDI channel. These messages are received only in Performance Play mode and Multi mode.

Example of transmission (when EXCL ch.=01):
B0, 00, 5F : Bank MSB = 5F (hex) = 95
C0, 01 : change to performance 02

Sustain pedal

When a sustain pedal connected to your MIDI keyboard is operated, a **Hold** message [Bn, 40, vv] (control change #64) (vv is 127 [7FH] for ON, or 00 for OFF) will normally be transmitted.

When this message is received, the sustain pedal effect will be switched off if the value is 63 [3FH] or less, or on if the value is 64 [40H] or greater.

Applying aftertouch

On many types of MIDI keyboard, pressing down on the keyboard after playing a note will cause **Channel Aftertouch** messages [Dn, vv] (vv: value) to be transmitted.

When the N1R receives this message, it can apply an aftertouch effect.

There is another type of aftertouch, **Polyphonic Key**

Pressure [An, kk, vv] (kk: note number, vv: value), which applies an effect independently for each note. The N1R is able to receive this message.

Applying pitch bend

When you move the [PITCH BEND] wheel of a connected MIDI keyboard, **Pitch Bend** messages [En, bb, mm] (bb: lower byte of the value, mm: upper byte of the value; together indicating a total of 16384 steps with center value at 8192 [bb and mm = 00H, 40H]) will be transmitted.

When the N1R receives this message, pitch bend will be applied. You can also adjust the range of the pitch bend (the depth of the pitch change) via MIDI. (Refer to "Changing the pitch bend range.")

Adjusting the volume

When **Volume** messages [Bn, 07, vv] (control change #07) (vv: value) are received, the volume will change. However the volume of the N1R is determined by the product of the value of the Volume message and the value of the **Expression** message [Bn, 0B, vv] (control change #11) (vv: value). This means that if the volume does not increase sufficiently in response to Volume messages, or if there is no sound, you should try transmitting a MIDI Expression message with a value of 127.

A sequencer (or a computer with sequencer software) that is connected to the N1R can control the volume of each part (track) in the song. You should use Volume messages in the setup data for each part (i.e., the data at the beginning of the song which specifies the volume balance between the parts), and use Expression messages to adjust the volume during the song.

If you include Volume messages in the music data, that track may be set to an unintended volume.

By using the Universal Exclusive message Master Volume (refer to "About system exclusive messages"), you can adjust the overall volume without changing the balance between timbres or parts.

Applying vibrato (PITCH LFO)

When the [MODULATION] wheel of a connected MIDI keyboard is moved away from yourself, **Modulation 1 Depth** messages [Bn, 01, vv] (control change #01) (vv: value) will be transmitted.

When the N1R receives these messages, vibrato will be applied.

Adjusting the stereo location (Panpot)

The output destination of the oscillators, timbres and parts of the N1R is determined by the L and R Panpot, Send C and Send D settings (= effect inputs A, B, C and D). In particular, the panpot for timbres and parts can be adjusted by MIDI **Panpot** messages [Bn, 0A, vv] (control change #10) (vv: value, where 00 is L, 64 is center, and 127 is R).

Adjusting the effect send levels (Send C, D)

The output destination of the N1R's oscillators, timbres and parts is determined by the L and R Panpot and by Send C and Send D (= effect inputs A, B, C and D). In particular, the Send C setting for timbres and parts is

adjusted by the **Reverb Level** message [Bn, 5B, vv] (control change #91) (vv: value), and the **Send D** setting by the **Chorus Level** message [Bn, 5D, vv] (control change #93).

These messages are merely defined for use in adjusting the effect levels, and will not necessarily perform the same function on other devices.

If these messages are received while a note is sounding, the change in effect send level will not occur immediately, but will take effect from the next played note.

Turning effects on/off

The two effect units can be switched on/off independently, by using **Effect Switch 1** messages [Bn, 5C, vv] (control change #92) (vv: value, where 00 is off and 127 is on) and **Effect Switch 2** messages [Bn, 5F, vv] (control change #95). These messages are merely defined for use in adjusting the effect levels, and will not necessarily perform the same function on other devices.

Effect dynamic modulation

You can select a dynamic modulation source and operate that source to control effects.

For example if you wish to use MIDI Aftertouch for control, you must first select aftertouch (AFTER.T) as the dynamic modulation source (MOD.SRC) for that effect. Then when MIDI Aftertouch messages are received, dynamic modulation will be applied.

Regardless of the modulation source settings, effects 1 and 2 can be controlled by **Effect Control 1** [Bn, 0C, vv] (control change #12) (vv: value). (This can be used in the same way as Effect Control 1.) These messages are received on the MIDI channel of the Upper part in Performance Play mode, and on the Global mode <Exclusive Channel> MIDI channel in Multi mode.

Adjusting the tone

MIDI **Brightness** messages [Bn, 4A, vv] (control change #74) (vv: value) can be received to adjust the tone color. For a 'vv' value of 64 [40H], there will be no change in the tone. For lower values the sound will become darker, and for higher values the sound will become brighter.

However since this message has come into use only recently, it may not be implemented on some instruments.

Adjusting the attack time

When a MIDI **Attack Time** message [Bn, 49, vv] (control change #73) (vv: value) is received, the attack time will change. For a value of 64 [40H] there will be no change in the attack time. For lower values the attack will become faster, and for higher values the attack will become slower.

However since this message has come into use only recently, it may not be implemented on some instruments.

Adjusting the release time

When a MIDI **Release Time** message [Bn, 48, vv] (control change #72) (vv: value) is received, the release time will change. For other details, refer to the explanation of "Adjusting the attack," above.

Editing with RPN messages

RPN (Registered Parameter Number) messages allow settings to be made in the same way for instruments of different manufacturers. In contrast, NRPN (Non-registered Parameter Number) messages and exclusive messages can be used freely by each instrument manufacturer.

To edit using RPN messages, use the following procedure.

- ① Use RPN (LSB) [Bn, 64, rr] and RPN (MSB) [Bn, 65, mm] messages (control changes #100 and #101) (rr, mm: parameter number lower and upper bytes) to specify the parameter.
- ② Use Data Entry (MSB) [Bn, 06, mm] and Data Entry (LSB) messages [Bn, 26, vv] (control changes #06 and #38) to specify the value. ('mm' and 'vv' are the upper and lower bytes, allowing a total of 16384 steps.)

You can also use Data Increment [Bn, 60, 00] (control change #96: value fixed at 00) or Data Decrement [Bn, 61, 00] (control change #97: value fixed at 00) messages to increase or decrease the value in steps of 1.

The N1R receives the three types of RPN message described below (tuning, transposing, and setting the pitch bend range).

Tuning

You can use RPN messages to adjust the Detune setting of each part. (Use the MIDI channel for each part.)

Use the following procedure.

- ① Select RPN 01.
Transmit to the N1R a message of [Bn, 64, 01, 65, 00] (control change #100 with a value of 01, and #101 with a value of 00).
- ② Use Data Entry messages to adjust the value.
Use [Bn, 06, mm, 26, vv] (control change #06 and #38) to adjust the value. A value of 8192 [mm, vv = 40H, 00H] is center (normal pitch). A value of 0 is -100 cents, and a value of 16383 [mm, vv = 7FH, 7FH] is +100 cents.

Transposing

You can use RPN messages to set the Transpose setting of each part. (Use the MIDI channel for each part.)

Use the following procedure.

- ① Select RPN 02.
Transmit to the N1R a message of [Bn, 64, 02, 65, 00] (control change #100 with a value of 02, and #101 with a value of 00).
- ② Use Data Entry messages to adjust the value. However, normally only the upper byte is used.
Use [Bn, 06, mm] (control change #06). A value of 8192 (mm=64=40H) is center (normal pitch). A value of 6656 (mm=52=34H) is -12 semitones, and a value of 9728 (mm=76=4CH) is +12 semitones.

Setting the pitch bend range

You can use RPN messages to adjust the pitch bend range for each part. (Use the MIDI channel for each part.)

Use the following procedure.

- ① Select RPN 00.
Transmit to the N1R a message of [Bn, 64, 00, 65, 00] (control change #100 with a value of 00, and #101 with a value of 00).
- ② Use Data Entry messages to adjust the value. However, normally only the upper byte is used.
Use [Bn, 06, mm] (control change #06). A value of 00 (mm = 00) sets a pitch bend range of 0, and a value of 1536 (mm = 12 = 0CH) sets a pitch bend range of +12 semitones (1 octave). The N1R allows negative values to be set as well, but only positive values can be set using RPN messages.

Editing with NRPN messages

NRPN (Non-Registered Parameter Numbers) are messages which can be used freely by each instrument manufacturer. The N1R receives NRPN messages to edit several parameters of Part Edit mode, which are designed to be compatible with the messages of another manufacturer's format. NRPN messages can be received to edit Vibrato Rate/Depth/Delay, Cutoff and EG Times, and the Cutoff, EG Time, Tuning, Volume, Panpot, and Send C and D etc. for each instrument of a drumkit.

Editing procedure is as follows.

- ① Use NRPN (LSB) [Bn, 62, rr] and NRPN (MSB) [Bn, 63, mm] (control changes #98 and 99 (rr, Multi mode: lower and upper byte of the parameter number) to select the parameter.
- ② Use Data Entry (MSB) [Bn, 06, mm] (control change #06) (mm: value) to specify the value.

Adjusting the tuning within a drumkit

As an example of control using NRPN messages, here's how to adjust the tuning of the snare for the drumkit of part 10.

Use the following procedure.

- ① Set NRPN MSB to 18H to select Drum Coarse Tune, and set LSB to 28H to select the drumkit instrument Snare (E2).
Transmit [Bn, 62, 18, 63, 28] (control change #98 with a value of 24, #99 with a value of 40).
- ② Use Data Entry to set the value. Only the upper byte is used.
This is done by transmitting [Bn, 06, mm] (control change #06). A value of 8192 (mm=64=40H) is center (normal pitch). A value of 6656 (mm=52=34H) is -12 semitones, and a value of 9728 (mm=76=4CH) is +12 semitones.

If a note is "stuck"

If for some reason a note "sticks" (i.e., continues to sound without stopping), moving to a different mode will normally solve the problem. Disconnecting the MIDI cable will also stop a note which was sounded via MIDI.

MIDI devices transmit a message known as Active Sensing [FE] at regular intervals. This allows a device that receives this message to know that an external MIDI device is connected. Then, if no MIDI messages are received for a certain length of time, the receiving device will decide that the connection has been broken, and will turn off notes and reset controller values that were received via MIDI.

Turning off all notes of a channel

When an All Note Off message [Bn, 7B, 00] (control change #123, data of 00) is received, all notes currently sounding on that channel will be turned off (as though you had released them on the keyboard).

An All Sound Off message [Bn, 78, 00] (control change #120, data of 00) will stop all sound being produced on that channel. While an All Note Off message allow note decays to continue, the All Sound Off message will stop the sound immediately.

These messages are only for use in emergency situations, and are not used while you play.

Resetting all controllers of a channel

When a Reset All Controllers message [Bn, 79, 00] (control change #121, data of 00) is received, the values will be reset for all controllers currently being used on that channel.

System exclusive messages

Since manufacturers are free to use system exclusive messages in any way they please, these messages are used mainly to transmit and receive sound data or editing data for parameters that are unique to a given model of instrument.

On the N1R, the system exclusive message format is [F0, 42, 3n, 4C,, F7] (n: exclusive channel).

However, some exclusive messages are defined to have a specific purpose common to all manufacturers. These are called universal system exclusive messages.

The N1R supports the following universal system exclusive messages.

- When an Inquiry Message Request message [F0, 7E, nn, 06, 01, F7] is received, the N1R will respond with an Inquiry Message [F0, 7E, nn, 06, 02, (nine bytes), F7] that means "I am a Korg N1R, system version ..."
- When a GM System On [F0, 7E, nn, 09, 01, F7] message is received, the N1R will switch to Multi mode, and will be initialized to GM settings.
- A Master Volume message [F0, 7E, nn, 04, 01, vv, mm, F7] (vv: lower byte of value, mm: upper byte of value; together expressing 16384 steps) can adjust the overall volume while preserving the volume balance between timbres of a combination, or between parts.

- A Master Balance message [F0, 7E, nn, 04, 02, vv, mm, F7] (vv: lower byte of value, mm: upper byte of value; together expressing 16384 steps, where 8192 is the initial setting, and lower values will move increasingly to the left) can adjust the overall pan position while preserving the relative pan position between timbres in a combination or between parts.

Transmitting sound data settings etc. (Data Dump)

Program sounds, combination sounds, drumkits, and global settings can be transmitted as MIDI exclusive data. The transmission of MIDI exclusive messages to an external device is referred to as a "data dump."

- In the Global mode <MIDI Data Dump> page, you can select the type of data, select whether the data will be transmitted from MIDI OUT or from PC I/F, and execute the data dump to transmit the specified type of data from internal memory.
- If the Global mode <MIDI Filter> EXCL parameter is set to "O," data dumps will also be transmitted when a Dump Request message is received.

This data is transmitted and received on the Global mode <Exclusive Channel>.

Synchronizing the arpeggiator

Synchronization of the arpeggiator playback with an external device can be specified in Performance Play mode or Multi mode. The Global mode <Clock Source> setting determines whether the N1R will be the master (the controlling device) or the slave (the device which is controlled).

When the Clock Source is set to INT (Internal), the N1R will be the master, and the arpeggiator speed can be controlled by the N1R. The notes generated by the arpeggiator will be transmitted via MIDI, and can play an external device connected to MIDI OUT. The tempo of an external sequencer can also be controlled.

When the Clock Source is set to MIDI or PCIF, the N1R will be the slave, and the arpeggiator speed will be determined by the incoming MIDI Clock messages. The arpeggiator can be controlled by MIDI messages.

```

Pattern select
[Bn 63 00 Bn 62 01 Bn 06 nn]
nn: 00-13
Arpeggio On/Off [Bn 63 00 Bn 62 02 Bn 06 nn]
nn: 00-3F (off), 40-7F (on)
Arpeggio Octave [Bn 63 00 Bn 62 03 Bn 06 nn]
nn: 00-03 (1-4 octaves)
Arpeggio Latch [Bn 63 00 Bn 62 04 Bn 06 nn]
nn: 00-3F (off), 40-7F (on)
Arpeggio Key Sync [Bn 63 00 Bn 62 05 Bn 06 nn]
nn: 00-3F (off), 40-7F (on)
    
```

Selecting effects

The effects that are selected in Multi mode or Performance Play mode can be switched via MIDI. For example if you wish to select effect u: 003 Flg-Rev, you would transmit the following system exclusive message:
F0, 42, 30, 4C, 12, 00, 00, 07, 50, 00, 03, F7
The underlined 50, 00, 03 are MSB, LSB, nn (nn: effect number).

Scale (temperament) settings

The temperament of the part selected in Multi mode or Performance Play mode can be adjusted. For example if you want the C note to be 10 cents higher for part 01, you would transmit the following system exclusive message:

F0, 42, 30, 4C, 12, 01, 00, 32, 4A, F7

The underlined 01, 00, 32, 4A are the part number (00H-1FH: part 01-32), note name (32H-3DH: C-B), and value (0H-40H: center value-7FH).

About GM/GS/XG

GM-compatibility means that sound selections etc. will function in the same way regardless of the manufacturer or model of instrument. However when using this, you should be aware of the following points.

- When the N1R receives a MIDI GM System On message [F0, 7E, nn, 09, 01, F7], it will switch to Multi mode, and will be initialized for GM operation.

Roland GS and Yamaha XG are expansions of the GM specification which Roland and Yamaha respectively have created on their own. The N1R supports the GS and XG sound maps and recognizes some of the messages.

You can specify whether or not these messages will be received or not by setting the Global mode <Receive Switch> parameters "GM On," "GS On" and "XG On."

Program bank names with "r" are for the GS sound map, and bank names with "y" are for the XG sound map.

MIDI filters

Global mode <MIDI Filter> settings allow you to enable/disable reception for program change, aftertouch, control change, and system exclusive messages.

In Combination Edit mode, the above messages (except for program change) as well as pitch bend can be enabled/disabled independently for each timbre.

Compatibility with the N1/N5

When a Global Dump is received from the N1/N5, the Damper Pedal Polarity value is maintained. This means that if a Global Dump is to be received from the N1R, that value will be output without change. For other parameters, see below.

On the N1R, the N1/N5 Global parameters <Local Switch> and <Key Shift Position> are replaced by <Keyboard Simulator> and <Arpeggio Out MIDI>. This means that when a Global Dump is received from the N1/N5, or when a Global Dump is transmitted from the N1R to the N1/N5, the Global parameters will be as follows.

N1/N5		N1R
Local=OFF		Single Ch.LAYER/SPLIT=OFF
Local=ON		Single Ch.LAYER/SPLIT=ON
Key Shift Pos=AfterKBD		Arpeggio OUT=OFF
Key Shift Pos=BeforeTG		Arpeggio OUT=ON

When a N1/N5 Performance Dump is received, the "Modulation Wheel Type" and "Assignable Pedal Type" values will be maintained within the N1R, and when a Performance Dump is transmitted from the N1R these values will be transmitted without change.

The N1R <Damper Assign> replaces the N1/N5 parameter <Assignable Switch Type>. When a Performance Dump is received from the N1/N5, values other than "Damper," "Lower Damper" or "Upper Damper" will be handled as "Damper."

Multi mode settings of the N1R are compatible with the N1, N5, NS5R, X5 and X5DR. However, of the 05R/W's Multi settings, only the effect settings are compatible with the N1R.

MIDI messages

Program/Combination/Bank List, Performance List

yDr1 Bank (Bank MSB=7EH)		*kDrum* Bank (Bank MSB=3EH)	
Program No. (PC# xxh)	Drum Kit Name	Program No. (PC# xxh)	Drum Kit Name
1 (00h)	SFX 1	1 (00h)	STANDARD
2 (01h)	SFX 2	2 (01h)	STANDARD
		9 (09h)	ROOM
		17 (11h)	ROCK
		25 (19h)	ELECTRO
		33 (27h)	ANALOG
		41 (35h)	DANCE
		49 (43h)	BRUSH
		57 (51h)	ETHNIC
		65 (59h)	RICKSHAW
		73 (67h)	SFX
		75 (69h)	C/W

yDr2 Bank (Bank MSB=7FH)		*kDrum* Bank (Bank MSB=3DH)	
Program No. (PC# xxh)	Drum Kit Name	Program No. (PC# xxh)	Drum Kit Name
1 (00h)	Standard	1 (00h)	STANDARD
2 (01h)	Room	2 (01h)	STANDARD
9 (09h)	Rock	9 (09h)	ROOM
17 (11h)	Electro	17 (11h)	POWER
25 (19h)	Analog	25 (19h)	ANALOG
33 (27h)	Brush	33 (27h)	ANALOG
41 (35h)	Classic	41 (35h)	DANCE
		49 (43h)	JAZZ
		57 (51h)	BRUSH
		65 (59h)	ORCHESTRA
		73 (67h)	ETHNIC
		75 (69h)	RICKSHAW
			SFX
			C/W

For an explanation of each bank, refer to the table on p.20.

Performance List

Performance Change

Bank Select (MSB:LSB) | SF:xx (LSB ignore)

Program No. | 00 to 1F (=Perform01 to 32)

MIDI Channel Message

Table 1-2: MIDI Channel Messages. Lists messages like Arpeggio Switch, Arpeggio Latch, Arpeggio Key Sync, Vibrato Rate, etc., with their MIDI hex codes and descriptions.

Table 1-3: MIDI Hex Codes. Lists hex codes for messages like Bank Select MSB, Bank Select LSB, Balance, Pitch Modulation, etc., with their descriptions.

Table 1-4: MIDI Hex Codes. Lists hex codes for messages like Local ON/OFF, Local ON/OFF (MIDI), MPO mode ON, etc., with their descriptions.

Table 1-5: MIDI Hex Codes. Lists hex codes for messages like RPN No. (Hex), RPN No. (LSB), RPN No. (MSB), etc., with their descriptions.

Table 1-6: MIDI Hex Codes. Lists hex codes for messages like Note On, Note Off, Program Change, Channel Pressure, etc., with their descriptions.

Table 1-7: MIDI Hex Codes. Lists hex codes for messages like Assignable Controller, Hold (On/Off), Expression, etc., with their descriptions.

Table 1-8: MIDI Hex Codes. Lists hex codes for messages like Assignable Controller, Hold (On/Off), Expression, etc., with their descriptions.

Part Parameter Change

Table 1-9: Part Parameter Change. A large table listing various parameters like Bank Select MSB, Program Number, RPN No., etc., with their hex codes and descriptions.

Center	\$40	\$00
\$58 (CmbU)	R63	\$7F \$00
\$59 (CmbA)	OFF	\$00 \$01
\$5A (CmbB)		
\$5B (CmbC)		
Other		

Default Parameters

(NR) (XG) (GS)	(Value)	(Description)
3n,rr,00 3n,rr,00	00-40-7F	Coarse Tune
3n,rr,01 3n,rr,01	00-40-7F	Fine Tune
3n,rr,02 3n,rr,02	00-40-7F	Level
3n,rr,03 3n,rr,03	00-40-7F	Excl Group
3n,rr,04 3n,rr,04	00-40-7F	Panpot
3n,rr,05 3n,rr,05	00-40-7F	Reusoph. Send
3n,rr,06 3n,rr,06	00-40-7F	Chorus Send
3n,rr,08 3n,rr,08	00-01	Key Assign Mode
3n,rr,09 3n,rr,09	00-01	Receive Note OFF
3n,rr,0A 3n,rr,0A	00-01	Receive Note ON
3n,rr,0B 3n,rr,0B	00-40-7F	Cutoff
3n,rr,0C 3n,rr,0C	00-40-7F	Color
3n,rr,0D 3n,rr,0D	00-40-7F	Attack Time
3n,rr,0E 3n,rr,0E	00-40-7F	Decay Time

Display

(NR) (XG) (GS)	(Value)	(Description)
08,00,00	00-7F	Display Letter 0
08,00,01	00-7F	Display Letter 1
08,00,20	00-7F	Display Letter 31
08,00,21	00-7F	Display Bitmap Data 0 (16 x 16 dots)
08,00,22	00-7F	Display Bitmap Data 1
08,00,23	00-7F	Display Bitmap Data 47
08,00,40	00-1F	Display Bitmap Data 0 (16 x 16 dots)
08,00,41	00-1F	Display Bitmap Data 1
08,00,42	00-1F	Display Bitmap Data 63
08,00,20	00-7F	Display Bitmap Data 0 (32 x 16 dots)
08,00,21	00-7F	Display Bitmap Data 1
08,00,22	00-7F	Display Bitmap Data 79

For Key format display bitmap data, 32 x 16 pixels of screen data are displayed for a fixed 16 x 16 dot matrix.

For key format display bitmap data, 32 x 16 pixels of screen data are displayed for a fixed 16 x 16 dot matrix.

bits 6-0 of each value correspond to pixels on the screen. Values and display locations correspond as follows.

bit	Address
6	00-40-7F
5	00-40-7F
4	00-40-7F
3	00-40-7F
2	00-40-7F
1	00-40-7F
0	00-40-7F

Reset/Other Infomation

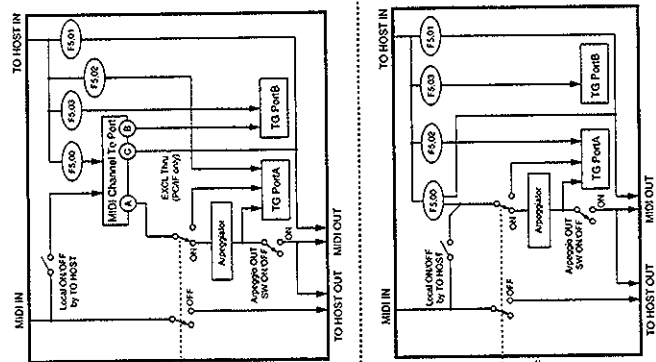

Settings produced when a GS Reset 'R' (GS reset) is received

- When OSC/MAP is received, one of two types of reset will occur, depending on the state at that time.
 - If a GS System ON is received following a GS Reset, the state will be the same as for GS Reset.
 - If a GS System ON is received following an XG System ON, the state will be the same as for XG System ON.
- The OSC/MAP state differs from the default map in the following ways.
 - Program changes for bank 00:00 (MSB:LSB) will select 'Prgr' sounds.
 - When a non-drumkit part is switched to a drumkit by a MIDI bank change + program number.
 - When OSC System ON is received,
 - Part 10 and Part 26 = 'MdrM:001 OH Kit' other Parts = 'OH-b:001 Piano'

Program changes for which the selected bank will differ depending on the status-

Bank:Prog	Bank Name	Bank	Prgr
00:00	OH-a		Prgr
00:01	OH-a		Y:01
7F:*	Y:CH		Y:02
78:*	Z:DM		Y:02

TO HOST INTERFACE TECHNICAL CHART

Band rate setting (refer to Global mode)

PC/FIF clock	Explanation
31.25 Kbps	Asynchronous 31.25 Kbps, 8 data bits, 1 stop bit, no parity bit
38.40 Kbps	Asynchronous 38.40 Kbps, 8 data bits, 1 stop bit, no parity bit

Local ON/OFF (refer to diagram)

- * Responds only to messages from TO HOST.

Temperature data

Temp	A	B	C	D	E	F	G	H	I	J	K
1. Equal Temperature	0	0	0	0	0	0	0	0	0	0	0
2. Pure Temperature (Temp)	+16	-14	+20	-31	-2	+14	-16	+18	-7	0	+38
3. Pure Temperature (Temp)	+16	+4	+3	+20	-3	+14	-10	+17	-7	0	+38
4. Pythagorean	+8	+8	-2	-12	-2	-4	-6	-4	+10	0	+10
5. Pythagorean III	+12	+2	+4	+6	+10	+14	+18	+4	+8	0	+8
6. Weinberger III	+10	+1	+3	+4	-3	+4	-3	+1	+7	0	+7
7. Weinberger III	+8	0	+2	+4	-2	+4	-2	+1	+4	0	+4
8. Valois & Young	+8	0	+2	+4	-2	+4	-2	+1	+4	0	+4
9. Arabian style tuning	-8	+4	+1	-12	-31	-2	+14	-7	0	0	-10

Temperature

- Equal Temperature
- Pure Temperature (Temp)
- Pure Temperature (Temp)
- Pythagorean
- Pythagorean III
- Weinberger III
- Weinberger III
- Valois & Young
- Arabian style tuning

Settings produced when a R-Reset 'Y' (XG System ON) is received

- Default map will be selected. (Map condition is temporary, and will not be selected if the bank is 'A:001 Rev/Ch').
- Program changes for bank 00:00 (MSB:LSB) will select 'GN-a' bank sounds.
- Program changes for bank 7F:00 (MSB:LSB) will select 'Y:01' bank sounds.
 - Program changes for bank 7F:01 (MSB:LSB) will select 'Y:02' bank sounds.

Settings for each part

Part	Bank:Prog	Rx BankSelect
Part1	GN-a:001 Piano 1	ON
Part9	GN-a:001 Piano 1	ON
Part10	SPANDM	OFF
Part11	GN-a:001 Piano 1	ON
Part16	GN-a:001 Piano 1	ON
Part17	GN-a:001 Piano 1	ON
Part25	GN-a:001 Piano 1	ON
Part26	GN-a:001 Piano 1	ON
Part27	GN-a:001 Piano 1	ON
Part32	GN-a:001 Piano 1	ON

Initialization by reception of GS System ON, GS Reset and XG System ON

- All control elements, all part parameters and all performance parameters will be initialized.
- For parts 1-16, when a non-drumkit part is switched to a drumkit by a bank change + program change, the part mode will be Multi.
- For parts 17-32, when a non-drumkit part is switched to a drumkit by a bank change + program change, the part mode will be Multi.
- When OSC System ON is received,
 - When OSC System ON or GS System ON is received, the mode will be Multi mode.

Settings produced when a R-Reset 'R' (GS reset) is received

- Map condition is temporary, and will not be saved to Global.
- Effect will be 'A:001 Rev/Ch'.
- Program changes for bank 00:00 (MSB:LSB) will select 'GN-a' bank sounds.
- Program changes for bank 7F:00 (MSB:LSB) will select 'Y:01' bank sounds.
- On this instrument, reception of GS SYSTEM SOUND SET (Roland SC88) will have the same effect as when a R-Reset 'R' (GS reset) is received.

Part	Bank:Prog	Rx BankSelect
Part1	GN-a:001 Piano 1	ON
Part9	GN-a:001 Piano 1	ON
Part10	SPANDM	OFF
Part11	GN-a:001 Piano 1	ON
Part16	GN-a:001 Piano 1	ON
Part17	GN-a:001 Piano 1	ON
Part25	GN-a:001 Piano 1	ON
Part26	GN-a:001 Piano 1	ON
Part27	GN-a:001 Piano 1	ON
Part32	GN-a:001 Piano 1	ON

Voice Name List

Performance

Bank Select MSB=95, LSB=Ignored

PC	Upper	Lower	Type	Arpeggio Type
1	CmbU 0 Alignment	GM-a 1 Piano 1	-	4 ALT2
2	CmbU 42 IceClimber	PrgA 26 ReMixBass	Split	12 B-TECHNO
3	CmbU 25 Mr."BX-3"	CmbB 49 RapToolKit	Split	18 D-JUNGLE
4	CmbC 50 Encounters	PrgA 43 CoCo	Layer	7 ARP 2
5	PrgC 84 Wah Clav	CmbB 9 Dance Trak	Split	17 D-TECHNO
6	CmbU 16 Hip House	PrgB 56 Deep House	Split	12 B-TECHNO
7	CmbB 76 Bass/Brass	KDrm 26 Analog Kit	Split	17 D-TECHNO
8	CmbB 64 Maya Dance	CmbB 64 Maya Dance	Split	15 B-SOUL
9	PrgU 71 N1 Dyno EP	PrgB 36 Stein Bass	Split	14 B-FUNK
10	CmbA 17 BigStrings	CmbB 27 Nutcracker	Layer	17 D-TECHNO
11	CmbA 70 Uni Verse	PrgC 56 Bass Zap	Split	10 ARP 5
12	CmbU 23 Indian Jam	CmbC 23 Ghame Jana	Split	20 D-R&B
13	CmbU 74 WaveGuitar	PrgA 96 ChromeBass	Split	13 B-DANCE
14	CmbB 49 RapTooKit	yDr2 26 Analog	Split	20 D-R&B
15	CmbC 54 Dole Bee	CmbB 6 House Mix	Split	14 B-FUNK
16	CmbU 79 Beam Me Up	CmbU 59 Borg Space	Split	11 ARP 6
17	CmbA 93 Morocco	kDrm 26 Analog Kit	Split	17 D-TECHNO
18	CmbB 73 Botswana	CmbA 73 Wet Lands	Split	13 B-DANCE
19	CmbU 1 Zinger EP	CmbC 13 Percolator	Layer	6 ARP 1
20	CmbB 16 PhaseTwins	CmbU 36 Rezzo Rave	Split	14 B-FUNK
21	CmbU 12 12ToneBelz	CmbB 90 InTheMaze	Split	6 ARP 1
22	CmbU 54 Gtr/Flute	CmbU 86 Latin Band	Split	15 B-SOUL
23	CmbA 10 Melotronic	CmbU 6 VoxD'House	Split	12 B-TECHNO
24	CmbU 76 BS&StPiano	yDr2 41 Brush	Split	20 D-R&B
25	CmbA 91 Accordion	CmbB 94 Bavaria	Split	9 ARP 4
26	CmbA 90 Fade Away	CmbB 80 Rezolution	Split	6 ARP 1
27	CmbA 76 Bass&Vibes	rDrm 41 BRUSH	Split	17 D-TECHNO
28	CmbB 30 First*Snow	CmbC 80 Alienesque	Split	5 RANDOM
29	CmbB 98 Lead & Pad	CmbA 64 Oh-La-La !	Split	2 DOWN
30	CmbU 95 Eruption	CmbU 5 Fast Perc	Split	16 B-JAZZ
31	CmbC 90 FirstLight	CmbU 70 Luminous	Layer	5 RANDOM
32	PrgB 88 03R/WPulse	PrgA 38 Xanalog	Layer	4 ALT2

CmbU

Bank Select MSB=88, LSB=Ignored

PC	Name
0	Alignment
1	Zinger EP
2	Acappella
3	Rain Dance
4	Blue Bass
5	Fast Perc
6	VoxD'House
7	Midnight
8	Pulse:Mod
9	FilmDrama
10	Moonrise
11	PianoMagic
12	12ToneBelz
13	Afro/Cuban
14	CrankitUp!
15	SwingHorns
16	Hip House
17	Sweeteners
18	Mega Pulse
19	Wild Rave
20	Flangesty
21	Dynamite
22	Goodbyes
23	Indian Jam
24	FolkGuitar
25	Mr. "BX-3"
26	Dyno Split
27	Pizz A Pie
28	DroidRoad
29	DJ*ToolBox
30	Futurist
31	Cyclic EP
32	Vox Bells
33	NightTrain
34	Tune Smith
35	16 Horns
36	Rezzo Rave
37	LegatoReed
38	CanyonView
39	UnderWorld
40	Dizzying
41	Vox King
42	IceClimber
43	Zen Garden
44	Iron Layer
45	GreatOrgan
46	ForceField
47	The Loner
48	New Rave
49	Stereo Kit

CmbA

Bank Select MSB=89, LSB=Ignored

PC	Name
50	Chem Lab
51	Beefy EP
52	Wordless
53	Discovery
54	Gtr/Flute
55	Fanfare
56	Virtuals
57	5000 BC
58	TheModKnob
59	Borg Space
60	DreamPulse
61	InYourEyes
62	The Light
63	Big Ben
64	Mr. Metal
65	N1JazzMan
66	Split Bass
67	Strings
68	PureAnalog
69	Invaders
70	Luminous
71	Ballad EP
72	Nashville
73	Witch Hunt
74	WaveGuitar
75	Trpt&Bones
76	BS&StPiano
77	Heavy Bows
78	TheLastOne
79	Beam Me Up
80	Generators
81	ProStageEP
82	Child Song
83	Istanbul
84	RezStakBS
85	OverLoad!
86	Latin Band
87	FreshRosin
88	GlassPipes
89	Elements
90	PowderSnow
91	Mouth Harp
92	Sea Horses
93	Trinidad
94	AtTheFeast
95	Eruption
96	CelticBand
97	HarpString
98	Unison
99	MotherShip

PC	Name
0	Megatron
1	Rock Piano
2	Boys Choir
3	SongOfLife
4	StickSplit
5	Stax Organ
6	NeuroFunk
7	NightMusic
8	Hard Sync
9	Slammin'
10	Melotronic
11	Power Comp
12	TheRedSun
13	Ethnetic
14	Guitar Man
15	MutedHorns
16	Euroman
17	BigStrings
18	SkyCatLead
19	HouseOfSki
20	Warriors
21	Velo EP
22	Dreaming
23	IndianOrch
24	12 String
25	Deep Organ
26	SplitOrgan
27	Pizz & Bow
28	ODriveLead
29	PowerHouse
30	FreeTime
31	Emmabarna
32	VoxGamelan
33	EastAfrica
34	Fat Pluck
35	Big Band
36	RezzoSplit
37	Sonata
38	Maxi Stab
39	Sea Storm
40	Vectoring
41	The Gospel
42	LunarBells
43	Sting&Wind
44	Slap & Pop
45	WeddingDay
46	Type Aline
47	DelayedHit
48	Have Fun
49	Wild Drums

PC	Name
50	Mast World
51	FunkySpice
52	Voices2Men
53	TheGamelan
54	Chorus Gtr
55	Full Brass
56	Orch Split
57	The Finale
58	CymbalLife
59	HeadHunter
60	L.F.O.City
61	Power Keys
62	Aquarium
63	Ice Bells
64	Oh-La-La !
65	Super Jazz
66	MasterFunk
67	ChamberStr
68	LayerSynth
69	Space Port
70	Uni Verse
71	Stak'oMidi
72	Airiana
73	Wet Lands
74	Guitar&Pad
75	Trombhorns
76	Bass&Vibes
77	Double Bow
78	Sophism
79	Dagobar
80	TheyAppear
81	Piano Pad
82	Milagro
83	RhythmPipe
84	DynamoBass
85	Rock Organ
86	Osaka Jazz
87	Leti Theme
88	Pad+Alpha
89	<N> File
90	Fade Away
91	Accordion
92	Moon Stone
93	Morocco
94	Dulcimer
95	FullManual
96	GiantSplit
97	Bolshoi
98	Synth Fat
99	TimeTunnel

Appendices

CmbB

Bank Select MSB=90, LSB=Ignored

PC	Name
0	Pollenesk
1	Fat Pianos
2	TheSingers
3	NeverLand
4	World Bass
5	L'ilBit O'
6	House Mix
7	Allegro
8	Rezzo Funk
9	Dance Trak
10	SunOffTron
11	EP&String
12	AlienSings
13	Hot Salsa
14	InTheArena
15	SmokyHorn
16	PhaseTwins
17	AnaStrings
18	Sync Home
19	EtherScape
20	Star*Burst
21	Super EP
22	Star Lense
23	Calcutta
24	Malaguena
25	O.D. Organ
26	Bass/Horn
27	Nutcracker
28	PowerStack
29	Rave Hits
30	First*Snow
31	SamAntic
32	SilkRoad33
33	AfricaMood
34	12 Stereo
35	PhantomSax
36	BiggerIdea
37	Serenade
38	Ruff&Ready
39	Worm Hole
40	Galaxia
41	Two In One
42	Bell Come!
43	TheOldWest
44	Slappin'
45	Mixture
46	BreakADish
47	WoodSector
48	Multi Rez
49	RapToolKit

CmbC

Bank Select MSB=91, LSB=Ignored

PC	Name
0	The Abyss
1	StereoKeys
2	<<Heaven>>
3	Pacifica
4	Slap Stick
5	Grinding B
6	Green Rave
7	Delicato
8	Big Swell
9	RagaTrance
10	QuarkSpark
11	PianoSings
12	New Worlds
13	Percolator
14	Velo Chord
15	SweetMutes
16	Asidic
17	StringsAtk
18	Rezzo Comp
19	HouseParty
20	Vaporizer
21	MIDI EP-Pad
22	Lassie&Tim
23	Ghame Jana
24	Folk Picks
25	Hippy's
26	Piano&Str
27	Velo-Pizz
28	PolyChords
29	TheBigBang
30	SolarFlare
31	LayerPiano
32	PizzoSynth
33	The Sphinx
34	ShoeString
35	MillerTime
36	Anna Split
37	WoodWinds
38	AnalogKing
39	RainForest
40	Beach Walk
41	Satellite
42	Rain Chime
43	Sir Robin
44	Acid Tools
45	PipeOrgan
46	Busy Split
47	Madrigal
48	ChrisTall
49	Marching

• In addition to these combination sounds, there are two more sounds in Bank yDr1.

PrgU

Bank Select MSB=80, LSB=Ignored
MSB=0, LSB=0 (05R/W Map)

PC	Name
0	Expansions
1	St. Piano
2	BigBadBari
3	Droid Beat
4	RosewoodGt
5	Rock Organ
6	WalkinBass
7	Symphony
8	Modular 3C
9	Techno Kit
10	Color Pad
11	N1WhirlyEP
12	Big Brass
13	Band Hit
14	AcousticGT
15	VintageBX3
16	Solid Bass
17	LightVoice
18	Solo Synth
19	Harp Gliss
20	PlanetS+H
21	DWGS Dream
22	Reed&Flute
23	Throbmastr
24	Air Guitar
25	N1JazzOrg
26	AnaSawBass
27	WindString
28	Mega Keys
29	Power Drum
30	GlideSweep
31	N1 A.Piano
32	TP & Brass
33	Visitors
34	PedalSteel
35	StageOrgan
36	SuperRound
37	Divisi
38	SynthBrass
39	ODRaveKit
40	AnaSquares
41	N1StageEP
42	V.S. Brass
43	PluggedIn
44	Strummers
45	SmallPipes
46	Slap&Slide
47	MixedChoir
48	Pizarro's
49	SteelDrums

PrgA

Bank Select MSB=81, LSB=Ignored

PC	Name
0	RunawayPad
1	N Piano
2	Tenor&Alto
3	Chord Vox
4	Flamenco
5	RockSteady
6	Upright
7	N Strings
8	LA Synth
9	Street Kit
10	Alaska
11	PF&Strings
12	Octa Brass
13	Rave Mix
14	BriteSteel
15	Rotary Org
16	BassPicker
17	Boys Choir
18	MonoLead
19	TheSunrise
20	Vortex
21	VS E.Piano
22	Dyno Flute
23	WhiteNoise
24	Bouzouki
25	Jazz Organ
26	ReMixBass
27	Air Vox
28	Stab Pad
29	Lazer Toms
30	Sunrise
31	Rock Piano
32	Classic TP
33	Velo rez
34	HollowBody
35	R&B Organ
36	SweetStick
37	TheStrings
38	Xanalog
39	VeloGated
40	Swell Pad
41	Vintage EP
42	Brass Ens1
43	Coco
44	Parker Gt
45	Full Pipes
46	Slap It
47	VocalChoir
48	MiniODLead
49	Gamelan

PC	Name
50	Universe X
51	Piano Pad
52	FlugelHorn
53	SynMallet
54	Mr. Clean
55	60's Organ
56	Dance Bass
57	Quick Bows
58	Fresh Air
59	VoodooSong
60	Antartica
61	PowerPiano
62	AvantGarde
63	DreamWorld
64	TubeCrunch
65	Mixture
66	NuFretless
67	Aggiatato
68	Split Sync
69	[KrazyKit]
70	LandingPad
71	NightTines
72	SalsaHorns
73	Up We Go
74	TheRipper
75	DanceOrgan
76	FatRezBass
77	ViolinSect
78	Pulsator
79	DreamBells
80	In The Pad
81	LA Layer
82	Big Band
83	Stereo Hit
84	Funk Clav
85	Polka Box
86	Ultra Rez
87	Light Pizz
88	AT Rsonanz
89	[Jet star]
90	Fragments
91	SuperTines
92	Trombones
93	CyberTrash
94	Mandolin
95	BX3 Medium
96	ChromeBass
97	SopranoVox
98	Syn Brass
99	Logs&Bells

GM-a/r:Bank/y:Bank

Bank Select r:Bank MSB=r:Bank No., LSB=0
Bank Select y:Bank MSB=0, LSB=y:Bank No.

Table with columns PC, rBank, yBank, Instrument. Rows include 49-56 (Strings, Choir, Synths), Brass (Trumpet, Trombone, Tuba), and 63 (Synth Brass).

Table with columns PC, rBank, yBank, Instrument. Rows include 63-88 (Brass, Reed, Pipe, Synth Lead, Synth Effects).

Table with columns PC, rBank, yBank, Instrument. Rows include 88-101 (Synth Pad, Synth Effects, Percussive).

GM-a/r:Bank/y:Bank

Bank Select r:Bank MSB=r:Bank No., LSB=0
Bank Select y:Bank MSB=0, LSB=y:Bank No.

Table with columns PC, rBank, yBank, Instrument. Rows include 101-118 (Percussive, Ethnic, Percussive).

Table with columns PC, rBank, yBank, Instrument. Rows include 118-128 (Sound Effects, Percussive).

ySFX Bank

Bank Select MSB=64, LSB=0

Table with columns PC, Instrument. Rows include 1-116 (CutNoise, Dog, Gallop, Bird, Kitty, etc.).

Table with 4 columns: No., Sample Name, Excl, and OFF. Rows include C1, D1, E1, F1, G1, A1, B1, C2, D2, E2, F2, G2, A2, B2, C3, D3, E3, F3, G3, A3, B3, C4, D4, E4, F4, G4, A4, B4, C5, D5, E5, F5, G5, A5, B5, C6, D6, E6, F6, G6, A6, B6, C7, D7, E7, F7, G7, A7, B7, C8.

Table with 6 columns: No., Sample Name, Excl, No., Sample Name, Excl. Rows include C0, D0, E0, F0, G0, A0, B0, C1, D1, E1, F1, G1, A1, B1, C2, D2, E2, F2, G2, A2, B2, C3, D3, E3, F3, G3, A3, B3, C4, D4, E4, F4, G4, A4, B4, C5, D5, E5, F5, G5, A5, B5, C6, D6, E6, F6, G6, A6, B6, C7.

Table with 12 columns: No., Sample Name, Excl, No., Sample Name, Excl, No., Sample Name, Excl, No., Sample Name, Excl. Rows include C0, D0, E0, F0, G0, A0, B0, C1, D1, E1, F1, G1, A1, B1, C2, D2, E2, F2, G2, A2, B2, C3, D3, E3, F3, G3, A3, B3, C4, D4, E4, F4, G4, A4, B4, C5, D5, E5, F5, G5, A5, B5, C6, D6, E6, F6, G6, A6, B6, C7.

Appendices

PrgA:39 VeloGated
PC PrgC:69 Zulu Kit
<Drumkit Select> 35 Zulu Kit

Table with 8 columns: No., Sample Name, Excl., No., Sample Name, Excl., No., Sample Name, Excl. Rows include C1, D1, E1, F1, G1, A1, B1, C2, D2, E2, F2, G2, A2, B2, C3, D3, E3, F3, G3, A3, B3, C4, D4, E4, F4, G4, A4, B4, C5, D5, E5, F5, G5, A5, B5, C6, D6, E6, F6, G6, A6, B6, C7, D7, E7, F7, G7, A7, B7, C8.

PrgU:39 ODRAveKit
38 User Kit 2

Table with 4 columns: G#0, No., Sample Name, Excl. Rows include A0, B0, C1, D1, E1, F1, G1, A1, B1, C2, D2, E2, F2, G2, A2, B2, C3, D3, E3, F3, G3, A3, B3, C4, D4, E4, F4, G4, A4, B4, C5, D5, E5, F5, G5, A5, B5, C6, D6, E6, F6, G6, A6, B6, C7, D7, E7, F7, G7, A7, B7, C8.

Multisample

Table with 2 columns: No., Sample Name. Rows include 0 A.Piano1, 1 A.Piano1w, 2 A.Piano1LP, 3 A.Piano2, 4 A.Piano2w, 5 M1Piano, 6 M1Pianow, 7 GrandEP, 8 E.Piano1, 9 E.Piano1w, 10 E.Piano1LP, 11 E.Piano2, 12 E.Piano2w, 13 E.Piano2LP, 14 SoftEP, 15 SoftEPLP, 16 HardEP, 17 HardEPw, 18 HardEPLP, 19 StageEP, 20 StageEPw, 21 PianoPad1, 22 PianoPad2, 23 Clav, 24 Clavw, 25 ClavLP, 26 Harpsicord, 27 Harpsicdw, 28 Harpsicdlp, 29 PercOrgan1, 30 PercOrg1LP, 31 PercOrgan2, 32 PercOrg2LP, 33 Organ1, 34 Organ1LP, 35 Organ2, 36 Organ2LP, 37 Organ3, 38 Organ4, 39 Organ5, 40 Organ6, 41 Organ6LP, 42 VoxOrgan1, 43 VoxOrgan2, 44 VoxOrgan3, 45 RotaryOrg1, 46 Rotary1LP, 47 RotaryOrg2, 48 SuperBX-3, 49 SuperBX3LP, 50 Dist.Organ, 51 Dist.OrgLP, 52 PipeOrgan1, 53 PipeOrg1LP, 54 PipeOrgan2, 55 PipeOrg2LP, 56 PipeOrgan3, 57 PipeOrg3LP, 58 CheeseOrg, 59 Musette, 60 MusetteV, 61 Bandneon, 62 BandneonLP, 63 Accordion, 64 AcordionLP, 65 Harmonica, 66 G.Guitar.

Table with 2 columns: No., Sample Name. Rows include 67 G.GuitarLP, 68 F.Guitar1, 69 F.Gtr1LP, 70 F.Guitar1V, 71 F.Guitar2, 72 A.GtrHarm, 73 E.Guitar1, 74 E.Guitar1V, 75 E.Guitar2, 76 E.Guitar3, 77 MuteGuitar, 78 FunkyGtr, 79 FunkyGtrV, 80 E.GtrHarm, 81 E.GtrHarmV, 82 DistGuitar, 83 DistGtrLP, 84 DistGtrV, 85 OverDrive, 86 OverDrvLP, 87 OverDrvF4, 88 MuteDstGtr, 89 MtDstGtrV, 90 DstGtrHarm, 91 PowerChord, 92 PowerChdV, 93 OverDvChrd, 94 PowerGtr, 95 PowerGtrV, 96 GtScratch, 97 GtrSlide, 98 GtCutNois1, 99 GtCutNois2, 100 Chic1, 101 Chic2, 102 Stick, 103 Sitar1, 104 Sitar2, 105 Sitar2LP, 106 Tambura, 107 TamburaLP, 108 Santur, 109 Bouzouki, 110 BouzoukiLP, 111 Mandolin, 112 Banjo, 113 Shamisen, 114 Koto, 115 Uood, 116 Harp, 117 Ukulele, 118 MandlinTrm, 119 A.Bass1, 120 A.Bass1LP, 121 A.Bass2, 122 A.Bass2LP, 123 E.Bass1, 124 E.Bass1LP, 125 E.Bass2, 126 E.Bass2LP, 127 PickBass1, 128 PicBass1LP, 129 PickBass2, 130 PickBass3, 131 Fretless, 132 FretlessLP, 133 SlapBass1, 134 SlapBass2, 135 SlpBass2LP.

Table with 2 columns: No., Sample Name. Rows include 136 SlapBass3, 137 SynthBass1, 138 SynthBass1LP, 139 SynthBass2, 140 SynthBass2LP, 141 SynthBass3, 142 RezBass1, 143 RezBass2, 144 RezBass3, 145 RezBass3LP, 146 MiniBass, 147 HouseBass, 148 FMBass, 149 FMBassLP, 150 BassSlide, 151 StringSlap, 152 Kalimba, 153 MusicBox, 154 MusicBoxLP, 155 LogDrum, 156 Marimba, 157 Marimbaw, 158 Xylophone, 159 SynMallet, 160 Vibe, 161 Vibew, 162 Celesta, 163 Glocken1, 164 Glocken2, 165 BrightBell, 166 B.BellLP, 167 MetalBell, 168 M.BellLP, 169 Gamelan, 170 Pole, 171 PoleLP, 172 Tubular, 173 ChurchBell, 174 FingCymbal, 175 FingCymbNT, 176 Gong, 177 GongLP, 178 SplitDrum, 179 SplitBell, 180 Flute, 181 TinFlute, 182 TinFluteLP, 183 PanFlute, 184 PanFluteLP, 185 Shakuhachi, 186 ShakhachiV, 187 ShakhachLP, 188 Bottle, 189 Recorder, 190 Ocarina, 191 Oboe, 192 EnglishHrn, 193 Eng.HornLP, 194 BassoonOboe, 195 BsonOboeLP, 196 Clarinet, 197 ClarinetLP, 198 Bari.Sax, 199 Bari.SaxLP, 200 TenorSax, 201 T.SaxLP, 202 AltoSax, 203 A.SaxLP, 204 SopranoSax.

Table with 2 columns: No., Sample Name. Rows include 205 S.SaxLP, 206 BagPipe, 207 Tuba, 208 TubalP, 209 Horn, 210 BrightHorn, 211 FlugelHorn, 212 Trombone1, 213 Trombone2, 214 Trumpet, 215 TrumpetLP, 216 MuteTP, 217 MuteTLP, 218 Brass1, 219 Brass1LP, 220 Brass2, 221 Brass2LP, 222 BrassFall, 223 StringEns., 224 StrEns.V1, 225 StrEns.V2, 226 StrEns.V3, 227 AnaStrings, 228 AnaStr.V1, 229 AnaStr.V2, 230 AnaStr.V3, 231 PWM, 232 Violin, 233 Viola, 234 Cello, 235 CelloLP, 236 Cbs.&Cello, 237 Pizzicato, 238 Voice, 239 Choir, 240 SoftChoir, 241 AirVox, 242 DooVoice, 243 DooVoiceLP, 244 SynVox, 245 SynVoxLP, 246 GlassVox, 247 WhitePad, 248 EtherBell, 249 E.BellLP, 250 Ghostly, 251 MegaPad, 252 SynthPad, 253 SynthPadA, 254 Spectrum1, 255 Spectrum2, 256 WaveSweep, 257 WaveSweepA, 258 WaveSweepB, 259 MouthHarp1, 260 MouthHrp1A, 261 MouthHarp2, 262 MouthHrp2A, 263 MouthHarps, 264 ChromRes, 265 WahFuzz, 266 Applause, 267 Stadium, 268 BrushNoise, 269 BruNoiseNT, 270 WhiteNoise, 271 WhiteNoiNT, 272 Jetstar, 273 JetstarLP.

Table with 2 columns: No., Sample Name. Rows include 274 JetstrLPNT, 275 BrushSwirl, 276 Thing, 277 ThingNT, 278 MarcTree1, 279 MrcTree1NT, 280 MarcTree1V, 281 MrcTre1VNT, 282 MarcTree2, 283 MrcTree2NT, 284 MarcTree2V, 285 MrcTre2VNT, 286 TriRoll, 287 TriRollNT, 288 TriRollV, 289 TriRollVNT, 290 Clicker, 291 ClickerNT, 292 CastRoll, 293 CastRollNT, 294 Lore, 295 LoreNT, 296 Waterphone, 297 Crickets1, 298 Crickets1NT, 299 Crickets2, 300 Crickets2NT, 301 MagicBell, 302 TronUp, 303 TronUpLP, 304 TronUpNT, 305 FluteFX, 306 FluteFXLP, 307 Flutter, 308 FlutterLP, 309 HarpUp, 310 HarpUpLP, 311 JungGliss, 312 JungGlissLP, 313 MalletLoop, 314 MalletLPNT, 315 Boogeta, 316 Sporing, 317 Rattle, 318 Kava, 319 Fever1, 320 Fever2, 321 Scratchar, 322 Zappers1, 323 Zappers2, 324 Bugs, 325 Surfy, 326 SleighBell, 327 Sagatty, 328 SagattyNT, 329 ElecBeat, 330 Idling, 331 EthnicBeat, 332 Tap-A, 333 Tap-B, 334 Tap-C, 335 Mini1a, 336 Digital1, 337 VS102, 338 VS48, 339 VS52, 340 VS58, 341 VS71, 342 VS72.

Appendices

Troubleshooting

Nothing appears in the LCD when I press the POWER switch!

- Is the AC/AC power supply connected?

No sound!

- Are the amp, mixer, and/or headphones connected correctly?
(Can you hear the demo playback? If you can, connections are correct.)
- Is the power of your amp and mixer turned on, and are they set correctly?
- Is the [VOLUME] knob of the N1R raised?
- Are you playing notes which do not produce sound due to split settings?
(Combination p.44)
- If the single-channel layer/split function is on and the Lower part produces no sound, are you receiving data on the MIDI channel of the Upper part?
Also, check whether the Global mode <Single-channel Layer/Split> setting is on (p.77).

Notes are stuck!

- Is the arpeggiator <Latch/Key Sync> set to LATCH or L&K.S?
(Try setting this parameter OFF, or stopping the arpeggiator.) (p.15, p.41)

Sound or operation is not what I edited!

- Did you execute the Write operation after editing? (p.35)
If you used the realtime controllers to edit, you must write the performance. (p.23)
- Was the program sound selected by a performance or combination sound edited subsequently?

Can't control via MIDI!

- Are the MIDI cables or special cable connected correctly?

When playing the N1R from an external device

- Have you made settings so that MIDI data is being received on the channel which the transmitting device is sending? (p.71)
- Is the Global mode <MIDI Channel To Port> parameter set to the channel you wish to use (A or B)? (p.78)
- Is the Global mode <MIDI Filter> set appropriately? (p.78)
- If you are playing a combination sound, has the Combination Edit mode <Receive Note On> parameter been turned OFF? (p.44)
Are any other combination sound parameters set incorrectly?

Can't control or hear when connected to a computer!

- Is the special cable connected correctly?
- Is the Global mode <BPS Select> setting appropriate for your computer? (p.7, p.8, p.76)
- On your computer, have you specified the MIDI port of the MIDI interface to which the N1R is connected, or the port of the Korg MIDI Driver?
- Are the amp, mixer and/or headphones connected correctly?

Can't write program sounds etc.!

- Is the Global mode <Write Protect> setting turned on? (p.35)

The drums I specified do not sound when I play the keyboard!

- Has the Global mode <Master Key Shift> been set to other than 00? (p.76)
- Has the Program Edit mode <Octave Select> been set to other than 8? (p.47)

Can't use MIDI program changes to select program sounds or combination sounds!

- Has the Global mode <MIDI Filter> PRG item been set to X? (p.78)
- Does the bank of the sound (program or combination) you are attempting to select match the MIDI bank select message you transmitted?

Can't select VDF2 or VDA2 parameters!

- Make sure that the <Oscillator Mode> of the currently selected program is set to DOUBLE. (p.46)

GM compatible song data does not playback correctly!

- Is the song data GM compatible?
- Has the Multi Part been initialized for GM? (p.32, p.71)
- Are the Global mode settings correct?
- If the volume or pan are incorrect, are the filters of the Korg MIDI Driver blocking this data?

Arpeggiator does not play correctly!

- If <Clock Source> in the Global mode is set either to MIDI or PCIF, are MIDI clock messages being properly transmitted from the external device?
- Is the clock source set to "Internal"?

Function	Transmitted	Recognized	Remarks	
Basic Channel	Default 1-16	1-16	Memorized	
Mode	Default Messages Altered	3 X *****		
Note Number:	X *****	0-127 0-127		
Velocity	Note On Note Off	X X	0 9n, V=1-127	
Aftertouch	Polyphonic (Key) Monophonic (Channel)	X X	O O	
Pitch Bend	X	O		
Control Change	0, 32 1, 5, 7 8, 10, 11, 12 6, 38 16, 17, 65 64, 66, 67 71, 72, 73, 75 74, 84 91, 93 92, 95 96, 97 98, 99, 100, 101 120, 121	O O O X O X O X X X X X X	O O O O O O O O O O O O O	Bank Select (MSB, LSB) Modulation, Portamento Time, Volume Balance, Panpot, Expression, Effect Control 1 Data Entry (MSB, LSB) General Purpose Controller 1, 2, Portamento Damper Pedal (Hold 1), Sostenuto, Soft Harmonic, EG Times (Release, Attack, Decay) Brightness, Portamento Control C send, D send Effect Switch 1, 2 Data Increment, Decrement NRPN (LSB, MSB), RPN (LSB, MSB) All Sound Off, Reset All Controllers
Program Change	Variable Range	O 0-127 *****	O 0-127 0-127	
System Exclusive		O	O	
System Common	Song Position Song Select Tune	X X X	X X X	
System Real Time	Clock Command	O O	O O	
Aux Messages	Local On/Off All Notes Off Active Sense Reset	X X O X	O O O X	
Notes				
*1: When Clock Source is Internal, transmitted and not received. (However, Continue is not transmitted). In the case of MIDI or PCIF, the opposite applies.				

Mode 1:OMNI ON, POLY Mode 2:OMNI ON, MONO O: Yes
Mode 3:OMNI OFF, POLY Mode 4:OMNI OFF, MONO X: No

Consult your local Korg distributor for more information on MIDI IMPLEMENTATION.

Specifications

N1R	
Type	AI-squared synthesis system (full digital processing)
Tone generator section	64 voices, 64 oscillators (single mode) 32 voices, 64 oscillators (double mode)
Waveform memory	PCM 18M Byte
Effect section	Two digital multi-effect units
Number of effects	48 effects
Number of programs	1269 (100 user, 1169 preset)
Number of combinations	402 (100 user, 302 preset)
Number of drumkits	39 (2 user, 37 preset)
Arpeggiator	20 types, 40-240 (BPM)
Outputs	1/L/MONO, 2/R, 3, 4
Headphone jack	Stereo phone jack
MIDI connectors	IN, OUT, THRU
Communication connector	TO HOST
Display	144 x 40 full dot LCD (with two-color backlight)
Power supply	AC 9V AC/AC power supply
Power consumption	AC 9V 1.7A (Max)
Dimensions	482(W) x 263.4(D) x 45(H) mm (19" x 10.4" x 1.8")
Weight	2.5kg (5.5 lbs.)
Included items	AC/AC power supply

Specifications and appearance are subject to change without notice for product improvement.

Options

- AG-001B IBM-PC connection kit (connection cable, "Korg MIDI Driver" software)
- AG-002B Macintosh connection kit (connection cable, "Korg MIDI Driver" software)
- MIDI cables

Index

A

- Active Sensing 89
 - Aftertouch 60, 86
 - Curve 78
 - Pitch Bend Range 56
 - Pitch LFO Intensity 48, 74
 - Pitch LFO Speed 48, 74
 - Receive- 44
 - VDA 56, 74
 - VDF 56
 - VDF LFO 56, 74
 - All Note Off 89
 - All Sound Off 89
 - Amp 28
 - Arpeggiator 15, 41
 - Setting 23
 - Synchronizing 89
 - ARPEGGIATOR 1 41
 - ARPEGGIATOR 2 42
 - Arpeggio
 - Gate 42
 - Octave 41
 - Out 77
 - Pattern 15
 - Sort 42
 - Speed 41
 - Step Base 42
 - Swing 42
 - Switch 41
 - Types 41
 - Velocity 42
 - Zone 42
 - ASSIGN 1-4 14
 - Assign Mode 57
 - ATTACK 14, 40
 - Attack Level 14
 - Pitch EG- 49
 - VDA EG- 54
 - VDF EG- 51
 - Attack Time 14
 - EG- 72
 - Pitch EG- 49, 73
 - Relative- 58
 - VDA EG- 54
 - VDF EG- 51
 - Auto Pan 68
- ### B
- BALANCE 13, 14
 - Bank 20, 38
 - Number 71
 - Select 18
 - Timbre 43
 - Bank Map Type 77
 - Bank names and their contents 20
 - Bend Wheel VDF 56
 - BNDWHL 73
 - BPS Select 8, 36, 76
 - Bypass 16, 39

C

- C Send Level 31, 33, 59
 - Drumkit 57
 - Multi 71
 - Program sound 29, 55
 - Timbre 43
- Caf 73
- Chorus 65
- Chorus-Delay 68
- Clock Source 76, 89
- Color
 - Intensity 50
 - Part 75
 - Relative- 58
 - Velocity Sensitivity 50
- Combination
 - Sound 12, 24, 86
- Combination Edit mode 24, 43
- COMBINATION EFFECT
 - PARALLEL 69
 - SERIAL 68
- Computer 7, 17
- Concert Hall 64
- Control 27
 - Section 29, 55
- Control knob 38, 40
- Cross Delay 64
- Crossover Chorus 65
- Crossover Flanger 66
- CUTOFF 14
- Cutoff Frequency
 - Effect 68, 70
 - Part 76
 - Performance 14, 40
 - Program sound 50
 - Relative 58

D

- D Send Level 31, 33, 59
 - Drumkit 57
 - Multi 72
 - Program sound 29, 55
 - Timbre 43
- Damper 13
 - Assign 39
- Data Dump 89
- Delay Start 47
- Delay/Chorus 69
- Delay/Distortion 69
- Delay/Flanger 69
- Delay/Hall Reverb 69
- Delay/Overdrive 69
- Delay/Phaser 70
- Delay/Room Reverb 69
- Delay/Rotary Speaker 70
- Demo 9, 34
- DISP 17
- Distortion 67
- DOUBLE 27, 46
- Drum program 18
- Drumkit 47
 - Select 47
 - Tuning 88
- Drumkit Edit mode 31, 57

DRUMS 27, 31, 46
 Drumsample 31, 32
 -Level 57
 -Select 57
 Dry Plate 64
 Dual Mono Delay 65
 Dynamic Modulation Source 60, 87

E

Early Reflection 64
 Edit Menu 20, 22, 24, 26, 30, 38
 Editing 16
 EFFECT 14
 Effect 17, 21, 89
 -Balance 60
 -Bank 30, 39, 45, 55
 Bypass 16, 39
 Combination sound 25, 30, 45
 Dynamic Modulation 14, 40, 87
 -Dynamic Modulation Intensity 60
 -Dynamic Modulation Source 60
 Multi mode 33
 -Number 45, 55
 off 87
 on 87
 Output Level 60
 Panpot 60
 -Parameter 62-70
 Performance 23, 39
 -Placement 30, 59
 -Program 39
 Program sound 29, 30
 -Rename 61
 Save 31, 35
 Send 31, 40, 43, 55, 58, 71, 87
 -Switch 60
 -Thru Switch 39
 -Type 59, 64
 Effect Edit mode 30, 59
 EG
 -Attack Time 72
 -Decay Time 72
 -Release Time 72
 Enhancer 67
 Ensemble Hall 64
 Exciter 67
 Exclusive Channel 18, 77, 86
 Exclusive Group 57
 Expression 17, 71, 87

F
 Factory preset 36, 79
 Filter 28
 Fine Tune 47
 Instrument 57
 Part 75
 Timbre 43
 Flanger 66
 Flanger-Delay 68
 Fx (Effect) 27, 55

G

Global mode 34, 76
 GLOBAL-CONTROL 77
 GLOBAL-MASTER 76
 GM System On 30, 32, 34, 79, 89
 GS Reset 32, 79, 94

H

Hall 64
 HARDWARE 76
 Harmonic Chorus 66

I

IBM PC (compatible) 7
 Initialize 79
 Inquiry Message 89
 Installing into a rack 6
 Instrument 31, 57
 Intensity
 Aftertouch Pitch LFO- 48
 Color- 50
 Effect Dynamic Modulation- 60
 Modulation Wheel Pitch LFO- 48
 Pitch EG- 49
 Pitch EG Velocity Sensitivity 49
 Pitch LFO- 48
 VDA Keyboard Tracking- 53
 VDA LFO- 53
 VDF EG- 52
 VDF EG Velocity Sensitivity 52
 VDF Keyboard Tracking- 50
 VDF LFO- 51

K

Key Shift 17, 71
 Key Transpose 47
 Keyboard Tracking 29, 50, 53
 KNOB-ASSIGN 40
 Korg MIDI Driver 82
 Macintosh 84
 Windows 3.1 83
 Windows 95 82

L

Large Room 64
 LATCH/K.SYNC 15, 41
 Layered 25
 LCD
 Backlight 78
 -Contrast 76
 LFO Rate 74
 Live Stage 64
 Low Pass Filters 28
 Lower Part 22
 -Number 39
 LPF 28

M

Macintosh 8
 Master Balance 39, 89
 Master Key Shift 76
 Master Tune 76
 Master Volume 39, 89

MDrm 75
 MIDI channel 7, 17, 86
 MIDI Channel To Port 78
 MIDI File Translator 85
 MIDI Filter 78, 90
 MIDI keyboard 7
 MIDI TO PORT 78
 MOD 2 14
 Mod.2 73
 Mod.3 73
 Mode 20
 Modulation Wheel
 -Pitch LFO Intensity 48
 -Pitch LFO Speed 48
 -VDF 56
 MODWHL 73
 MONO DELAY/MODULATED DELAY 69
 Mono/Poly
 Part 75
 Program sound 55
 Multi mode 17, 32, 71
 Multisample 27
 -Select 47
 Multi-Tap Delay 65

N

NO EFFECT 64
 Note
 off 86
 on 86
 Note Window Bottom
 Part 75
 Timbre 44
 Note Window Top
 Part 75
 Timbre 44
 NRPN 88

O

OCTAVE 15
 Octave Select 47
 OSC (Oscillator) 26, 46
 Oscillator 28
 -Level 47
 -Mode 46
 -Panpot 55
 Overdrive 67

P

PAf 73
 PANPOT 14
 Panpot 17, 87
 Instrument 57
 Oscillator- 55
 Part 71
 Timbre 43
 Panpot/Output Level 60
 PARA.1 (Parallel 1) 30, 59
 PARA.2 (Parallel 2) 30, 59
 PARA.3 (Parallel 3) 30, 59
 PARA.S (Parallel sub) 30, 59
 Parallel
 -1 placement 59
 -2 placement 59

-3 placement 59
 Connected effects 30
 -sub placement 59
 Parametric EQ 68
 Part 17, 38
 Common 21
 -Edit 72
 -Mode 75
 Parameter 21
 PART EDIT 72
 Part Edit mode 34, 72
 PART EG 72
 PART FILT/WIN 75
 PART Mod 73
 PART OTHERS 75
 PART SCALE TUNE 73
 PC Exchange 85
 PC Interface To Port 77, 95
 Performance 12, 21, 86
 List 91
 -Number 12, 18
 -Octave 39
 -Select 18, 38
 Performance Edit mode 22, 39
 Performance Play mode 12, 21, 38
 PERFORM-COMMON 39
 Pitch Bend 87
 -Range 16, 73, 88
 PITCH EG 49
 Pitch EG 26
 -Attack Level 49
 -Attack Time 49, 73
 -Decay Time 49
 -Intensity 49
 -Intensity Velocity Sensitivity 49
 -Release Level 49, 73
 -Release Time 49, 73
 -Start Level 49, 73
 -Time Velocity Sensitivity 49
 PITCH LFO 48
 Pitch LFO 26
 -Delay 48
 -Depth 74
 -Fade-in Time 48
 -Frequency 48
 -Intensity 48
 -Waveform 48
 Pitch Slope 47
 PORTA. TIME 14
 Portamento 13
 Portamento Switch
 Part 75
 Program sound 55
 Portamento Time
 Part 76
 Performance 13
 Program sound 55
 Positional crossfade 29
 Preset Drumkit 31
 PRESET/INIT 79
 PROG TO PORT 78
 Program
 -Change To Port 78
 -Edit 27, 46
 -Number 71

-Number Select 43
 -Rename 56
 -select 38
 -Sound 26, 86
 Program Edit mode 26, 46

Q
 Quadrature Chorus 65

R
 Realtime Controller 14
 Assign 22
 Receive
 -Aftertouch 44
 -Color 78
 -Control Change 44
 -Damper 44
 -MIDI channel 71
 -Note Off Switch 58
 -Note On 44
 -Note On Switch 58
 -Pitch Bend 44
 -Portamento 45
 -Switch 78
 Relative
 -Attack Time 58
 -C Send Level 58
 -Color 58
 -Cutoff 58
 -D Send Level 58
 -Decay Time 58
 RELEASE 14
 Release Time 87
 Rename 27, 35, 56
 Combination 45
 Effect- 61
 Program 56
 Reset All Controllers 89
 Resonance Filter 70
 REVERB 64
 Room 64
 Rotary Speaker 68
 RPN 88
 RX. SWITCH 78

S
 Save 35
 Combination sound 26
 Drumkit 32
 Effect 31
 Global mode 34
 Multi mode 33
 Part Edit mode 34
 Performance 23
 Program sound 29
 Scale (temperament) 90, 95
 Scale Tuning 73
 SERIALS (Serial sub) 30, 59
 SERIAL 30, 59
 Serial Interface Cable 8
 Serial Placement 59
 Serial Sub Placement 59
 serial-Connected Effects 30
 SINGLE 27, 46

Single Effects 30
 Single-channel
 -Layer 13
 -Layer/Split 13, 77
 -Split 13
 SMF 85
 Sort 15
 Sound Bank
 List 91
 Multi 17
 Performance 12
 SPEED 15
 Split 25
 Point 13, 22, 40
 Spring Reverb 64
 Stereo Delay 64
 Stereo Phaser 67
 Sustain pedal 86
 Symphonic Ensemble 66
 System exclusive 89

T
 Tonal quality changes over time 28
 Tone 87
 Transpose 16, 17
 Instrument 57
 Key- 47
 Timbre 43
 Transposing 88
 Tremolo 68
 Tuning 16, 76, 88
 TYPE 15

U
 Universal System Exclusive 89
 Upper Part 22
 -Number 39
 User drumkit 31

V
 VDA (Variable Digital Amplifier) 27, 53
 -Amplifier 74
 -Keyboard Tracking EG Time 53
 -Keyboard Tracking EG Time Switch & Polarity 53
 -Keyboard Tracking Intensity 53
 -Keyboard Tracking Key 53
 -Keyboard Tracking Mode 53
 -Section 28
 VDA EG 14, 27, 54
 -Amplitude Velocity Sensitivity 54
 -Attack Level 54
 -Attack Time 40, 54, 72
 -Break Point 54
 -Decay Time 40, 54, 72
 -Release Time 40, 54, 72
 -Slope Time 54
 -Sustain Level 54
 -Time Velocity Sensitivity 54
 -Time Velocity Sensitivity Switch & Polarity 54
 VDA LFO 27, 53
 -Delay 53
 -Depth 74
 -Fade-in Time 53
 -Frequency 53

-Intensity 53
 -Waveform 53
 VDF (Variable Digital Filter) 26, 50
 -Cutoff 40, 73
 -Cutoff Frequency 50
 -Keyboard Tracking EG Time 50
 -Keyboard Tracking EG Time Switch & Polarity 50
 -Keyboard Tracking Intensity 50
 -Keyboard Tracking Key 50
 -Keyboard Tracking Mode 50
 -Section 28
 VDF EG 27, 51
 -Attack Level 51
 -Attack Time 40, 51, 72
 -Break Point 51
 -Decay Time 51
 -Intensity 52
 -Intensity Velocity Sensitivity 52
 -Release Level 52
 -Release Time 40, 52, 72
 -Slope Time 51
 -Sustain Level 52
 -Time Velocity Sensitivity 52
 -Time Velocity Sensitivity Switch & Polarity 52
 VDF LFO 26, 51
 -Delay 51
 -Depth 74
 -Fade-in Time 51
 -Frequency 51
 -Intensity 51
 -Waveform 51
 Velocity Curve 77
 Velocity Sensitivity
 -Depth 76
 -Offset 76
 Velocity Switch 25
 Velocity Window Bottom
 Oscillator 47
 Part 75
 Timbre 44
 Velocity Window Top
 Oscillator 47
 Part 75
 Timbre 44
 Vibrato 28, 87
 Voice 33
 Voice Name List 96
 Volume 9, 17, 40, 71, 87
 Part 71
 Timbre 43
 Volume changes over time 28

W
 Wet Plate 64
 Write Protect 35, 78

X
 XG System On 32, 79, 93

DESC: OWNERS MANUAL N1R
QTY: 0001 SN:

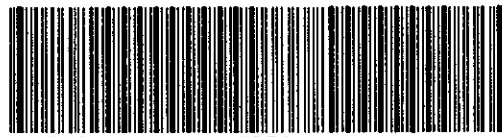

□OMN1R 0001 □

NOTICE

KORG products are manufactured under strict specifications and voltages required by each country. These products are warranted by the KORG distributor only in each country. Any KORG product not sold with a warranty card or carrying a serial number disqualifies the product sold from the manufacturer's/distributor's warranty and liability. This requirement is for your own protection and safety.

KORG KORG INC.

15 - 12, Shimotakaido 1 - chome, Suginami-ku, Tokyo, Japan.