

Model XM-2

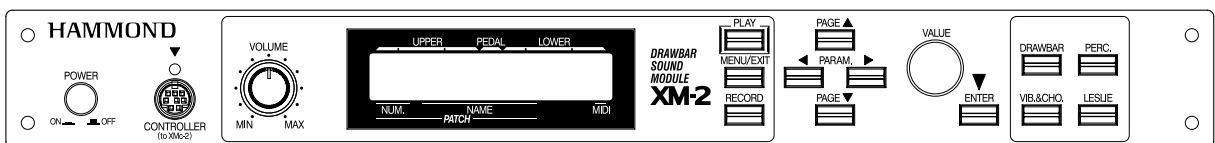

Thank you, and congratulations on your choice of a Hammond XM-2, Drawbar Sound Module. In order to get the most out of this instrument for many years to come, please take the time to read this manual in full.















Owner's Manual

IMPORTANT SAFETY INSTRUCTIONS

- ◆ Before using this unit, please carefully read this "Safety Instructions" and use it correctly.
- ◆ Please be sure to keep this manual at hand even after reading it once.
- ◆ This "Safety Instructions" section contains very important points for securing your safety. Strictly observe the instructions, please.
- ◆ In this manual, the degrees of dangers and damages are classified and explained as follows:

	WARNING This sign shows there is a risk of death or severe injury if this unit is not properly used as instructed.
	CAUTION This sign shows there is a risk of injury or material damage if this unit is not properly used as instructed. *Material damage here means a damage to the room, furniture or animals or pets.

WARNING

- ◆  Do not open (or modify in any way) the unit or its AC adaptor.
- ◆  Do not attempt to repair the unit, or replace parts in it (except when this manual provides specific instructions directing you to do so). Refer all servicing to your retailer, the nearest Hammond, or an authorized Hammond distributor, as listed on the "Service" page.
- ◆  Never use or store the unit in places that are:
 - ◆ Subject to temperature extremes (e.g., direct sunlight in an enclosed vehicle, near a heating duct, on top of heat-generating equipment)
 - ◆ Damp (e.g., baths, washrooms, on wet floors)
 - ◆ Humid
 - ◆ Exposed to rain
 - ◆ Dusty
 - ◆ Subject to high levels of vibration.
- ◆  Be sure to use only the AC adaptor supplied with the unit. Also, make sure the line voltage at the installation matches the input voltage specified on the AC adaptor's body. Other AC adaptors may use a different polarity, or be designed for a different voltage, so their use could result in damage, malfunction, or electric shock.
- ◆  Do not excessively twist or bend the power cord, nor place heavy objects on it. Doing so can damage the cord, producing severed elements and short circuits. Damaged cords are fire and shock hazards!
- ◆  This unit, either alone or in combination with an amplifier and headphones or speakers, may be capable of producing sound levels that could cause permanent hearing loss. Do not operate for a long period of time at a high volume level, or at a level that is uncomfortable. If you experience any hearing loss or ringing in the ears, you should immediately stop using the unit, and consult an audiologist.
- ◆  Do not allow any objects (e.g., flammable material, coins, pins); or liquids of any kind (water, soft drinks, etc.) to penetrate the unit.
- ◆  Immediately turn the power off, remove the AC adaptor from the outlet, and request servicing by your retailer, the nearest Hammond, or an authorized Hammond distributor, as listed on the "Service" page when:
 - ◆ The AC adaptor, the power-supply cord, or the plug has been damaged; or
 - ◆ If smoke or unusual odor occurs
 - ◆ Objects have fallen into, or liquid has been spilled onto the unit; or
 - ◆ The unit has been exposed to rain (or otherwise has become wet); or
 - ◆ The unit does not appear to operate normally or exhibits a marked change in performance.
- ◆  In households with small children, an adult should provide supervision until the child is capable of following all the rules essential for the safe operation of the unit.
- ◆  Protect the unit from strong impact. (Do not drop it!)
- ◆  Do not force the unit's power-supply cord to share an outlet with an unreasonable number of other devices. Be especially careful when using extension cords - the total power used by all devices you have connected to the extension cord's outlet must never exceed the power rating (watts/amperes) for the extension cord. Excessive loads can cause the insulation on the cord to heat up and eventually melt through.
- ◆  Before using the unit in a foreign country, consult with your retailer, the nearest Hammond, or an authorized Hammond distributor, as listed on the "Service" page.
- ◆  Do not put anything that contains water (e.g., flower vases) on this unit. Also, avoid the use of insecticides, perfumes, alcohol, nail polish, spray cans, etc., near the unit. Swiftly wipe away any liquid that spills on the unit using a dry, soft cloth.



CAUTION



- ◆ The unit and the AC adaptor should be located so their location or position does not interfere with their proper ventilation.



- ◆ Always grasp only the plug on the AC adaptor cord when plugging into, or unplugging from, an outlet or this unit.



- ◆ At regular intervals, you should unplug the AC adaptor and clean it by using a dry cloth to wipe all dust and other accumulations away from its prongs. Also, disconnect the power plug from the power outlet whenever the unit is to remain unused for an extended period of time. Any accumulation of dust between the power plug and the power outlet can result in poor insulation and lead to fire.



- ◆ Try to prevent cords and cables from becoming entangled. Also, all cords and cables should be placed so they are out of the reach of children.



- ◆ Never climb on top of, nor place heavy objects on the unit.



- ◆ Never handle the AC adaptor or its plugs with wet hands when plugging into, or unplugging from, an outlet of this unit.



- ◆ Before moving the unit, disconnect the AC adaptor and all cords coming from external devices.



- ◆ Before cleaning the unit, turn off the power and unplug the AC adaptor from the outlet.



- ◆ Whenever you suspect the possibility of lightning in your area, disconnect the AC adaptor from the outlet.



In case if in the future your instrument gets too old to play or malfunctions beyond repair, please observe the instructions of this mark, or, if any question, be sure to contact your dealer or your nearest town or municipal office for its proper disposal.

IMPORTANT - PLEASE READ

Power Supply

- ◆ Do not use this unit on the same power circuit with any device that will generate line noise (such as an electric motor or variable lighting system).
- ◆ The AC adaptor will begin to generate heat after long hours of consecutive use. This is normal, and is not a cause for concern.
- ◆ Before connecting this unit to other devices, turn off the power to all units. This will help prevent malfunctions and/or damage to speakers or other devices.

Placement

- ◆ Using the unit near power amplifiers (or other equipment containing large power transformers) may induce hum. To alleviate the problem, change the orientation of this unit; or move it farther away from the source of interference.
- ◆ This device may interfere with radio and television reception. Do not use this device in the vicinity of such receivers.
- ◆ Noise may be produced if wireless communications devices, such as cell phones, are operated in the vicinity of this unit. Such noise could occur when receiving or initiating a call, or while conversing. Should you experience such problems, you should relocate such wireless devices so they are at a greater distance from this unit, or switch them off.
- ◆ Do not expose the unit to direct sunlight, place it near devices that radiate heat, leave it inside an enclosed vehicle, or otherwise subject it to temperature extremes. Also, do not allow lighting devices that normally are used while their light source is very close to the unit (such as a piano light), or powerful spotlights to shine upon the same area of the unit for extended periods of time. Excessive heat can deform or discolor the unit.
- ◆ When moved from one location to another where the temperature and/or humidity is very different, water droplets (condensation) may form inside the unit. Damage or malfunction may result if you attempt to use the unit in this condition. Therefore, before using the unit, you must allow it to stand for several hours, until the condensation has completely evaporated.
- ◆ Do not allow rubber, vinyl, or similar materials to remain on the unit for long periods of time. Such objects can discolor or otherwise harmfully affect the finish
- ◆ Do not paste stickers, decals, or the like to this instrument. Peeling such matter off the instrument may damage the exterior finish.

Maintenance

- ◆ To clean the unit, use a dry, soft cloth; or one that is slightly dampened.
- ◆ To remove stubborn dirt off plastic parts, use a cloth impregnated with a mild, non-abrasive detergent. Afterwards, be sure to wipe the unit thoroughly with a soft, dry cloth. Try to wipe the entire surface using an equal amount of strength, moving the cloth along with the grain of the wood. Rubbing too hard in the same area can damage the finish.
- ◆ Never use benzine, thinners, alcohol or solvents of any kind, to avoid the possibility of discoloration and/or deformation.

Additional Precautions

- ◆ Please be aware that the contents of memory can be irretrievably lost as a result of a malfunction, or the improper operation of the unit. To protect yourself against the risk of losing important data, we recommend that you periodically save a backup copy of important data you have stored in the unit's memory in another MIDI device (e.g., a sequencer).
- ◆ Unfortunately, it may be impossible to restore the contents of data that was stored in another MIDI device (e.g., a sequencer) once it has been lost. Hammond assumes no liability concerning such loss of data.
- ◆ Use a reasonable amount of care when using the unit's buttons, sliders, or other controls; and when using its jacks and connectors. Rough handling can lead to malfunctions.
- ◆ When connecting / disconnecting all cables, grasp the connector itself - never pull on the cable. This way you will avoid causing shorts, or damage to the cable's internal elements.
- ◆ To avoid disturbing your neighbors, try to keep the unit's volume at reasonable levels. You may prefer to use headphones, so you do not need to be concerned about those around you (especially when it is late at night).
- ◆ When you need to transport the unit, package it in the box (including padding) that it came in, if possible. Otherwise, you will need to use equivalent packaging materials.

BATTERY BACK UP

Your XM-2 uses a battery-backed RAM to remember your changes to the Parameters. When the battery voltage becomes low, the Display will show:

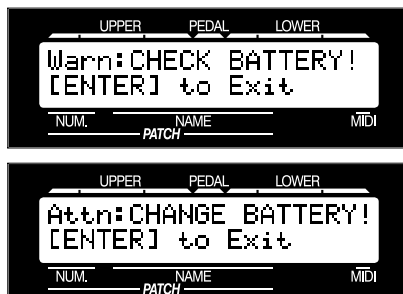

If you see these messages, you should immediately back up your parameter changes, if you have made any. If there is no battery installed in the unit, or if the battery is completely dead, the Display will show:



After the above message is displayed, the XM-2 will re-initialize itself, and the factory default settings will be restored. Therefore, it is a good idea to periodically save your data to a sequencer.

CAUTION: Ask your dealer or store for the details how to change the batteries.

Table Of Contents

IMPORTANT SAFETY INSTRUCTIONS	2
IMPORTANT - PLEASE READ	4
BATTERY BACK UP	5
MAIN FEATURES	9
NAMES AND FUNCTIONS	10
Front Panel	10
Rear Panel	11
HOOK-UP	13
BASIC HOOK-UP	14
CONNECTION USING A SIMPLE MIDI KEYBOARD	14
CONNECTION USING A SIMPLE MIDI KEYBOARD AND THE XMc-2	15
CONNECTION USING A MULTI-FUNCTIONAL MIDI KEYBOARD	16
CONNECTION USING TWO MIDI KEYBOARDS	16
CONNECTION USING MULTIPLE MIDI KEYBOARDS AND THE XMc-2 ..	17
CONNECTION OF LESLIE SPEAKER	18
BASIC CONNECTION OF THE LESLIE SPEAKER	18
MIDI CONTROL OF LESLIE SPEAKER	18
TURN ON AND PLAY	19
TURN ON THE POWER	20
HOW TO TURN THE POWER ON	20
BACK-UP	20
RESET TO THE FACTORY SETTINGS	20
LISTEN TO THE DEMONSTRATION	21
PLAY BY THE PATCH	22
HOW TO CALL OUT THE PATCHES	22
WHAT IS "PART" ?	22
PLAY WITH THE CONTROLLERS	23
PITCH BEND	23
EXPRESSION PEDAL	23
FOOT SWITCH	23
CREATE YOUR OWN SOUNDS	24
SELECT PATCH 128.	24
MAKE THE DRAWBAR REGISTRATION	24
ADD PERCUSSION	24
ADD EFFECTS	25
VIBRATO AND CHORUS	25
LESLIE	25
RECORD TO THE PATCH	26

SETTING UP	27
SOUND ENGINE STRUCTURE	28
SYSTEM STRUCTURE OF XM-2	28
HOW TO USE THE PANEL BUTTONS	30
EXAMPLE: Set Upper 8' of Drawbar registration at 5.	30
DRAWBAR (DRAWBAR registration)	31
DRAWBARS™	32
WHITE DRAWBARS	33
BLACK DRAWBARS	33
BROWN DRAWBARS	33
PEDAL DRAWBARS	33
DRAWBAR REGISTRATION PATTERNS	34
PERC (PERCUSSION)	36
NOTE	36
DRAWBAR CANCEL	36
VIB & CHO (VIBrato and CHORus)	37
LESLIE	38
PATCH	39
NAME THE PATCH	39
RECORD A NEW PATCH	40
DISPLAY AND ITS OPERATION	41
PLAY MODE	42
HOW TO READ THE DISPLAY	42
PANEL BUTTON MODE	43
HOW TO READ THE DISPLAY	43
BUTTON OPERATION IN THIS MODE	43
MENU MODE	44
HOW TO READ THE DISPLAY	44
BUTTON OPERATION IN THIS MENU	44
FUNCTION MODE	45
HOW TO READ THE DISPLAY	45
BUTTON OPERATION IN THIS MODE	45
EXAMPLE: Adjusting the DECAY TIME of the Percussion [FAST]	46
SHORT CUT TO THE FUNCTION MODE	48
EXAMPLE: Move to the Percussion Function Mode	48

SETTING THE PARAMETERS	49
DRAWBAR	50
◆ Setting the Manual (LOWER and UPPER)	50
◆ Setting the PEDAL	51
PATCH	52
◆ PATCH NAME	52
◆ PATCH LOAD	52
◆ PATCH NUMBERS	52
EFFECTIVE USE OF LINK-LOWER/PEDAL	53
WHEN LINK LOWER/PEDAL IS ON:	53
WHEN LINK LOWER/PEDAL IS OFF:	53
CONTROL	54
◆ PITCH BEND	54
◆ MODULATION	55
◆ PRESSURE	55
◆ EXPRESSION	56
◆ FOOT SWITCH	57
◆ DISPLAY	57
ADJUSTING THE EXPRESSION PEDAL	58
TUNE	59
CUSTOM TONEWHEELS	60
B-Type	60
Mellow	60
Brite	60
PERCUSS (PERCUSSION)	61
LESLIE	62
◆ CABINET NUMBERS	62
◆ LESLIE PARAMETERS	62
RECORD THE CABINETS	64
OD/VIB (OverDrive / VIBrato)	65
◆ OVERDRIVE	65
◆ VIBRATO & CHORUS	65
EQUALIZ (EQUALIZer)	66
REVERB	67
MIDI	68
◆ MIDI TEMPLATE	68
◆ MASTER	68
◆ MIDI CHANNEL	69
MIDI TEMPLATES AND THEIR PURPOSES	70
THE MIDI IN MODES AND THEIR FUNCTIONS	70
KEYMAP	71
◆ SPLIT	71
◆ MANUAL BASS	71
◆ WHAT IS SPLIT?	71
◆ WHAT IS MANUAL BASS?	71
DEFAULT	72
SYSTEM	73

APPENDIX	75
Part and MIDI Messages	77
MIDI Information	78
Drawbar Data List 1	79
Drawbar Data List 2	79
System Exclusive Message	80
Global Parameters	81
Patch Parameters	82
Leslie Parameters	84
System Parameters	84
Specifications	86
Demonstration Songs and Composers	87
Factory Patches	88
SERVICE	89

IN THIS MANUAL:

NOTE:s and **tips** appear frequently.

The **NOTE**: is a supplementary explanation.

The **tips** are explanations of terms and applications.

◆ **ACCURATELY REPRODUCES THE TONE-WHEEL SOUND.**

Your new XM-2 contains (96) independent oscillating digital tone-wheels which accurately reproduces the sound of the Vintage B-3.

In addition, this module has full polyphony.

◆ **DIGITAL LESLIE / VIBRATO EFFECTS.**

The XM-2 module is equipped with a DSP effect generator to simulate the Scanner-Vibrato and the Leslie Speaker.

The range of sounds that you can create is expanded by the use of Vibrato and Chorus effects, and by the real sounding Leslie effects which effectively simulates the rotation of the two Rotors which are present in a traditional Leslie.

◆ **8-PIN LESLIE SPEAKER SOCKET.**

Your new XM-2 contains an 8-pin Leslie speaker socket for direct connection to our Leslie 21 System Speakers.

◆ **CAN BE EXPANDED BY USE OF EXTERNAL MIDI PRODUCTS.**

You can connect your XM-2 with various MIDI instruments and expand its function. You can not only play it using a single MIDI keyboard but also expand the number of keyboards (Lower Keyboard and Pedal Keyboard) by connecting it with other MIDI keyboards. You can also record your performance to an external sequencer.

Front Panel

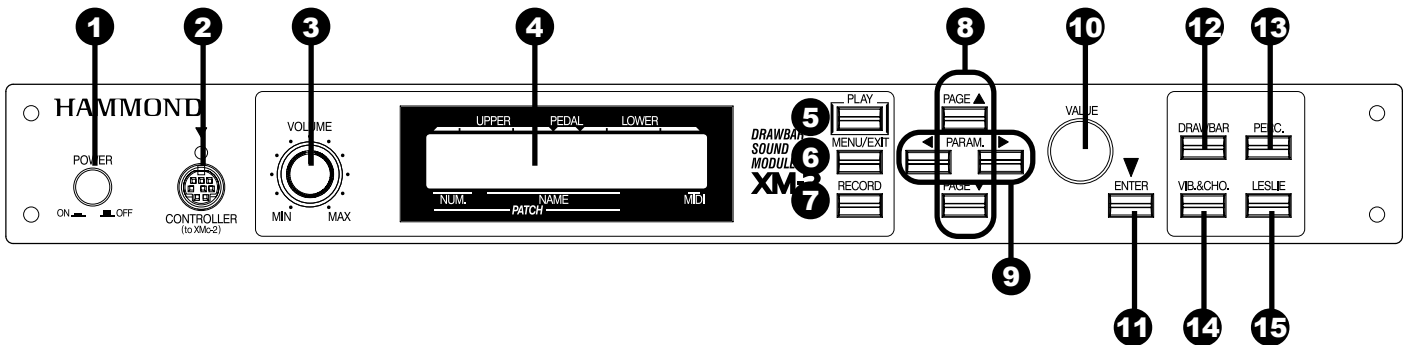

◆FRONT LEFT SIDE

1. POWER Switch

This switches ON/OFF the module.

2. CONTROLLER Jack

This is the terminal for connecting the Drawbar Controller XMc-2 (to be separately purchased).

Use the exclusive cable HMC-1 for connection.

3. VOLUME Knob

Controls the total volume.

4. DISPLAY

Displays various information.

◆EDIT BUTTONS

5. PLAY Button

Jumps to the PLAY mode, the basic mode.

6. MENU/EXIT Button

Recalls the MENU mode. This is also used to return from each function mode.

7. RECORD Button

Records the Patches.

This is also used for controlling the other recording.

8. PAGE Buttons

Selects Pages in the menu.

9. PARAMETER Buttons

Selects Parameters.

10. VALUE Knob

Increases and decreases the Patch or value of the selected parameter.

11. ENTER Button

This is used for deciding the selected items.

◆PANEL BUTTONS

12. DRAWBAR Button

Calls out the Drawbar Registration mode.

13. PERC. Button

Calls out the Percussion Switch mode.

14. VIB. & CHO. Button

Calls out the Vibrato Switch mode.

14. LESLIE Button

Calls out the Leslie Switch mode.

Rear Panel

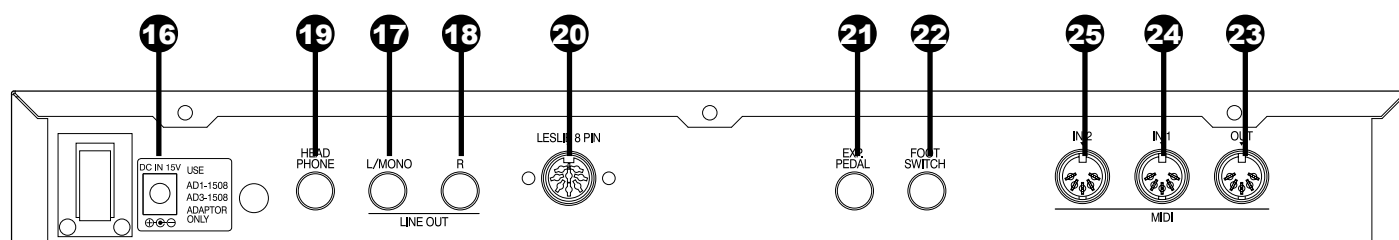

◆ POWER SUPPLY

16. DC IN Jack

Connects the attached AC Adaptor AD1-1508 (100 - 120V) AD3-1508 (220 - 240V).

◆ SOUND OUTPUT TERMINAL

17. LINE OUT L/MONO Jack

If your amplifier has only a single (1) female 1/4" audio input connector (MONO input), use this Jack.

18. LINE OUT R Jack

This is the Right channel output of the XM-2.
Use the Left and Right output Jacks if your mixer or amplifier has stereo inputs.
Use only the L/MONO terminal, if the input is monaural.
The built-in Leslie Effect is only on L (the left), when the Leslie Speaker (20) is connected.

19. HEADPHONE Jack

This is for connecting a set of stereo headphones.
Sound is sent out from the LINE-OUTS (17, 18) and LESLIE 8PIN (20), also when this terminal is used.
The built-in LESLIE is only on L (the left), when the LESLIE SPEAKER (20) is connected.

20. LESLIE 8PIN Jack

This is for connecting the Leslie 21 System Speaker.
Read "CONNECTING THE LESLIE SPEAKER" for more details.

◆ CONTROLLER TERMINAL

21. EXP. PEDAL Jack

This terminal is for the Expression Pedal (V-20R - optional).
You can control the volume while you play.

22. FOOT SWITCH Jack

This terminal is for the Foot Switch (FS-9H - optional).
You can switch the speed of the Leslie effect and the Patch, etc. while playing.

◆ MIDI

23. MIDI OUT Jack

Outputs the internal information of this unit and the playing information from the MIDI IN terminal (according to the setting).

24. MIDI IN 1 Jack

Receives the MIDI information.
The factory setting of this terminal is for receiving the information through the MIDI channel.
You can also set it for receiving only a specified part information, regardless of the channel.

25. MIDI IN 2 Jack

Receives the MIDI information.
The factory setting of this terminal is for receiving the information through the MIDI channel.
You can also set it for receiving only a specified part information, regardless of the channel.

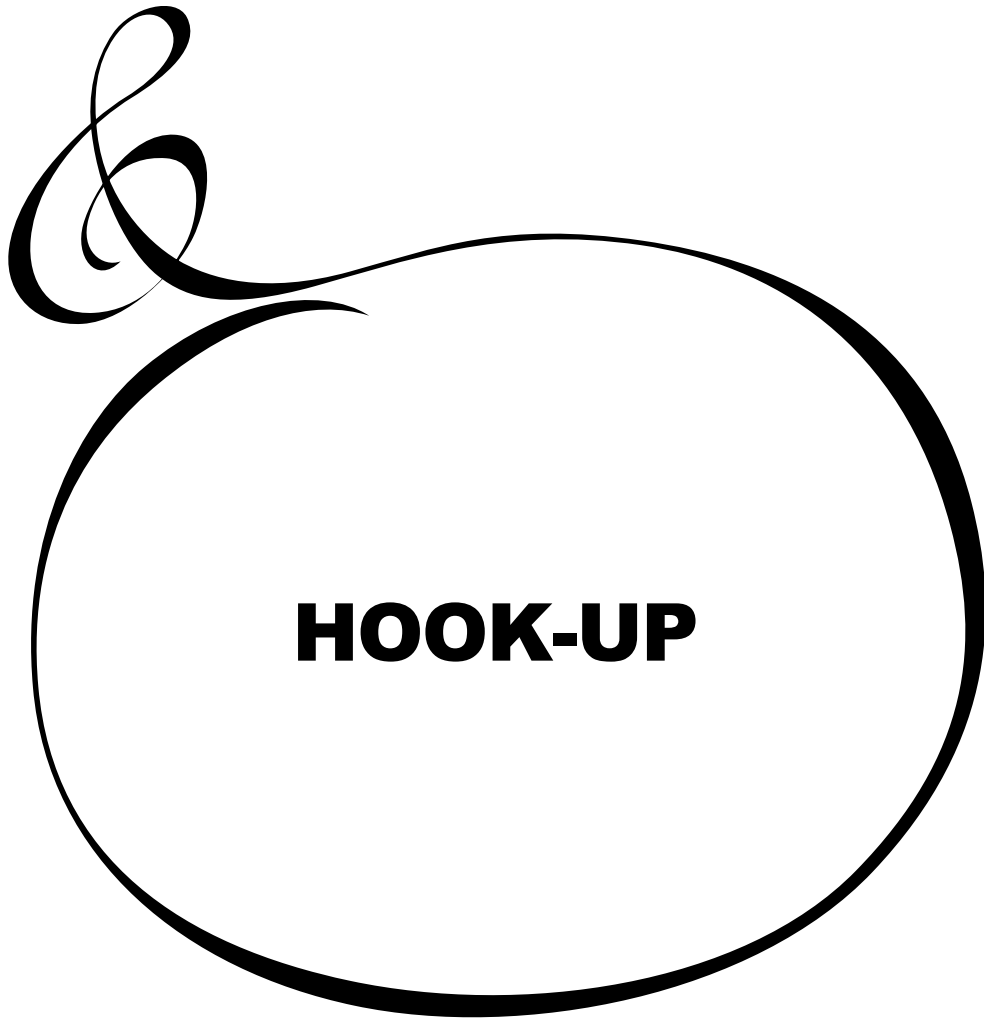

BASIC HOOK-UP

Be sure to turn OFF the power of your XM-2 and connecting devices before you do the hookup.

CONNECTION USING A SIMPLE MIDI KEYBOARD

This is the simplest example.

You can play as many as 3 parts by a single-manual MIDI Keyboard, using the Split and Manual Bass functions of the XM-2.

Set the MIDI Keyboard for sending a single channel. (The channel number does not matter.)

Call out "Single KBD" by the MIDI Template (P. 68) of this unit.

In this case of connection, you can record to and play out of an external sequencer.

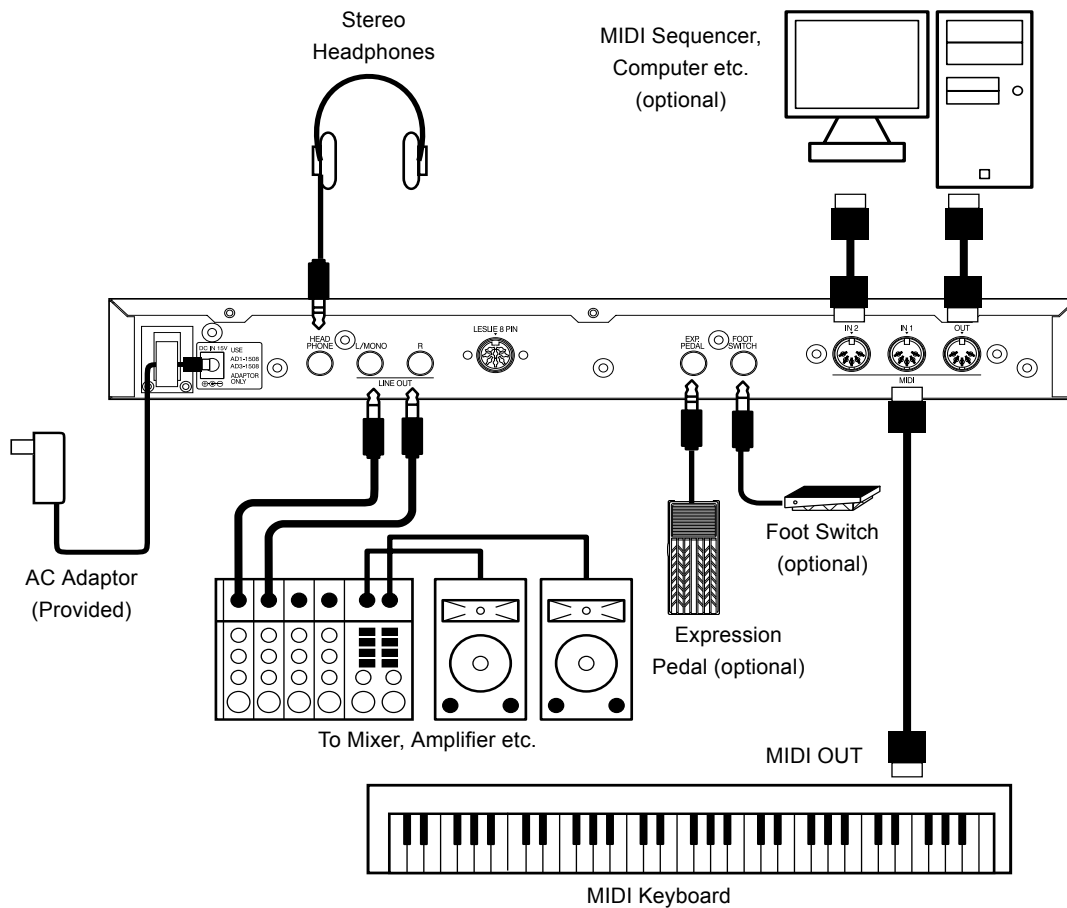

CONNECTION USING A SIMPLE MIDI KEYBOARD AND THE XMc-2

The hook-up example shown below is for making the Drawbar Registration change at hand using the Drawbar Controller XMc-2.

Set the MIDI Keyboard for sending a single channel. (The channel number does not matter.)

Call out “Single KBD” by the MIDI Template (P. 68) of this unit.

In this case of connection, you can record to and play out of an external sequencer.

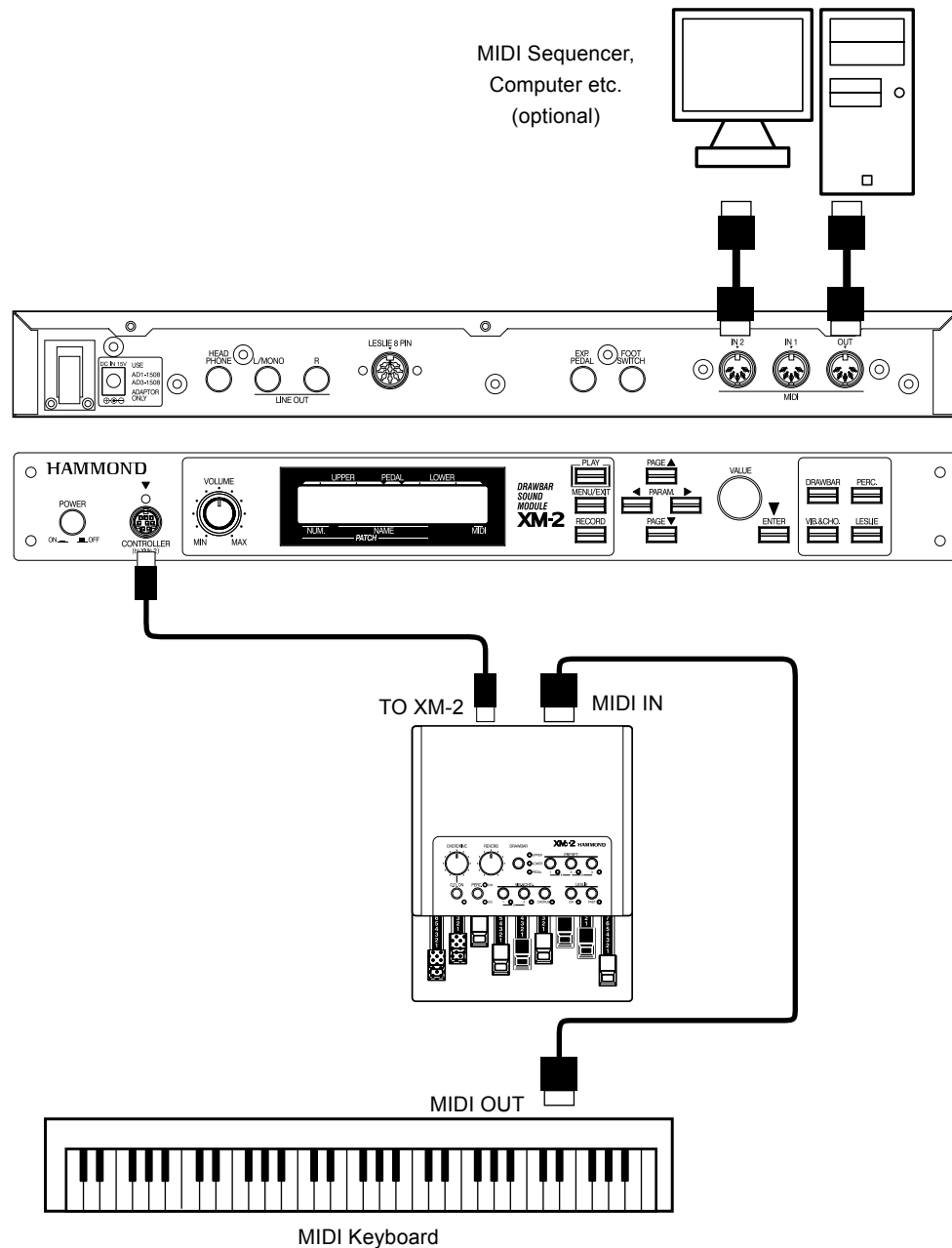

CONNECTION USING A MULTI-FUNCTIONAL MIDI KEYBOARD

This hook-up shown below is for using a MIDI Keyboard that can send data to multiple MIDI channels or an electronic organ that has multiple keyboards.

Call out “By Channel” by the MIDI template (P. 68) of this unit.

Set appropriate values for the MIDI channels on this unit and on each keyboard. The default settings of the receiving channels on this unit are Upper = 1, Lower = 2, and Pedal = 3.

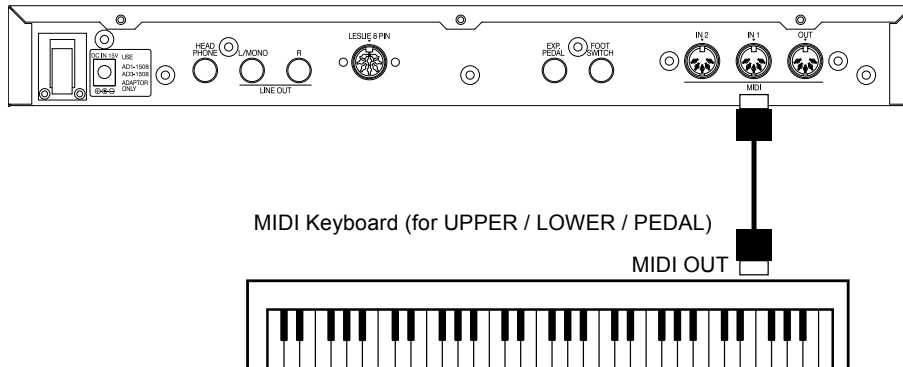

CONNECTION USING TWO MIDI KEYBOARDS

This hook-up example is for using two MIDI Keyboards; one for playing UPPER and the other for playing LOWER part.

Set each of the MIDI Keyboard to send a single channel. (The channel numbers do not matter.)

Call out “2KBD for L&U” by the MIDI Template (P. 68) of this unit.

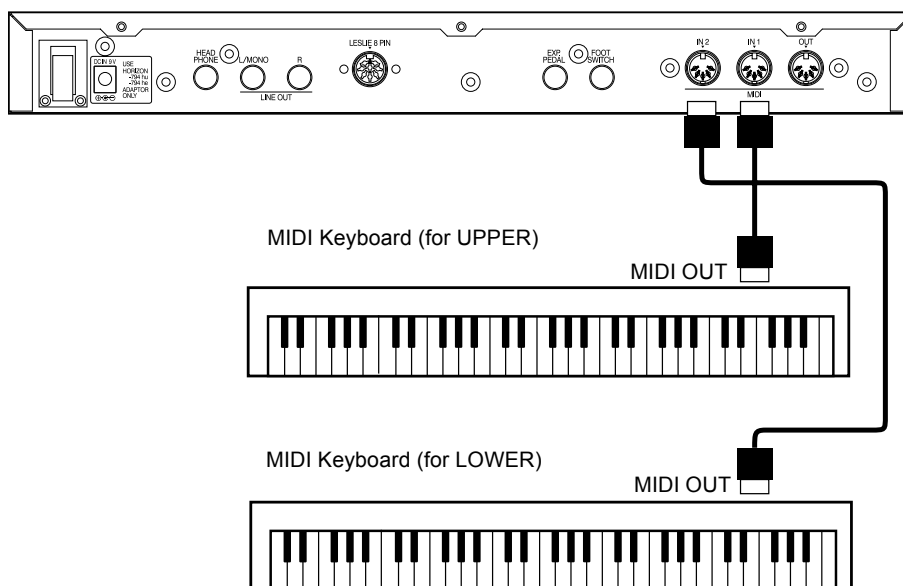

CONNECTION USING MULTIPLE MIDI KEYBOARDS AND THE XM_c-2

Using the Drawbar Controller XM_c-2 allows you not only to change the Drawbar Registration at hand, but also to easily build the double or triple manual systems using the built-in MIDI IN terminal of the XM_c-2.

Set each MIDI Keyboard to send a single channel. (The channel number does not matter.)

Call out “2/3KBD via XM_c” by the MIDI Template (P. 68) of this unit.

This example of connection allows you to record into an external sequencer.

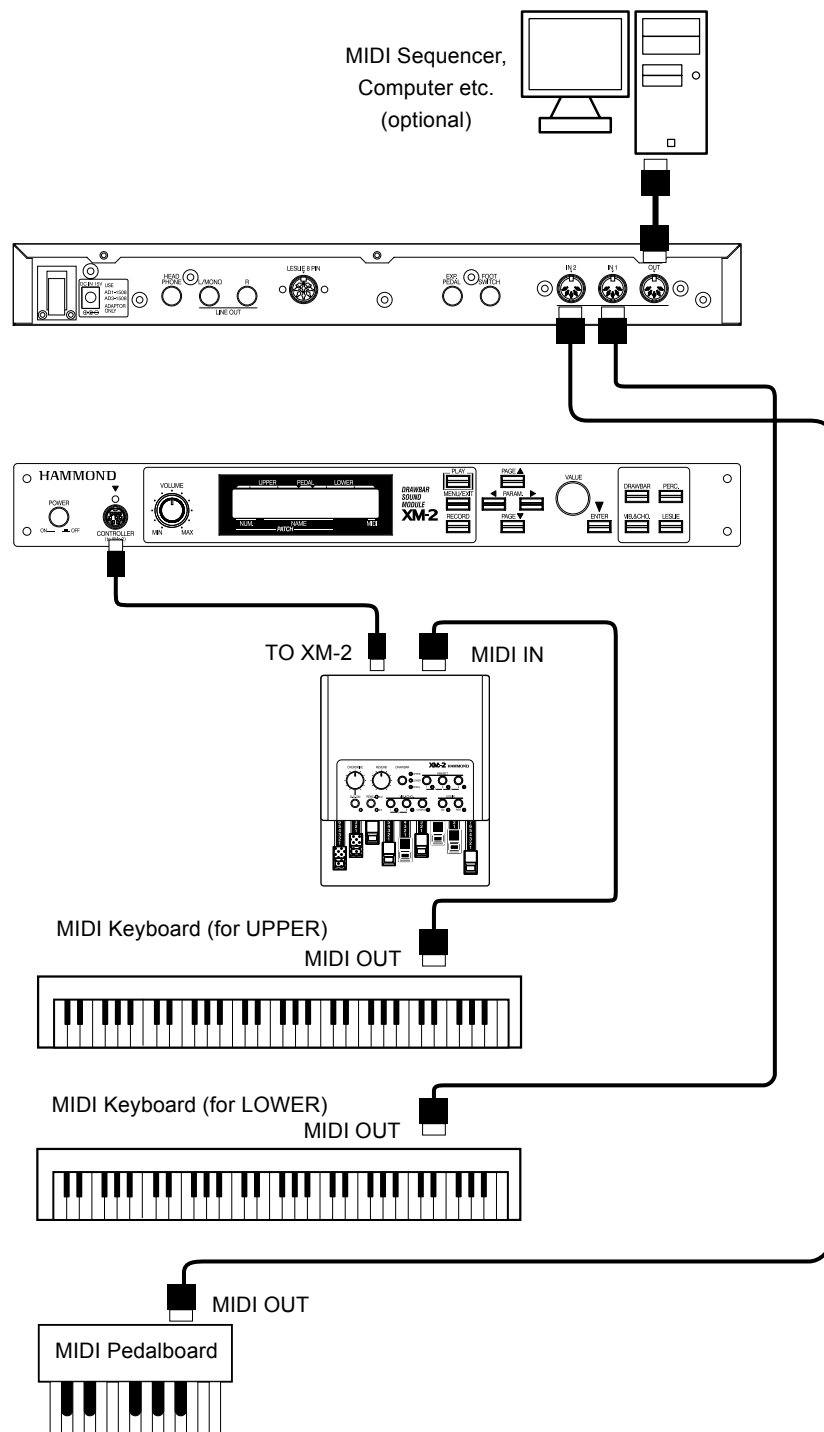

CONNECTION OF LESLIE SPEAKER

This unit has an 8-pin Leslie Connector which can directly connect the Leslie Speaker.

Be sure to turn OFF the power before you connect to the Leslie Speaker.

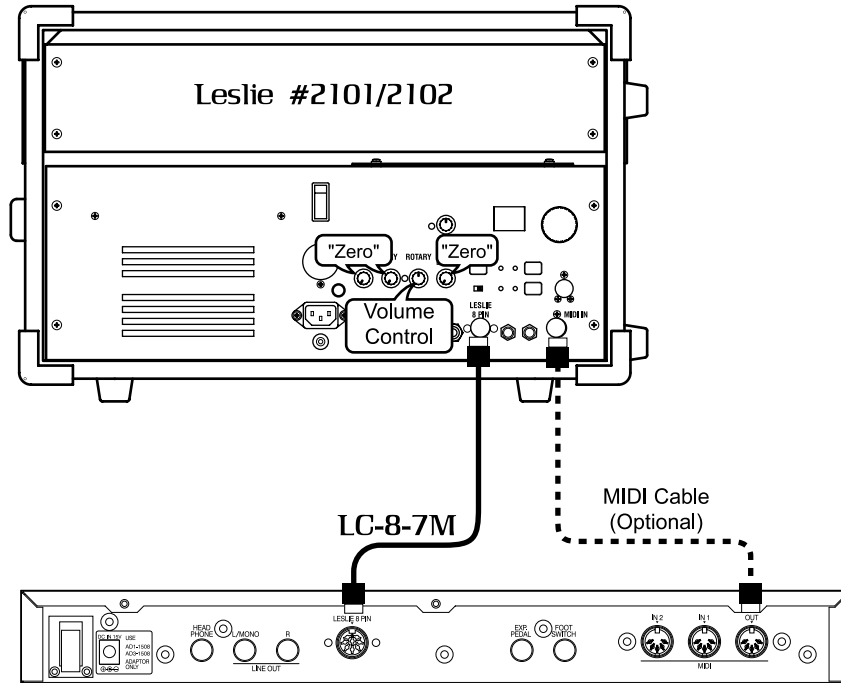

BASIC CONNECTION OF THE LESLIE SPEAKER

Connect the Leslie Speakers #2101, 2102 and the Leslie 8-pin terminal by use of the exclusive 8-pin Leslie Cable LC-7-8M(= optional, to be separately purchased).

NOTE: The Leslie terminal on this unit has 8 pins. For connecting a 11-pin Leslie Speakers, you need a Leslie Adaptor XLD-811 (= optional, to be separately purchased).

The volume of the Leslie Speakers #2101, 2102 is adjusted by the Rotary knob. Set the Stationary knob at Minimum. The sound circuit on this unit is specified for a single channel.

Refer to the Leslie Speaker manual as well to make sure.

MIDI CONTROL OF LESLIE SPEAKER

For MIDI-controlling the parameters (=fine adjustment of the Rotary speed, rise time, etc.) on the Leslie #2101, 2102:

1. Connect the MIDI OUT of this unit and the MIDI IN on the Leslie Speaker by the MIDI cable.
2. Set the MIDI channel - UPPER of this unit and the MIDI channel of the Leslie Speaker to the same channel. (P. 69 #11)
3. Set the MIDI - Leslie Parameter of this unit at "21". (P. 69 #8)

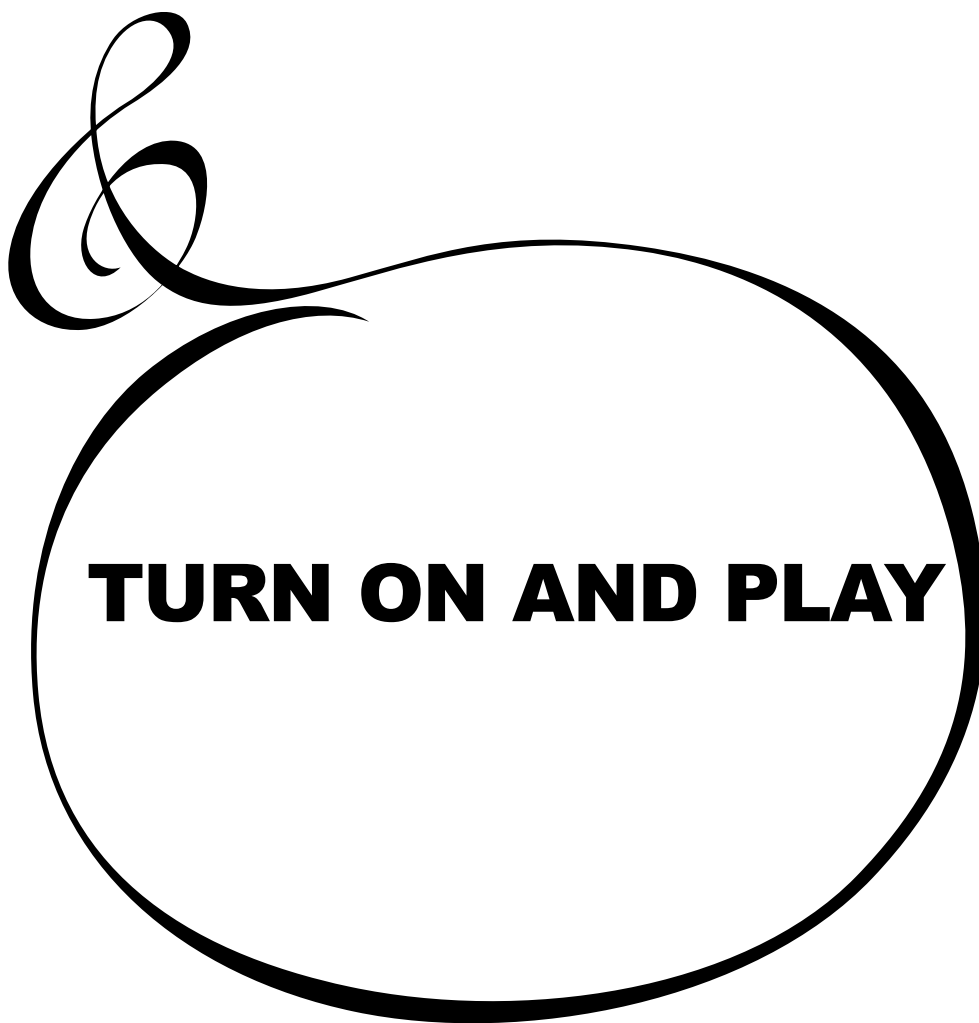

HOW TO TURN THE POWER ON

After the connection is completed, turn on the power in the following order: If you do not follow this order, it may cause malfunctions or damages to the speakers etc.

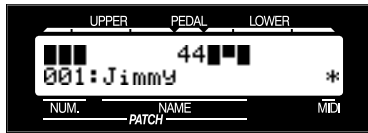
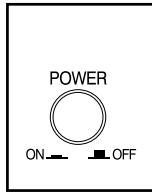
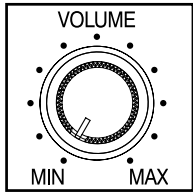

STEPS TO TAKE

1. Before turning the unit ON, make sure that the [VOLUME] knob of this unit is at MIN.
2. Turn the [POWER] switch ON. In the display, the title and then the PLAY mode appears. (See the illustration.)
 - ❖ *It does not immediately start up after turning the power on because of circuit protection.*
3. Turn on the power of the connected amplifier etc.
4. Turn the [VOLUME] knob for fine adjustment.
5. Adjust the volume of the amplifier etc.

You can adjust the volume more easily if you use the demonstration play.

- ❖ *When you turn off the power, do the above procedure backwards. Turn OFF the amplifier etc. first.*

BACK-UP

This unit memorizes the status of the settings immediately before it is turned off. For this reason, the settings when the unit is powered up is the same as they were just before the unit was shut off. This is called BACK-UP.

RESET TO THE FACTORY SETTINGS

To return all settings on this unit to the original Factory Settings, do the following:

STEPS TO TAKE

1. Turn OFF the power on this unit.
2. Turn the power ON, holding down the [RECORD] button.
3. Keep pressing the [RECORD] button until "Loading Default" appears in the display.
4. The procedure is completed when the PLAY mode appears.

Demonstration Plays are built in for introducing the features, sounds, etc. of this unit.

STEPS

1

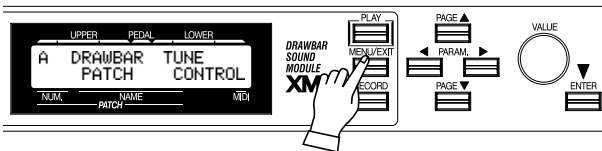

Touch the [MENU/EXIT] button and display the menu.

2

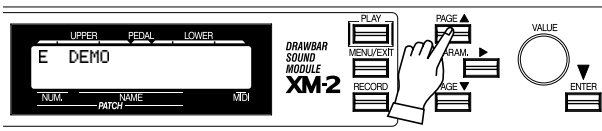

Touch the [PAGE] button and go to Page E.

3

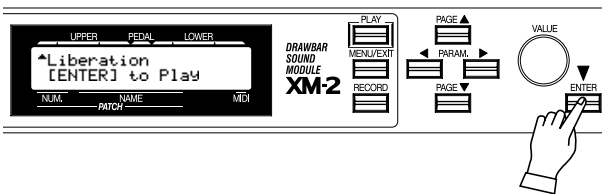

Touch the [ENTER] button.
The Demo mode appears.

4

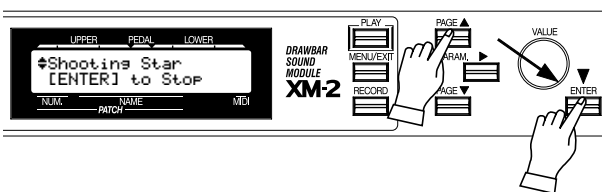

Select the tune you want to listen to by touching the [PAGE] button.

The play starts when you touch the [ENTER] button.

NOTE: When the tune ends, the next one automatically starts.

For selecting another tune while playing, touch the [ENTER] button again. (The play stops.)

5

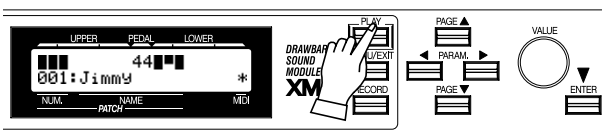

To stop the Demo Play, touch either the [MENU/EXIT] or [PLAY] button.

NOTE: Demo Plays do not affect the existing settings.

This unit memorizes various settings up to 128 [PATCHES]. For your immediate play after purchasing this unit, the factory settings are recorded in the patches 001 to 120.

HOW TO CALL OUT THE PATCHES

EXAMPLE: Select 041.

①

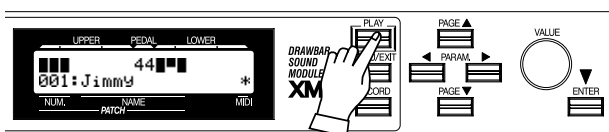

GO TO THE PLAY MODE

If the present mode is not PLAY, touch [PLAY] and go to the PLAY mode.

②

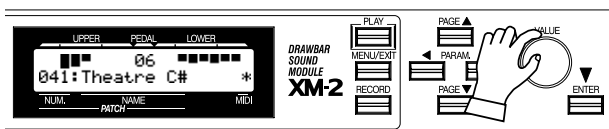

SELECT THE PATCH NUMBER

Select Patch No. 041 by the [VALUE] knob.

Call out various patches and play.

When you call out a patch, not only does the Drawbar registration of each part change but also the effects such as Leslie and Reverb also change.

NOTE: You can set the type of parameter you call out. (P. 52 #2 to 8)

WHAT IS "PART" ?

A [PART] is like a player in a band or in an orchestra.

Like an organ with 3 manuals can produce 3 different sounds, this unit also can produce 3 different parts, Upper, Lower, and Pedal, because it has these 3 different parts.

NOTE: The function that makes it possible to use multiple sounds is called [Multi-Timbre].

You can play more expressively if you operate the controller while playing. Let us explain in this page about the controller generally used in electronic musical instruments. (About the unique HAMMOND Controller, let us explain in the next page.)

PITCH BEND

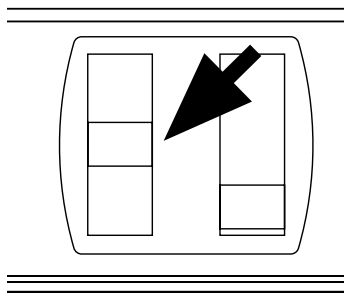

This figure shows an example: XK-1.

You can change the pitch while playing, by receiving the Pitch Bend information.

NOTE: You can adjust the amount of the pitch change by the Pitch Bend information. (P. 54 #1 to 4)

EXPRESSION PEDAL

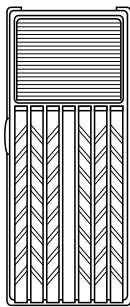

This figure shows V-20R (= optional, to be separately purchased).

On an organ, generally not like on the piano, the velocity, i.e. touch on the keys, does not give any dynamics.

However, if you connect an expression pedal (= optional) to this unit, or receive the expression information from the MIDI, you can change the volume and give expression to your play.

The volume of the Expression Pedal gets maximum when fully depressed on the toe-side and gets minimum when fully returned on the heel-side.

NOTE: Set this unit to match the model of your expression pedal. (P. 56 #13)

FOOT SWITCH



This figure shows FS-9H (= optional, to be separately purchased).

This is used for controlling various switches by foot instead of doing it by hand. In the default settings, “Leslie Fast” is assigned here.

NOTE: You can change the assignment of the foot switch. (P. 57 #19 to 20)

Let us here explain how to create the unique HAMMOND sounds such as Drawbars, Percussion sounds and the sounds obtained by using the Vibrato or Leslie effects. The example here is after a MIDI Keyboard (set for MIDI Channel 1) is connected to the MIDI IN 1 terminal of this unit (immediately after delivery from your dealer).

SELECT PATCH 128.

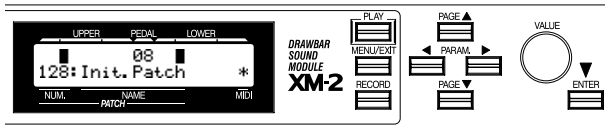

Call out Patch Number 128. The default setting of this Patch is the simplest of all, so it is best suited for creating new sounds.

MAKE THE DRAWBAR REGISTRATION

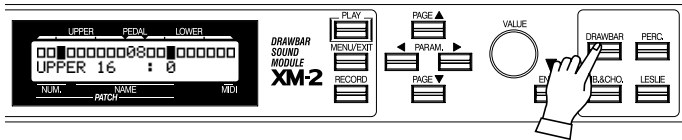

Touch the [DRAWBAR] button. The display turns into the Drawbar Registration (how far the bars are drawn) mode.

In this mode, the basic sounds using the Drawbars are created.

Adjust the volume of each footage in the range of the displayed "UPPER", while touching the keys.

The volume gets loud when the value of each footage (each digit of Drawbar Registration) increases. It gets quieter when the value gets smaller. Basically, the pitch gets higher from left to right.

Select the footage by the [PARAM] button, and change the value by the [VALUE] knob. Operate the other parameters in the same way.

The most frequently used registrations are 3 fully drawn left-side bars and all 9 fully drawn bars.

NOTE: You can change the characters of the Drawbars. (P. 50)

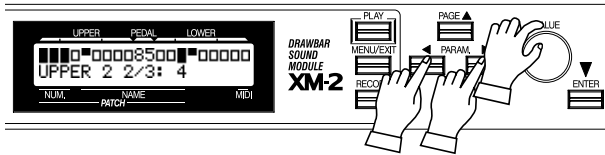

ADD PERCUSSION

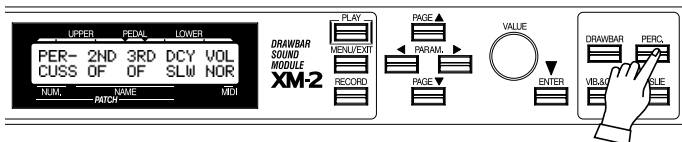

The "Percussion" here is not the ordinary percussion instrument but that of decaying sounds that adds lively and articulate sounds. Mix the sounds with the Drawbar sounds whenever you want.

Touch the [PERC] button. The display turns into the PERCUSSION mode.

Turn ON and OFF each value of "2ND" and "3RD" of the parameter by the [PARAM] button and the [VALUE] knob. The decay sounds of an octave higher "DO" (the second harmonics) and "SO" (the third harmonics) are added to the note on the keyboard.

The decay speed gets faster if you change "DCY" from SLW to FST. The Percussion volume goes down if you change "VOL" from NOR to SFT.

NOTE: You can fine-adjust the percussion volume etc. (P. 61)

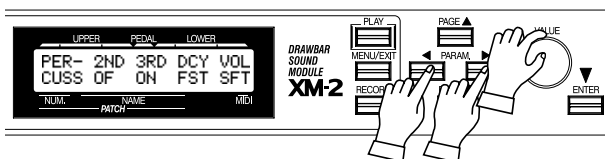

ADD EFFECTS

VIBRATO AND CHORUS

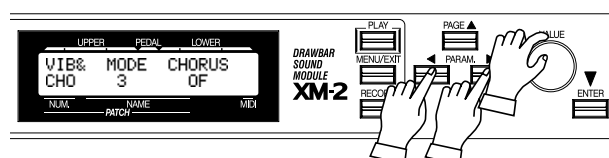
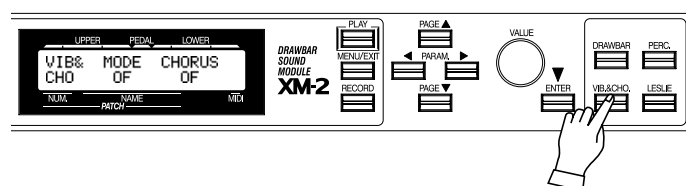

Warmth can be added to the sound by slightly changing the Drawbar pitch in a certain cycle.

Touch the [VIB&CHO] button. The display changes to Vibrato and Chorus mode.

“MODE”

This sets the depth of the Vibrato effect. At OF no effect is added. As the value gets larger from 1 to 3, the effect gets deeper.

“CHORUS”

Vibrato sound is mixed to the original tone, and thickness is added to the sound when you turn this on.

LESLIE

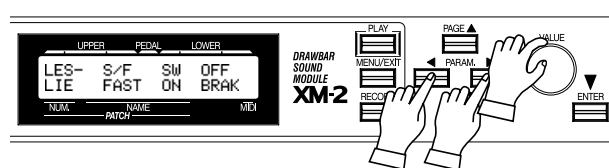
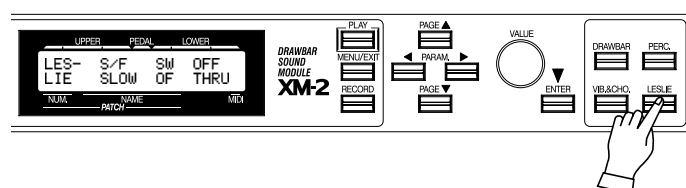

This gives the effects of a live performance feelings by the feeling of turning rotors.

Touch the [LESLIE] button. The display changes to the Leslie mode.

“SW”

Turn this ON to get the Leslie effects.

“S/F”

This switches the Rotor speed to SLOW or FAST (2 steps). The most popular style is to play at SLOW basically and then to change to FAST only at the climax.

“OFF”

This sets the action when the value of the parameter “SW” of the Leslie effect is OF. BRAK stands for Brake. (The Rotor gradually slows down and then finally stops.) THRU stands for Through. (The Leslie effect is bypassed.)

NOTE: These parameters are used for controlling, in the case Leslie speakers are connected externally.

NOTE: Fine settings are possible for the turning speed of the built-in Leslie effects etc.

In this chapter we have explained the settings you can make from the panel buttons. Let us explain in the next page about the Overdrive and Reverb; elements for creating the HAMMOND ORGAN sounds.

RECORD TO THE PATCH

The settings you have made so far can be recorded or memorized to your desired Patches.

You can also freely rewrite the built-in Patches when delivered from the factory.

EXAMPLE: RECORD INTO "011"

1

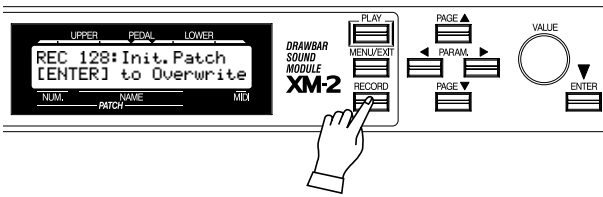

Touch the [RECORD] button. The Record mode appears.

2

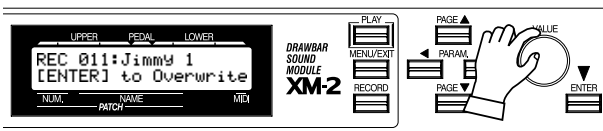

Select the Patch Number (011 in this example) to record to by the [VALUE] knob.

3

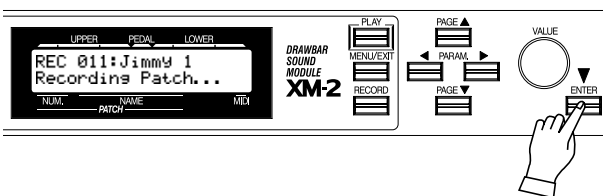

Touch the [ENTER] button. The Patch is decided and the following is displayed in the mode for certain seconds:

Recording Patch...

When the recording is completed, the display returns to the immediate previous mode.

NOTE: The recorded Patch data are not lost even after the power is turned off.



SYSTEM STRUCTURE OF XM-2

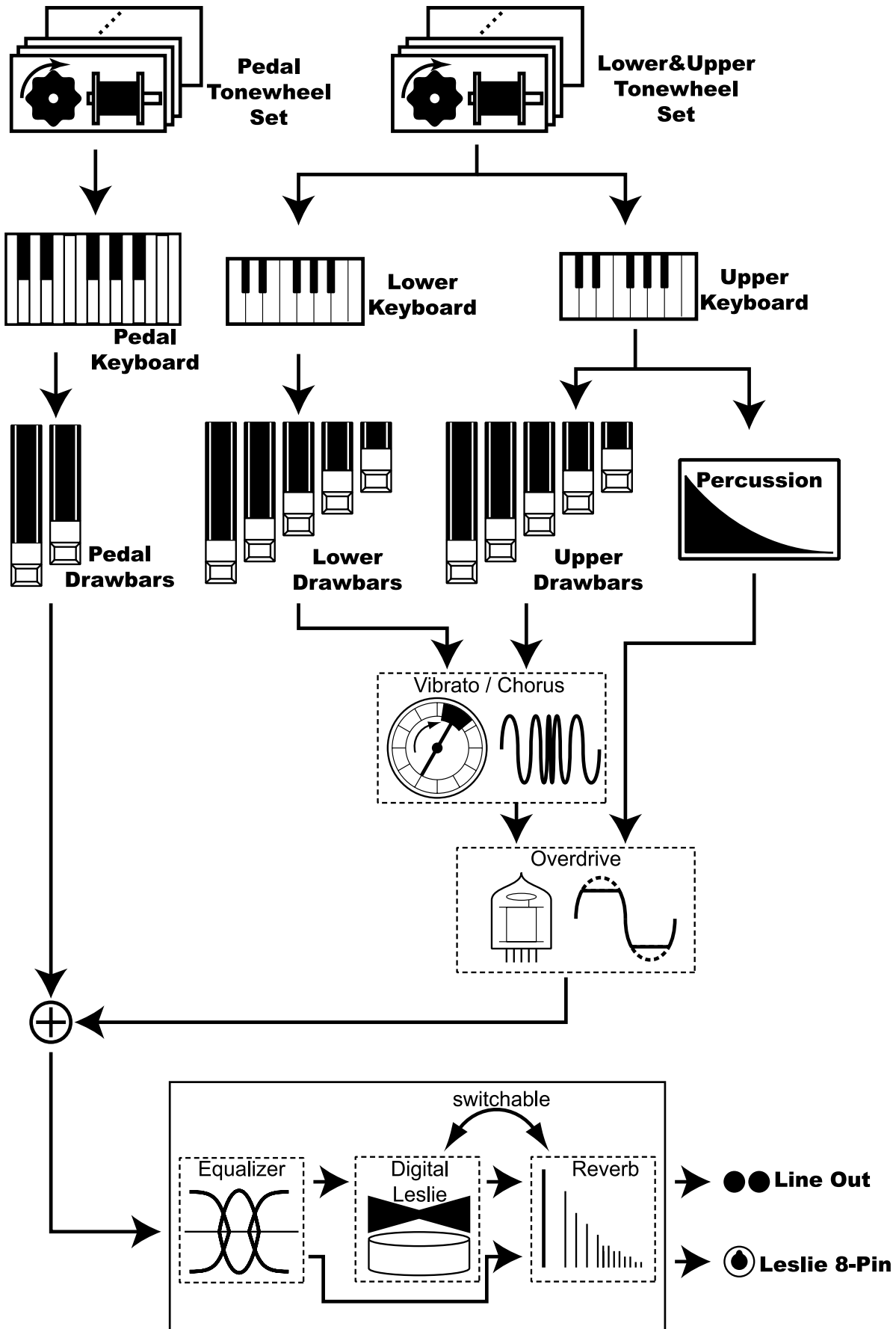

To fully enjoy playing this module, please read the following section of this manual.

See the illustrated System Structure of your keyboard on the left page.

tone-wheels

The sound source or “engine” of the Hammond Organ is the Tone-wheels. They are like the strings and pick-ups on the electric guitar. While running, each of the 96 digital Tone-wheels keeps oscillating at a different pitch/frequency.

keys

Each of the sound signals made by the 96 digital Tone-wheels is switched at each key. Each signal corresponding with each pitch and harmonic is distributed to each key (as an example, 9 signals for the manual keyboard). The keys are switched on and off by depressing and releasing the keys.

drawbars

The Drawbars prepare the basic sounds. Each bar adjusts the value of a harmonic (as an example, 9 harmonics for the manual keyboard).

percussion

The Percussion makes the decay sound, synchronizing with the key touch of the UPPER part.

vibrato/chorus

Vibrato gives vibration to the pitch. By mixing the vibrato sound with the fundamental sound, Chorus effect is obtained.

NOTE: On this module, the scanner circuit of the B-3/C-3 is simulated, which gives more effects than the changes of the pitch.

overdrive

Overdrive adds the fuzzy, raspy, “dirty” sound created by the vacuum tubes of a tube-style Leslie Speaker when its volume is pushed past its sound limit.

The PEDAL Part however, is designed not to pass through the Vibrato/Chorus or the Overdrive in order to obtain the clear Bass-line.

equalizer, leslie and reverb

The sound that comes out of the output terminal after passing the special effects: the Equalizer (for tone regulation), the Leslie (for the rotating speaker effects) and the Reverb (for resonance). (The built-in Leslie Effect cannot be heard through the Leslie 8-pin terminal.)

NOTE: The built-in Leslie Effect is designed to smoothly simulate the rotations of the two rotors.

tips TONE-WHEEL SET

The Tone-wheel Sets are divided into the Manual Keyboard and the Pedal Part. This is to give the Pedal Part the Decay (= the sound gradually fading out while pressing the key) or Sustain Effect. (= the sound gradually fading out after the key is released).

tips HARMONICS

Harmonic is a pitch of a different ratio to a certain pitch; for example, the one octave higher C to the middle C. The more Harmonics, the brighter and richer the sound.

HOW TO USE THE PANEL BUTTONS

The “Panel Buttons” are the 4 buttons for operating the same functions as those of the knobs and tablets on the panel of the HAMMOND ORGAN. The basic sounds of the HAMMOND ORGAN are created by the Panel Buttons, the [PARAM] button, and the [VALUE] knob.

EXAMPLE: Set Upper 8' of Drawbar registration at 5.

STEPS TO TAKE

- 1**

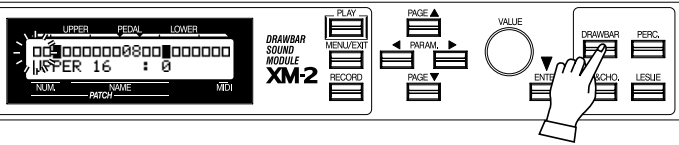

Touch the [DRAWBAR] button.
The display turns into Drawbar Registration mode.
- 2**

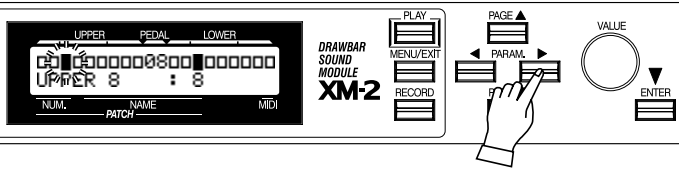

Touch the [PARAM] button and move the blinking cursor (value) to UPPER 8'.
- 3**

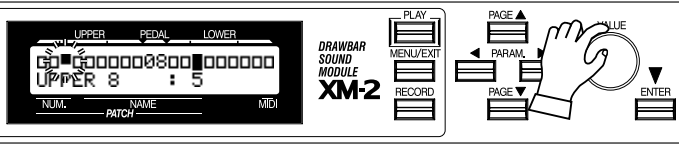

Set the value at 5 by the [VALUE] knob.
- 4**

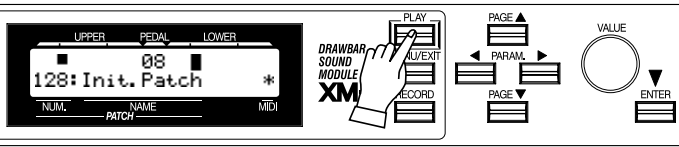

Touch [PLAY] to return to the PLAY mode.

This mode is for setting the Drawbar Registration to create the basic sounds.

To locate this mode:

Touch the [DRAWBAR] button.

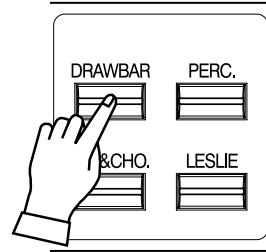

The first line in the display shows the Drawbar Registration of each part, from left to right, UPPER, PEDAL, LOWER. The parts UPPER and LOWER are displayed by bar graphs, and the PEDAL part by figures(numerals). The bottom line shows the currently selected length of bars (feet) and the values (levels).

You can change the value by selecting the length (footage) by the [PARAM] button and turning the [VALUE] knob.

The 9 Drawbars (only 2 for the PEDAL parts) on the HAMMOND ORGAN are used to create different sounds. On each Drawbar the numbers 1 to 8 are marked. When the Drawbar is pushed back until you can not see the number, the Drawbar does not give any sound. When you pull out the Drawbar to the full extent, the volume of the Drawbar is at its loudest setting.

This unit has no physical Drawbars, but you can do the same things as on the real organ by operating the displayed Drawbar Registrations.

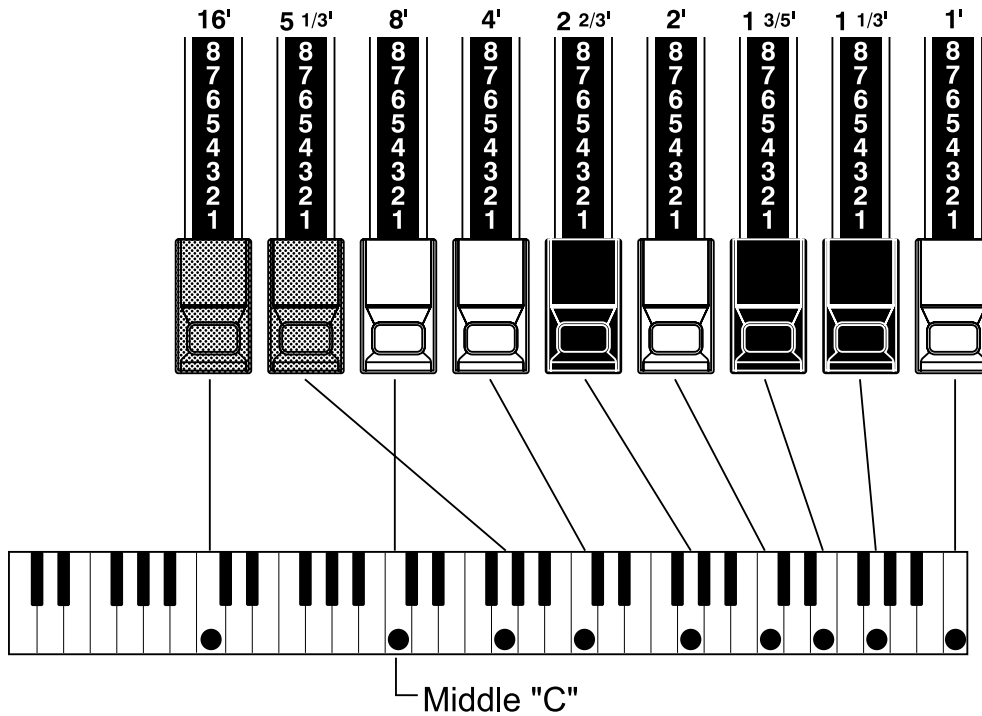

The pitch of each Drawbar is as shown above, when the middle C is depressed. The footage marked (') on each Drawbar is originated from the length of the pipes of the pipe organ.

The numbers 1 - 8 on each Drawbar indicate the volume of the sound to be produced as well as the guide to simply set the Drawbar.

For example, when you blow clarinet, the internal air vibrates, and the fundamental (8') and the third harmonic (2 2/3') plus the fifth harmonic (1 3/5') come out at the same time. On this module, if you pull out 3 Drawbars, you can get the clarinet sound. If you pull out the right hand side one of the 3 Drawbars a little longer and the left hand side one a little shorter, the element/component of the high pitch increases and a hard sound comes out. If you pull out the left hand one a little longer, on the contrary, the sound gets mellow.

Thus, you can make delicate changes to the sound, depending on the flow of the tune/music or your choice/preference, by fully utilizing the Drawbars.

NOTE: You can change the characters of the Drawbars. (P. 50)

WHITE DRAWBARS

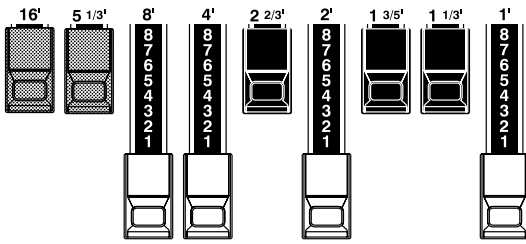

In each Drawbar set, the white Drawbar (8') on the left end makes the basic/fundamental sound. The other white Drawbars get higher by the octave to the right.

BLACK DRAWBARS

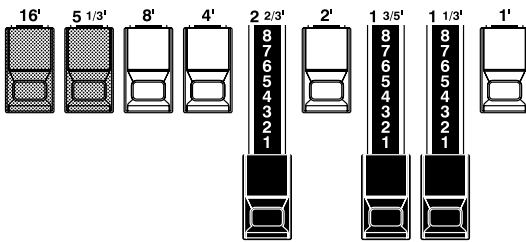

The sounds of the black Drawbars, too, play important roles in building rich tones. Their pitches are fifth and third to the fundamental. They contain the elements of all different harmonics of such as the sweet and soft horn, mellow strings and so on.

BROWN DRAWBARS

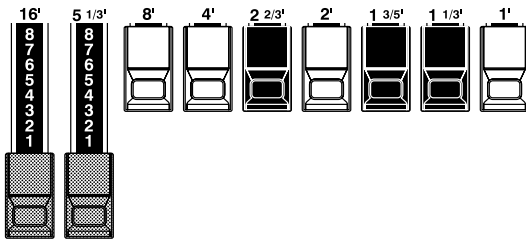

The two brown Drawbars on the far left have the role to give depth and richness to the sound. The left 16' is one (1) octave lower than the 8', and 5 1/3' is the third harmonic of the 16' fundamental.

Normally, the tones are built on the 8' fundamental, but, if you want to add depth to the tone or to expand the playing range on the manual by one (1) octave, the tones are built on the 16' fundamental.

PEDAL DRAWBARS

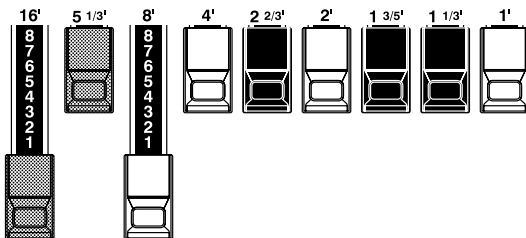

The Pedal Part is for playing the bass line usually, using the only two Drawbars -16' and 8'. Others are not used.

The first Pedal Drawbar produces a tone at 16' pitch for a deep foundation bass, while the second Pedal Drawbar produces a tone at 8' pitch, or one octave higher.

The registration of the Pedal Part is displayed in the center of the display, the left one is 16', and the right one is 8'.

DRAWBAR REGISTRATION PATTERNS

The Drawbar Registrations are usually represented by the numbers (footage values) of the 9 Drawbars. The following are the typical 4 patterns of registrations. You will see the instrument names together with the numerical registrations on the right hand side of each pattern.

The easiest way for you to obtain the basic tones you want is to remember the typical patterns of the combined 9 Drawbars.

Flute family (2 step pattern)

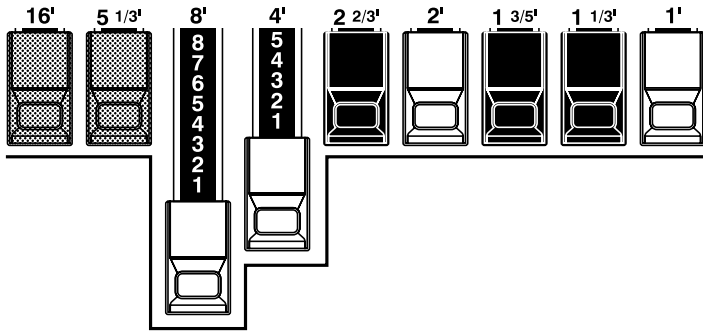

Accompaniment Flute 8' I	00 8460 000
Accompaniment Flute 8' II	00 3220 000
Accompaniment Flute 8' III	00 8600 000
Chorus of Flutes 16'	80 8605 002
Orchestral Flute 8'	00 3831 000
Piccolo 2'	00 0006 003
Stopped Flute 8'	00 5020 000
Tibia 8'	00 7030 000
Tibia 4'	00 0700 030
Tibia (Theater) 16'	80 8605 004
Wooden Open Flute 8'	00 8840 000

Reed family (triangle pattern)

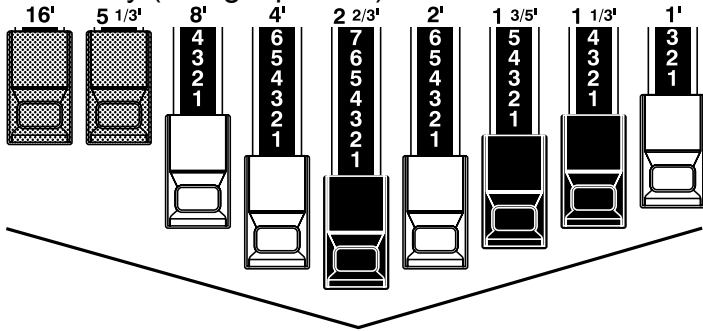

Bassoon 16'	44 7000 000
Clarinet 8'	00 6070 540
English Horn 8'	00 3682 210
Flugel Horn 8'	00 5777 530
French Horn	00 7654 321
Kinura 8'	00 0172 786
Oboe 8'	00 4764 210
Trombone 8'	01 8777 530
Trumpet 8'	00 6788 650
Tuba Sonora 8'	02 7788 640
Vox Humana 8'	00 4720 123

Diapason family (check mark pattern)

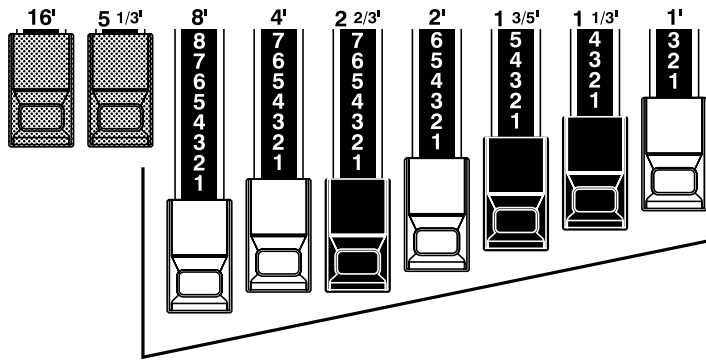

Accomp. Diapason 8'	00 8874 210
Chorus Diapason 8'	00 8686 310
Diapason 8'	00 7785 321
Echo Diapason 8'	00 4434 210
Harmonic Diapason 16'	85 8524 100
Harmonic Diapason 8'	00 8877 760
Harmonic Diapason 4'	00 0606 045
Horn Diapason 8'	00 8887 480
Open Diapason 8'	01 8866 430
Solo Diapason	01 8855 331
Wood Diapason 8'	00 7754 321

String family (bow pattern)

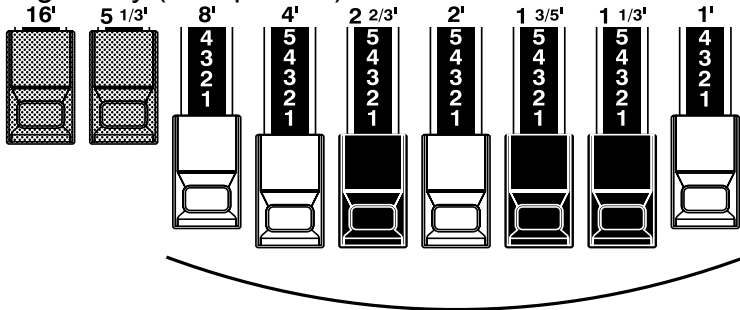

Cello 8'	00 3564 534
Dulciana 8'	00 7770 000
Gamba 8' I	00 3484 443
Gemshorn 8'	00 4741 321
Orchestral String 8'	00 1464 321
Salicional 8'	00 2453 321
Solo Viola 8'	00 2474 341
Solo Violin 8'	00 3654 324
Viola da Gamba 8'	00 2465 432
Violina 4'	00 0103 064
Violone 16	26 3431 000

PERC (PERCussion)

The Percussion attack sound is a Hammond exclusive.
Percussion is usually used with the Drawbar sound.

To locate this mode:

Touch the [PERC.] button.

```
PER- 2ND 3RD DCY VOL
CUSS OF ON FST SFT
```

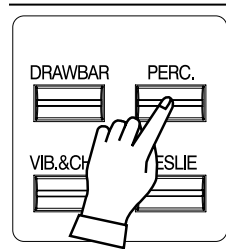

2ND (Second)

The second harmonic or 4' Drawbar decay is added to the UPPER Part.
To use this, set the value "ON".

3RD (Third)

The third harmonic or 2 2/3' Drawbar decay is added to the UPPER Part. By mixing it with the Drawbars, a distinctive sound is obtained.
To use this, set the value "ON".

DCY (DeCaY)

This sets the decay time for the Percussion.
It is effective if you use this to play with a clear-cut rhythm in an up-tempo piece.
Select "SLW" (slow) or "FST" (fast).

VOL (VOLume)

This sets the volume of Percussion.
Select "NOR" (normal) or "SFT" (soft).

NOTE: You can fine-adjust Percussion. (P. 61)

tips DECAY

The piano sound gradually goes out even if you keep the key down. This is called "decay". The violin on the contrary, keeps sounding at a certain volume. This is called "sustain".

NOTE

DRAWBAR CANCEL

When either the "2ND" or "3RD" is ON, 1' in the Upper Part Drawbars does not produce a sound. This is the same action as on the B-3/C-3.

NOTE: You can set to play 1' Drawbar, while Percussion is ON. (P. 61 #8)

VIBRATO adds warmth to the tone, by slightly changing the Drawbar pitch at a certain speed.

You can also add richness to the sound by mixing the Vibrato sound with the fundamental (= Chorus Effect).

To locate this mode:

Touch the [VIB.&CHO.] button.

VIB&	MODE	CHORUS
CHO	3	OF

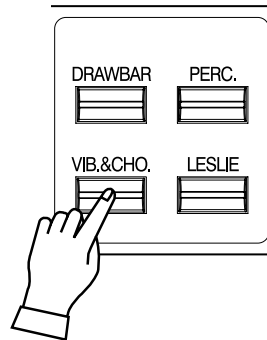

MODE

This sets the depth of Vibrato effect.

No effect at OF. The larger the value gets (1 to 3), the effect gets deeper.

CHORUS

This is for switching Vibrato and Chorus effects.

Turn this ON to get the Chorus effect.

NOTE: You can make fine settings for Vibrato and Chorus effects. (P. 65 #4 to 12)

LESLIE

LESLIE EFFECT is the simulated sound of rotating speakers.

If you connect the real Leslie speakers to this module, it controls those (speakers).

To locate this mode:

Touch the [LESLIE] button.

```

LES-  S/F  SW  OFF
LIE   FAST ON BRAK
    
```

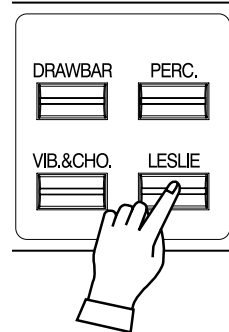

SW

Turn this ON to turn the Rotor. The sound is sent out from the Rotary Channel.

S/F

Select the Rotor speed from either SLOW or FAST.

OFF

This sets the operation when the SW is OF. Select either BRAK or THRU. BRAK stands for Brake. (The Rotor gradually slows down and finally stops.) THRU stands for Through. (The Leslie effects are bypassed, and the sounds are sent out from the stationary channel.)

NOTE: You can not control the Brake or Through on external Leslie Speakers.

NOTE: You can fine-set the LESLIE effect, i.e. the Leslie speed. (P. 62)

tips PARAMETERS AND STATUS

Parameter			State	
S/F	SW	OFF MODE	External Leslie Speaker	Internal Leslie Effect
Fast	On	Brak	Fast	
Fast	On	Thru	Fast	
Slow	On	Brak	Slow	
Slow	On	Thru	Slow	
Fast	Off	Brak	Brake	
Slow	Off	Brak	Brake	
Fast	Off	Thru	Fast	Through
Slow	Off	Thru	Slow	Through

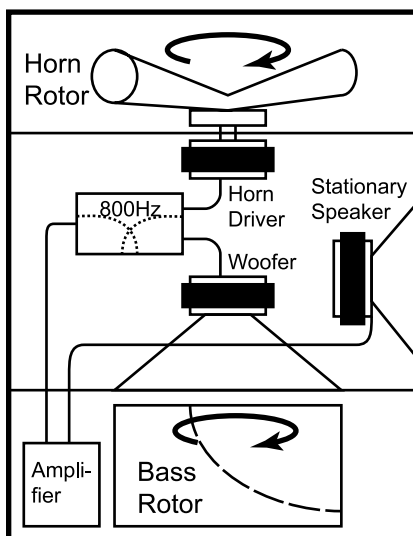

tips WHAT IS THE LESLIE EFFECT?

In the Leslie speakers, generally an amplifier and two rotors are incorporated, i.e. the "Horn Rotor" responsible for the treble and the "Bass Rotor" for the bass.

Each rotor has a speaker or speakers and a motor for controlling the speed to give the unique tremolo sound gained by the Doppler effect.

There are also models that have not only the rotors but also stationary speakers - switchable.

The circuit to send the sound to the rotor is called "Rotary Channel" and that to the stationary speaker is called "Stationary Channel".

The built-in Leslie Effect simulates them and you can get the best effect when connected to a stereophonic amplifier and speaker system.

The settings you have made can be recorded into the Patches.

NAME THE PATCH

- 1 Go to the MENU.

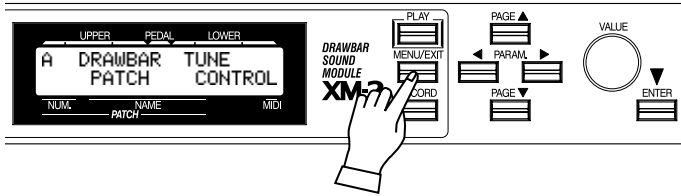

Touch the [MENU/EXIT] button.
The MENU mode will be displayed.

- 2 Go to PAGE A.

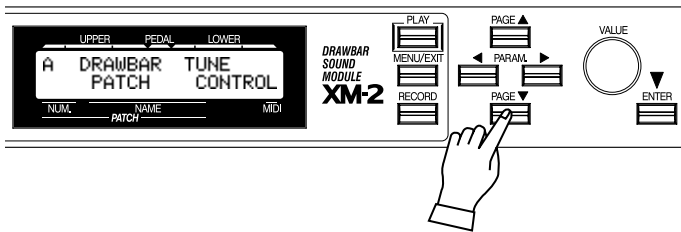

If the PAGE A is not displayed, touch the [PAGE] button and go to PAGE A.

- 3 Go to the PATCH function mode.

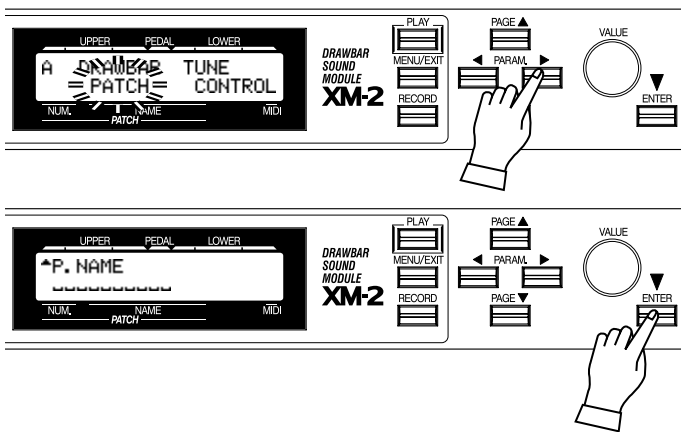

Select the PATCH by using the [PARAM] button. Touch the [ENTER] button and go to the PATCH function mode.

- 4 Input the NAME.

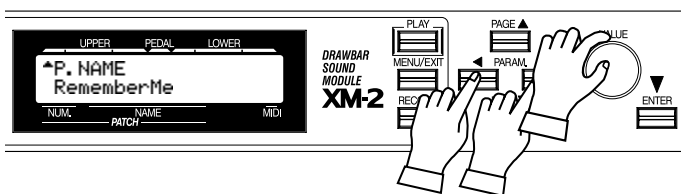

You can store names using up to 10 letters.

[PARAM] Button: moves the cursor.

[VALUE] Knob: selects letters.

You can use all the Alphabet letters large and small, signs/symbols and digits.

The name input here is only temporary. Do the recording operation to save it, as explained on the next page.

RECORD A NEW PATCH

EXAMPLE: RECORD INTO "011".

- 1 Touch the [RECORD] button.

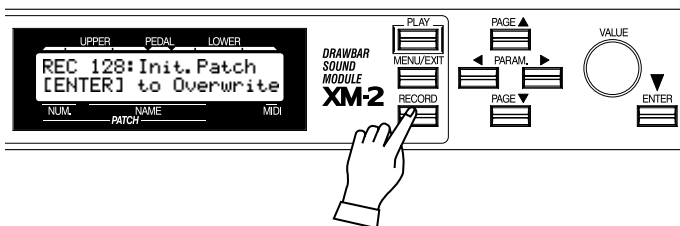

Touch the [RECORD] button. The [RECORD] mode appears on the display.

- 2 Select the Patch number.

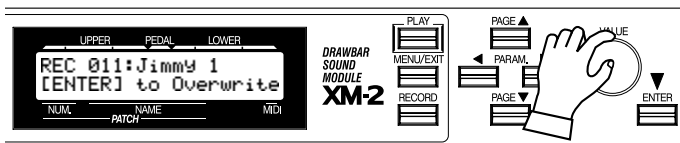

Select by the [VALUE] knob the patch number you wish to record in. (No. 011 in this example)

- 3 Touch the [ENTER] button.

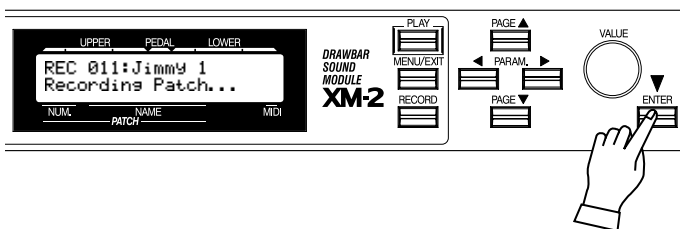



Touch the [ENTER] button.

The Patch will be decided and the following message will appear in the display for a few seconds:
Recording Patch ...

When the recording is completed, the display returns to the previous one.

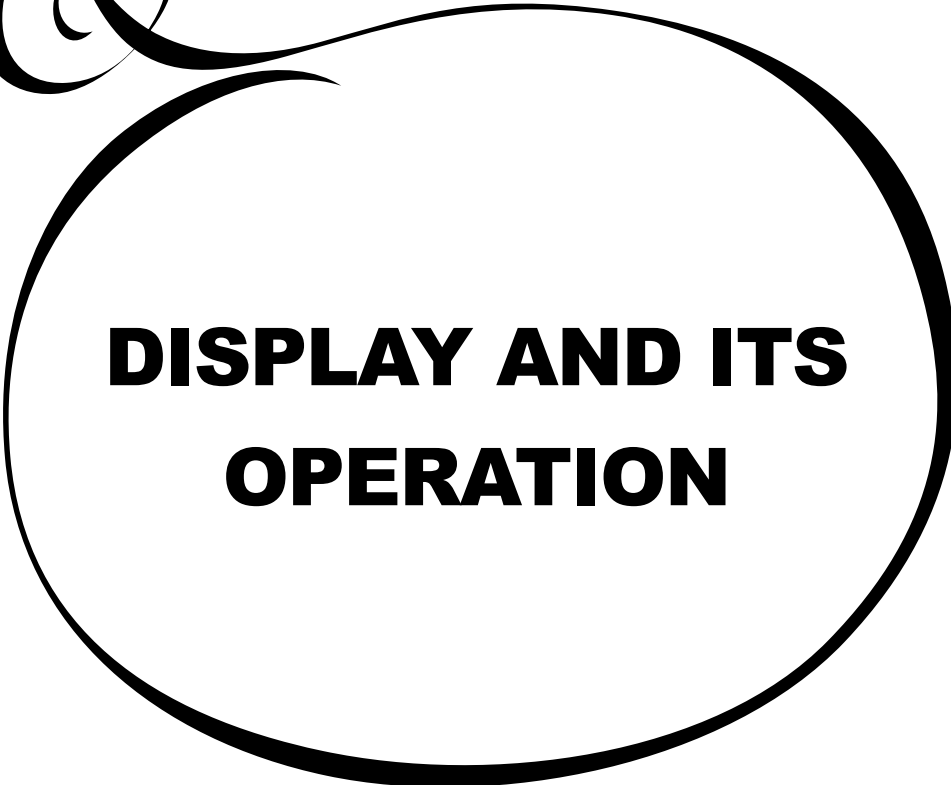
NOTE: The recorded Patch data is not lost even after the power is turned off.



**DISPLAY AND ITS
OPERATION**

The PLAY MODE is the basic display for all the operations. The necessary information for the normal play will be displayed.

There are two types of PLAY MODE screens to display the Drawbar Registration. One is by showing the length of the Drawbars and the other by digits.

To locate this mode:

1. The PLAY mode will be displayed immediately after the power is turned ON and the start-up steps are completed.
2. Touch the [PLAY] button if the displayed mode is wrong.

HOW TO READ THE DISPLAY

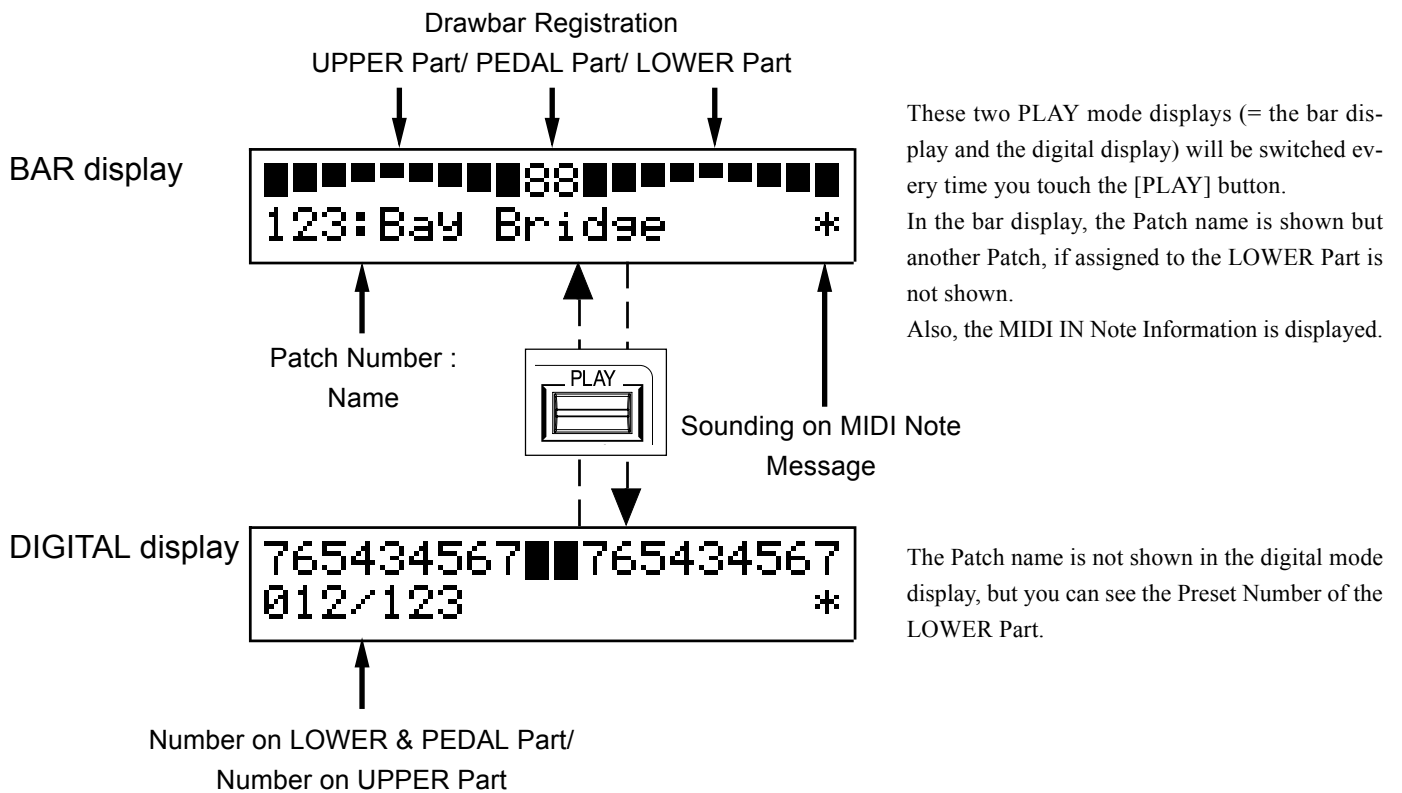

The Panel Button mode is used for controlling the same functions as the knobs and tabs do on the HAMMOND ORGAN.

By using the Panel Buttons, the [PARAM] buttons, and the [VALUE] knobs, you can create the basic sounds of the HAMMOND ORGAN.

To locate this mode:

Touch one of the Panel Buttons you want to set; [DRAWBAR], [PERC], [VIB&CHO], and [LESLIE].

HOW TO READ THE DISPLAY

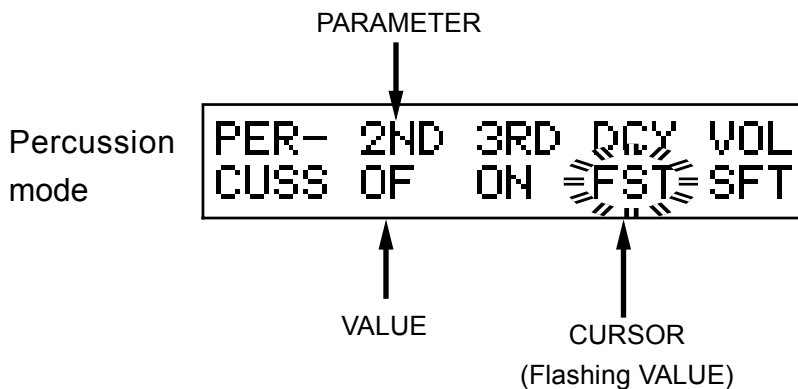
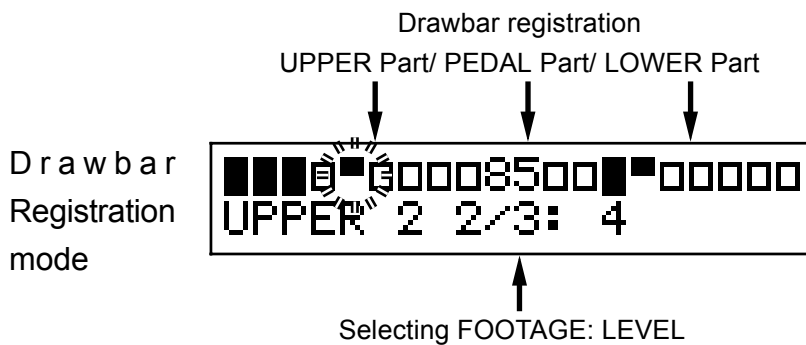

tips CURSOR

In the display window of this keyboard, the CURSOR is displayed in the flashing style, while the most popular indicator- cursor used on the PC, the mobo, etc. is in the shape of an arrow, a square or an I-shape.

BUTTON OPERATION IN THIS MODE

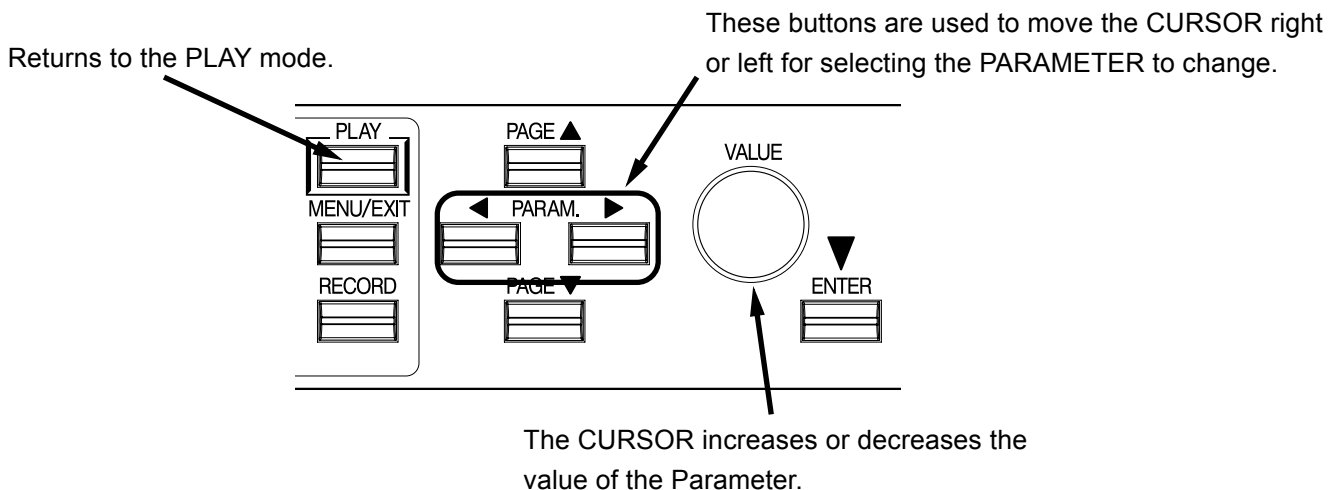

MENU MODE

The MENU mode is the path for each function.

To locate this mode:

Touch the [MENU/EXIT] button.

There are several pages which contain many various FUNCTION displays. Move from page to page and find the item where you want to go, select item by [PARAM] button, and touch the [ENTER] button to see the desired display.

HOW TO READ THE DISPLAY

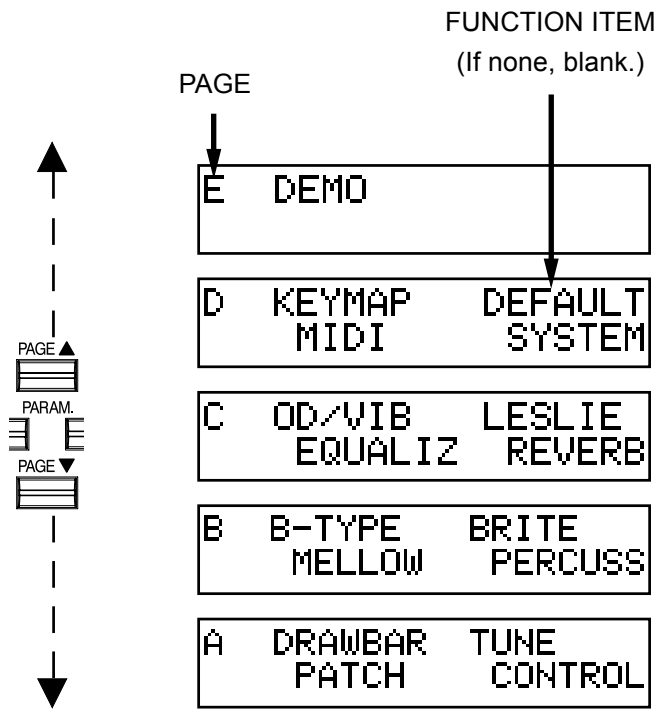

BUTTON OPERATION IN THIS MENU

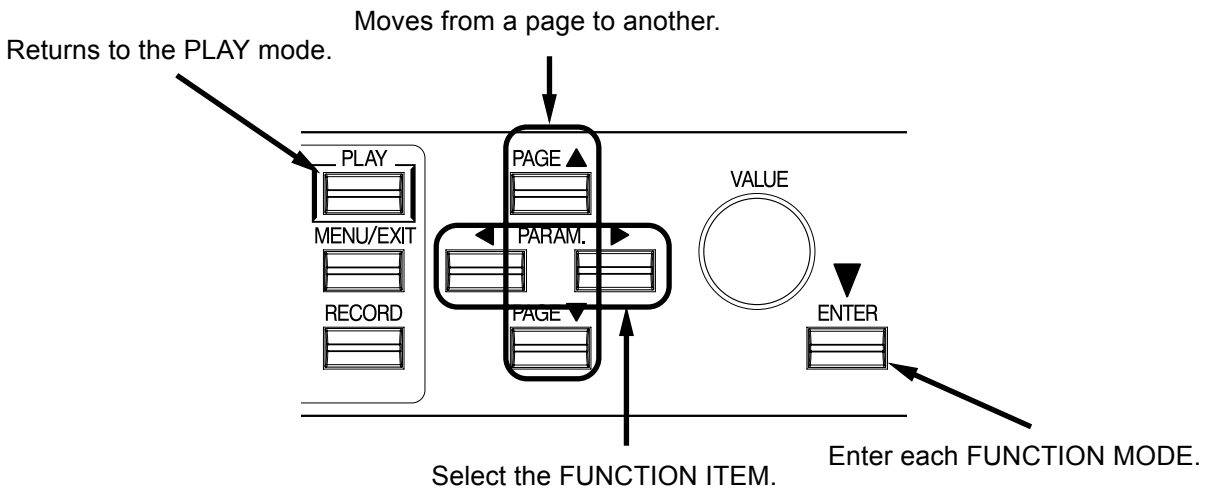

The FUNCTION MODE is for making each setting and adjustment.
There are many displays, but the basic operation is the same.

HOW TO READ THE DISPLAY

This shows there are
PAGEs above (or below).

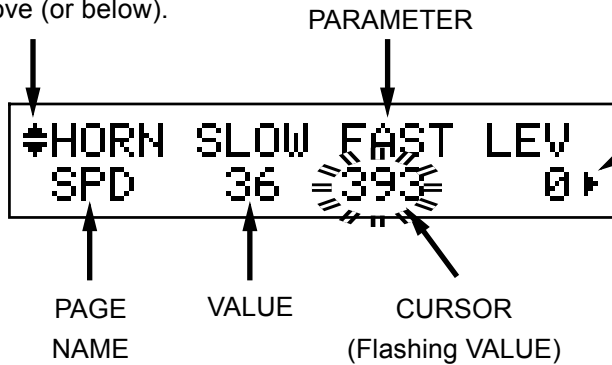

This shows there is a PAGE on
the right (or on the left).

BUTTON OPERATION IN THIS MODE

Returns to the
PLAY mode.

Moves from a page to another.

The CURSOR increases or
decreases the value of the
Parameter.

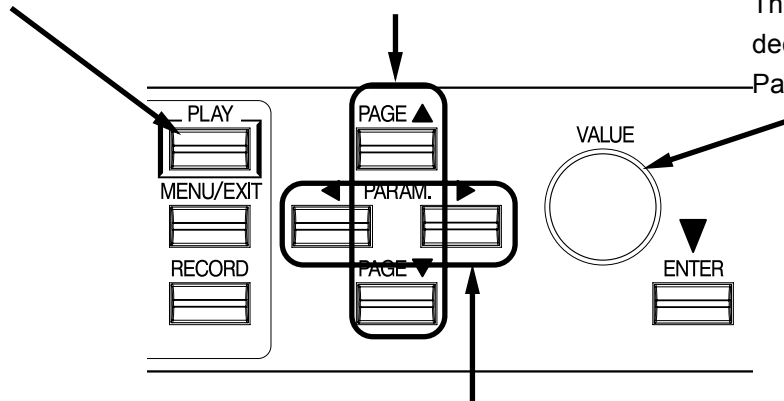

This button is used to move the CURSOR
right or left for selecting the PARAMETER
to change.
The CURSOR moves to the edge of the
display and onto the next page (on the right
or the left), if there is one.

EXAMPLE: Adjusting the DECAY TIME of the Percussion [FAST]

- 1 Go to the MENU Mode.

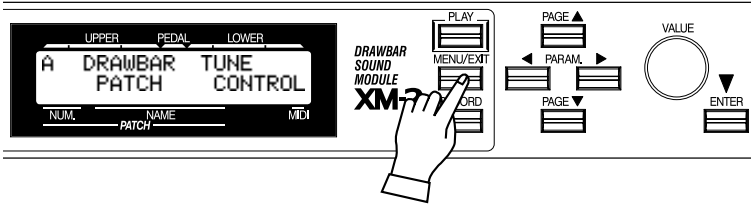

Touch the [MENU] button.
The [MENU] mode is displayed.

- 2 Select the PAGE.

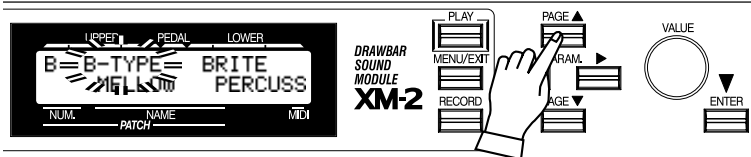

Search for the “PERCUS” page, using the [PAGE] button.
“PERCUS” is on PAGE B. So select PAGE [B].

- 3 Select the FUNCTION.

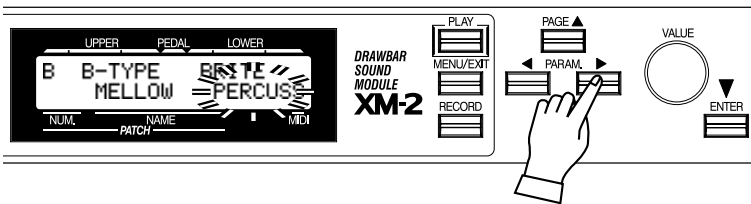

Choose the “PERCUS” by using the [PARAM] button.

- 4 Touch the [ENTER] button.

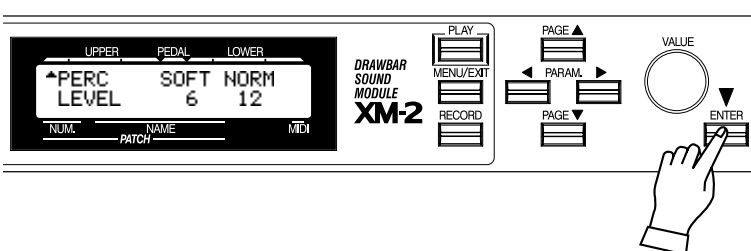

Touch the [ENTER] button.
Now you are on the (first page) of the Percussion Function mode.

- 5 Move the CURSOR to the Parameter you want to change.

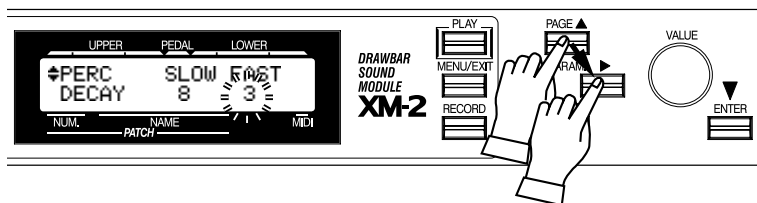

DECAY TIME is on the “DECAY” PAGE. Move to that page using the [PAGE] button.

“FAST” is on the right end. Move the CURSOR (flashing value) to underneath “FAST” using the [PARAMETER] button.

- 6 Change the value.

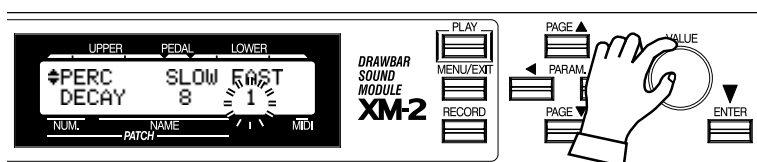

Decrease the value, using the [VALUE] button or the [VALUE] knob.

NOTE: Repeat the operation 1 - 6, if you want to change other parameters, too.

- 7 Back to PLAY mode.

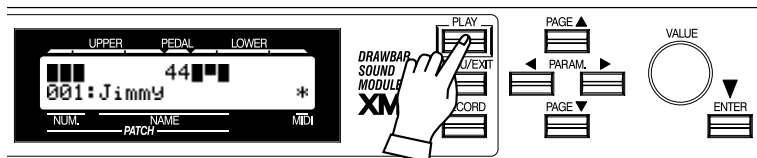

Touch the [PLAY] button to return to the PLAY mode.

- 8 Record a new Patch.

The “DECAY FAST” is a Patch Parameter. It will go back to the set value if you call out the other (or current) Patch.

If you want to continue to use the changed value hereafter, you must record the value into the Patch.

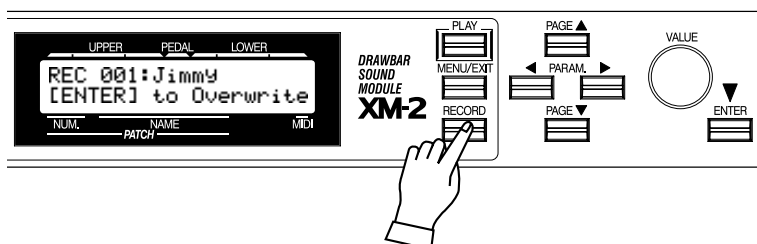

tips PATCH PARAMETERS

They are the Parameters to be recorded into each Patch.

They include the Drawbar Registrations, Parameters for panel buttons, “Decay Fast” and many others.

The overall/general common Parameters (which are not included in the Patches) are called “Global Parameters.”

SHORT CUT TO THE FUNCTION MODE

Each Panel Button has a “SHORT-CUT” capability, so that you can easily go to each Function mode. By holding down the button, you can easily go to the desired mode display. The “SHORT-CUT” mode can save time by going directly to the parameters you want to change.

EXAMPLE: Move to the Percussion Function Mode.

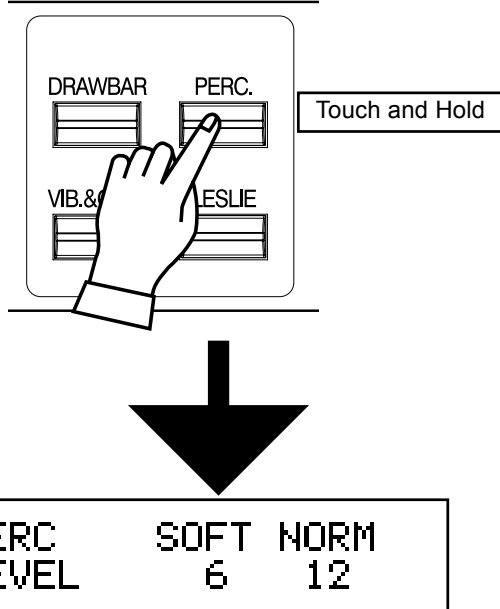

For example, if you want to change the Percussion setting, you can go to the PERCUSSION FUNCTION MODE display, by holding down the [PERC.] button for a few seconds. This enables the “SHORT CUT” mode.

The Short-cut works on the following:

[DRAWBAR]DRAWBAR
 [PERC.] PERCUSSION
 [VIB&CHO] VIB/OD
 [LESLIE] LESLIE

NOTE: You can change the time for holding down the button for “SHORT CUT”. (P. 57 #21)

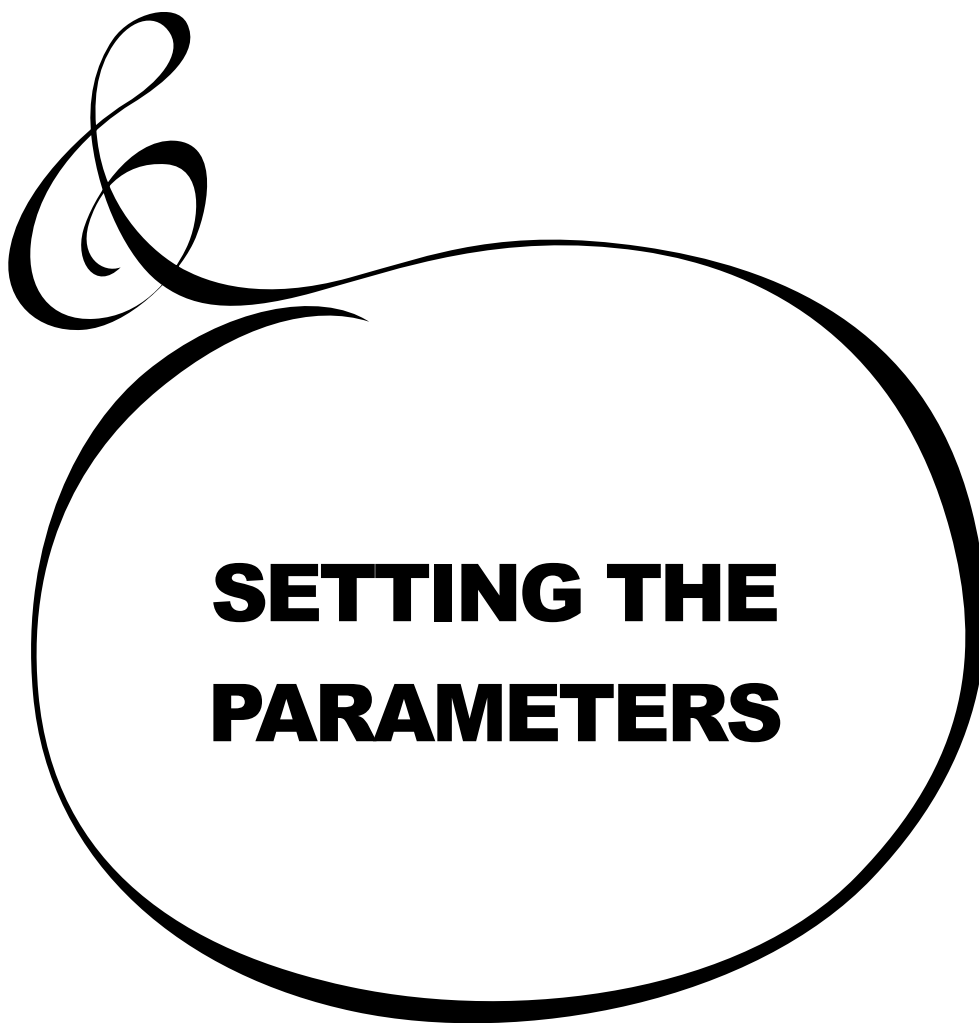

In this mode, you can set the Parameter relating to the Drawbar sound of each part.

To locate this mode:

1. Touch the [MENU/EXIT] button and display the MENU, touch the [PAGE] button and select PAGE A, choose "DRAWBAR" by the [PARAM] button, and touch the [ENTER] button.
2. Another option is to hold down the [DRAWBAR] button for a certain length of time.

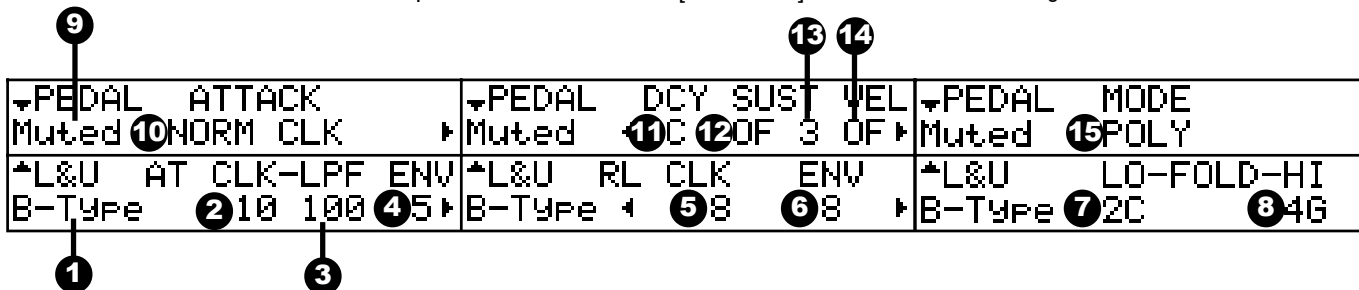

◆ Setting the Manual (LOWER and UPPER)

1. TONE-WHEELS

Select the TONE-WHEEL SET (waveform) for the manual part.

- B-type: The traditional Tonewheel Sound of B-3/C-3
- Mellow: Sine wave
- Brite: The analog sound represented by X-5

2. CLICK - ATTACK LEVEL

This allows you to set the Key-Click VOLUME of the ATTACK (= when you touch the key). The larger the value, the louder it gets. No key-click at 0.

NOTE: When this parameter is changed, also 4. Envelope - Attack Rate will be changed to Loudness its suitable value automatically.

3. CLICK - LPF

This allows you to set the tone of the Key-Click.

The setting range is 0 - 127. The larger the value, the brighter it gets.

4. ENVELOPE - ATTACK RATE

This allows you to set the speed of the Drawbar at Attack (when you touch the key). The more the value, the slower it gets. The volume will be maximum(= loudest) at 0 at the time you touch the key.

5. CLICK - RELEASE LEVEL

This allows you to set the volume of the Key-Click at RELEASE (= when you release the key). The larger the value, the louder it gets. No Key-Click at 0.

NOTE: When this parameter is changed, also 6. Envelope - Release Rate will be changed to its suitable value automatically.

6. ENVELOPE - RELEASE RATE

This allows you to set the Decaying Speed of the Drawbar Sound at Release (when you release the key). The higher the value, the slower the RELEASE gets. The sound dies at 0 at the same time as you release the key.

7. FOLD-BACK - LOW

This allows you to set at which key the 16' Drawbar starts the FOLD-BACK. (Fold-back: Repeating the same octave in a certain range on the keyboard.)

The first key (= MIDI note number 36) is displayed as "1C". The setting range is 1C - 2C.

tips TONE-WHEEL SET

Each Tone-wheel Set allows you to make finer adjustment. (P. 60)

tips KEY-CLICK

The "Key Click" is the noise heard every time the key is touched or released on the B-3/C-3, as the voice is generated by mechanically switching ON and OFF on these models. The function on this model simulates the good old noise.

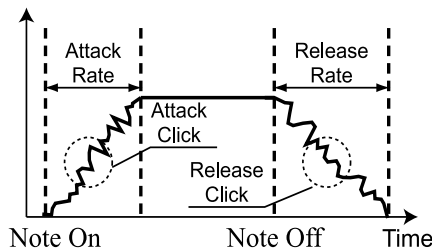

Oscillation of
Tone-Wheel

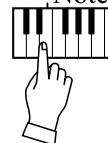
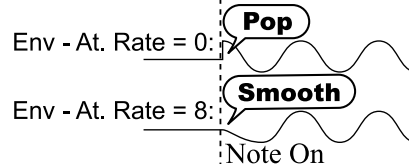

tips FOLD-BACK

As the number of the tonewheels was limited on the B-3/C-3, the organs were designed to repeat the same octave in the upper-most or lower-most range. The feature of this model is to simulate that.

8. FOLD-BACK - HIGH

This allows you to set which key the 1' Drawbar starts to FOLD-BACK (= repeat the same octave) in the upper-most range. The set range is 4G - 5C.

NOTE: The FOLD-BACK can be set not only on the 1' but also 1 1/3', 1 3/5', 2' and 2 2/3' Drawbars.

◆Setting the PEDAL

9. TONE-WHEELS

This allows you to select the Tone-wheel waveform of the PEDAL part.

- Normal: The traditional B-3/C-3 Tone-wheel sound
- Muted: Analog sound represented by the X-5.
- Synth1: Sawtooth waveform with swept filter.
- Synth2: Dull square waveform.

10. ATTACK

This allows you to set the Attack Rate and the Key-Click Volume at ATTACK and RELEASE.

- MAX CLK: Immediately attacks and the key-click is loud.
- NORM CLK: Immediately attacks and the key-click is normal.
- SOFT CLK: Immediately attacks and the key-click is soft.
- NO CLK: A slightly slower attacks without key-click
- SLOW ATK: Slow attack without key-click

11. DECAY RATE

This allows you to determine whether to keep voicing or to decay, or set the decay time, while holding down the key.

The setting range is 1 - 5 and C. The longer the value gets, the longer is the decay time. No decay at C.

12. SUSTAIN - ON

This allows you to set whether or not to use the Sustain function.

13. SUSTAIN - LENGTH

This allows you to set the Release Rate (= the decay time after you release the key), when the SUSTAIN - ON (item #12) is ON.

1 is the shortest. And 5 is the longest.

14. VELOCITY

This allows you to set the response to the Velocity. The setting range is OF and 1 - 4. At OF, the volume does not change however hard you may touch the key. As the value increases from 1 - 4, the sound gets louder even if you touch the key softly.

15. KEY MODE

This allows you to set the Pedal polyphony.

- POLY: Makes it possible to play chords (up to 3 notes)
- MONO: Only the lowest note will sound, when you play a chord.

NOTE: The previously released note will be cut when you touch the new one, even when the PEDAL is in the POLY mode and SUSTAIN is ON.

NOTE: When the note-data of the Pedal are received from the MIDI IN terminal while the value of the parameter [MIDI IN] (P. 68 #2-4) is "CH", the Pedal produces polyphonic sound, regardless of the value.

NOTE: All the parameters in these modes are Patch Parameters. They are recorded into the Patch.

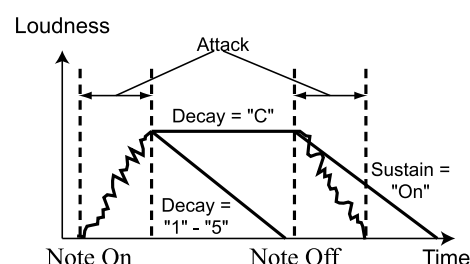

tips SUSTAIN

This is the function that the volume slowly fades out after the key is released, not like that of the synthesizers.

tips VELOCITY

"Velocity" is the speed of the key is depressed. When you touch the piano hard, the hammer hits the string hard and so the sound is loud. The organ key is, on the other hand, generally only the switch to open the valve, and so the sound does not change however hard you may touch the key. So this function is effective if you use it when the Decay Rate is other than C, or Decay.

In this mode, you can give names to patches, set how to recall them, and set the Preset Buttons for the Drawbar Controller XMc-2.

To locate this mode:

Touch the [MENU/EXIT] button and display the MENU, touch the [PAGE] button and select PAGE A, choose "PATCH" by [PARAM] button, and touch the [ENTER] button.

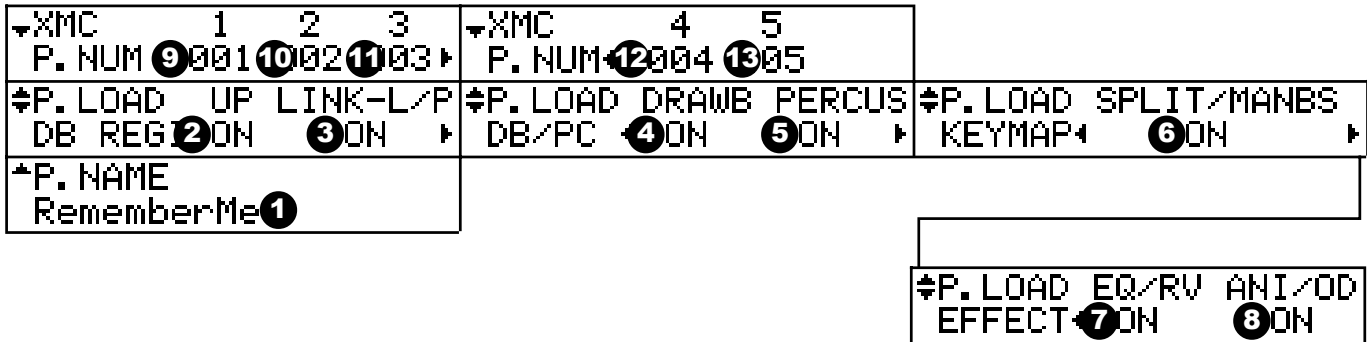

◆ PATCH NAME

1. PATCH NAME (P)

This allows you to name the present Patch using up to 10 letters. Move the cursor with the [PARAM] button, and choose the letters with the [VALUE] knob.

This change will be lost if you do not record it, same as the other Patch Parameters.

NOTE: The parameters by the names with (P) on the tail are Patch Parameters, and are recorded to each Patch.

◆ PATCH LOAD

This allows you to set the operation when you recall the Patch.

2. PATCH LOAD - UPPER (B)

This allows you to set whether or not to recall the Drawbar Registration of UPPER Part.

3. PATCH LOAD - LINK LOWER/PEDAL (G)

This allows you to determine whether or not to recall the Drawbar Registration of the LOWER and the PEDAL Parts.

4. PATCH LOAD - DRAWBAR (B)

This allows you to determine whether or not to recall the Parameters relating to the Drawbars of each Part, such as the Tonewheel Set.

5. PATCH LOAD - PERCUSSION (B)

This allows you to determine whether or not to recall the Parameters relating to Percussion.

6. PATCH LOAD - SPLIT / MANUAL BASS (G)

This allows you to determine whether or not to recall the Parameters relating to the SPLIT or the MANUAL BASS.

7. PATCH LOAD - EQ/RV (G)

This allows you to determine whether or not to recall the Parameters relating to the EQUALIZER and REVERB.

8. PATCH LOAD - ANI/OD (G)

This allows you to determine whether or not to recall the Parameters relating to VIBRATO, OVERDRIVE and LESLIE.

◆ PATCH NUMBERS

9. to 13. PATCH NUMBERS (G)

Set the Patch Numbers for assigning to each Preset Button on the Drawbar Controller XMc-2.

This setting can be made not only by this operation but also by touching the Preset buttons on the XMc-2 holding down the [RECORD] button on this unit.

NOTE: Each Parameter (G) of Patch Load except LINK LOWER/PEDAL is a Global Parameter, which is recorded at the time of setting, and common in each Patch.

EFFECTIVE USE OF LINK-LOWER/PEDAL

This is a function to set for switching and recording only at the Program Change to the LOWER part, without operating the Patches of the LOWER and the PEDAL at the Program Change to the [VALUE] knob or the UPPER part of this unit.

The Preset Keys on B-3/C-3 are independent, key by key, and so they were operated independently. This function simulates that.

WHEN LINK LOWER/PEDAL IS ON:

When you call out the Patches by the [VALUE] knob of this unit, or receive the Program Change to the UPPER part, the Patches of all parts (UPPER/LOWER/PEDAL) change.

After this, to change the Patches for the POWER/PEDAL parts, send the corresponding Program Change to the LOWER part.

The settings are recorded to the Patches for all parts (UPPER/LOWER/PEDAL) in the operation of this unit.

To record only the settings of the LOWER/PEDAL parts to the Patches, send the Program Change to the LOWER part, holding down the [RECORD] button on this unit.

WHEN LINK LOWER/PEDAL IS OFF:

When you call out the Patches by the [VALUE] knob of this unit, or receive the Program Change to the UPPER part, only the Patch of the UPPER part changes.

To call out the Patches for the POWER/PEDAL parts, send the corresponding Program Change to the LOWER part.

The settings are recorded to the Patches only for the UPPER part in the operation of this unit.

To record the settings of the LOWER/PEDAL parts to the Patches, send the Program Change to the LOWER part, holding down the [RECORD] button on this unit.

If different Patches are selected between the UPPER and the LOWER/PEDAL, the display will be like this.

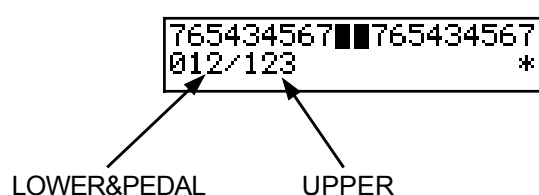

In this mode, settings of various controllers are made.

Effects can be set to the controllers mounted on the MIDI keyboards connected to this unit such as Pitch Bend, Pressure, etc. Also, there are connecting terminals for the Foot Switch and the Expression Pedal on the rear panel. You must select and set their purpose.

To locate this mode:

Touch the [MENU/EXIT] button and display the MENU, touch the [PAGE] button and select PAGE A, choose "CONTROL" by the [PARAM] button, and touch the [ENTER] button.

↓DISP SH. CUT TIMEOUT ①1 sec ②NO			
↕FOOT TIP SW ①9 LESLIE S/F ALT ▶	↕FOOT RING SW ②0 LESLIE S/F ALT		
↕EXPR SOURCE MON ESSN ⑬ PED (NORM) ⑭ 127	↕EXP. LEV LF-LIM-HF MIN ⑮-35 ⑯-25 ⑰-30 ▶	↕EXP. GAIN MON CALIB ⑱ 10% ⑲ 127	
↕PRE- LESLIE OD BEND SS ⑩ FAST ⑪ OF ⑫ OF			
↕MOD LESLIE OD ⑧ SPEED ⑨ OF			
↕BEND -L&U+ -PED+ RANGE ① 12 ② 2 ③ 12 ④ 2 ▶	↕BEND MODE TIME AMP OPT ⑤ BEND ⑥ 3.5 ⑦ OF		

◆PITCH BEND

1. BEND - L&U DOWN (P)
2. BEND - L&U UP (P)
3. BEND - PEDAL DOWN (P)
4. BEND - PEDAL UP (P)

These are for setting the changing range of the PITCH-BEND by the semi-tone.

Both the LOWER and the UPPER PARTS change at the same time, as they use the same Tone-Wheels.

The setting range is 0 - 12 for up, 0 - 24 for down.

5. BEND - MODE (P)

It switches the function of the PITCH BEND information.

BEND:

You can slide the pitch by changing the PITCH BEND information.

MOTOR:

You can control the TONE-WHEEL motor. The motor turns on when it is in the center or in the neutral position, stops when you turn down, and accelerates when you turn up.

6. BEND - TIME (P)

This sets the time for slowing down to stop or accelerating the motor when it [= MODE(5)] is in the MOTOR mode.

The value ranges from 0.1[s] to 5.0[s].

7. BEND - AMPLIFIER (P)

This decides whether to turn off the amplifier or not by turning down the PITCH BEND information.

tips MOTOR

There is no pitch-bend function on the B-3/C-3. So some musicians turned off the power while playing it in order to get that effect.

If the B-3/C-3 is turned off, the Tone-wheel motor gradually slows down and stops, and the amplifier does as well. This function is to simulate that on this model.

tips HOW PITCH BEND MODE WORKS

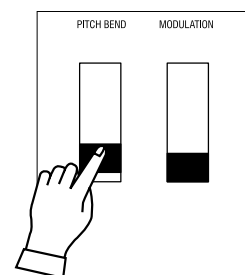

BEND: The pitch immediately falls.

MOTOR: The pitch gradually falls down to the set point.

◆MODULATION

8. MODULATION - LESLIE (P)

Use this for controlling the speed of the Leslie effects by the Modulation Information.

SPEED:

This changes the speed of the Leslie effects according to the Modulation Information between Slow to Fast, continuously.

FAST:

If the Modulation value is less than 63, the mode of the Leslie effect is SLOW. If 64 or higher, FAST.

OFF:

It does not function

9. MODULATION - OVERDRIVE (P)

Use this for controlling the amount of OVERDRIVE by the Modulation Information.

ON: The amount of OVERDRIVE changes according to the Modulation Information.

OF: Does not function.

tips BRAKE ON MODULATION

If you want to “Brake” the Leslie effect by pulling the modulation wheel forward, set the Slow Speed to “0” on Leslie Parameter (P. 62).

◆PRESSURE

10. PRESSURE - LESLIE (P)

Use this for controlling the speed of the Leslie effects by the Pressure Information.

SPEED:

The speed of the Leslie effects continuously changes between SLOW and FAST in accordance with the Pressure Information.

FAST:

The mode of the Leslie effects gets SLOW when the Pressure value is less than 32, and goes FAST when the value is 81 or more.

OFF:

Does not function.

11. PRESSURE - OVERDRIVE (P)

Use this for controlling the amount of OVERDRIVE by the Pressure Information.

ON: The amount of OVERDRIVE changes according to the Pressure Information.

OF: Does not function.

12. PRESSURE - PITCH BEND (P)

Use this for controlling the amount of PITCH BEND by the Pressure Information.

UP:

The pitch goes up in accordance with the Pressure Information.

DOWN:

The pitch goes down in accordance with the Pressure Information.

OFF:

Does not function.

NOTE: The parameters by the names with (P) on the tail are Patch Parameters, and are recorded to each Patch. (G) is for “Global”. These parameters will be recorded when set, and are common in each Patch.

↵DISP SH. CUT TIMEOUT ①1 sec ②NO		
↵FOOT TIP SW ①9LESLIE S/F ALT ▶	↵FOOT RING SW ②0LESLIE S/F ALT	
↵EXPR SOURCE MON ESSN ⑬PED (NORM)⑭127	↵EXP. LEV LF-LIM-HF MIN ⑮35⑯25 ⑰30 ▶	↵EXP. GAIN MON CALIB ⑱110% ⑲127
↵PRE- LESLIE OD BEND SS ⑩FAST ⑪OF ⑫OF		
↵MOD LESLIE OD ⑧SPEED ⑨OF		
↵BEND -L&U+ -PED+ RANG ①12 ②2 ③12 ④2 ▶		
↵BEND MODE TIME AMP OPT ⑤BEND ⑥3.5 ⑦OF		

◆ EXPRESSION

13. EXPRESSION - SOURCE (G)

Determines what to use for controlling the Expression.

PED(NORM):

Uses V-20R etc.

PED(REV):

Uses KORG XVP-10 etc.

MIDI IN:

Uses the Expression Information received at the keyboard channel UPPER.

14. EXPRESSION - MONITOR

Displays the present Expression Value. You can find the causes for such troubles as “no sound”, “non-function” of the Expression Pedal, by checking if the Expression Value changes normally. Also, this can be a guide when you want to play the “fade in” from “quiet”.

15. EXPRESSION - MINIMUM LEVEL (G)

It sets the output level when the Expression is the minimum.

The setting range is OFF, -60db to 0db. “OFF” makes no sound when the Expression is minimum, “0db” does not reduce the volume level.

16. EXPRESSION - LIMIT LF (G)

17. EXPRESSION - LIMIT HF (G)

These are for setting the level to maintain for low and high frequencies when the Expression is the minimum.

The setting range is OFF, -60dB to 0dB. This function does not work at “OFF”. Otherwise the level is maintained even if the Expression is minimum.

18. EXPRESSION - GAIN (S)

This is for adjusting the gain (=range of the change) of the connected expression pedal. It sometimes occurs that, even if you press the expression pedal all the way down, the expression value does not reach the maximum value (127), due to the difference of each expression pedal model from model. In such a case, adjust this parameter for getting the maximum range of the change.

NOTE: This parameter is a System Parameter. This parameter will be recorded when set. It is common in each Patch.

tips EXPRESSION LIMIT

One of the human ear’s characteristics is that, when the volume falls, the sound of high or low frequency becomes difficult to hear.

On this model, it is rectified. The volume is maintained above a certain level even when the volume goes down by using the Expression, in order to keep the sound of high or low frequency audible. The similar function is adopted on most home audio equipments. It is called the “loudness” function.

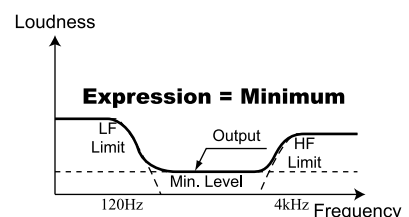
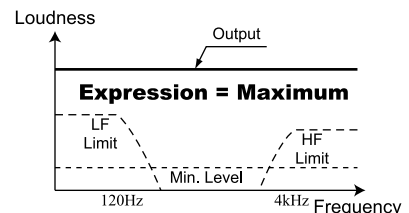

◆ FOOT SWITCH

19. FOOT-SWITCH - TIP (G)

This is used for setting the function for the Foot Switch 1 terminal.

If you are using the Foot Switch with the stereo plug, this sets the function on the tip side.

OFF:

Does not work.

LESLIE S/F ALT:

LESLIE S/F MOM:

These are for switching the SLOW/FAST Leslie Effect.

At ALT, it switches at each press and, at MOM, the Leslie effect goes Fast, as long as you keep pressing the foot switch, and it goes slower Slow if you release it.

DAMPER UPPER:

DAMPER LOWER:

DAMPER PEDAL:

They sustain the Notes of the UPPER, LOWER and PEDAL Parts, respectively, as long as you keep depressing the footswitch.

PATCH FWD:

PATCH REV:

They are for switching one Patch to the right (FWD) or the left (REV).

SPRING:

This is for producing a sound of the old Spring Reverb.

DELAY TIME:

It sets the delay time of the reverb effect (P. 67) along the kicked intervals.

20. FOOT-SWITCH - RING (G)

This is for setting the function on the RING side if you use the FOOT SWITCH equipped with the Stereo plug.

◆ DISPLAY

21. DISPLAY - SHORT CUT (G)

It sets the time limit in seconds for the short cut function.

The range is 1s to 2s and NO short cut. The short cut function does not work when the value is in "NO".

22. DISPLAY - TIME OUT (G)

It sets the time limit to return to the previous mode from the one displayed by using the short cut operation.

The range is 4s to 16s and NO time out. The time out function does not work when the value is in "NO".

tips DAMPER

The word "Damper" comes from the damper pedal of the piano.

The piano stops sounding when you release your finger from the key. This is because of the damper system. While you hold the damper pedal, the system does not work and so it keeps sounding even after you release the key.

tips SPRING REVERB

The Spring Reverb is a reverb effect to obtain the reverberation using the spring resilience. It was easily affected by a shock and it used to give a big "clang" if it was bumped.

However, this drawback has come to be used as an effect in the genre of progressive rock. This module gives the simulated sound.

tips TIP AND RING

When you look at the plug of the stereo headphones, there are 3 metal parts. The head portion is called "Tip" and the middle portion is the "Ring". The part on the cord side is called the "Sleeve". The ordinary foot-switch has only the Tip and the Sleeve, but the footswitch with two switches in one plug or two footswitches using the L/R converting cable can be connected.

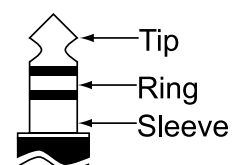

NOTE: The parameters by the names with (P) on the tail are Patch Parameters, and are recorded to each Patch. (G) is for "Global". These parameters will be recorded when set, and are common in each Patch.

ADJUSTING THE EXPRESSION PEDAL

When you use the Expression Pedal V-20R, we suggest you follow the adjusting procedure as shown below.

1

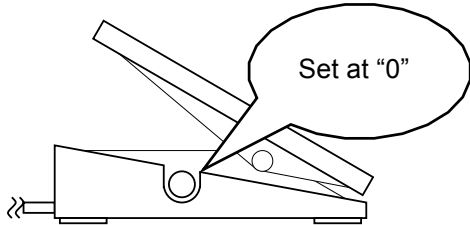

Plug-in the Expression Pedal V-20R to this module, and set the Minimum Volume at Zero.

2

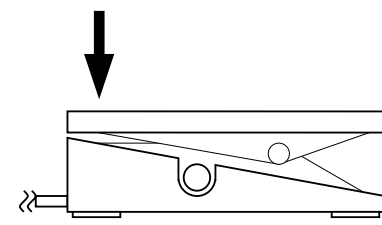

Fully depress the toe side of the Expression Pedal.

3

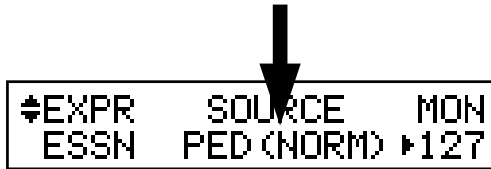

Set the Expression - Source (13) at "PED (NORM)".

4

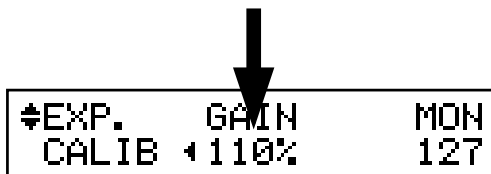

Adjust the Expression - Gain (18) to the Minimum Value where the Monitor (14) displays "127".

5

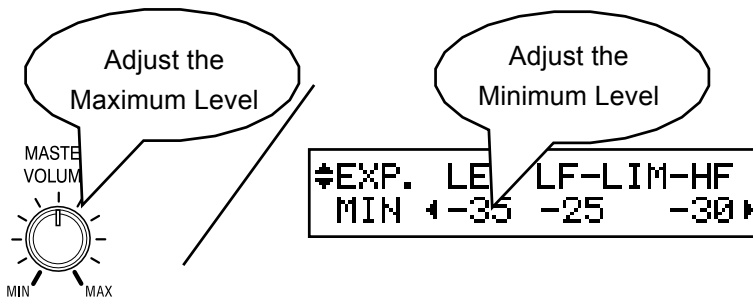

Set the Maximum Level you want when you fully depress the toe side of the Expression Pedal by the Master Volume knob, and also by the Minimum Level (15) you want when you depress the heel side as well.

6

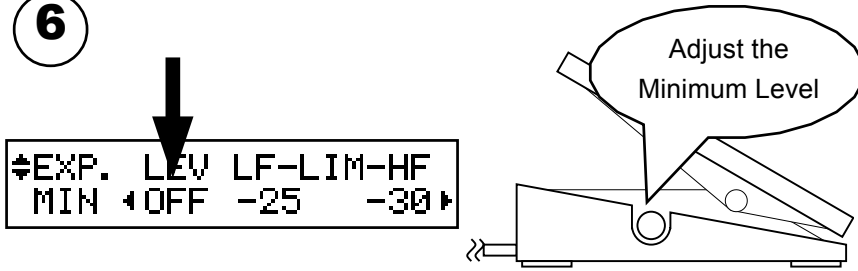

An alternative way for setting the Minimum Level:

Set the Expression - Minimum Level (15) at "OFF", adjusting the Minimum Volume on the Expression Pedal V-20R.

In this mode, you can tune and transpose for playing in ensemble with the other instruments.

To locate this mode:

Touch the [MENU/EXIT] button. The MENU appears. Select PAGE A by the [PAGE] button, and choose the "TUNE" by the [PARAM] button, then touch the [ENTER].



TUNE XPOSE MASTER
MAST ①+0 ②A=440

1. TRANSPOSE

You can transpose the entire keyboard in semi-tone increments.

The setting range is -6 to +6.

Transpose effects between MIDI IN and the built-in sound engine.

2. MASTER TUNE

This is for changing the pitch of this entire keyboard.

The setting range is A = 430 - 450 Hz.

NOTE: The parameters in this mode are the Global Parameters. They are recorded when the value is set. Also, they are common at each Patch.

In this mode, you can select and regulate the Tone-Wheel Sets for the Manual Keyboard parts (LOWER and UPPER).

We call this “CUSTOM TONEWHEELS”.

The typical 3 (or 4) types of settings are recorded when delivered from the factory.

To locate this mode:

Touch the [MENU/EXIT] button and display the MENU, select PAGE B by the [PAGE] button, and then choose “B-type”, “Mellow”, or “Brite” by the [PARAM] button for the desired Tonewheel Set and touch the [ENTER] button.

In addition, the Temporary (= the present setting) automatically switches to the selected Tone-Wheel Set just selected now.



1. CUSTOM NUMBER

This is for selecting the “CUSTOM NUMBER” to use.

Each Custom Number has wheel-by-wheel parameters such as “Level”, “Cut Off Frequency” etc.

NOTE: This parameter is a Global Parameter. It is common for the same Tone-wheel Set (= “B-type” here) of each Patch.

NOTE: You can not edit the wheel-by-wheel parameters on this model.

B-Type

Real B-3

This template faithfully simulates the classic model B-3. It contains low motor hum and some leakage noise.

80's Clean

This template simulates the B-3 sounds in the 80's. It contains reduced leakage noise.

Noisy

This template is for passing all sounds of the picked-up signal. It contains full motor hum and leakage noise.

Noisy 60

This template boosts noises. It contains full motor hum and leakage noise.

Mellow

Full Flats

This template simulates the most ideal tone-wheel set. Their values are same at each wheel.

Husky

This template has the characteristic of dropped middle range.

Flute Lead

This has the characteristic of dropped bass and treble, contrasting “Husky”.

Brite

Classic X-5

This template faithfully simulates the classic model X-5. It contains dull triangle waveform and flat output levels on every wheel.

Voxy Full

This template has the most bright sounds. It is suitable for surfen' music.

Cheap Tr.s

This template simulates old transistor organs. It contains insufficient bass and treble.

tips LEAKAGE NOISE

On the B-3/C-3, the signal leaks in the route from the pick-up mounted for the Tonewheels to the output terminal. Thus noise (= mixed Tone-wheel sound) was also heard. This is called “Leakage Noise”.

The “Leakage Noise” is an obstacle in making pure tones, but it is recognized as a character now.

“Mellow” and “Brite” does not include the “Leakage Noise”.

In this mode, you can set the parameter of the PERCUSSION sound.

To locate this mode:

1. Touch the [MENU/EXIT] button and display the MENU, then select PAGE B by the [PAGE] button, choose "PERCUSS" by using the [PARAM] button and touch [ENTER] button.
2. Another option is to hold down the [PERC.] button for a certain length of time.

▼PERC	1' CANCEL	LEVEL	
DRAWBAR	8 ON	9 -3dB	
↕PERC	TOUCH	VEL KTRK	
KBD	5 ON	6 OF	7 ON
↕PERC	SLOW	FAST	
DECAY	3 8	4 3	
▲PERC	SOFT	NORM	
LEVEL	1 6	2 12	

1. LEVEL - SOFT

2. LEVEL - NORMAL

These are used for setting the Level of Percussion. SOFT is the level when the VOL (P. 36) is SFT, and NORMAL is the level when the VOL is NOR.

3. DECAY - SLOW

4. DECAY - FAST

These are used for setting the speed of the Decay of the Percussion.

SLOW is the speed when the DCY (P. 36) is SLW, and FAST is the speed when the DCY button is FST.

The setting range is 1 - 9 and C. The larger the value gets, the longer gets the Decay Time. At C, no decay (= continuous).

5. KEYBOARD - TOUCH

This is used for setting the method of sound production of the Percussion.

ON: If you play legato, the notes including and after the second note do not sound. (The envelope will not be reset.)

OF: Even if you play legato, all the notes produce sounds like the piano.

6. KEYBOARD - VELOCITY

Controls the Volume of Percussion with Key Velocity.

ON: The faster a key is pressed, the louder the sound.

OF: It sounds at a certain volume regardless of how fast a key is pressed.

7. KEYBOARD - KEY TRACK

Changes the Percussion Volume by the note.

ON: The higher notes reduce the volume.

OF: It sounds at a certain volume regardless of notes.

8. DRAWBAR - 1' CANCEL

This mutes the 1' of the UPPER part while using PERCUSSION.

ON: Mute

OF: Does not mute.

9. DRAWBAR - LEVEL

Decreases the volume of the UPPER Drawbars while using PERCUSSION.

-3dB: Decreases the volume

0dB: Does not decrease the volume

NOTE: This parameter works only when the VOL is SFT.

NOTE: The parameters in those modes are all Patch Parameters. They are recorded to each Patch.

tips TOUCH

The B-3/C-3 had only one built-in Envelope Generator, and was not recharged until all the UPPER Manuals were released. This looks like a drawback, but it had the advantage that the sound did not get loose when chords were roughly played.

tips 1' CANCEL

The B-3/C-3 had no key contact exclusive for percussion but uses the 1' contact for percussion. In this module, this is simulated.

tips DRAWBAR LEVEL

On the B-3/C-3, the Drawbar Volume gets slightly smaller if the Percussion is on. This is simulated in this module.

In this mode, you can create your own settings for the built-in Leslie effects.

There are many parameters for the built-in Leslie effects, and so you can create various settings but not per each Patch independently.

The parameters are treated by the group called "CABINET". You can select the CABINET NUMBER in the Patches.

▼MIC	ANGLE	DISTANCE																
	16	150°	17	0.6m														
♣BASS	SLOW	FAST	LEV	♣BASS	RISE	FALL	BRAK											
SPD	10	48	11	435	12	0	▶	TIME	13	7	14	5	15	10	▶			
♣HORN	SLOW	FAST	LEV	♣HORN	RISE	FALL	BRAK	♣HORN	CHARACTER									
SPD	3	48	4	435	5	-12	▶	TIME	6	2.2	7	1	8	1.2	▶	TYPE	9	MID
♣CAB. NAME																		
2	47-Type																	
▲LESLIE CABINET																		
1	1:147-Type																	

◆CABINET NUMBERS

1. LESLIE CABINETS

Here you select the Cabinet Number to use in the Patches.

The setting range is 1 - 8. The "*" will be displayed when the Leslie Parameters are changed from this Cabinet Number.

◆LESLIE PARAMETERS

2. CABINET NAME

This is for selecting the Cabinet Names.

Move the cursor by the [PARAMETER] button and select letters by the [VALUE].

In this mode, only the present value "Temporary" changes and there is no determining operation. You must record the name by doing "Recording the Cabinet" as explained in the next paragraph. Otherwise the data will be lost.

3. SLOW SPEED - HORN

10. SLOW SPEED - BASS

Here the Speed of the Rotor is set for Slow Speed.

The setting range is 0, 24 - 318 rpm. It does not rotate at 0.

4. FAST SPEED - HORN

11. FAST SPEED - BASS

Here the Speed of the Rotor is set for Fast mode.

The setting range is 0, 375 - 453 rpm. It does not rotate at 0.

To locate this mode:

1. Touch the [MENU/EXIT] button to display the MENU. Then select PAGE C by the [PAGE] button, select LESLIE by the [PARAM] button, and touch [ENTER].
2. Another option is to hold down [LESLIE] button.

tips

CONCEPT OF THE CABINET NUMBERS

Each Cabinet represents one imaginary Leslie Speaker prepared by the Leslie Parameter.

This parameter is the only Patch Parameter in this mode.

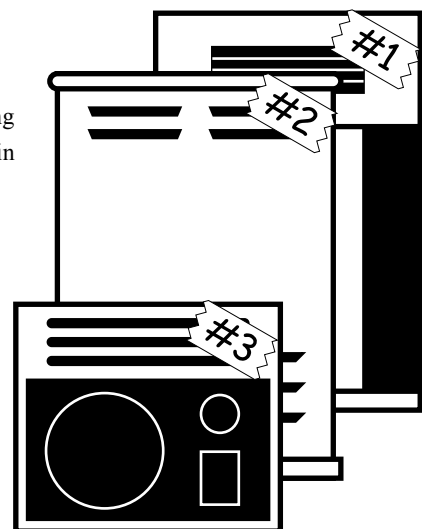

5. HORN LEVEL

12. BASS LEVEL

The Volume of each Rotor is set. The setting range is 0 to -12dB.

6. RISE TIME - HORN

13. RISE TIME - BASS

Here the time is set for the Rotor to reach the Fast Speed when you go from Slow or Brake to Fast. The setting range for the Horn Rotor is 0.2 - 5.0s, and that for the Bass Rotor is 0.5 - 12.5s.

7. FALL TIME - HORN

14. FALL TIME - BASS

Here the Time is set for the Rotor to reach the Slow speed when you go from Fast to Slow Speed. The setting range for the Horn Rotor is 0.2 - 5.0s, and that for the Bass Rotor is 0.5 - 12.5s.

8. BRAKE TIME - HORN

15. BRAKE TIME - BASS

Here the time is set for the Rotor to stop when you go from Fast state to Brake. The setting range for the Horn Rotor is 0.2 - 5.0s, and that for the Bass Rotor is 0.5 - 12.5s.

9. HORN CHARACTER

Here the tone of the Horn Rotor is set.

“FLAT” is a flat tone, and the others are the tones with “peaky” characteristic.

16. MIC - ANGLE

This is the parameter to set for the LOCATIONS of the two Microphones for the imaginary Leslie Speaker.

The ANGLE decides the distance between the two mikes.

The setting range is 0 - 180 degrees. The farther away, the more stereophonic feeling it gives.

17. MIC - DISTANCE

This is the parameter to set for the DISTANCE between the imaginary Leslie Speaker and the Microphones.

The setting range is 0.3 - 2.7m. The more the value increases, the less effective it gets.

NOTE: When you operate the parameters 2 - 17, the setting range will be lost after the power is switched off, if you do not do the recording operation of the next page.

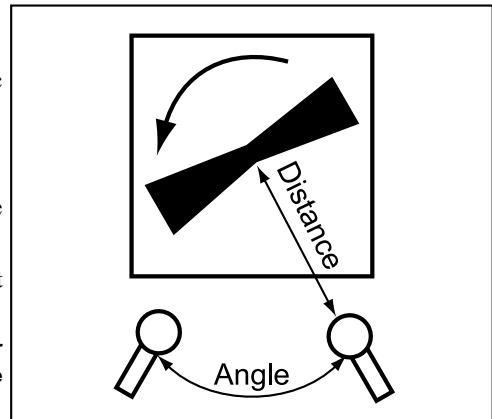
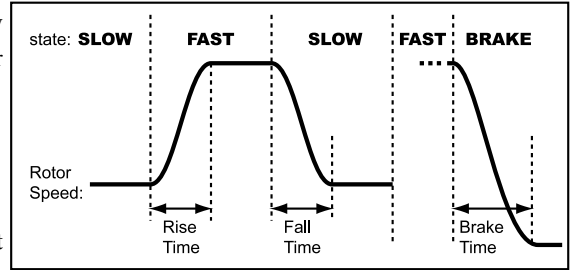

RECORD THE CABINETS

The Leslie parameters (2 - 17 of the previous paragraph) can be recorded with the Cabinet Numbers, and you can choose and use them in each Patch.



Enter the name for the Cabinet as you want.

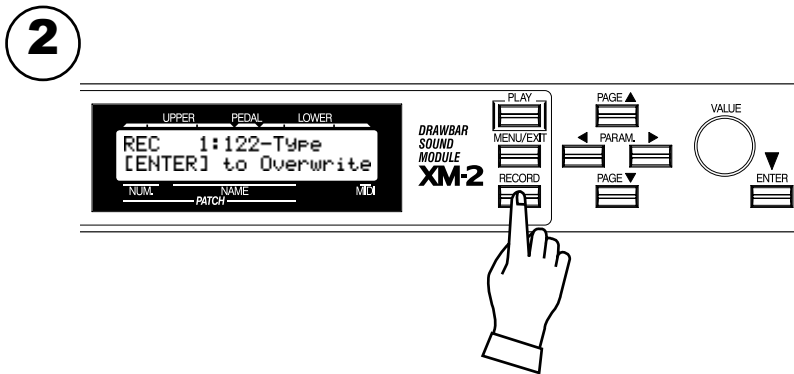

Touch the [RECORD] button in the setting mode of the Leslie Parameter.

The Cabinet Selection mode is displayed.

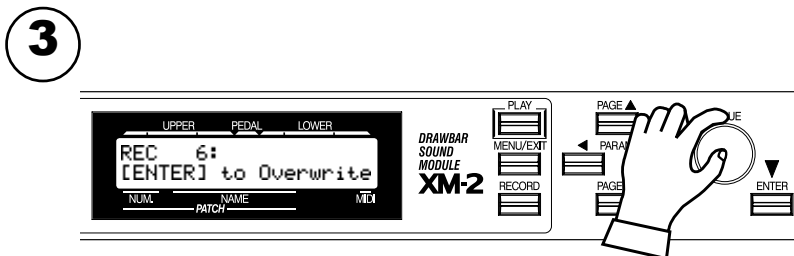

Select the Cabinet Number to record by use of the [VALUE] knob.

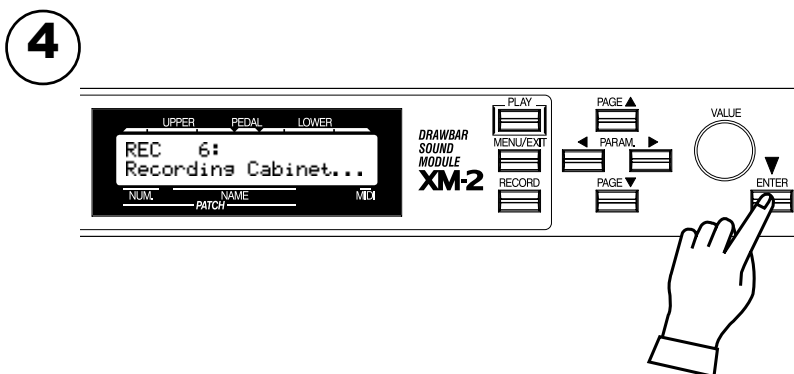

Touch [ENTER] and it is recorded.

The display during the recording treatment is shown in the illustration.

NOTE: If you do not want to record, just touch the [MENU/EXIT].

In this mode, you can change the setting relating to each Effect for Overdrive and Vibrato/Chorus.

To locate this mode:

Touch the [MENU/EXIT] button to display the MENU, select PAGE C by the [PAGE] button, choose "OD/VIB" by the [PARAM] button, and then touch the [1] OD/VIB button.

▾VIB V1 V2 V3 DEPTH 713 810 914	▾VIB C1 C2 C3 DEPTH 108 1111 1214
▴VIB RATE TREM V&C 45.83Hz 510	▴VIB EMPHASIS CHO. 69
▴OD DRIVE EXP. 1ON 253 3EX+OD	

◆OVERDRIVE

1. OVERDRIVE - SWITCH

Turn ON/OFF the Overdrive effect.

2. OVERDRIVE - DRIVE

This is for adjusting the Overdrive Value.

The higher the value gets, the more distortion you can get.

3. OVERDRIVE - EXPRESSION

This is for varying the amount of Overdrive by changing the Expression value.

EX→OD:

If you operate the Expression value, not only the volume but also the distortion will be changed.

OD→EX:

The Expression value affects only the volume and not the distortion value.

OD ONLY:

The Expression value affects only the distortion value and not the volume.

◆VIBRATO & CHORUS

4. VIBRATO - RATE

This is for setting the Speed of the Vibrato and Chorus Effect. The setting range is 6.10 - 7.25 Hz.

5. VIBRATO - TREMOLO

This is for setting the Tremolo (amplitude modulation) of the Vibrato and Chorus Effect.

The setting range is 0 - 15.

6. VIBRATO - EMPHASIS

This is for setting the Emphasis (boost the high frequency) of the Chorus Effect (C1/C2/C3).

The setting range is 0 - 9dB.

7. VIBRATO - DEPTH V1

8. VIBRATO - DEPTH V2

9. VIBRATO - DEPTH V3

10. VIBRATO - DEPTH C1

11. VIBRATO - DEPTH C2

12. VIBRATO - DEPTH C3

These are for setting the Depth of each Vibrato and Chorus Effect mode.

The setting range is 0 - 15.

NOTE: The parameters in these modes are Patch Parameters and are recorded to each Patch.

EQUALIZ (EQUALIZER)

In this mode, the Equalizer settings are made.

The Equalizer is an effect for adjusting the tonal quality. The built-in Equalizer in this unit consists of 3 bands. You can divide the whole range from bass to treble into 3 independent ranges and adjust/control each of them individually.

To locate this mode:

Touch the [MENU/EXIT] button to display the MENU, select Page C by [PAGE]. Next, select "EQUALIZ" by [PARAM] button and then touch [ENTER] button.

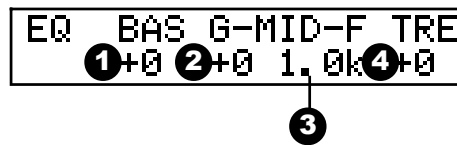

1. EQ BOOST/CUT - BASS
2. EQ BOOST/CUT - MIDDLE
4. EQ BOOST/CUT - TREBLE

This is for changing the Boost/Cut of Bass, Mid-range and Treble respectively. The setting range is -9 to +9. The gain is flat at 0.

3. EQ FREQUENCY - MIDDLE

This is for changing the center frequency range - Middle (item #2). The frequency center range is 480Hz - 2.9kHz.

NOTE: These parameters are Patch Parameters and are recorded to each Patch.

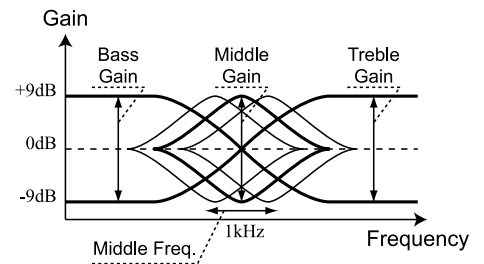

tips

THE EFFECTIVE USE OF THE MIDDLE FREQUENCY

The frequency response of the horn rotor in the Leslie speaker is not flat. It has a peak from 1kHz to 3kHz, The sensitive range for human ears. When you use this module on line out without a Leslie speaker, you can get the similar effect by setting the FREQUENCY - MIDDLE to about 2kHz, and the BOOST/CUT - MIDDLE to "+".

tips PATCH PARAMETERS

Equalizer is a Patch Parameter designed to actively use as one of the tone-making parameters. However, it is not practical to use Equalizer as a tonal complementary tool to match the location. In such a case, if you switch OFF the PLOAD RV/EQ in the PATCH function mode, the Equalizer value does not change when the patch is recalled. (P. 52 #7)

In this mode, you can change the setting for the REVERB EFFECT.

To locate this mode:

Touch the [MENU/EXIT] button for the MENU display, select PAGE C by the [PAGE] button, choose "REVERB" by the [PARAM] button, and touch the [ENTER] button.

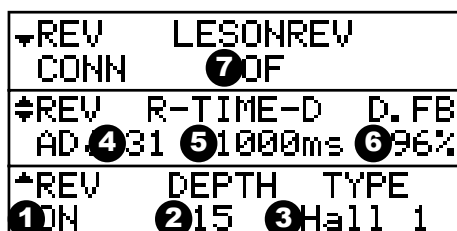

1. REVERB ON

This is for switching ON/OFF the Reverb Effect.

2. DEPTH

This sets the Depth (= Volume) of the Reverb Effect.

The setting range is 0 - 15. If you increase the value, it will give the audience the impression that the player is performing in a larger room.

3. TYPE

This sets the Types of Reverb Effect.

- Room 1: Inside the room (short)
- Room 2: Inside the room (long)
- Live: Live house
- Hall 1: Concert Hall (long)
- Hall 2: Concert Hall (short)
- Church: Church
- Plate: Iron-plate Reverb
- Delay: Delay
- PanDly: Panning Delay
- RevDly: Reverb + Delay

4. REVERB TIME

When the Type (3) is set at Room 1 to Plate, it sets the Time for Reverb to fade out.

The setting range is 0 - 31. The higher the value, the greater the impression of a large building.

5. DELAY TIME

When the Type (3) is set at Delay, PanDly, RevDly, it sets the delaying time.

The setting range is 4.7 - 1000 ms. The higher the number, the longer the delay gets.

NOTE: You can set the Delay Time by the Foot-switch. (P. 57 #19)

6. DELAY FEEDBACK

When the Type (3) is at Delay, PanDly, or RevDly, it sets the amount of the Feedback. (The delaying sound repeats.)

The setting range is 0 - 96%. The higher the value, the higher the Feedback you get.

7. LESLIE ON REVERB

This sets the route of the Reverb and Leslie Effect.

- OF: Leslie to Reverb
- ON: Reverb to Leslie

NOTE: These parameters are Patch Parameters and are recorded to each Patch.

tips PATCH PARAMETERS

Reverb is a Patch Parameter, designed to be actively used as one of the tone-making parameters.

However, it is not practical to use Reverb as a tonal complementary tool to match the room/stage/hall. In such a case, if you switch off the PLOAD RV/EQ in the Patch function mode, the Reverb On/Off value does not change when the patch is recalled. (P. 52 #7)

This mode is for making the basic settings for the MIDI.

To locate this mode:

Touch the [MENU/EXIT] button to display the MENU, select PAGE D by the [PAGE] button. Then select "MIDI" by the [PARAM] button and touch the [ENTER] button.

↙CH UPPER LOWER PEDL ①1 ②2 ③3	↕MAST IN1 IN2 XMC MIDI IN ② SNG ③ CH ④ SNG ▶	↕MAST PROG REGI NRPN Tx&Rx ⑤ ON ⑥ ON ⑦ ON ▶	↕MAST Tx. LES Rx. DUMP ⑧ XM ⑨ ON ▶
▲TEMPLATE ① Single KBD ▶[ENT]	▲TEMPLATE ② KBD for L&U ▶[ENT]	▲TEMPLATE ③ By Channel ▶[ENT]	

◆MIDI TEMPLATE

1. MIDI TEMPLATE

This mode is used for easily making the purpose-by-purpose settings for each MIDI terminal.
Call out a typical settings by selecting the purposes by the [PARAM] button and touching the [ENTER] button.

For example, select "2/3KBD via XMc" if you want to play a full-manual organ using the Drawbar Controller XMc-2 (= optional) and multiple MIDI Keyboards.

NOTE: The MIDI Template is a function for setting the following modes (2 to 4) by one step. Read the details for each MIDI Template in the page 70.

◆MASTER

2. 3. 4. MIDI IN MODE

This is for setting the functions of each MIDI IN terminal.

IN1 and IN2 set the functions for the MIDI IN 1 and 2 respectively on this unit, and the XMc sets that of the MIDI IN of the XMc-2 connected to this unit.

For example, set the Parameter IN2 to PED if you want to play the PEDAL part by the MIDI message received at the MIDI IN2 terminal.

NOTE: Read the page 70 for the details of each MIDI IN mode.

5. PROGRAM CHANGE

This is for switching ON/OFF the transmission of the Program Change.

Use the Program Change for switching the Combination Presets on this unit.

ON: Transmit. OF: Don't transmit

6. REGISTRATION

This is for switching ON/OFF the transmission of the Drawbar Registration.

ON: Transmit. OF: Don't transmit.

7. NRPN

This is for switching ON/OFF the NRPN (= Non-Registered Parameter Number) transmission.

On this unit, it switches ON/OFF the message transmission such as the Drawbar Foldback and the Leslie ON.

ON: Transmit. OF: Don't transmit.

```

◆MAST  10SEND DUMP
↓[ENTER] to Proceed
◆TEMPLATE
↓2/3KBD via XMc[ENT]

```

8. LESLIE

This is used for switching the methods of the Leslie Parameter transmission.

XM: The Leslie Parameters are transmitted by the original NRPN and data of the XM-2.

21: The Leslie Parameters are transmitted by the NRPN and data for the Leslie #2101/2102. In addition, when you select the Patch, the Leslie Parameters are transmitted.

9. RECEIVE DUMP

This is for switching ON/OFF the MEMORY DUMP receiving.

On this unit, you can transmit the whole current settings by the System Exclusive Messages as a Memory Dump. However, switch it off if you do not want the settings on this unit changed by playing the Sequencer.

ON: Receive. OF: Don't receive.

10. SEND DUMP

This is for sending the Memory Dump.

Touch the [ENTER] button on this page. All the setting contents of this unit are sent out from the MIDI OUT terminal as a whole.

◆MIDI CHANNEL

11. UPPER

12. LOWER

13. PEDAL

You can set which MIDI channel to use for transmitting each part.

The options are 1 to 16, OF. It does not transmit at OF.

On MIDI IN terminal, this Parameter works when the MIDI IN mode is CH.

NOTE: The settings in these modes are System Parameters. They are recorded at the same time when they are set, and are common in all Patches.

MIDI TEMPLATES AND THEIR PURPOSES

	Single KBD	2KBD for L&U	By Channel	2/3KBD via XMc
XM-2 IN1	SINGLE	UPPER	CHANNEL	LOWER
XM-2 IN2	CHANNEL	LOWER	CHANNEL	PEDAL
XMc-2 IN	SINGLE	UPPER	CHANNEL	UPPER
Description	This template is for the play using the Split and Manual Bass functions of this unit, by connecting a MIDI Keyboard, to be sent by a single channel, to this unit or the Drawbar Controller.	This template is for playing the UPPER and LOWER part respectively on each MIDI Keyboard, by connecting 2 MIDI Keyboards sent by a single channel to this unit.	This template is for the play with a connected MIDI Keyboard, to send out plural MIDI channels to this unit or the Drawbar Controller.	This template is for playing 3 manuals, connecting a MIDI Keyboard to the Drawbar Controller, and another MIDI Keyboard and a MIDI Pedalboard to this unit.

THE MIDI IN MODES AND THEIR FUNCTIONS

	SINGLE	UPPER	LOWER	PEDAL	CHANNEL
PART played	UPPER	UPPER	LOWER	PEDAL	by MIDI channel
SPLIT	Yes	No	No	No	No
MANUAL BASS	Yes	No	Yes	No	No
SOFT-THRU	Yes	Yes	Yes	Yes	No
Description	The note-data received at the port set in this mode basically plays the UPPER part, regardless of the MIDI channels. By using the SPLIT and MANUAL BASS functions, it is possible to play 3 separate parts by a single MIDI Keyboard. The data received is separated into each part inside and runs Soft-Thru the set MIDI channel.	The note-data received at this port set in this mode always plays the UPPER part, regardless of the MIDI channel. It runs Soft-Thru the set MIDI channel.	The note-data received at the port set in this mode always plays the LOWER part, regardless of the MIDI channel. By the Manual Bass function, the PEDAL part can be played at the same time. It runs Soft-Thru the set MIDI channel.	The note-data received at the port set in this mode always plays the PEDAL part, regardless of the MIDI channel. It runs Soft-Thru the set MIDI channel.	The note-data received at the part set in this mode works in accordance with the MIDI channel. It neglects SPLIT or MANUAL BASS, nor runs Soft-Thru, either.

In this mode you can set the zones to play the built-in sound engine in this unit for Split, Manual Bass, etc.

To locate this mode:

Touch the [MENU/EXIT] button to display the MENU, select PAGE D by the [PAGE] button. Then select "KEYMAP" by the [PARAM] button and touch the [ENTER] button.

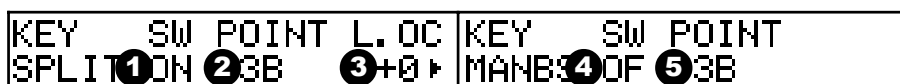

◆ SPLIT

SPLIT functions when the settings of the MIDI IN mode is "SNG".

1. SPLIT - SWITCH

This is for switching ON/OFF the SPLIT function.

If you switch it ON, the received Note Data is divided/distributed to each of the LOWER/UPPER parts at the Split Point (= See below.), which allows you to play both (LOWER/UPPER) parts by a single MIDI Keyboard.

2. SPLIT - POINT

This is for setting the point (= the note) at which to split the LOWER and the UPPER parts, when you use the SPLIT function.

The setting value is the highest note used in the LOWER part.

3. SPLIT - LOWER OCTAVE

This is for setting the pitch of the split LOWER part by the octave.

If you use the SPLIT function, the pitch of the LOWER part may be too low and so may not be suitable for playing chords.

In such a case, you can raise the pitch of the lower octave.

◆ MANUAL BASS

MANUAL BASS functions when the settings of the MIDI IN mode is "SNG" or "LOW".

4. MANUAL BASS - SWITCH

This is for switching ON/OFF the Manual Bass function.

If you switch it ON, the PEDAL part plays by receiving the Note Data in the range upto the Manual Bass Point (= See below.).

Thus you can play both (Manual and Pedal) parts on a single MIDI Keyboard.

NOTE: You can choose POLY (for playing chords) or MONO (sounding only lowest note). (P. 51 #15)

5. MANUAL BASS - POINT

This is for setting the uppermost note where the Manual Bass functions.

◆ WHAT IS SPLIT?

It is a function to divide a single MIDI Keyboard into two separate (right and left) parts (LOWER/UPPER) at a certain note.

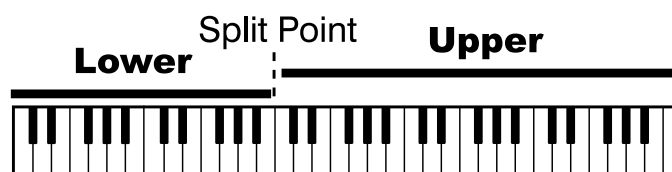

◆ WHAT IS MANUAL BASS?

It is a function to assign a certain range on a single MIDI Keyboard as the LOWER part to allow you to play together with the Manual part at the same time.

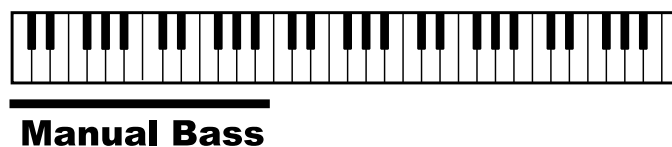

DEFAULT

In this mode, you can initialize the whole or a part of this unit back to the factory settings.

To locate this mode:

Touch the [MENU/EXIT] button to display the MENU, select PAGE D by the [PAGE] button.

Then select "DEFAULT" by the [PARAM] button and touch the [ENTER] button.



To initialize each Parameter, touch the [PARAM] button to choose the Parameter and touch [ENTER].

1. PATCH

This is for Initializing the Patch.

Select the Patch you want to initialize by the [VALUE] knob. The selection range is 1 to 128, ALL (= All Patches).

2. GLOBAL

This is for initializing the Global Parameters such as Master Tune, Foot Switch assignment.

3. LESLIE

This is for initializing the Cabinet(s). Select the Cabinet you want to initialize by the [VALUE] knob.

The selection range is 1 to 8, ALL (= All Cabinets).

4. ALL

This is for initializing all the Parameters of this unit.

If the system of this unit gets unstable unexpectedly, you may cure the trouble by doing DEFAULT ALL.

NOTE: Initializing all Parameters can be made by turning the power on, and holding down the [RECORD] button.

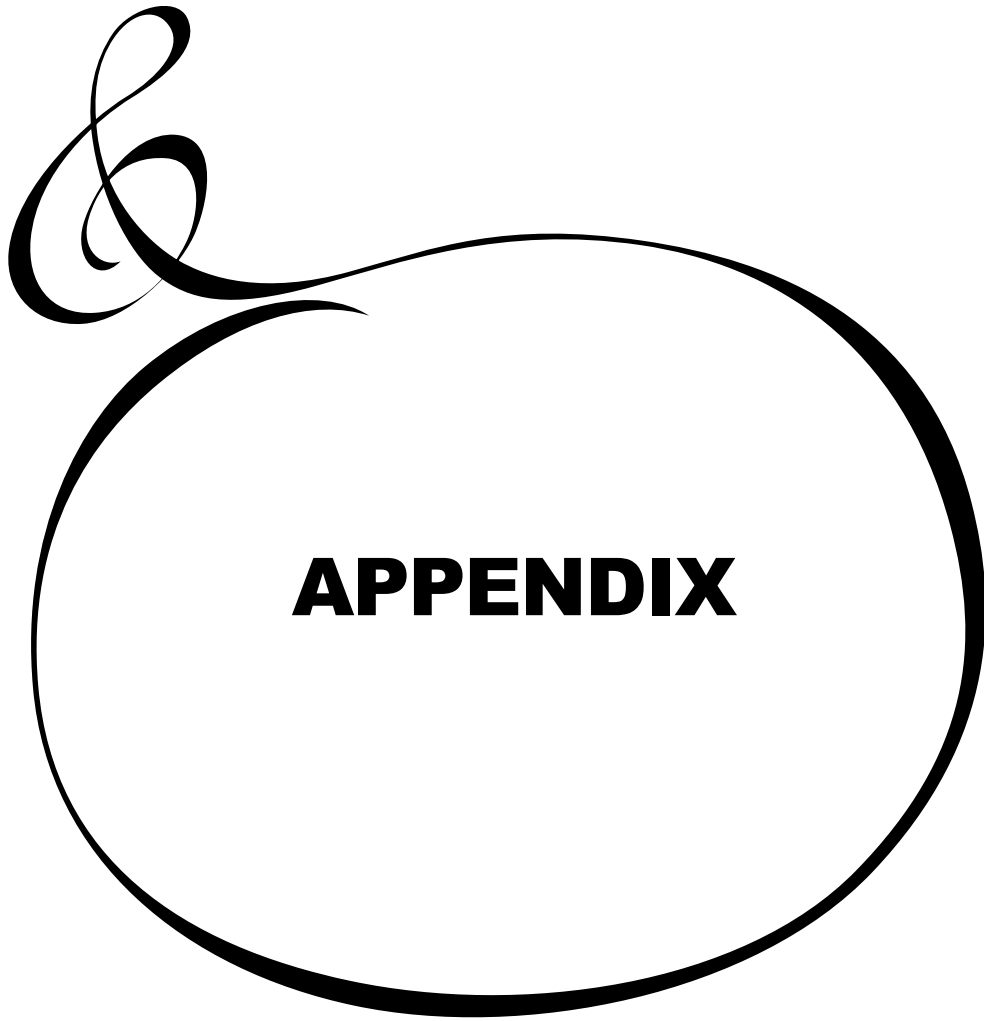

[Drawbar Sound Module]
Model: XM-2

MIDI Implementation Chart

Date: 26-Jun-2006
Version: 1.0

Function		Transmitted	Recognized	Remarks
Basic Channel	Default Changed	1 1 - 16	1 1 - 16	Upper Channel *1
Mode	Default Messages Altered	3 X *****	3 X X	
Note Number	: True Voice	X *****	36 - 96 36 - 96	
Velocity	Note ON Note OFF	O X	O X	
After Touch	Key's Ch's	X X	X O	
Pitch Bender		X	O	
	1	X	O	Modulation
	6, 38	O	O	Data Entry MSB, LSB
	11	O	O	Expression
	12 - 20	X	O	Drawbar Reg. Upper
	21 - 29	X	O	Drawbar Reg. Lower
	33, 35	X	O	Drawbar Reg. Pedal
	48	O	O	Spring Shock
	49, 50, 51	X	O	Leslie On, Brake, Fast
	64	O	O	Hold 1
	80, 81, 82	O	O	Drawbar Reg. U, L, P
	98, 99	O	O	NRPN LSB, MSB
	100, 101	X	X	RPN LSB, MSB
	120	X	O	All Sound Off
	121	X	O	Reset All Controllers
Program Change	: True #	O *****	O O	0 - 127 0 - 127
System Exclusive		O	O	
System Common	: Song Position : Song Select : Tune	X X X	X X X	
System Real Time	: Clock : Commands	X X	X X	
Aux Messages	: Local On/Off : All Notes Off : Active Sense : Reset	X X O X	X O O X	

Mode 1: OMNI ON, POLY

Mode 2: OMNI ON, MONO

O: Yes

Mode 3: OMNI OFF, POLY

Mode 4: OMNI OFF, MONO

X: No

*1: Lower Channel = 2, Pedal Channel = 3

Part and MIDI Messages

	Upper	Lower	Pedal
Note	O	O	O
Pitch Bend	O *1	X	O
Modulation (1)	O	X	X
Volume, Pan (7, 10)	X	X	X
Expression (11)	O *2	X	X
Hold 1 (64)	O	O	O
Drawbar Reg.	CC#80, 12 - 20	CC#81, 21 - 29	CC#82, 33, 35
Spring Shock (48)	O	X	X
RPN (100, 101)	X	X	X
NRPN (98, 99)	O	X	X
All Notes Off (123)	O	O	O
All Sounds Off (120)	O	O	O
Reset All Ctrl. (121)	O	O	O
After Touch	O	X	O *3
Bank Select (0, 32)	X	X	X
Program Change	Patch	Patch (for Lower / Pedal only)	Patch

*1: It works for both Upper and Lower.

*2: It work for all parts (audio controlled).

*3: Pitch Bend only

MIDI Information

[Channel Voice Message]

Note Off

Status	2nd Byte	3rd Byte
8n	kk	vv
9n	kk	00

n=MIDI Channel Number: 0 - F(Ch.1 - 16)
 kk=Note Number: 00 - 7F(0 - 127)
 vv=Velocity(disregard): 00 - 7F(0 - 127)

Note On

Status	2nd Byte	3rd Byte
9n	kk	vv

n=MIDI Channel Number: 0 - F(Ch.1 - 16)
 kk=Note Number: 00 - 7F(0 - 127)
 vv=Velocity: 00 - 7F(0 - 127)

Control Change

The value set by the Control Change is not reset even when Program Change messages etc. are received.

Modulation

Status	2nd Byte	3rd Byte
Bn	01	vv

n=MIDI Channel Number: 0 - F(Ch.1 - 16)
 vv=Modulation Value: 00 - 7F

Expression

Status	2nd Byte	3rd Byte
Bn	0B	vv

n=MIDI Channel Number: 0 - F(Ch.1 - 16)
 vv=Expression Value: 00 - 7F(0 - 127)
 Default Value = 7F(127)

Spring Shock

Status	2nd Byte	3rd Byte
Bn	30	vv

n=MIDI Channel Number: 0 - F(Ch.1 - 16)
 vv=Velocity:

Leslie On

Status	2nd Byte	3rd Byte
Bn	31	vv

n=MIDI Channel Number: 0 - F(Ch.1 - 16)
 vv=Control Value: 00 - 7F(0 - 127) 0-63 = Off, 64-127 = On

Leslie Brake

Status	2nd Byte	3rd Byte
Bn	32	vv

n=MIDI Channel Number: 0 - F(Ch.1 - 16)
 vv=Control Value: 00 - 7F(0 - 127) 0-63 = Off, 64-127 = On

Leslie Fast

Status	2nd Byte	3rd Byte
Bn	33	vv

n=MIDI Channel Number: 0 - F(Ch.1 - 16)
 vv=Control Value: 00 - 7F(0 - 127) 0-63 = Off, 64-127 = On

Hold 1

Status	2nd Byte	3rd Byte
Bn	40	vv

n=MIDI Channel Number: 0 - F(Ch.1 - 16)
 vv=Control Value: 00 - 7F(0 - 127) 0-63 = Off, 64-127 = On

Pitch Bend Change

Status	2nd Byte	3rd Byte
En	ll	mm

n=MIDI Channel Number: 0 - F(Ch.1 - 16)
 mm=Upper Byte
 ll=Lower Byte 00 00(-8192) - 40 00(0) - 7F 7F(8191)

[Channel Mode messages]

All Sounds Off

Status	2nd Byte	3rd Byte
Bn	78	00

n=MIDI Channel Number: 0 - F(Ch.1 - 16)
When this message is received, all currently-sounding notes on the corresponding channel will be turned off immediately.

Reset All Controllers

Status	2nd Byte	3rd Byte
Bn	79	00

n=MIDI Channel Number: 0 - F(Ch.1 - 16)
When this message is received, the following controllers will be set to their reset values.

Controller	Reset Value
Pitch Bend Change	±0 (Center)
Modulation	0 (off)
Expression	127 (Maximum)
Hold 1	0 (off)
RPN	unset; previously set data will not change
NRPN	unset; previously set data will not change

All Notes Off

Status	2nd Byte	3rd Byte
Bn	7B	00

n=MIDI Channel Number: 0 - F(Ch.1 - 16)
When All Notes Off is received, all notes on the corresponding channel will be turned off. However if Hold 1 is On, the sound will be continued until these are turned off.

NRPN MSB/LSB

Status	2nd Byte	3rd Byte
Bn	63	mm
Bn	62	ll

n=MIDI Channel Number: 0 - F(Ch.1 - 16)
 mm=Upper Byte of the Parameter Number designated by NRPN[MSB].
 ll=Lower Byte of same[MSB].
The value set by NRPN is not reset even if "Program Change", "Reset All controllers", etc. are received.

NRPN- "Non Registered Parameter Number"

The expansive range named NRPN is provided in the Control Change, which function is specific on each equipment and not defined in the MIDI Standard.
 When you use it, designate the parameter to control, by giving NRPN MSB and NRPN LSB (cc#98 and 99), and then set the value of the designated parameter by the Data Entry MSB(cc#6).
 Once the NRPN parameter is designated, all the data entry received into the same channel after that is regarded as the change of the value of the parameter. To avoid any mis-operation, we suggest you to set RPN Null (RPN = 7F 7F), after setting the necessary parameter value.
 On this sound module you can change the voice parameter by using NRPN.

Data Entry

Status	2nd Byte	3rd Byte
Bn	06	mm
Bn	26	ll

n=MIDI Channel Number: 0 - F(Ch.1 - 16)
 mm,ll=Value for the Parameter designated by RPN/NRPN.

Drawbar Data List 1

Control number: Upper 50h(80)
 Lower 51h(81)
 Pedal 52h(82)

Data Map:

Level	Upper/Lower								Pedal		
	16'	5 1/3'	8'	4'	2 2/3'	2'	1 3/5'	1 1/3'	1'	16'	8'
0	00h(0)	09h(9)	12h(18)	1Bh(27)	24h(36)	2Dh(45)	36h(54)	3Fh(63)	48h(72)	00h(0)	09h(9)
1	01h(1)	0Ah(10)	13h(19)	1Ch(28)	25h(37)	2Eh(46)	37h(55)	40h(64)	49h(73)	01h(1)	0Ah(10)
2	02h(2)	0Bh(11)	14h(20)	1Dh(29)	26h(38)	2Fh(47)	38h(56)	41h(65)	4Ah(74)	02h(2)	0Bh(11)
3	03h(3)	0Ch(12)	15h(21)	1Eh(30)	27h(39)	30h(48)	39h(57)	42h(66)	4Bh(75)	03h(3)	0Ch(12)
4	04h(4)	0Dh(13)	16h(22)	1Fh(31)	28h(40)	31h(49)	3Ah(58)	43h(67)	4Ch(76)	04h(4)	0Dh(13)
5	05h(5)	0Eh(14)	17h(23)	20h(32)	29h(41)	32h(50)	3Bh(59)	44h(68)	4Dh(77)	05h(5)	0Eh(14)
6	06h(6)	0Fh(15)	18h(24)	21h(33)	2Ah(42)	33h(51)	3Ch(60)	45h(69)	4Eh(78)	06h(6)	0Fh(15)
7	07h(7)	10h(16)	19h(25)	22h(34)	2Bh(43)	34h(52)	3Dh(61)	46h(70)	4Fh(79)	07h(7)	10h(16)
8	08h(8)	11h(17)	1Ah(26)	23h(35)	2Ch(44)	35h(53)	3Eh(62)	47h(71)	50h(80)	08h(8)	11h(17)

ex: Set Lower 8' to level 7 via MIDI...

Bx 51 19

(x=Lower Channel)

Drawbar Data List 2

Data Map:

Part	Control Number								
	16'	5 1/3'	8'	4'	2 2/3'	2'	1 3/5'	1 1/3'	1'
Upper	0Ch(12)	0Dh(13)	0Eh(14)	0Fh(15)	10h(16)	11h(17)	12h(18)	13h(19)	14h(20)
Lower	15h(21)	16h(22)	17h(23)	18h(24)	19h(25)	1Ah(26)	1Bh(27)	1Ch(28)	1Dh(29)
Pedal	21h(33)	-	23h(35)	-	-	-	-	-	-

Value	Level								
	0	1	2	3	4	5	6	7	8
	00 - 0Fh 0 - 15	10 - 1Fh 16 - 31	20 - 2Fh 32 - 47	30 - 3Fh 48 - 63	40 - 4Fh 64 - 79	50 - 5Fh 80 - 95	60 - 6Fh 96 - 111	70 - 7Eh 112 - 126	7Fh 127

ex: Set Lower 8' to level 7 via MIDI...

Bx 17 70

(x=Upper Channel)

System Exclusive Message

Memory Dump

1. Each Packet

F0	System Exclusive
55	SUZUKI ID
00	Device ID
10	Model ID MSB
16	Model ID LSB
11	Command: Data Packet
[TYPE]	Data Type 02h= Setup Dump
[PNH]	Packet Number MSB
[PNL]	Packet Number LSB
[DATA]	64 Bytes Data 128 Bytes nibblized ASCII ex: 7Eh = 37h, 45h
[CHD]	Check Digit Lower 7 bits of XOR [DATA]
F7	End of Exclusive

2. Acknowledge

F0	System Exclusive
55	SUZUKI ID
00	Device ID
10	Model ID MSB
16	Model ID LSB
14	Command: Acknowledge
[AK]	Result: 00h=OK 05h=Check Digit Error 06h=Receive Protected
[PNH]	Packet Number MSB
[PNL]	Packet Number LSB
F7	End of Exclusive

3. Hand shake communication

Master	Slave
Packet 0	->
	<- Acknowledge 0
Packet 1	->
	<- Acknowledge 1

This device will wait for 20ms if no acknowledge is received and transmit the next data of the packet number. (One Way Transfer)

NRPN Switch

F0	System Exclusive
55	SUZUKI ID
00	Device ID
10	Model ID MSB
16	Model ID LSB
02	Command: NRPN Sw.
[DATA]	00h=Off, 7Fh=On
F7	End Of Exclusive

When this device receives this message, switch Tx&Rx NRPN in Control channel.

Mode Setting Exclusive Message

Full Parameters Reset

F0	System Exclusive
55	SUZUKI ID
10	Device ID for DT1
42	Model ID for DT1
12	Command: DT1
40	Address MSB
00	Address
7F	Address LSB
7F	Reset
42	Check Sum
F7	End of Exclusive

When this device receives this message, it is reset to the initial status of Full Parameter, and gets ready for receiving the music data for this device correctly.

It takes about 50ms to process this message. Take an interval before the next message.

Global Parameters

Category	Global Parameters					
	Parameter	NRPN		DATA MSB (06)	Default	Description
		LSB (62)	MSB (63)			
Tune	Transpose	01	00	3A - 40 - 46 (-6 - 0 - 6)	40	0
	Master Tune	01	02	032E - 0338 - 0342 (430 - 440 - 450)	0338	440
Expression	Source	02	00	00 - 02 00: Exp. Pedal (Normal) 01: Exp. Pedal (Reverse) 02: MIDI IN	02	MIDI IN
	Min. Level	02	08	00 - 0D	06	-35dB
	Min. Limit LF	02	09	(Off, -60dB - -0dB)	09	-20dB
	Min. Limit HF	02	0A		07	-30dB
Foot Switch	Mode Tip	02	02	00 - 09 00: Off 01: Leslie Fast(alternate) 02: Leslie Fast(momentarily)	01	Leslie Fast (alternate)
	Mode Ring	02	03	03: Damper Upper 04: Damper Lower 05: Damper Pedal 06: Patch Fwd. 07: Patch Rev. 08: Spring Shock 09: Delay Time	01	Leslie Fast (alternate)
XMc Preset	Preset 1	02	0B	00 - 7F (1 - 128)	00	same as button #
	Preset 2	02	0C		01	
	Preset 3	02	0D		02	
	Preset 4	02	0E		03	
	Preset 5	02	0F		04	
Tone- Wheel set	B-Type	03	00	00 - 03	00	Real B-3
	Mellow	03	01	00 - 02	00	Full Flats
	Brite	03	02	00 - 02	00	Classic X-5
Combi. Preset Load	Link Lower/Pedal(Link L/P)	50	00	00, 01 (Off/On)	01	On
	Upper Regist. (UK)	50	01	00, 01 (Off/On)	01	On
	Split, ManBs (INT)	50	02	00, 01 (Off/On)	01	On
	Reverb, Equalizer (RV/EQ)	50	03	00, 01 (Off/On)	01	On
	Leslie, Vibrato (ANI/OD)	50	04	00, 01 (Off/On)	01	On
	Drawbar (DRAWB)	50	05	00, 01 (Off/On)	01	On
	Percussion (PERCUS)	50	06	00, 01 (Off/On)	01	On

Patch Parameters

Category	Patch Parameters					
	Parameter	NRPN		DATA MSB (06)	P. load	
		LSB (62)	MSB (63)			
Name	10 Characters				always	
Drawbar Effect	Leslie On	09	00	00, 01 (Off/On)	ANI/OD	
	Leslie Fast	09	01	00, 01 (Slow/Fast)		
	Leslie Brake	09	06	00, 01 (Through / Brake)		
	Leslie Cabinet	09	07	00 - 07 (1 - 8)		
	Leslie Mod. Ctrl	09	08	00 - 02 (Off, Speed, S/F)		
	Leslie Press. Ctrl	09	0A	00 - 02 (Off, Speed, S/F)		
	Vibrato Mode	09	02	00 - 03 (Off, 1 - 3)		ANI/OD
	Vibrato / Chorus	09	03	00 - 01		
	Vibrato Rate	09	04	00 - 04 (6.1 - 7.25Hz)		
	Vibrato Tremolo	09	15	00 - 0F (0 - 15)		
	Vibrato Cho. Emphasis	09	16	00 - 09 (0 - 9)		
	Vibrato Depth V1	09	0F	00 - 0F (0 - 15)		
	Vibrato Depth V2	09	10	00 - 0F (0 - 15)		
	Vibrato Depth V3	09	11	00 - 0F (0 - 15)		
	Vibrato Depth C1	09	12	00 - 0F (0 - 15)		
	Vibrato Depth C2	09	13	00 - 0F (0 - 15)		
	Vibrato Depth C3	09	14	00 - 0F (0 - 15)		
	OD On	09	09	00, 01 (Off/On)	ANI/OD	
	OD Drive Level Master	09	05	00 - 3F (0 - 63)		
	OD Exp. Ctrl	09	0C	00 - 02 00: OD to Exp 01: Exp to OD 02: OD Only		
	OD Mod. Ctrl	09	0D	00, 01 (Off/On)		
	OD Press. Ctrl	09	0E	00, 01 (Off/On)		
	Bend Press. Ctrl	09	17	00 - 02 (Off, Down, Up)	ANI/OD	
	EQ Bass Gain	0A	00	00 - 09 - 12 (-9 - 0 - +9 dB)	EQ/REV	
	EQ Mid Gain	0A	01	00 - 09 - 12 (-9 - 0 - +9 dB)		
	EQ Treble Gain	0A	02	00 - 09 - 12 (-9 - 0 - +9 dB)		
	EQ Mid Freq	0A	03	00 - 0A (480 - 2.9kHz)		
	Reverb On	0A	04	00, 01 (Off/On)	EQ/REV	
	Reverb Type	0A	05	00 - 09 00: Room 1 01: Room 2 02: Live House 03: Hall 1 04: Hall 2 05: Church 06: Plate 07: Delay 08: Panning Delay 09: Reverb + Delay		
	Reverb Depth	0A	06	00 - 0F (0 - 15)		
Reverb Time	0A	07	00 - 1F (0 - 31)			
Reverb Delay Feedback	0A	08	00 - 1F (0 - 96%)			
Reverb Delay Time	0A	09	00 - 3F (4.7 - 1000ms)			
Leslie On Reverb	0A	0A	00, 01 (Off/On)			

Category	Patch Parameters				
	Parameter	NRPN		DATA MSB (06)	P. load
		LSB (62)	MSB (63)		
Internal Zone	Split On	07	00	00, 01 (Off/On)	SPLIT & MANBS
	Manual Bass On	07	01	00, 01 (Off/On)	
	Pedal Key Range High	07	04	24 - 60	
	Split Point	07	05	24 - 5F	
	Split Lower Octave	07	06	00, 01 (0, +1)	

Category	Patch Parameters				
	Parameter	NRPN		DATA MSB (06)	P. load
		LSB (62)	MSB (63)		
Upper/ Lower Drawbar Voice	Voice Type	20	00	00 - 02 00: B-Type 01: Mellow 02: Brite	DRAWB
	Drawbar Click Attack	20	01	00 - 0F (0 - 15)	
	Drawbar Click Release	20	02	00 - 0F (0 - 15)	
	Drawbar Env. Attack	20	03	00 - 0F (0 - 15)	
	Drawbar Env. Release	20	04	00 - 0F (0 - 15)	
	Fold Back Low	20	05	00 - 0C (C1 - C2)	
	Fold Back High	20	06	2B - 30 (G4 - C5)	
	Bend Range Down	20	07	00 - 18 (0 - 24)	
	Bend Range Up	20	08	00 - 0C (0 - 12)	
	Bend Mode	20	0A	00 - 01 (Bend / Motor)	
	Bend Time	20	0B	00 - 31 (0.1 - 5.0s)	
	Bend Amplitude	20	0C	00 - 01 (Off/On)	
	Drawbar Click LPF	20	09	00 - 7F (0 - 127)	
	Percussion Voice	Second On	08	00	
Third On		08	01	00, 01 (Off/On)	
Decay Fast		08	02	00, 01 (Off/On)	
Soft		08	03	00, 01 (Off/On)	
Level Soft		08	04	00 - 0F (1 - 16)	
Level Normal		08	05	00 - 0F (1 - 16)	
Decay Fast		08	06	00 - 09 (1 - 9, C)	
Decay Slow		08	07	00 - 09 (1 - 9, C)	
Touch		08	08	00, 01 (Off/On)	
Velocity		08	09	00, 01 (Off/On)	
Key Track		08	0A	00, 01 (Off/On)	
Drawbar 1' Cancel		08	0B	00, 01 (Off/On)	
Drawbar Level		08	0C	00, 01 (0, -3dB)	
Upper Drawbars		16'	see Drawbar Data List for details		
	5 1/3'				
	8'				
	4'				
	2 2/3'				
	2'				
	1 3/5'				
	1 1/3'				
	1'				

Category	Lower Patch Parameters						
	Parameter	NRPN		DATA MSB (06)	P. load		
		LSB (62)	MSB (63)				
Lower Drawbars	16'	see Drawbar Data List for details			Link L/P		
	5 1/3'						
	8'						
	4'						
	2 2/3'						
	2'						
	1 3/5'						
	1 1/3'						
Pedal Drawbar Voice	Voice Type	22	00	00 - 03 00: Normal 01: Muted 02: Synth 1 03: Synth 2	Link L/P		
	Drawbar Attack	22	01	00 - 04 00: Slow Attack 01: No Click 02: Soft Click 03: Normal Click 04: Max Click			
	Bend Range Down	22	02	00 - 18 (0 - 24)			
	Bend Range Up	22	03	00 - 0C (0 - 12)			
	Sustain On	22	04	00, 01 (Off/On)			
	Sustain Length	22	05	00 - 04 (1 - 5)			
	Pedal Key Mode	22	06	00, 01 (Mono/Poly)			
	Decay Length	22	07	00 - 05 (1 - 5, Cont.)			
	Velocity	22	08	00 - 04 (Off, 1 - 4)			
	Pedal Drawbars	16'	see Drawbar Data List for details			Link L/P	
		8'					

Leslie Parameters

Category	Leslie Parameters						
	Parameter	NRPN on XM		NRPN on 21		DATA MSB (06)	Default
		LSB (62)	MSB (63)	LSB (62)	MSB (63)		
Cabinet #1 - 8	Name					(10 Characters)	
	Slow Speed Horn	06	00	7F	00	00 - 63(0, 24 - 318rpm)	05 (36rpm)
	Slow Speed Bass	06	01	7F	01	00 - 63(0, 24 - 318rpm)	05 (36rpm)
	Fast Speed Horn	06	02	7F	02	00 - 1B(0, 375 - 453rpm)	07 (393rpm)
	Fast Speed Bass	06	03	7F	03	00 - 1B(0, 375 - 453rpm)	07 (393rpm)
	Rise Time Horn	06	04	7F	04	00 - 18(0.2 - 5.0s)	0A (2.2s)
	Rise Time Bass	06	05	7F	05	00 - 18(0.5 - 12.5s)	0D (7.0s)
	Fall Time Horn	06	06	7F	06	00 - 18(0.2 - 5.0s)	04 (1.0s)
	Fall Time Bass	06	07	7F	07	00 - 18(0.5 - 12.5s)	09 (5.0s)
	Brake Time Horn	06	08	7F	08	00 - 18(0.2 - 5.0s)	05 (1.2s)
	Brake Time Bass	06	09	7F	09	00 - 18(0.5 - 12.5s)	13 (10s)
	Volume Horn	06	0A	--	--	00 - 0C(-12 - 0dB)	0C (0dB)
	Volume Bass	06	0B	--	--	00 - 0C(-12 - 0dB)	0C (0dB)
	Mic. Angle	06	0C	7F	0A	00 - 06(0 - 180deg)	05 (150deg)
	Mic. Distance	06	0D	7F	0B	00 - 08(0.3 - 2.7m)	02 (0.9m)
Horn Character	06	0E	--	--	00 - 02(Flat, Mid, Deep)	01 (Mid)	

System Parameters

Category	System Parameters		
	Parameter	Data Range	Default
MIDI	MIDI In Mode In1	Single, Upper, Lower, Pedal, Channel	Single
	MIDI In Mode In2	Single, Upper, Lower, Pedal, Channel	Channel
	MIDI In Mode XMc	Single, Upper, Lower, Pedal, Channel	Single
	TRx. NRPN	Off / On	On
	Tx. Leslie Param.	XM / 21	XM
	TRx. Prog. Change	Off / On	On
	TRx. Drawbar Regi.	Off / On	On
	Rx. Dump	Off / On	On
	TRx. Channel Upper	1 - 16, Off	1
	TRx. Channel Lower	1 - 16, Off	2
TRx. Channel Pedal	1 - 16, Off	3	
Display	To Shortcut	1, 2s, No	1s
	Time Out	4, 8, 16s, No	No
Expression	Gain	70 - 130%	110%

Specifications

Sound Generator

2 x VASE III as
Digital Tone-wheels

Harmonic Drawbars

Pitches

9 Pitches (Upper and Lower)
2 Pitches (Pedal)

Waveform

B-type/Mellow/Brite (Upper
and Lower)
Muted/Normal/Synth1/Synth2
(Pedal)

Percussion

Harmonics

Second, Third

Adjustable

Fast Decay, Soft
Touch, Velocity,
Decay (Fast, Slow)
Level (Soft, Normal)

Tuning

Master

430 - 450 1Hz Steps

Transpose

-6 - 0 - +6 semitones

Effects

Internal Leslie

On, Fast, Brake
Digital, 2 Rotors

Vibrato and Chorus

V1, V2, V3, C1, C2, C3
Upper&Lower On/Off
Speed: 5(6.10 - 7.25Hz)

Overdrive

Digital Overdrive

Equalizer

3 Bands

Reverb

10 Programs

Sustain

5 Lengths (Pedal)

Keymap

Functions

Split
Manual Bass

Adjustable

Split Point
Lower Octave
Pedal Top key

Patches

128 Patches

Display

20-characters, 2 lines
with 12 control switches
and Rotary encoder

Storage

None

MIDI

Templates: 4

Connections

DC Input (15V)
MIDI In1, In2, Out
Exp. Pedal (Phone Jack),
Foot Switch,
Line Out L/Mono, R,
Headphones,
8-pin Leslie

Accessory

AC Adaptor

AD1-1508 (100 - 120V)
AD3-1508 (220 - 240V)

Dimension

396(W) x 172 (D) x 50(H) mm

Weight

1.8 kg

Demonstration Songs and Composers

Playing the demonstration performance:

1. Touch the [MENU/EXIT] Button.
2. Select page 4 by [PAGE] Button.
3. Touch the [ENTER] Button.
4. Select a song by [PAGE] Button.
5. Touch the [ENTER] Button to play.

Songs / Composers

1. **Liberation**
Takanobu Masuda
2. **XM-2 Happy**
Joey DeFrancesco
3. **Acid Wash**
Tony Monaco
4. **Shooting Star**
Daisuke Kawai
5. **B-3 Cookin'**
Deryl Winston
6. **Somthing Slow**
Joey DeFrancesco
7. **Shakin'**
Joey DeFrancesco

Joey DeFrancesco

Joey started playing at the age of four. He recalls, "I could just play. I was already hearing Jimmy Smith and stuff like that around the house. Then one time my Dad, "Papa John" DeFrancesco, brought the Hammond organ home from a gig. When I heard that sound I really got into it. My Dad guided me in the right direction, the do's and the don'ts, but he was never very forceful about it." At the age of 10, Joey was already playing for money on weekend gigs. By high school, he was working steadily around Philadelphia, receiving first-hand instruction from the top-shelf organists who come through the city such as Jimmy Smith, Jack McDuff, and numerous others. His high visibility career kicked off when Miles Davis asked Joey to join his late 80s band. Joey then signed a contract with Columbia that resulted in five records from 1989 to 1994. With the release of his album, "All of Me" in 1989, Joey emerged on the jazz scene. The global jazz community has credited Joey and his recordings, from the late 1980s and early 1990s, as the singular sensation for rekindling a love for the Hammond B-3 organ. In 2003, Joey and his band released their latest hit CD, "Falling in Love Again". This CD featured the Hammond "New" B-3 organ. For the year 2002/2003, the maga-

zine Downbeat chose Joey as "the Jazz Organist of the Year". Currently Joey is very active at Hammond Suzuki. Besides participating at dealer promotions, national conventions, concerts, and clinics, he contributes to Hammond product development.

Tony Monaco

Tony started playing the accordion when he was eight years old. When he was twelve, he was given a Jimmy Smith album and instantly knew that Jazz Organ was his calling. Tony began playing in Jazz nightclubs around Columbus Ohio while he was still learning the art of Hammond B3 organ. He was influenced by hometown Organists such as Hank Marr and Don Patterson. Tony's newfound fascination led him to jazz organ legends Jimmy McGriff, Richard "Groove" Holmes, Charles Earland, Jack McDuff, and Dr. Lonnie Smith. Here he found an unlimited source of inspiration; he just couldn't get enough! On Tony's sixteenth birthday, he received a phone call from Jimmy Smith. This was a great honor and really boosted his enthusiasm as an organist. When he was twenty, Jimmy Smith invited Tony to come play with him at his club in Woodland Hills LA., California. An experience Tony would never forget. In April 2000, Tony met jazz Organist Joey DeFrancesco while Joey was playing in Columbus, Ohio. The two of them became instant friends. Joey recognized Tony's talents right away and offered to produce a CD for him. Tony's recording "Burnin' Grooves" sparked international attention. Tony now travels and plays the "New B3" organ as his relationship with Hammond Suzuki has grown.

Daisuke Kawai

Started music career as a studio musician in 1989. Has supported Cornelius, Shinji Takeda and, recently, the Morning Musume, Ayumi Hamasaki, and coba, etc. Actively performing with his own band "Tone Wheels", and the new unit "Opus".

Deryl Winston

Deryl Winston is a long time resident of San Diego. He began playing the Hammond Organ at age 14 while still living in his native home of Seattle Washington. Deryl was tutored by two of the finest Gospel musicians in the form of his mother Alice Winston (a concert pianist) and Aunt Jean McGraw (Hammond Organist). It was not long before many in the Seattle area became familiar with Deryl and the amazing talent and skill he showed on the Hammond Organ. By early 2000, Deryl was introduced to the Executives at Hammond Suzuki USA. They were very impressed with Deryl and invited him to the Annual Namm Convention in Anaheim Ca. to become one of their artist's. Deryl still continues to travel in the capacity as a Hammond Concert Artist. He provides dedication concerts and conducts seminars on Hammond Organ and it's importance in Gospel music. He's very thankful and proud to represent such a fine company as Hammond Suzuki USA. Deryl's motto is "You ain't Jammin, unless there's a Hammond"!

Takanobu Masuda

Started playing the organ when small. Has been interested in the Hammond Organ since about 15. Purchased the new X-5 and Leslie #760 at the age of 18, then studied mainly Rock style performance and approach.

Later, as a session keyboardist, joined the recordings and lives of various artists. Now gives advice to the makers (Hammond Suzuki) about the XB/XM series from the viewpoint of a professional musician.

- ◆ All the copyrights of these demo-songs belong to Suzuki Musical Inst. Mfg. Co., Ltd.
- ◆ Reproducing these demo-songs for use other than listening individually is prohibited by law.
- ◆ While the demo-songs are playing, the controllers do not function, except [VOLUME].

Factory Patches

Patch #	Name	Patch #	Name	Patch #	Name	Patch #	Name
001	Jimmy	041	Theatre C#	081	White Shade	121	User 1
002	Lo & Hi 1	042	Theatre D	082	Percuss Bass	122	User 2
003	Warmth	043	Theatre D#	083	Four Beat	123	User 3
004	Groove	044	Theatre E	084	Funk Bass	124	User 4
005	Funky	045	Theatre F	085	Surf Coast	125	User 5
006	Purple	046	Theatre F#	086	Blue Tigers	126	User 6
007	Funky 2	047	Theatre G	087	10th Avenue	127	User 7
008	Full Tibias	048	Theatre G#	088	Popcorn	128	Init. Patch
009	Full Organ	049	Theatre A	089	Doubling		
010	Full Church	050	Full Theatre	090	N. E. S.		
011	Jimmy 1	051	Tibia 8 & 4	091	Soloist		
012	Jimmy 2	052	Tibia 8 & 2	092	Choke Nose		
013	Jimmy 3	053	Tibia & Vox	093	S. F. Forever		
014	Burner	054	Tibia 8, 4 & 2	094	Tea Lounge		
015	Groove	055	Tibia 16 & 8	095	Le Femme		
016	Smooth Bass	056	Tibia 16 & 4	096	Triplet 90		
017	Shirley	057	Tibia 16, 8 & 4	097	Triplet 100		
018	Jimmy MC	058	Tibia 16,8,4&2	098	Triplet 110		
019	Fat Bass	059	Tibia 16,8,4,2,1	099	Triplet 120		
020	All Nine	060	Full Tibia	100	Triplet 130		
021	Gospel 1	061	Gedeckt 8	101	XM-2 Happy 1		
022	Gospel 2	062	Flute 8 & 4	102	XM-2 Happy 2		
023	Gospel 3	063	Principl 8	103	XM-2 Happy 3		
024	Gospel 4	064	Princ Chrs	104	Acid Wash 1		
025	Praise 1	065	Rohr Flute	105	Acid Wash 2		
026	Praise 2	066	Gamba Clst	106	B-3 Cookin'		
027	Praise 3	067	Cornet	107	Shooting 1		
028	Praise 4	068	Sesquialtr	108	Shooting 2		
029	Meditation	069	Chrs & Mxt	109	Liberatio 1		
030	Full Gospel	070	Sforzando	110	Liberatio 2		
031	Purple	071	Lo & Hi 1	111	Stopped Fl.		
032	Perc Holow	072	Lo & Hi 2	112	Dulciana		
033	Some Lovin	073	Lo & Hi 3	113	Fr. Horn		
034	Booker	074	Odd Harm	114	Salicional		
035	Rock 1	075	M3 Low Man	115	Flutes 8 & 4		
036	Rock 2	076	Perc 16 & 4	116	Oboe Horn		
037	Rock 3	077	Solo 16 & 2	117	Diapason		
038	Full 1	078	Cute Solo	118	Trumpet		
039	Full 2	079	Eddieswind	119	Full Swell		
040	Full Overd	080	Full Hamm	120	Full Church		

SERVICE

Hammond maintains a policy of continuously improving and upgrading its instruments and therefore reserves the right to change specifications without notice. Although every attempt has been made to insure the accuracy of the descriptive contents of this Manual, total accuracy cannot be guaranteed.

Should the owner require further assistance, inquiries should first be made to your Authorized Hammond Dealer. If you still need further assistance, contact Hammond at the following addresses:

In the United States contact:

HAMMOND SUZUKI USA, Inc.
733 Annoreno Dr.
Addison, IL 60101
UNITED STATES

In Europe contact:

HAMMOND SUZUKI EUROPE
B.V.
IR. D.S. Tuynmanweg 4A
4131 PN Vianen
THE NETHERLANDS

All other countries contact:

HAMMOND SUZUKI Ltd.
25-11, Ryoke 2 Chome
Hamamatsu 430-0852
(Shizuoka)
JAPAN

Website:
www.hammondorganco.com

E-mail: Info@hammondsuzuki.com
Website: www.hammondsuzuki.com

Website: www.suzuki-music.co.jp

Technical materials are available and can be obtained by mailing a request to the appropriate address listed above marked ATTENTION: SERVICE DEPARTMENT.

Manufacturer:
SUZUKI MUSICAL INSTRUMENT MFG. CO., Ltd.
25-12, Ryoke 2 Chome
Hamamatsu 430-0852 (Shizuoka)
JAPAN

