

Emulator Four Keyboard Sampling Synthesis Controller

Operation Manual

© 1995 E-mu Systems, Inc.

All Rights Reserved

• F1498 Rev. B

IMPORTANT NOTICE:

IN ORDER TO OBTAIN WARRANTY SERVICE ON YOUR E4K UNIT, THE SERIAL NUMBER STICKER MUST BE INTACT AND YOU MUST HAVE A SALES RECEIPT OR OTHER PROOF OF PURCHASE. IF THERE IS NO SERIAL NUMBER STICKER ON THE E4K, PLEASE CONTACT E-MU SYSTEMS AT ONCE.

THIS PRODUCT IS COVERED UNDER ONE OR MORE OF THE FOLLOWING U.S. PATENTS: 4,404,529; 4,506,579; 4,699,038; 4,987,600; 5,013,105; 5,072,645; 5,111,727; 5,144,676; 5,170,367; 5,248,845; 5,303,309; 5,317,104; 5,342,990; 5,430,244 AND FOREIGN PATENTS AND/OR PENDING PATENTS. EMULATOR IS A REGISTERED TRADEMARK OF E-MU SYSTEMS, INC.

E-MU WORLD HEADQUARTERS E-MU SYSTEMS, INC. U.S.A.

P.O. BOX 660015
SCOTTS VALLEY, CA USA
95067-0015

TELEPHONE: 408-438-1921
FAX: 408-438-8612

EUROPE, AFRICA, MIDDLE EAST E-MU SYSTEMS, LTD.

SUITE 6, ADAM FERGUSON HOUSE
ESKMILLS INDUSTRIAL PARK
MUSSELBURGH, EAST LOTHIAN
SCOTLAND, EH21 7PQ

TELEPHONE: +44 (0) 131-653-6556
FAX: +44 (0) 131-665-0473

WARNING: READ THIS FIRST

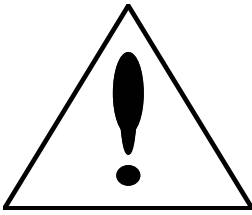

This symbol is intended to alert the user to the presence of important operating and maintenance (servicing) instructions in the literature accompanying the appliance.

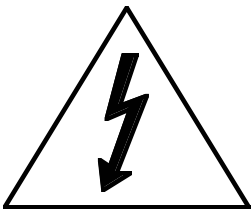

This symbol is intended to alert the user to the presence of un-insulated dangerous voltage within the product's enclosure that may be of sufficient magnitude to constitute a risk of electric shock to persons.

IMPORTANT SAFETY INSTRUCTIONS

Use in countries other than the U.S.A. may require the use of a different line cord or attachment plug, or both. To reduce the risk of fire or electric shock, refer servicing to qualified service personnel. To reduce risk of fire or electric shock do not expose this product to rain or moisture.

GROUNDING INSTRUCTIONS

This product must be grounded. If it should malfunction or break down, grounding provides a path of least resistance for electric current, reducing the risk of electric shock. This product is equipped with a cord having an equipment-grounding conductor and a grounding plug. The plug must be plugged into an appropriate outlet properly installed and grounded in accordance with all local codes and ordinances.

DANGER

Improper connection of equipment grounding conductor can result in the risk of electric shock. Check with a qualified electrician or service personnel if you are in doubt as to whether the product is properly grounded. Do not modify the plug provided with this product. If it will not fit the outlet, have a proper outlet installed by a qualified technician.

CAUTION

If the 6900, E4K is rack mounted, a standard 19 inch open frame rack must be used.

USER-MAINTENANCE INSTRUCTIONS

1. The E4K should be kept clean and dust free. Periodically wipe the unit with a clean, lint free cloth. Do not use solvents or cleaners.
2. There are no user lubrication or adjustment requirements.
3. Refer all other servicing to qualified service personnel.

INSTRUCTIONS PERTAINING TO A RISK OF FIRE, ELECTRIC SHOCK, OR INJURY TO PERSONS

WARNING; When using electric products, basic precautions should always be followed, including the following:

1. Read all instructions before using the E4K.
2. To reduce the risk of injury, close supervision is necessary when the E4K is used near children.
3. Do not use the E4K near water — for example near a bathtub, washbowl, kitchen sink, in a wet basement, on a wet bar, or near or in a swimming pool.

4. The E4K should be situated so that its location or position does not interfere with its proper ventilation.
5. The E4K should be located away from heat sources such as radiators, heat registers, fireplaces, stoves, or ovens.
6. The E4K should only be connected to a power supply of the type described in the operating instructions and as marked on the product.
7. Care should be taken so that objects do not fall and liquids are not spilled into the enclosure of the E4K through openings.
8. This E4K may be equipped with a polarized line plug (one blade wider than the other). This is a safety feature. If you are unable to insert this plug into the outlet, do not defeat the safety purpose of the plug. Contact an electrician to replace your obsolete outlet.
9. The power supply cord of the E4K should be unplugged from the outlet when left unused for a long period of time.
10. This product, in combination with an amplifier and headphones and speakers, may be capable of producing sound levels that could cause permanent hearing loss. Do not operate for a long period of time at a high volume level or at a level that is uncomfortable. If you experience any hearing loss or ringing in the ears, consult an audiologist.
11. The product should be serviced by qualified service personnel when:
 - A. The power supply cord has been damaged; or
 - B. Objects have fallen, or liquid has been spilled into the product; or
 - C. The product has been exposed to rain; or
 - D. The product has been dropped or the enclosure damaged; or
 - E. The E4K does not operate normally or exhibits a marked change in performance.
12. All servicing should be referred to qualified service personnel.

SAVE THESE INSTRUCTIONS

RADIO and TELEVISION INTERFERENCE

The equipment described in this manual generates and uses radio-frequency energy. If it is not installed and used properly--that is, in strict accordance with our instructions - it may cause interference with radio and television reception.

This equipment has been tested and complies with the limits for a Class B computing device in accordance with the specifications in Subpart J of Part 15 of the FCC rules. These rules are designed to provide reasonable protection against such interference in a residential installation. However, there is no guarantee that the interference will not occur in a particular installation, especially if a "rabbit ear" TV antenna is used.

If the E4K does cause interference to radio or television reception, you can try to correct the interference by using one or more of the following measures:

- Turn the television or radio antenna until the interference stops.
- Move the E4K to one side or the other of the television or radio.
- Move the E4K farther away from the television or radio.
- Plug the E4K into an outlet on a different circuit than the television or radio.
- Consider installing a rooftop antenna with a coaxial lead-in between the antenna and television set.

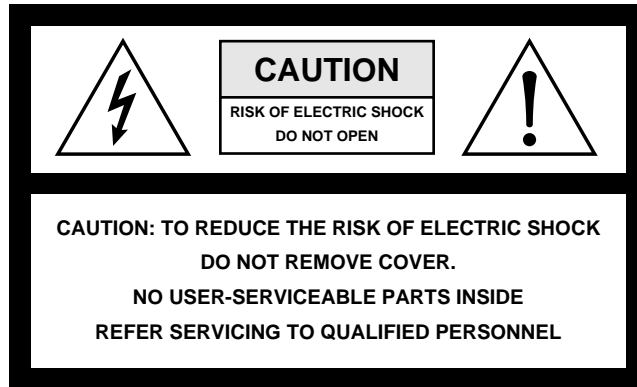

Contents

1 General Instructions

Introduction	3
Main Controls	7
Connections	13
Connecting to an Unformatted Hard Disk	18
Connecting to a Formatted SCSI Device	19
Sampling Basics	21
Definitions	22
Instant Gratification	34

2 Disk Menu

Disk Browser	41
Disk Utilities	45
Mount Drives	46
Copy System	46
Format Disk	47
Install File System	48
Backup	48
Load Bank	50
Save Bank	51
View	52
Info...	52
Folder	53
Bank	57
Preset	62
SoundSprint	62
Sample	68
Sequence	71

3	Master	
	Memory Statistics	77
	Utilities Menu	78
	Assignable Keys	78
	Channel Volume	79
	Tones	80
	Volume Recalibration	80
	Test Access	82
	About the E4K/Credits	82
	Bank Menu	83
	Erase Bank	83
	Name Bank	84
	Auto Load Bank	84
	Setup Menu	85
	Tuning	86
	Tuning Offset	86
	Transpose	87
	Audition Key	87
	Output	88
	Headroom	88
	Output Boost	90
	Output Format	91
	Output Clock Rate	92
	AES Boost	92
	Miscellaneous Menu	93
	Contrast	93
	E4K SCSI ID	94
	SCSI Termination On/Off	94
	Mac on SCSI Bus	95
	Zero Crossing Threshold	95
	Undo/Redo Enable	97
	Wrap Field Selection	98
	Disk Button Goes To:	99
	Import Options	100
	Memory Configuration	102

FX Menu	103
Master Effects A	103
Master Effects B	106
Sequence Manage	107
MIDI Globals	109
MIDI Mode	110
Basic Channel	110
Mode Select	111
Local Control	112
Effects Control Channel	113
MIDI Mix	115
MIDI Controllers	117
MIDI Preferences	119
Velocity Curve	119
Controller #7 Sensitivity	120
Controller #7 Curve	120
Global Pedal Override	121
Receive Program Change On/Off	121
Send Program Change On/Off	122
Magic Preset	122

4 Effects & Sequencer

Dual Effects Processors	127
The Effects Sends	128
Effects B Into Effect A	130
Three-way effects Control	131
Effects as Part of the Preset	132
Master Effects Programming	133
The Effects Channel in Multimode	135
Effect Descriptions	136
Sequencer Manager	141
Utilities	143
Copy	143
Info	144
Setup	145
Time	146

Memory	147
Name	148
Transport	148
To Record a Multitimbral Sequence	151
Recording MIDI SysEx	153
Erase	153
Export	154
Jukebox	156

5 Sample Manage

Overview	159
Utilities	160
Erase Sample	160
Copy Sample	161
Sample Dump	161
Defragment Memory	163
Name Sample	164
Create Sample	165
Left/Right Channels	165
Source & Rate	166
ADC Gain	167
Threshold	168
Sample Length	168
Arm Sample	169
Force Sample	169
Monitor On/Off	169
Keyboard Sample Trigger	170
Automatic Parameters	171
Place Sample	175
Export Sample	175
Get Info	176

6	Sample Edit	
	Background	181
	Utilities	190
	Cut Section	191
	Copy Section	193
	Paste Section	194
	DC Filter	198
	Sample Calculator	199
	Sample Integrity	200
	Loop Type	201
	Tools 1	203
	Loop	203
	Truncation	206
	Taper	207
	Gain Change	209
	Stereo <-> Mono	211
	Swap Left <-> Right	211
	Tools 2	212
	Sample Rate Convert	212
	Digital Tuning	214
	Compressor	215
	Parametric EQ	220
	Reverse Section	222
	Tools 3	223
	Time Compression	224
	Pitch Change	225
	Transform Multiplication	226
	Doppler	227
	Exciter	230
	Undo	231

7	Preset Manage	
	Name Preset	236
	Erase Preset	237
	Copy Preset	238
	New Preset	239
	Export Preset	240
	Get Info...	241
8	Preset Edit	
	Background	244
	Programming Basics	244
	Modulation	245
	Modulation Processors	252
	Dynamic Filter	258
	Selecting Voices, Samples & Groups	264
	Groups	266
	Preset Editor	267
	Preset Edit - Global	270
	Preset Effects A	271
	Preset Effects B	276
	Preset Edit - Links	280
	Utilities	281
	New Link	281
	Copy Link	282
	Delete Link	282
	Subsume Link	283
	Links - Key Window	284
	Links - Velocity Window	286
	Preset Edit - Voices	288
	Utilities	289
	New Voice	289
	Copy Voice	289
	Delete Voice	290
	Split Voice	290
	Solo Voice	292

Sample Zone	293
New Sample Zone	293
Get Multisample	293
Delete Sample Zone	294
Combine	295
Expand	296
Voices - Key Window	297
Keyboard Ranges	298
Voices - Velocity Window	302
Velocity Range	303
Voices - Realtime Window	305
Preset Edit - Dynamic Processing	308
Utilities	311
Voice Select	312
Copy Voices	315
Delete Voices	317
Automatic Voice Selection	318
Set	318
Voice Tuning, Modifiers & Setup	319
Key Transpose	319
Coarse Tuning	320
Fine Tuning	321
Non-Transpose Mode	321
Chorus	322
Delay	323
Start Offset	323
Glide Rate & Curve	324
Solo Modes	325
Latch Mode	326
Assign Group	327
Amplifier/Filter	328
Amplifier Parameters	328
Amplifier Envelope	329
Filter Parameters	330
Filter Envelope	335

LFO/Auxiliary Envelope	336
LFO Parameters	336
Lag Processors	337
Auxiliary Envelope	338
Cords	339
Sample Retrigger	341

9 Appendix

SCSI	345
SCSI Problems	348
SMDI Transfers	349
Multiple Samplers on SCSI	350
E4K Menu Maps	351
Memory Expansion	354
Specifications	361
Warranty	362
Index	364

General Instructions

Introduction	3
Main Controls	7
Connections	13
Connecting an Unformatted Hard Disk	18
Connecting a Formatted SCSI Device	19
Sampling Basics	21
Definitions	22
Instant Gratification	34

Introduction

Congratulations on your purchase of the Emulator Four Keyboard! The various functions of the E4K are organized in this manual by their module. Screen displays and step-by-step instructions are described for all aspects of use and operation. **Sidebar**s are used to highlight important points or to give useful operational tips which might not be readily apparent.

If you are totally unfamiliar with samplers and synthesizers in general, you may need more information than this manual provides. We suggest that you read some of the many books and magazines on the subject of music synthesis. This will help you to get the most out of this extremely powerful instrument.

Important Upgrade information

The E4K is a software-based device. The features and functions of the E4K will be periodically enhanced and upgraded and the new software will be mailed to you on floppy disk. Please take a moment now to read the E-mu Systems warranty and to fill out and send in your warranty registration card. We NEED your mailing address in order to send you upgrades and manual revisions.

The Emulator IV Keyboard

The E4K was designed to be the ultimate in professional sampling keyboards. The features of the E4K expand the state-of-the-art in performance instrument design, from ease of use to the impeccable audio specifications. For starters, the E4K contains an incredible 64 channels of polyphony (32 stereo) and is expandable to 128 channels. The basic E4K comes with 4 Megabytes of sample memory, but this is also user-expandable up to 128 megabytes with standard SIMM modules. With fully expanded memory, the E4K provides over 24 minutes of sampling time!

 **Tips** contain handy tips and tricks which might not be readily apparent.

 **Cautions** warn you of situations that may cause lost data or audio problems.

 **Notes** supply additional information which might be needed for certain applications.

Performance Features

The 76 note (6 octave) keyboard on the E4K is slightly weighted for a responsive feel and responds to velocity and pressure. Four realtime control sliders are integrated into each of the factory sounds to control the most useful aspects of timbre according to the nature of each preset. The realtime control sliders can be easily reprogrammed to control any parameter on the E4K.

In addition to the standard pitch and mod wheels, a new "Thumb button" puts a control switch at your thumb tip. The Thumb button is quite handy to control such things as rotating speaker speed, timbre or any other programmable function on the E4K.

Sequencer and Data Filer

The onboard sequencer is capable of reading and playing back standard MIDI files (format 0 & 1) direct from a DOS floppy disk and saving them to the internal hard disk drive. Music sequences can be stored within E4K banks or as separate objects.

Sound Libraries

The E4K has full access to the huge library of sounds available from E-mu and other sources. It is fully compatible with the legendary E-IV, e-64, EIII, EIIIX and ESI-32 libraries, and can transparently read Emax II, Roland S-760 and Akai S1000/S1100 banks as if they were its own.

Sound Storage

The E4K can access up to 1000 samples per bank arranged in up to 1000 presets. The 50-pin SCSI interface provides access to high density media such as hard disks, magneto-optical disks or CD-ROM. The integral 3.5" floppy disk drive provides a convenient means of updating the E4K software which is periodically being enhanced and improved. Most software upgrades will be mailed free to registered owners.

Our exclusive SoundSprint™ function automatically loads presets from the hard disk as you browse through them. You can continue to play while the new preset is loading in the background.

Other professional features include selectable sample rates of 22.05 kHz, 24 kHz, 44.1 kHz, and 48 kHz. D/A converters are 18-bit linear for wide dynamic range with multiple channels. The Sigma-Delta A/D converters are 16-bit linear. Sampling can be performed in either mono or true stereo.

Advanced DSP

The E4K's advanced features make sampling a breeze. Samples can be automatically truncated, normalized and placed on the keyboard as the sample is taken and advanced tools such as Auto Correlation, Loop Compression and Crossfade Looping allow even the most difficult sounds to be easily looped.

Samples can be digitally spliced and mixed with other samples, and dynamically controlled from the keyboard using velocity and positional crossfading and switching functions. Advanced digital processing features such as Sample Rate Conversion, Compression, Parametric Equalization and Digital Tuning allow you to shape raw samples more quickly and with greater precision than computer based systems. Samples can be quickly and easily transferred between the E4K and an external computer via SCSI if so desired.

Additional digital processing functions include: Time Compression and Expansion, which shorten or lengthen the time of samples without changing the pitch; Pitch Change, which changes the the pitch of a sample without altering the time; Transform Multiplication, which can be used to create weird and wonderful new timbres; and Dopplerization, which allows you to move samples forward and backwards in space as well as from side to side.

Built-in Digital Effects

The E4K incorporates a high quality internal effects processor to add reverb and chorus effects while keeping the sound in the digital domain. 71 different effects are currently implemented. There are several controllable parameters for each effect and any realtime control can be assigned to control these parameters in performance. Sounds with effects applied can easily be resampled and then saved as an entirely new sound with ambience and effects included.

Digital Hardware Features

The E4K's digital hardware implements up to 64 Z-plane filters. These digital filters are very "analog-sounding" and currently implement the following types of filters:

- 12, 24, or 36 dB/octave Lowpass filters with resonance
- 2nd & 4th order Highpass filters with resonance
- 2nd & 4th order Bandpass filters with resonance
- Contrary Bandpass filter
- Three types of swept EQ filters
- Three Phasers and one Flanger with resonance
- Six powerful Morphing filters

Modulation sources include three multi-stage envelope generators and two multi-wave LFOs per channel, as well as a full MIDI modulation control over virtually every parameter. The digital patchbay also contains a set of arithmetic modifiers which allow you to create complex synthesis models.

The E4K is 16 part multi-timbral, allowing complex sequencing and sound effects creation, and can be controlled by remote control using an external computer. A MIDI expander card is available which increases the number of MIDI channels from 16 to 32 channels.

- Eight polyphonic audio outputs allow you to mix and process specific sounds.
- Resampling - The E4K can resample its own output in the digital domain for layering and the creation of new and exciting effects.
- IBM compatible ASCII keyboard interface controls all E4K operations including naming and browsing.
- A digital interface (S/PDIF & AES/EBU) is another standard option which facilitates the transfer of stereo digital audio between digital recorders, mixers, etc.

The E4K is based on the latest G-chip and H-chip digital hardware. The G-chip allows smooth sample transposition over a 10-octave range while the H-chips retain the warm, musical character of traditional analog filters.

The E4K is an extremely powerful and reliable eighth generation instrument. We at E-mu Systems sincerely hope it will help you realize and further your musical potential.

Main Controls

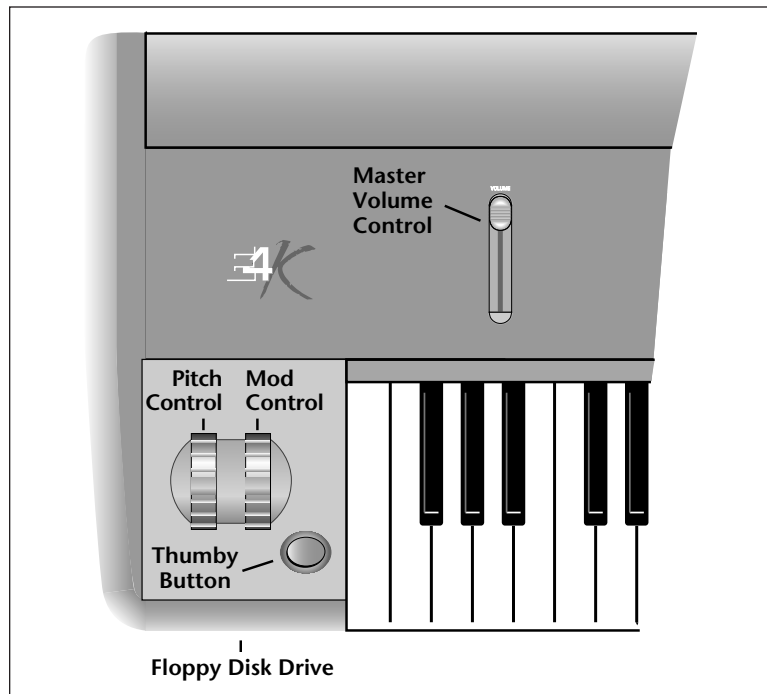

Controller Wheels

The wheels are realtime performance controls and are completely programmable in the preset as to their function. The Pitch Control wheel is a center detent, spring-loaded type and is normally used as a pitch bender. The Mod Control wheel is not spring-loaded.

“Thumby” Button

The Thumby button can be thought of as a footswitch for your hand. Like all the controllers on the E4K, its function is completely programmable. The Thumby button can also be latched by using a the Thumb flip-flop input (Cords menu).

Volume Control

This is the master volume control for all outputs including S/PDIF and the headphone output. The master volume is a digital control. For maximum dynamic range, set this control near or at maximum.

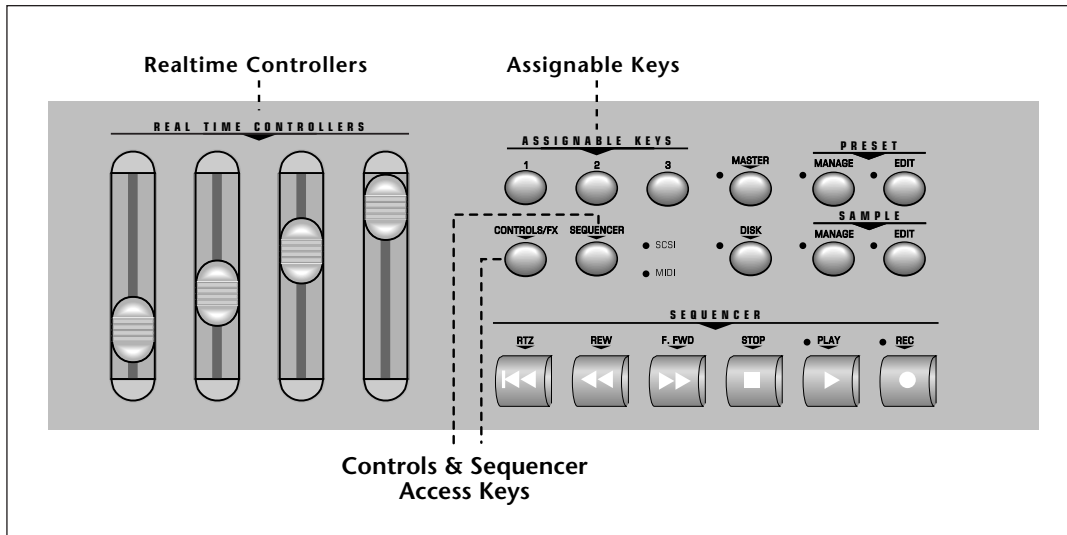

Real Time Faders

These four sliders are powerful performance controls allowing easy access to the most useful aspects of a sound. The function of each fader is completely programmable per preset (Preset Edit, Cords), as is the setting of each fader. The functions of the realtime faders have been integrated into the presets in the E-mu supplied factory banks.

Assignable Keys

These are user-assigned keys which can cause a jump to any screen. **To link an assignable key to the current screen:**

1. Press and hold one of the assignable keys.
2. After two seconds, a pop up window will appear informing you that the assignable key has been programmed for the current screen.

For additional information, see Assignable Keys in chapter three, Master Menu.

Controls/FX Access Key

Pressing this key causes an immediate jump to the Effects and Controls section of the Preset Edit or Master modules.

Sequencer Manage Key

Pressing this key causes an immediate jump to the Sequencer Manage screen of the Master module.

Tip: The Controls key will access the Effects menu (either Master FX or Preset FX) that you used last. Press the Controls key to **Set** the key to the selected menu. Press the Controls key repeatedly to rotate around through the menus.

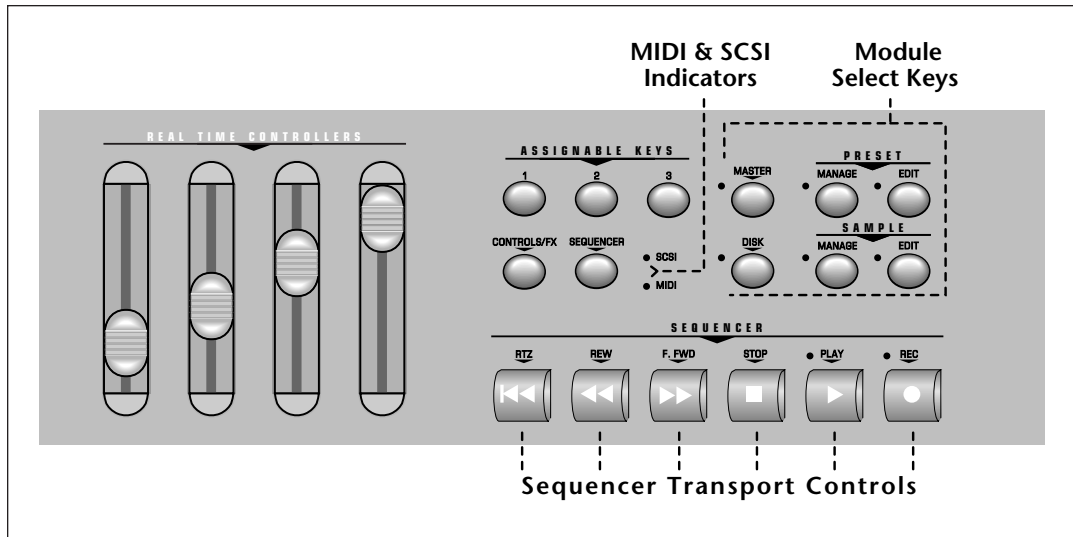

Sequencer Transport Controls

These six buttons control the primary functions of the realtime sequencer. Additional sequencer options are located in the Master module and can be quickly accessed by pressing the Sequencer key.

MIDI & SCSI Indicator LEDs

The LEDs illuminate to show activity on the SCSI bus or incoming MIDI data.

Module Select Keys

The functions of the E4K are grouped according to their function in six modules. The Sample Manage and Sample Edit modules deal with operations at the sample level. The Preset Manage and Preset Edit modules deal with operations at the preset level. The Master module contains functions that affect the entire machine. Any function that has to do with the disk, such as loading, saving and the like is accessed through the Disk module.

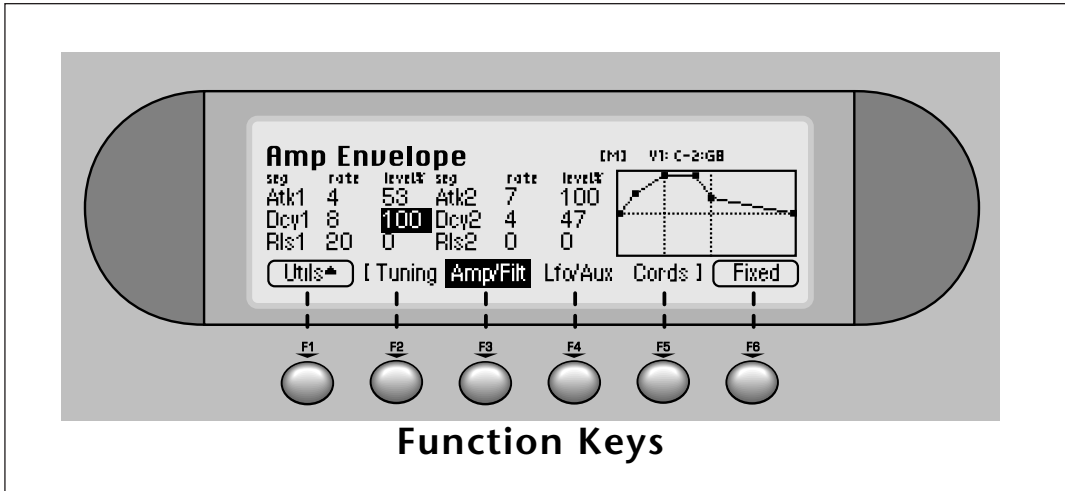

Function Keys

■ **Note:** The liquid crystal display contains a "Screen Saver" which automatically dims the backlight after ten minutes of inactivity.

Any type of activity will reactivate the display to full brightness.

⚡ **Tip:** Holding down the Enter key while turning the data entry control allows "fine tuning" of the value by one number per click.

Function Keys

The lower line of the display will usually contain a row of up to six "soft keys". The soft-keys indicate the function of the keys directly below them.

Cursor Keys

The left, right, up, and down cursor keys are primarily used to move the cursor around in the display. The cursor is a reversed-out section in the display which indicates the currently selected parameter. In the preset selection screen the left and right cursor keys can be used to select the previous or next preset.

Enter Key

The Enter key is used to confirm a particular operation. Enter can be used in place of an affirmative function key response such as "OK" or "Go". In the Disk Browser, pressing the Enter key will advance the selection from: Drives -> Folders -> Banks -> Presets -> Samples. (The Exit key reverses the progression.)

Exit Key

The Exit key allows you to back out of a module one menu at a time, each time the button is pressed. It can also be used anytime you do not want to execute a particular function. In the Sample Manage module, it can also be used to terminate the sampling process.

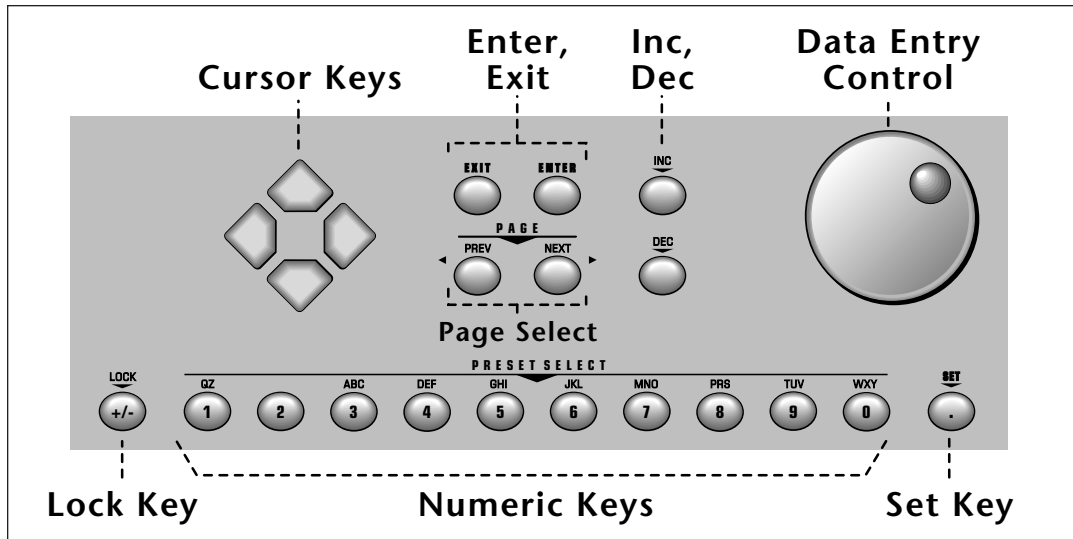

Page Select Keys (Previous & Next)

The previous and next page keys are primarily used to move back and forth between pages when multiple pages of options exist. Each button has an associated LED arrow which illuminates if there is more information on the previous or next page. Arrows in the top corners of the display also indicate if there are more available pages. In the preset selection screen, the page select keys can be used to select the previous or next preset.

Numeric Keys

The numeric keys can be used to quickly select a particular preset or to enter data in precise amounts.

Lock Key - The +/- key has an alternate function as a digit “Lock” key which sets the number of digits that you must enter to change a preset. The status of the lock key is shown in the lower left corner of the display (lock 9.., lock 99.). With one digit locked (100s column), the last two digits of the preset number must be entered to select a preset. (Example: To go from preset 100 to preset 125, you would key in 2 and then 5.) Note that the number of presets available via the numeric keys jumps from 10 to 100.

With two digits locked (10s and 100s column), any one of ten presets can be selected with a single key press. The numeric keys select only the last digit (or ones column) of

the three digit number preset number. For example, if the currently selected preset were 067, pressing the numeric key “3” would instantly select preset 063.

With lock turned off, you select a preset by entering a 1, 2 or 3 digit number. If fewer than three digits are entered, you must press Enter or the Go key after selecting the number.

- The lock key can also be used as a quick way to set the current rank of ten Bookmarks in SoundSprint™ mode. From Sound Sprint mode, press and hold the Lock key, then press a numeric key. This sets the tens column or rank to the number you selected. For example, if you selected Lock-2, selecting 2 on the keypad would select bookmark 22.

Entering Data - The numeric keys can be used anytime the data to be entered is a number, such as selecting samples and presets when you know the exact number. You could simply enter the number without the leading zero as in “10”, In this case, after entering the number, you will be asked to confirm the value by pressing “Go”. The +/- key can be used to indicate if the value is positive or negative. The numeric keys can also be used for naming as some of the keys are labeled “telephone-style” with 3 characters above the key.

Inc/Dec Keys

The increment and decrement keys are used primarily to duplicate the function of the data entry control when a finer degree of control is required. In the preset selection screen the inc/dec keys can be used to select the previous or next preset.

Data Entry Control

The data entry control is a stepped, variable control which is used to change parameter values. The control increments or decrements the current value one unit each click. This control incorporates acceleration (values advance faster if the control is quickly turned).

Set Key

The set key is used to set a “Bookmark” in SoundSprint mode. To set a bookmark, press and hold the Set key while in SoundSprint mode, then press one of the numeric keys. The current preset will be stored under that numeric key and can be selected by pressing the numeric key while in SoundSprint mode. Set also doubles as a decimal point key.

 **Tip:** Up to 100 Bookmarks can be saved to non-volatile EEPROM.

Connections

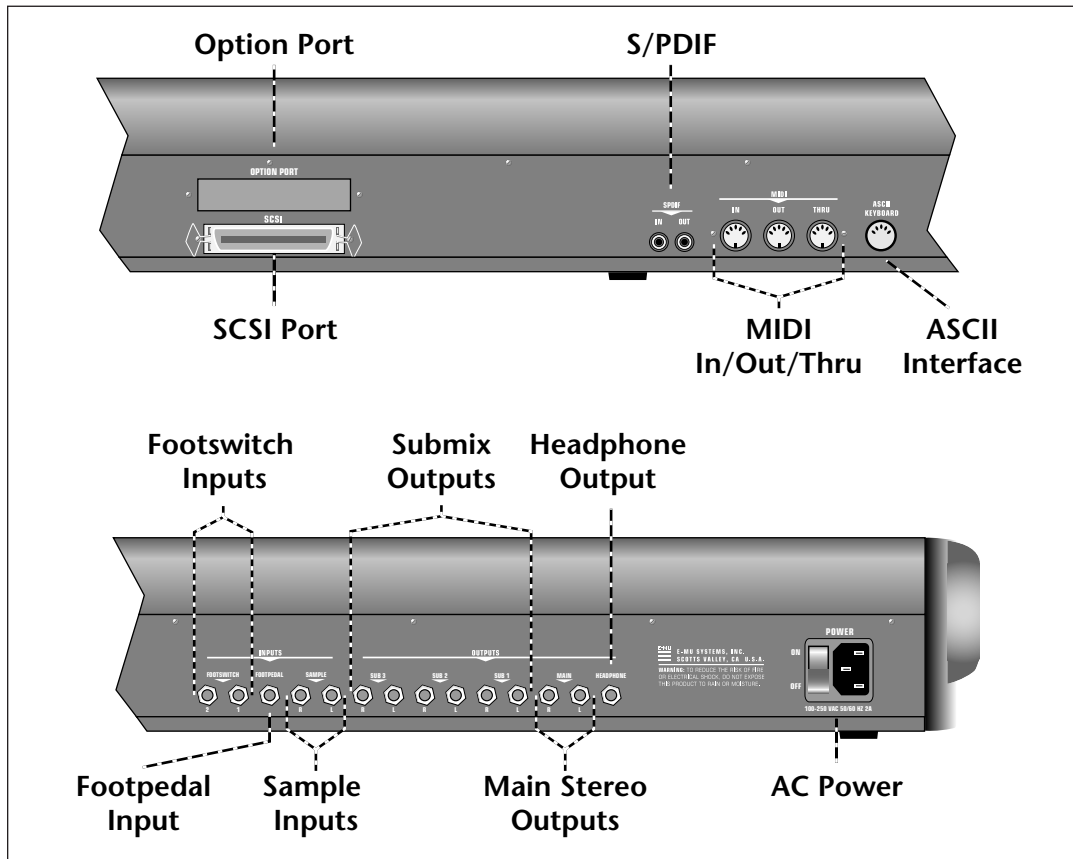

SCSI Port

SCSI is a high-speed parallel interface which is normally used to interface the E4K with external mass storage devices such as hard disks or magneto-optical discs. The dual 50-pin SCSI ports can also be used to link the E4K with an external computer for extremely fast file transfers. The E4K contains advanced SCSI links to facilitate multiple “master” devices on the SCSI bus, such as multiple E4Ks or a computer and an E4K.

For more information on SCSI installation, see page 1-18. Also refer to the manual that accompanies your external SCSI device.

MIDI Connection

The E4K provides a MIDI IN, a MIDI OUT and a MIDI THRU port.

- The **MIDI IN** port connects to the MIDI OUT port of an external MIDI controller which could be a keyboard, a sequencer, MIDI drum kit or whatever. Note that the E4K can only respond to information that your controller transmits. (i.e. If your MIDI keyboard does not have velocity and pressure sensitivity, the E4K will not respond to velocity and pressure.)
- **MIDI OUT** can be connected to another MIDI instrument or computer. The MIDI OUT jack transmits all keyboard controller and preset change information to a sequencer or additional instruments and can also be used to transfer MIDI sample dump information (transfers sample data).
- **MIDI THRU** simply re-transmits any information received at the MIDI IN port.

Option Port

The option port allows you to add additional hardware options such as a MIDI expander card which adds an additional 16 MIDI channels. Other option cards will be announced as they are developed.

S/PDIF Digital Interface

The digital interface allows the E4K to transfer digital audio back and forth with other digital devices equipped with S/PDIF or AES/EBU digital I/O. Keeping the signal in the digital domain is desirable to keep the signal to noise level as high as possible.

The digital input allows you to sample directly from a DAT recorder or other digital device. The digital output reflects the data at the stereo outputs of the E4K. See the Sample Manage module and Output Format (located under Output in the Master menu) for more information.

AC Power Connection

The E4K may be used in environments ranging from 100 volts to 240 volts at either 50 Hz or 60 Hz. No change of voltage settings is required.

The E4K automatically switches itself for the proper line voltage.

ASCII Keyboard Interface

A standard IBM PC style ASCII keyboard can be connected to the rear panel ASCII Keyboard connector. The keyboard must be connected before power is applied in order for the E4K to recognize it. All the front panel controls of the E4K can be accessed via the keyboard. Having an ASCII keyboard is also a real time saver when naming samples, presets, banks and sequences. The keyboard functions are charted below.

E4K	ASCII KEYBOARD
Exit	Esc
Ten Key Pad	Ten Key Pad
Cursor Keys	Cursor Keys, Ten Key Pad
Page Keys	Ten Key Pad 3, 9
Numeric Selection	[Num Lock, Ten Key Pad]
Inc/Dec	+/-
F1-F6	[F1-F6]
Preset Edit	[Alt, A], [Alt, F], [Ctrl, E]
Sample Manage	[Alt, S]
Sample Edit	[Alt, D], [Ctrl, G]
Preset Manage	[Alt, P]
Master	[Alt, M]
Multimode	[Alt, Z]
Disk	[Ctrl, D]
Load Bank	[Ctrl, L], [Alt,]]
Save Bank	[Ctrl, S], [Alt, []
Search Dialog	[Ctrl, F] <i>in Browser</i>
Rename Dialog	[Ctrl, R] <i>in Browser</i>
Audition Preset	[Ctrl, A] <i>Preset related modules</i>
Audition Sample	[Ctrl, A] <i>Sample related modules</i>

Footswitch Inputs

The footswitches can be routed to control any parameter on the E4K through the Preset Edit, Cords menu.

The two control footswitch jacks accept either a normally-open or normally-closed, momentary contact footswitch. The footswitch polarity is automatically sensed on power-up. Additionally, a MIDI footswitch command, on the controller channels programmed in the Master, MIDI menu, will be transmitted from the MIDI Out port whenever a footswitch is pressed.

Footpedal Input

A control footpedal can be used as a realtime performance control in the same manner as the front panel realtime faders or the control wheels. The pedal can be routed to any parameter in the Preset Edit, Cords menu.

Additionally, a MIDI continuous controller message, on the controller channel programmed in the Master, MIDI menu, will be transmitted from the MIDI Out port whenever the footpedal is moved.

▣ **Note:** The footpedal can be either a voltage type (which outputs a DC voltage from 0-9 volts at the tip of the plug) or a resistance type (see the diagram at right).

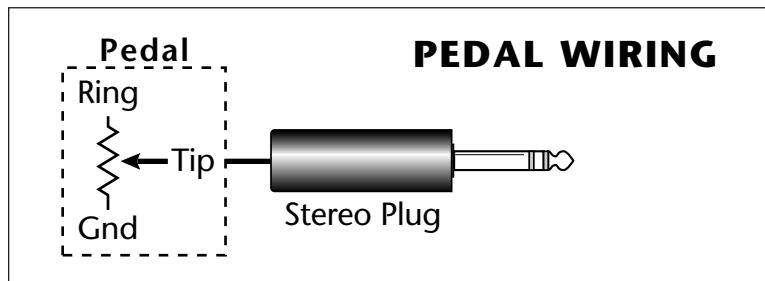

⚡ **Tip:** Use a stereo plug if you want the sample inputs to be balanced (*tip* -, *ring* +).

Sample Inputs

The two electronically balanced sample input jacks accept any level input from microphone to line level. Input impedance is 4KΩ. The gain of the sample input preamplifiers is controlled from the New screen in the Sample Manage module. When in the Sample Manage module the sample inputs can be monitored from the main outputs.

Main Outputs

The E4K has provisions for a variety of output connection schemes. The most common hookup will probably be using the main stereo outputs. The electronically balanced main outputs are available at 1/4" stereo phone jacks. Output level is -2 dBu. Output impedance is 50 ohms.

Submix Outputs

In addition to the main stereo outputs, there are 3 additional pairs of unbalanced submix outputs which can be used when individual processing on specific instruments is desired. Any combination of MIDI channels can be programmed to appear at a submix output pair. Any voice can also be assigned to a submix pair (In the Amplifier screen of the Preset Edit module). MIDI channels can be assigned to the submix pair in the Multimode screen. The submix outputs are all stereo jacks. The tip of each jack (accessed when a standard phone plug is inserted) connects to the left or right output. If a stereo plug is inserted, the **Ring** of the stereo plug serves as a signal **Return** which sums to the main outputs after the effects processors.

Therefore the Submix jacks can serve as effects sends/returns in order to further process selected voices or channels without using the effect sends on your mixer.

The submix outputs are stereo jacks with -2 dBu outputs on the tip of the jack. Impedance is 50 ohms.

Tip: Inserting a phone plug *halfway* into a sub out jack sums it into the main output. This is a handy trick when you need one or two more mixer inputs.

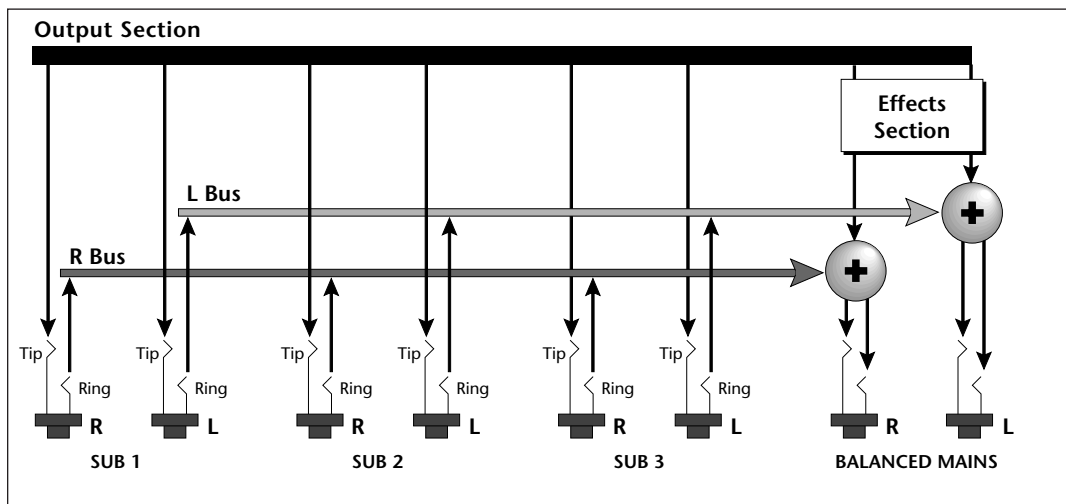

Headphone Output

The headphone output is taken from the main outputs and the volume slider controls also controls the headphone level. This is a high quality headphone amplifier with an output level compatible with professional grade headphones.

 **Tip:** *If the hard disk is already formatted with another file system, you can use the Install File System function instead of formatting the disk. See Disk Utilities.*

► To Connect the E4K to an Unformatted Hard Disk

1. Position the SCSI device and the E4K in a stable location. Hard disk drives are particularly susceptible to shock and vibration. Make sure that you position your hard disk where it won't be bumped or moved while in use.
2. **Important:** Make sure that all power to the E4K and the SCSI device is turned OFF.
3. Connect the SCSI device to your E4K using a quality SCSI cable. Make sure that the connectors are firmly mated and that the wire "keepers" are locked in place. There are two type of SCSI cables in common use: the 50-pin Centronics type and the 25-pin DB connector type. The E4K uses the 50-pin Centronics type connector.
4. Set the SCSI ID of your external SCSI device to any number other than 6. (6 is the default ID of the E4K). Consult the operation manual of your SCSI device for this procedure.
5. Turn on the external SCSI device and the E4K.
6. Make sure your hard disk really is unformatted. Formatting a hard disk erases all the data on it. Press the **Disk** button. If the display does not show the external hard disk icon, the hard disk is may be unformatted. Try mounting the drives (Utilities, in the Disk Browser). Also check that the SCSI ID is not set to 6 (E4K's default).
7. Format the hard disk. While in the Disk Browser, press the soft key **Utils**. A new line of options will appear.
8. Select **Format**. The display will warn that formatting erases everything on the hard disk. Press the **OK** soft key to continue.
9. The E4K will format the hard disk drive. Formatting takes a few minutes. The time will vary depending of the capacity of the disk.
10. After formatting, the hard disk will appear in the disk browser and is now ready to accept data. Use the left/right cursor keys or the data entry control to select the newly formatted hard drive. Use the function key under **Info...** to get information about the new drive.

► To Connect the E4K to a Formatted SCSI Device

The E4K will recognize and load from SCSI devices formatted for E-IV, EIII, EIII, Emax II, ESI-32, Akai S1000/S1100 and Roland S-760.

1. Position the SCSI device and the E4K in a stable location.
2. **Important:** Make sure that all power to the E4K and the SCSI device is turned OFF before you connect or disconnect the SCSI cable.
3. Connect the SCSI device to your E4K using a quality SCSI cable. Make sure that the connectors are firmly mated and that the wire “keepers” are locked in place. The E4K uses a 50-pin Centronics type connector.
4. Set the SCSI ID of your external SCSI device to any number other than 6. (6 is the default ID of the E4K, although this number is user selectable. Master, Misc). Consult the operation manual of your SCSI device for this procedure.
5. Turn on the external SCSI device and the E4K.
6. The SCSI device will appear as a new icon in the disk browser screen.

 **Tip:** Use the “Mount Drives” utility whenever an external SCSI device does not appear in the display.

Sampling Basics

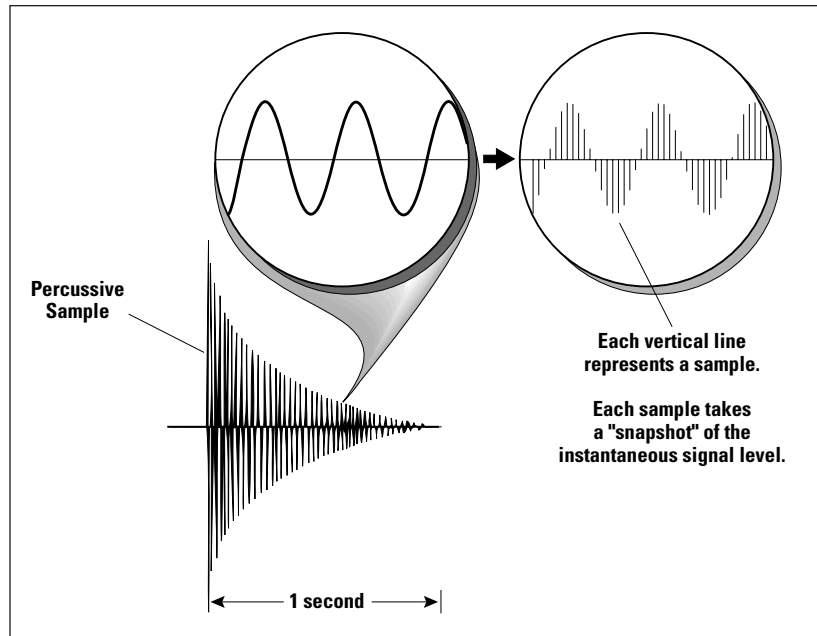

Throughout this manual we will use the terms and concepts described and defined below. Read through this section carefully, even if you don't retain it all. You can refer back periodically as you read through the manual until you understand the basics and definitions.

The E4K is conceptually like a tape recorder. However, the recording process is very different since the E4K digitally records into its computer memory. Sounds for the E4K can be loaded via removable-media hard disk, magneto-optical disk or CD-ROM using the SCSI interface; or they can be sampled through the analog inputs or the S/PDIF digital interface; or even through the MIDI interface using MIDI Sample Dump or SMDI.

Computers can accept information only in the form of numbers, so the E4K accepts audio signals coded into binary numbers. Samplers work by examining (sampling) the incoming signal level at a very high rate (44,100 times a second for compact disc rate), and sequentially recording these different levels in memory. Once stored, these samples may be played back (in the proper sequence, of course) to

reconstruct the original signal. For instance, if a two-second sound were being sampled at 44.1 kHz, it would require 2 x 44,100 or 88,200 samples to be recorded.

A sound can be manipulated once it has been recorded. Playing back the samples in reverse order from which they were stored plays the sound backwards. Playing back the samples at a faster rate than the rate at which they were stored raises the pitch. Playing back at a slower rate lowers the pitch, much like a tape recorder's variable speed control.

Advanced onboard sample editing processors such as Time Compression/Expansion and Doppler allow you to manipulate the sound in both time and audio space. Other processors provide standard studio functions such as parametric equalization, compression and exciter. Far more radical transformations are possible using our exclusive Transform Multiplication process. Sounds can also be manipulated in real-time by filtering or by modulating amplitude and pitch.

Sample Memory & Preset/Sequencer Memory

When you load a sound in the E4K, sound data is transferred from the hard disk into Sample Memory. Presets and sequences are loaded into a special section of memory called "Preset Memory". Preset memory contains all the parameters that make up a preset, such as where the samples are placed on the keyboard, pitch information, loop points, and the other parameters which describe a preset. Preset memory is fixed at 568 kilobytes per bank. Sample memory can be expanded up to a maximum of 128 Mbytes. Because presets use far less memory than do samples, less preset memory is needed.

Tip: The Memory Configuration control (Master, Setup, Memory), allows you to balance the allocation of Preset Memory between the Sequencer and Presets.

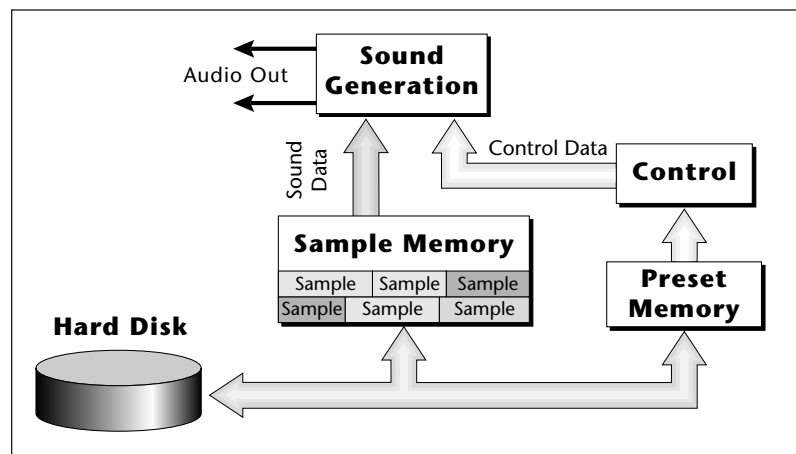

Definitions

How the E4K Organizes Sounds

It is important to understand how the E4K organizes sounds in order to make best use of the instrument in the shortest possible time. Many terms will be introduced now that show up later in the manual.

You can think of the E4K as resembling a collection of sound-organizing modules, all contained within the E4K bank. Pathways indicate how information flows within the E4K. Let's take a closer look at what makes up this information, and how it is transferred from one section of the instrument to another. The **Disk** is the largest element in the E4K hierarchy; the **Sample** is the smallest element.

- **Disk Drive** - Floppy Disk, Hard Disks, CD-ROM Drives, Optical Drives, etc.
- **Folder** - Used to group and organize collections of Banks.
- **Bank** - All samples, voices, and presets - *Everything*, that resides in the E4K's RAM (memory).
- **Preset** - One complete keyboard setup containing one or more voices.
- **Voice** - One complete sound which contains one or more samples with keyboard and velocity settings and all programmable synthesizer parameters.
- **Sample** - An individual digital recording with a name, sample rate and looping information.
- **Sequence** - A sequence of key depressions, controller movements, program changes or system exclusive MIDI data. Ten sequences can be stored with each bank, but sequences can also be exported as Standard MIDI Files or as Emulator sequences.

To explain the hierarchy, we'll begin with individual samples, then work our way through the system.

The Sample

Loading in any sound in mono or stereo creates a sample, the raw material with which the E4K works. The total available sampling time can be divided up any way you like—one long sample, lots of short samples, a few medium samples, or any combination thereof.

The term sample commonly means two different things:

1. A **digital recording of a complete sound**, or
2. **Each snapshot of the sound that makes up the complete sample.** Confusing? You bet! In this manual, we'll assume sample means the complete recorded sound unless indicated otherwise.

You can modify a raw sample in several ways:

- **Transposition:** A sample can be transposed up or down in pitch to cover a particular range of the keyboard. By doing this, it is not necessary to record a sample for every key.
- **Sample Edit:** In the E4K, sample editing might consist of Looping a sample (allowing even short samples to play indefinitely), Truncating (cutting off unneeded parts of a sample, thus saving memory), or any of a number of digital processes that actually change the raw sample data.

Samples can also be named. It is usually a good idea to name your samples with the original pitch as part of the name so that you can place it on the keyboard later at the proper pitch. A bank can hold up to 1000 samples.

Voices

A voice is a complete sound which can be assigned to a range of the keyboard. A sample is the sound-generating portion of a voice. You can think of a voice as a complete instrument consisting of one or more samples, which can then be used as a building block in constructing more complicated presets. A voice consists of one or more samples, a dynamic filter, a dynamic amplifier, three, 6-stage envelope generators, two multi-wave LFOs and 18 modulation routings called “Cords” to connect everything together.

In a typical scenario, you might record several samples of an instrument (such as a piano), then place them into the same voice. Normally these samples would be placed side by side on the keyboard as in the diagram on the following page. You assign the sample to a range by setting the original key, (which is usually the original pitch of the sample) a

■ **Note:** Each Preset can hold up to 256 voices.

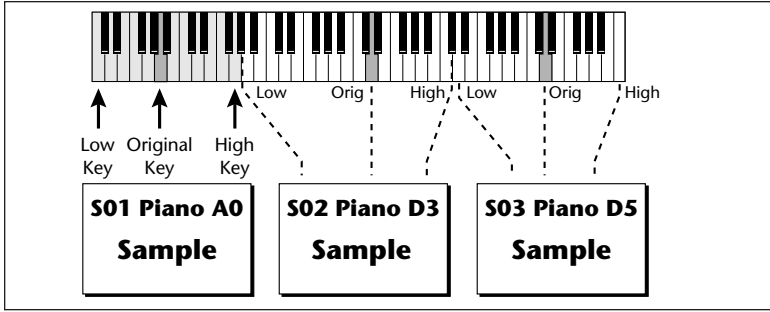

high key and a low key. The number of samples needed for a realistic emulation varies with the instrument, but in general, "More is better".

When a sample is taken, it is automatically placed into a voice with one sample. You can then place the voice (and its sample) on the keyboard.

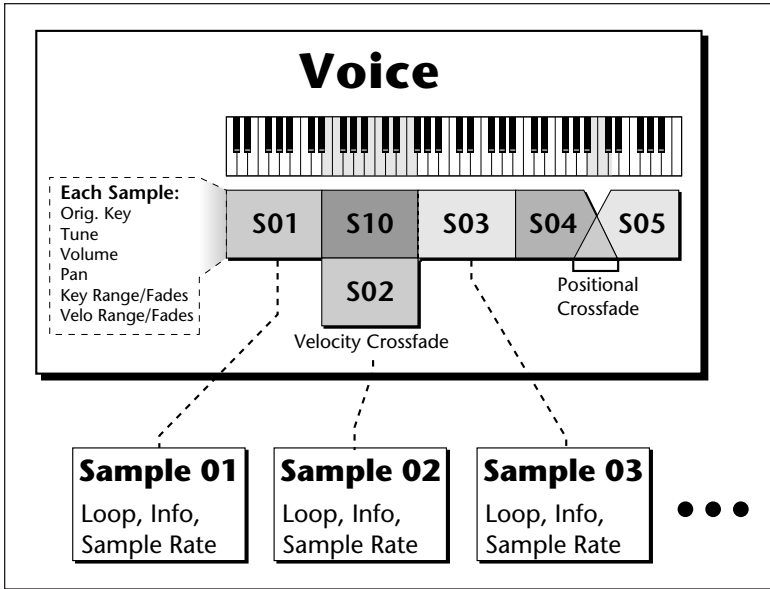

If more than one voice is assigned to the same range, then pressing a key in that range will play all the voices assigned to that range. Voices assigned to the keyboard can be crossfaded by their position on the keyboard or the key velocity. Voices can also be switched or faded depending on the value of a realtime controller such as a modulation wheel, an LFO or an envelope generator.

Preset

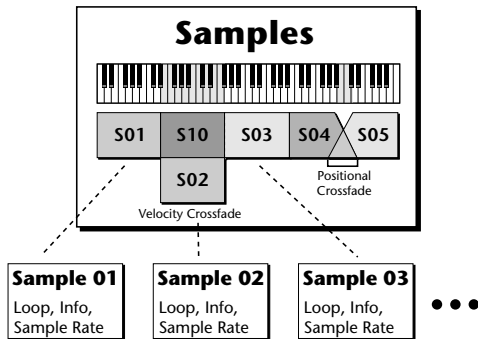
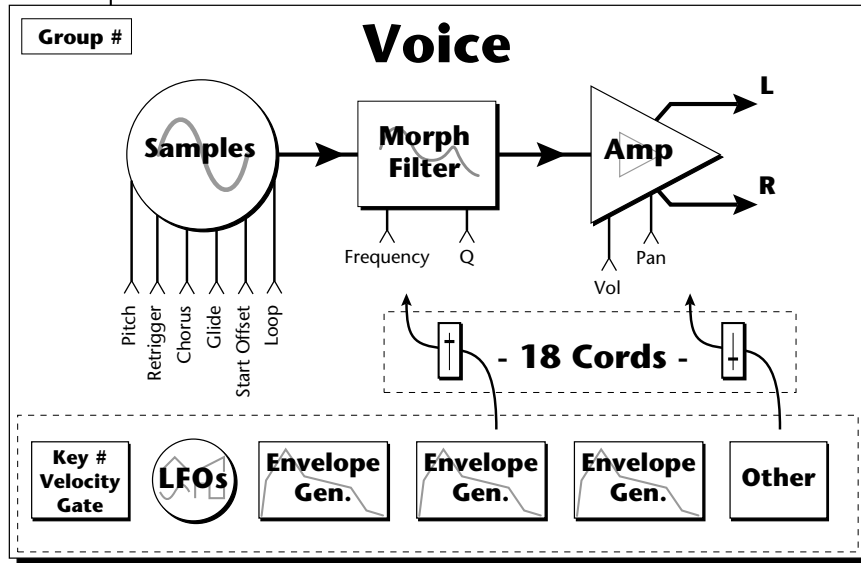
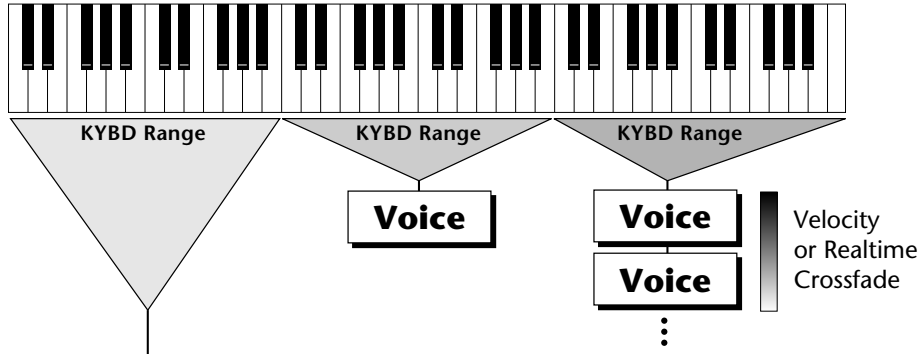

The Preset

A voice can be assigned to a single note on the keyboard, or transposed polyphonically to cover a wider keyboard range. A preset is one entire keyboard setup consisting of one or more voices. The process of assigning, and optionally transposing, samples to specific ranges of the keyboard is called making a preset. Making a preset is a three-step process:

1. Create the preset and give it a number and name.
2. Place voices to different keyboard ranges. For example, with six voices you could assign each voice to cover one octave of a six octave keyboard. A voice can be assigned more than once within a given preset, and assigned to more than one preset. Up to 256 voices can be assigned to a single preset.
3. Choose from a number of available options that further define the preset. Some examples are: assigning samples to partially or fully overlap other samples, thus producing doubling effects, or assigning dynamic control to individual voices in a preset. Overlapping voices can be crossfaded using any modulation source. You can modify voice parameters and set up MIDI and dynamic processing parameters.

The E4K allows you to be very flexible in the way you construct presets. Consider this — you can assign samples to the keyboard inside the voice *or* assign single sample voices to the keyboard. Unless you specify otherwise, only one sample is assigned per voice. In this case you would assign voices (and the single samples they contains) to the keyboard and create presets. On the other hand, you may wish to create finished voices *before* you start designing presets and treat the voice as your finished sound. In this case, the preset can be used to crossfade, layer or switch multiple complex voices.

SoundSprint™

SoundSprint is a special mode on the E4K used to quickly and automatically load presets within a folder as you browse through them. Presets are loaded in the background while the keyboard remains active with the last preset. Loading time varies with the size of the preset, but most presets load in two or three seconds.

Presets loaded via SoundSprint are placed at the top of the bank memory and are assigned preset numbers 990-999. Up to ten Sprint presets can reside in RAM and can be instantly selected. Presets loaded using SoundSprint remain in the E4K's RAM until ten Sprints have been loaded, at which time the oldest Sprint preset is erased. SoundSprint will not overwrite a preset that has been loaded in the conventional manner and the E4K will display a "Memory Full" message. *See also:* SoundSprint in chapter 2 - Disk Menu.

Bookmarks

When in SoundSprint mode, you can attach Bookmarks to your favorite presets so that they can be instantly selected with a single or double key press. Up to 100 bookmarks can be stored and saved to non-volatile EEPROM. For additional information on bookmarks, see Bookmarks in chapter 2, Disk Menu.

The Bank

The bank contains samples, voices, presets and sequences. **Everything** that is loaded into the E4K is part of the bank. Although the memory is volatile, meaning that the data disappears when you turn off power, all bank data can be saved permanently to the hard disk drive or other media to keep a record of your work. A bank can hold up to 1000 presets (000-999).

Folders

A folder can contain up to 100 banks (0-99). You can use folders to organize your sound banks or you might want to include all the banks used for a particular project in a folder. The number of folders in a disk depends on the size of the disk. As an example, a one gigabyte hard disk can hold 96 folders.

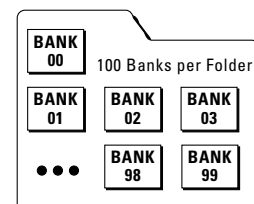

The Internal Drive

A disk drive is a memory storage device that stores banks of data. The E4K has an internal hard disk drive which is used to load and store bank data. The floppy drive on the E4K is used mainly to update the operating system software. (The operating system of a computer consists of the instructions that tell the computer what to do.) It is also ideal for transferring sequences to and from a computer-based sequencer. Because of the large bank size of the E4K

(4-128 MB) the floppy disk is impractical for backing up sound data, although it can be used to save or transfer small sound banks in a pinch. Other types of disk drives, as described below, can connect to the E4K to provide efficient sound storage.

- **Floppy Disk Drive (Drive 0):** The floppy disk drive accommodates 3.5", double-sided, high-density (1.4 MB) floppy disks. The floppy drive is used mainly as a convenient way to update the operating system software. As new enhancements are developed, the new software is distributed on floppy disks. This software can be copied into Flash RAM and made a permanent part of the E4K.

► **To Update the Software of the E4K**

- 1) Turn off power to the E4K
- 2) Insert the floppy disk into the drive with the label side towards the center of the unit.
- 3) Turn on power.
- 4) Press Enter to update or Exit to cancel.
- 5) Wait for the E4K to update its firmware.

- **Internal Hard Disk Drive (Drive 1):** A hard disk provides the advantages of much higher memory capacity and far faster access time. However, the hard disk cannot be removed and its data must be backed up to another medium for safekeeping.

External Drives

The Emulator IV Keyboard contains a SCSI (Small Computer Systems Interface) connector on the rear panel. This interface is commonly used in the computer industry, so many devices made to work with computers—particularly mass storage devices—will also work with the E4K. Here are some of the types of mass storage devices that can plug into the SCSI connectors.

- **Hard Disk Drive:** A hard disk provides the advantages of much higher memory capacity and far faster access time. Transferring data to and from the E4K is quite straightforward. However, you cannot remove a hard disk and replace it with another one—the disk is a permanent part of the drive. There are three main cautions involved with hard disks:

1. Hard disks are sensitive to extreme mechanical shocks. If your hard disk falls off a keyboard stand, chances are the hard disk will be damaged.
2. Make sure power is not interrupted when you write data to the hard disk.
3. Hard disks have reached a very high level of reliability. However, they can fail from time to time (as can any part of a computer), so any data should be backed up periodically on some other medium.

- **Removable-media Hard Disk Drives:** These are similar to normal hard disk drives except that the disk itself can be removed and replaced with another disk. Disk densities can range from 44 Mbytes to well over 200 Mbytes per platter. Removable-media hard disk drives allow you to build a sound library of unlimited size and are quite handy for transferring sounds between machines. They're also perfect for backups.

- **CD-ROM Drive:** A CD-ROM is a playback-only (data cannot be written to it) mass storage memory device whose capacity is approximately 660 Megabytes. Quality CD-ROM libraries are available from several companies (E-mu Systems, InVision, Northstar, Q-Up Arts). These can be loaded into the bank as easily as you would load from a hard disk.

- **Magneto-Optical Drive:** Basically a read/writable CD, these high speed, high density storage devices are currently the hottest thing around for storing large amounts of sound data. Typically a magneto-optical drive can hold upwards of 300 Mb per side and the removable cartridges can be used over and over. Disk access time is comparable to a normal hard disk.

Advantages: High-speed, high-density, reliable, removable.

Disadvantage: Slower than most hard disks. High cost (although prices are dropping fast).

▣ **Importing:** *When a bank is imported from another sampler, the E4K will organize the samples into voices and multisampled oscillators as logically as possible.*

For example, when importing from the E11X, samples with identical dynamic processing parameters will be placed into the same voice. Primary and secondary layers will be placed in groups 1 and 2.

Modules

A module controls a particular set of functions in the E4K. There are six main modules: Master, Disk, Preset Manage, Preset Edit, Sample Manage and Sample Edit.

- **Activating a Module:** To work with a module, you must first activate it. Press the button associated with the desired module.
- **Function Key Menus:** Menus are selected using the soft keys along the bottom of the display. Pop-up menus may also be used when a field being edited has a small number of choices.
- **Page Selection:** Each module contains several pages which contain controls for additional functions.

In a graphical display, the different fields can be selected in the following ways:

- **By pressing the arrow keys (up, down, left, right)**
- **By turning the data entry control**
- **By assigning an assignable key to jump directly to the screen you want to edit**

Pressing either the module button or the Exit button will cancel any operation.

The **Module** keys are located on the left side of the control panel. Each module affects a specific area of the E4K's operation.

- **Disk:** This module controls everything to do with the disk drives where E4K's sounds are stored. You can browse through the disks, examine their contents and audition sounds directly from a hard disk before loading. If you are looking for a specific sound, the E4K can help you find it with its "Find" function.
- **Master:** This module contains functions that affect the entire machine, such as master tuning, headroom, master FX, output sample rate, LCD contrast, and much more.
- **Sample Manage:** This "recording studio" module records sounds from the outside world into the bank. Features include adjustable preamp gain, variable threshold setting, and adjustable sample rate and length.

- **Sample Edit:** With this powerful module, you can edit a sample's length, loop (i.e. infinitely sustain) any portion of the sample and have the E4K automatically find the best loop points (Auto Correlate). You can splice two different samples together, mix samples, or perform a variety of advanced digital signal processes on the sample.
- **Preset Manage:** This module handles the preset “housekeeping”, allowing you to create new presets, copy them to any location, rename them or erase them.
- **Preset Edit:** This module lets you alter the synthesizer voice parameters of the E4K, such as shaping the amplitude and filter dynamics or adjusting the keyboard dynamic response. Voices can be placed on the keyboard, moved around or shaped in just about any possible way.

Saving

The bank only retains data for as long as the E4K is plugged in and turned on. Of course, we don't expect you to leave the thing on all the time, which brings us to the subject of saving data.

Pressing the **SAVE** function key from the disk module shuttles all the bank data (samples, voices, presets and sequences) to the drive of your choice. A hard disk permanently stores data so that even after turning off the E4K, the disk will contain a record of your work.

IF YOU DO NOT SAVE A BANK, ALL BANK DATA WILL BE LOST WHEN YOU TURN OFF THE E4K.

Do not wait until the end of a session to save. Save your work periodically in case of power failure or some other unforeseen circumstance that might erase the bank's memory. Hard disks are not infallible. All hard disk banks should be backed up periodically to another hard disk or other media. Should you improve the preset or sample later, you can always replace the original with the revised version. And if something goes wrong, the original will still be available to save you the ordeal of starting from scratch.

Whenever you have done enough work that you would hate to lose it, back it up!

Since the disk contains a record of the bank data, loading the disk bank transfers all the sample and preset data into the bank. This will replace the existing bank data, if any.



D0 Floppy

This is the icon for the floppy disk drive.

Default

A default setting is what we've judged to be a useful initial setting, and remains in effect until you change it. For example, if you create a new preset, transpose will default to "0". Had it defaulted to +12, all new presets would be transposed up an octave.

Icons

An icon is a little picture of an object such as a floppy disk, a hard disk, folders, banks, presets or samples. In the disk browser screens, icons are used as an easy way to identify and select the appropriate object. When an icon is selected, the image will reverse (black to white & vice-versa).

The Cursor

The cursor is a highlighted area on the display. It shows you the number or letter that will be altered if you enter data. Entering a new value will overwrite the number or letter above the cursor, whereupon the cursor will move on to the next number or letter (if applicable). If the E4K is expecting a two or three-digit number, in most cases you must enter all the required digits even if some of these are zeroes (called leading zeroes). For example, if the E4K is expecting a three-digit number and you want to enter 8, you would enter 008. If it is expecting a single-digit number, entering 8 would be sufficient.

Data Entry Control & Increment/Decrement Keys

In virtually all instances where the data entry control selects options, the increment (Inc/Yes) and decrement (Dec/No) buttons duplicate the data entry control. Press Inc/Yes to increase a value, or Dec/No to decrease by one value at a time.

Selecting

When the instructions say to select an option, you can use whatever method is most comfortable for you: the data entry control, the increment/decrement keys, the numeric keypad (if applicable) and, when naming, the keyboard keys. Some functions do not implement all these options; you can't go wrong by trying, though. If a function doesn't respond to the numeric keypad, for instance, then pressing the keypad will have no effect. Use the data entry control or the inc/dec keys instead.

The Big Re-Cap

- A sample is a raw sound that is loaded into the bank.
- A voice is a complete E4K sound, consisting of one or more samples, processed through the dynamic signal processors, that is mapped onto the keyboard.
- To create a new preset, make sure you have all the samples required for the preset, then assign combinations of voices from the bank to specific sections of the keyboard.
- After arranging a bank, it can be saved to one or more drives.
- Since loading from a hard disk fills the bank with samples, voices and presets, you can group these voices and samples into new presets, process the samples contained in particular voices, or alter existing presets.
- Presets loaded via SoundSprint are always placed in preset locations 990-999.
- Up to ten sequences can be saved with the bank. Exported or Standard MIDI File sequences appear in the bank browser.

Instant Gratification

This short section is designed to get you playing sounds in the shortest amount of time. It contains only a partial explanation of disk operations. For more complete instructions, see Chapter 2, Disk Module.

► Loading SoundSprints

1. On the front panel, press the **Disk** key (*see Tip*). The following screen will appear.

Tip: The Disk Key can be set to call up either SoundSprint mode or the Last screen you used in the Disk Browser. This preference is located under *Master, Setup, Misc*.

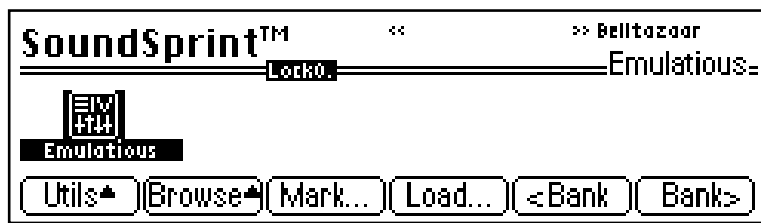

2. Use the bank soft-keys (F5 & F6), the left/right cursor keys, the previous/next keys or the data entry control to select new presets. The previous and next presets in the folder are shown in the upper right of the SoundSprint display window.

► Loading a Bank from the Hard Disk

Loading SoundSprints is just one of the ways to load sounds into the E4K. You can also load an entire bank of sounds so that have a collection of different preset immediately available.

1. Clear the bank memory to make room for a new bank to be loaded. Press **Master**. Press **Bank** (F2). Press **Erase** (F1). Press **OK** (F6) in response to the dialog box message and erase the bank.
2. From the main screen, press the **Arrow** function key (F6) in the lower left corner of the display.



Press

Five additional soft key choices will appear.



3. Press the Load function key (F4). The following screen will appear.

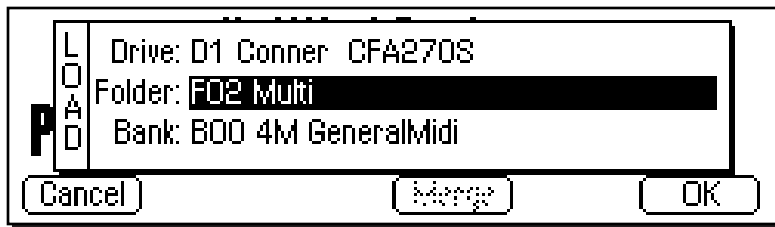

4. Move the cursor to the Folder field and select the Multi folder. Move the cursor back down to the Bank field and choose a bank to load using the data entry control, the inc/dec keys or the numeric keypad. Press OK to load the bank or Cancel to cancel the operation. If you pressed "OK", the bank will be loaded and the first preset of the bank you selected will appear.

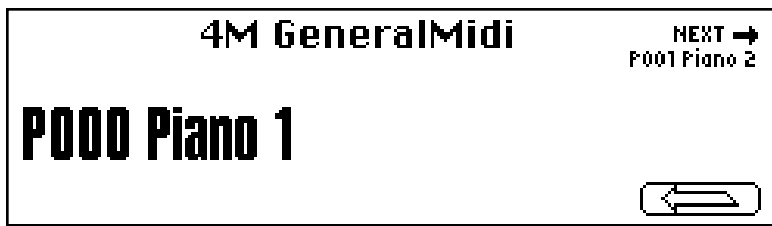

► Selecting Presets

1. The main preset selection screen is shown above. Presets can be selected using the data entry control, the cursor keys, the page keys, the inc/dec keys, the numeric keypad or from your MIDI controller. The previous and next presets are displayed in the upper corners of the display.
2. When using the numeric keypad to select presets, you may enter leading zeros (i.e. type 0, 0 and 2 to select preset 002) or simply type in 2, then press **Go**. If you do not enter the leading zeros a screen will appear to confirm your choice. Press **Go** to confirm your choice or **Cancel** to cancel the operation.

► Selecting Multimode

1. Multimode allows the E4K to respond to multiple MIDI channels at once. Press the arrow key  then the Multi function key (F6) to turn on Multimode and display the Multimode screen as the main screen. The Multimode screen is shown below.

Multimode		volume	pan	submix	pitch	mod	
Ch 1	P002 Sitar	127	+0	voice	0	0	
Ch 2	P014 Tabla Sustain	81	+0	voice	0	0	
Ch 3	P024 Sarod Sleatk	78	+0	voice	0	0	
Ch 4	P081 Srngi(Seq Prst)	106	+14	voice	0	0	
+							
		View		Load...		Save... Omni	

2. Press the **View** function key to select MIDI Mix view. The MIDI Mix screen allows you to display and adjust the preset, volume, pan settings and output assignments for up to 16 MIDI channels. This is a useful feature to fine tune multi-timbral sequences. This screen also allows you to override the output channel programmed in the voice. Any volume pan and preset changes made over MIDI will be reflected in this display. (Volume = MIDI continuous controller channel #7, Pan = MIDI continuous controller channel #10)

■ **Note:** *Pan ADDS to the pan setting made in the voice and is not an absolute pan setting.*

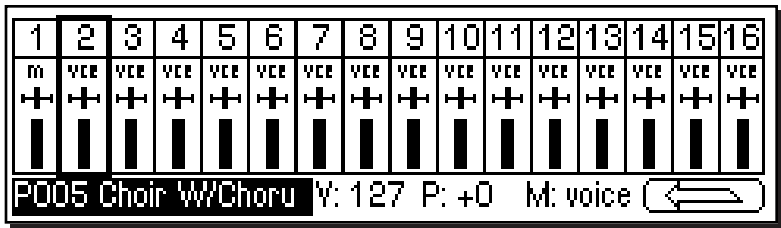

► **To Adjust the MIDI Mix**

1. Select the desired MIDI channel using the up/down cursor keys.
2. Select preset, volume, pan or the output assignment using the left/right cursor keys. Change the parameter values using the data entry control, the inc/dec keys, or the numeric keypad.
3. Press the  key to call up the Load, Save and Omni soft keys. Press **Omni** to return to normal (single preset) mode.

 **Tip:** *Omni mode plays only the currently selected preset from any MIDI channel.*

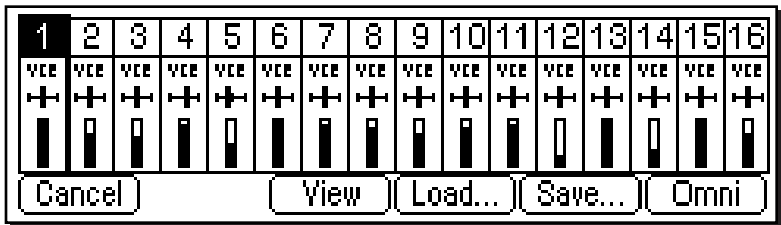

Disk Menu

Disk Browser	41
Disk Utilities	45
<i>Mount Drives</i>	46
<i>Copy System</i>	46
<i>Format Disk</i>	47
<i>Install File System</i>	48
<i>Backup</i>	48
<i>Load Bank</i>	50
<i>Save Bank</i>	51
<i>View</i>	52
<i>Info...</i>	52
Folder	53
Bank	57
Preset	62
<i>SoundSprint</i>	62
Sample	68
Sequence	71

Disk Browser

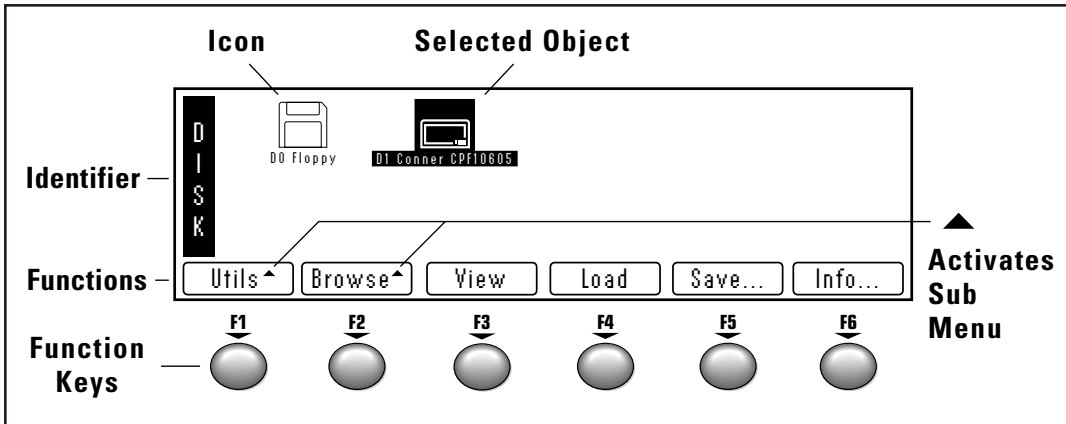

The Disk Browser makes it easy to navigate through the different levels of the disk drives. Take the time to familiarize yourself with this section because the browser is such an integral part of the E4K. A brief recap of the E4K disk hierarchy is as follows:

- **Disk Drive** - Floppy disk, hard disks, CD-ROM drives, optical drives, etc.
- **Folder** - Used to group and organize collections of banks.
- **Bank** - A group of presets which can be loaded into the E4K's memory.
- **Preset** - A complete sound: samples, voices and all programmable options.
- **Sample** - An individual digital recording with looping information.
- **Sequence** - A recording of keyboard key depressions (with velocity and pressure) and any other performance controllers (pitch and mod wheels, real time control sliders, thumb button, footpedal, foot switch and program changes). Sequences can be stored along with the bank or can be exported as separate entities which appear as icons in the bank browser.

Tip: The *Info...* key gives information about the selected object.

The type of *View* (list or icon) you choose is remembered for each level.

► **To Browse the Disk:**

1. Press the **Disk** key. The LED will illuminate and the screen shown below will appear.

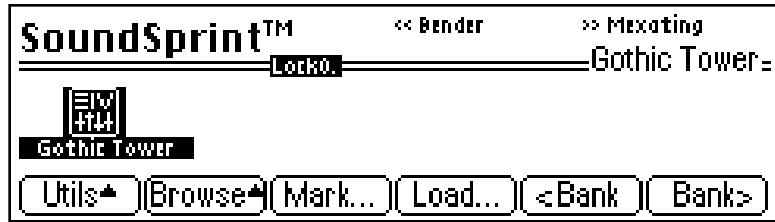

- **SoundSprint™** - The Emulator Four Keyboard contains a special function called "SoundSprint".
2. The selected preset icon will be flashing, indicating that the preset is being automatically loaded. SoundSprint is a powerful function for auditioning presets from the disk or when the bank is too large to be loaded into the available memory of your E4K.
 3. Use the up/down/left/right **Cursor Keys** to select another preset to be loaded. This takes a couple of seconds, but note that the currently loaded preset remains active until the new preset is loaded.

- If another page of choices exists, the right page arrow LED will be illuminated.
- If other banks of presets exist in the folder, the **<Bank** or **Bank>** function keys can be used to select them.

4. To turn SoundSprint Off, press the **Utils** function key (F1), then press the **SprntOff** function key (F5).
5. Choose one of the presets, then press the function key under **Browser** again. Press the function key under **Samples** to examine the samples used in the selected preset.

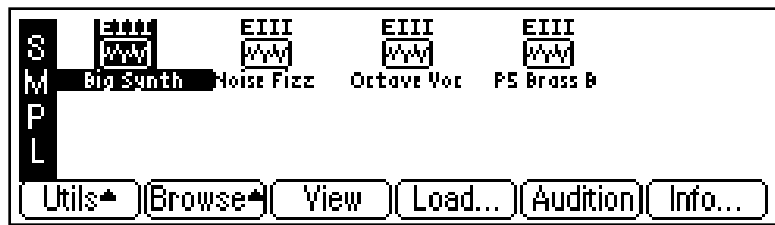

Tip: To turn Sprint mode On from the preset menu, press Sprint (F5).



Tip: The Disk Key can be set to call up either SoundSprint mode or the Last screen you used in the Disk Browser. This preference is located under **Master, Setup, Misc**.

6. Press the **Info...** function key (F6), a pop-up window appears with information about the sample. Press the **OK** function key to return.

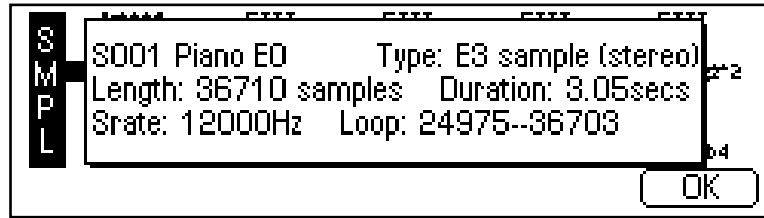

7. Pressing the **Exit** key “backs you out” of the pages. Press the **Exit** key once from the sample browser to return to the bank page. Pressing **Exit** again puts you in the folder page. Press it once more and you're in the disk page. Press **Exit** one more time and you're out of the disk module altogether and back in the preset selection screen.
8. Press the function key under **Browser**. Press the function key under **Seqs** to examine or load the sequences resident in the selected bank. If no sequences exist, a pop-up window will inform you of this fact.

Tip: Use the **Exit** key to back out of the pages.

Tip: The **Enter** key can be used to step forward through the **Folder**, **Bank**, **Preset** and **Sample** browsers.

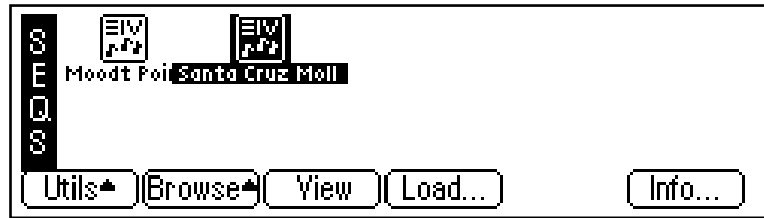

9. The browser lets you examine the various levels of the disk, such as banks, presets and samples. When SoundSprint mode is turned On, the preset page of the Browser will be replaced by SoundSprint and the selected preset will be automatically loaded whenever the Sound Sprint page is active.
10. Select the hard disk drive under **Drives** in the Browser. The selected drive will be reversed out. In the following diagram, the Conner hard disk is selected. When an object is selected, its full name is displayed.

11. Press the **View** function key (F3). The display now changes to a list format. Press the view key again to return to the icon display.
12. Press the **Info...** function key (F6). A pop-up window appears with information about the hard disk drive. Press the OK function key to return.

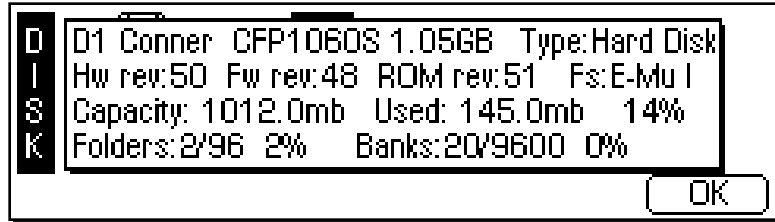

13. Press the **Browser** function key (F2). Another row of function key choices will appear.

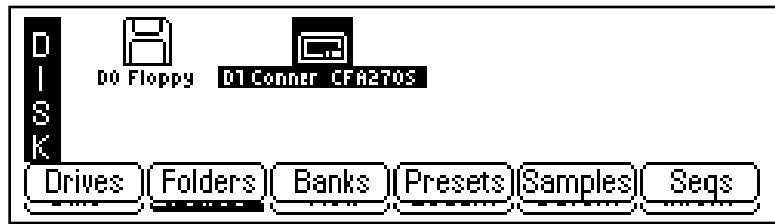

14. Press the function key under **Folders**. The screen shown below will appear.

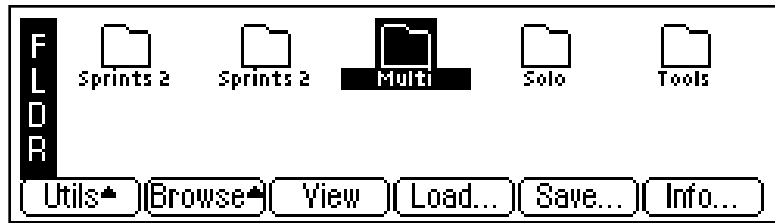

15. The display now shows the various folders of banks and presets resident on the hard disk. Use the cursor keys, inc/dec keys, or the data entry knob to select the active object.
 - If another page of choices exists, the right page arrow LED will be illuminated.

16. Choose one of the folders, then press the function key under **Browser** again. Press the function key under **Banks** to examine the banks in the selected folder.
 - **Note:** Sequences saved as Standard MIDI Files also appear as banks in the bank browser.

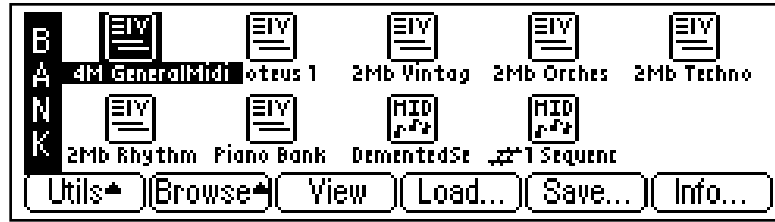

17. Choose one of the banks, then press the function key under **Browser** again. Press the function key under **Presets** and you're back in Sound Sprint mode. If Sound-Sprint mode is turned Off (Utils, SprntOff), the Preset screen shown below will appear instead.

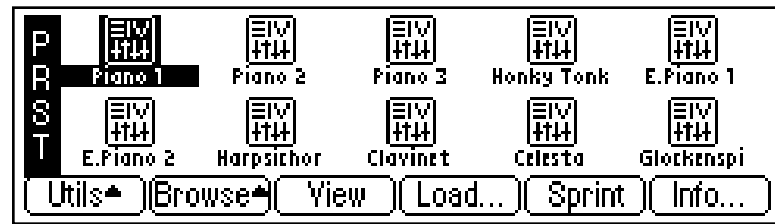

DISK

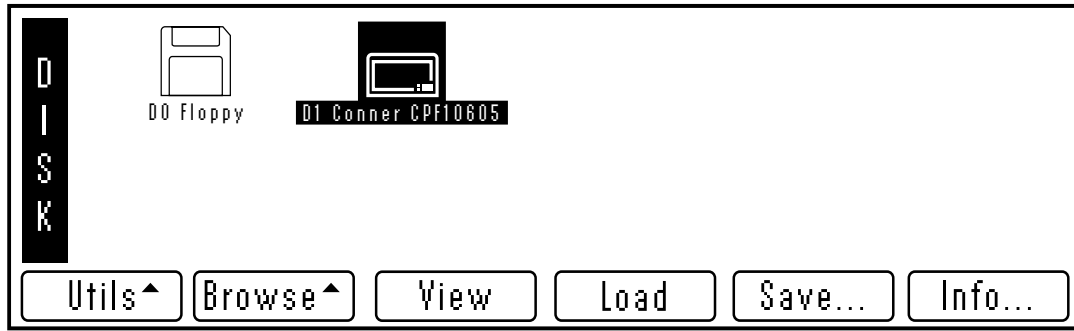

The disk page of the browser contains functions and operations related to storage media such as floppy disks, hard disks, CD-ROM drives, magneto-optical drives or whatever. When in the disk page, all drives which are connected to the SCSI port will appear as icons in the display.

DISK UTILITIES

The Disk Utilities menu contains several additional functions. Pressing the Utils function key (F1) from the disk browser enables a second row of soft keys.

- **Mount Drives:** Instructs the E4K to check the SCSI bus for the presence of SCSI devices.
- **Copy System:** Allows you to update and make copies of the E4K operating system supplied on floppy disk by E-mu Systems or your authorized dealer.
- **Format Disk:** Initializes a floppy disk or a hard disk drive to store E4K data.
- **Install FS:** Allows you to install the E4K file system on pre-formatted hard disks.
- **Backup:** Hard disk drives can and do fail from time to time. This function allows you to backup and restore your valuable data to another hard disk or SCSI media.
- **Find:** This function allows you to find specific samples presets, folders and banks anywhere in your library.

Mount Drives

This utility instructs the E4K to check the SCSI bus for the presence of SCSI devices. Use this function whenever a connected SCSI device does not appear in the disk browser.

► To Mount Drives:

1. From the Disk Browser, press the **Utilities** function key (F1).
2. Press the **Mount** function key (F1). The E4K will mount all SCSI devices.

Copy System

From time to time the E4K operating system will be updated with new features and functions. This software is usually distributed on floppy disk and can be permanently copied into the E4K's Flash RAM so that it will automatically load whenever you turn on the E4K. Software can also be saved to a floppy disk in order to back it up.

Each version of software is numbered and is indicated when you select "About" under the "Utilities" menu in the Master module. Copying software will not affect any other data such as samples or presets.

► To Update the E4K Software:

1. Turn off power to the E4K.
2. Insert the software floppy disk with the label side up.
3. Turn on power to the E4K. The display will show the software version on the floppy and ask if you wish to update Flash RAM from the floppy software.
4. Press **Enter** to update, or **Exit** to cancel the operation.

► To Backup the E4K Software to Floppy Disk:

1. From the Disk Browser, select the floppy drive using the data entry control, cursor keys or inc/dec keys.
2. Press the **Utilities** function key (F1).
3. Press the **CopySys** function key (F2). The display will ask you to insert a floppy disk. Insert a formatted floppy disk with the label side toward the center of the E4K. (If the floppy disk is unformatted, the E4K will ask if you want to format it.)

4. Press **Yes**, remove the current disk, insert a new disk and press **OK**. Otherwise, press **Cancel** or **Exit** to cancel the operation and return to the disk browser.

Format Disk

Before a new floppy disk or hard disk can record or store any data, it must be told how to record this data. This is called formatting. The floppy disk formatting procedure should be run on any new disk, or on recycled disks previously used with other systems (such as personal computers) since these will not be formatted correctly for the E4K.

Formatting a hard disk or optical drive works exactly like formatting a floppy disk. If the hard disk drive is not shown in the disk browser, use the Mount Drive function. The hard disk or optical drive should now be displayed.



Disk

► To Format a Floppy Disk:

1. From the Disk Browser, select the floppy drive using the data entry control, cursor keys or inc/dec keys.
2. Press the **Utilities** function key (F1).
3. Press the **Format** function key (F3). The display will ask you to insert a floppy disk. Insert a floppy disk with the label side toward the center of the E4K.
4. Consider the implications of your action. Formatting a floppy disk erases all information on that disk, *completely*. Press **OK** to format the disk or **Cancel** to cancel the operation. Formatting takes about a minute and a half.
5. After formatting the floppy disk, format another if desired. The display will ask you if you want to format another floppy. To do this, press **Yes**, remove the current disk, insert a new disk and press **OK**. Otherwise, press **Cancel** or **Exit** to cancel the operation and return to the disk browser.

► To Format a Hard Disk or Optical Disk:

1. From the Disk Browser, select the desired SCSI drive using the data entry control, cursor keys or inc/dec keys.
2. Press the **Utilities** function key (F1).
3. Press the **Format** function key (F3). The display will warn you if you are about to destroy E4K data.

4. Press **OK** to format the disk or **Cancel** to cancel the operation. Formatting time varies depending on the size of the disk.

Install File System

Many new hard disk and optical drives as well as removable hard disk cartridges now come pre-formatted. This function allows you to install the E4K file system on pre-formatted hard disks without having to reformat the disk. This can save quite some time, especially with large capacity disks. To find out if a disk is pre-formatted, try installing the file system first. If this doesn't work, format the disk normally.

► To Install the File System:

1. From the Disk Browser, select the desired SCSI drive using the data entry control, cursor keys or inc/dec keys.
2. Press the **Utilities** function key (F1).
3. Press the **Install FS** function key (F4). The display will warn you if you are about to destroy E4K data.
4. Press **OK** to Install the file system on the disk or **Cancel** to cancel the operation. Installing the file system time takes a minute or more, depending on the size of the disk.

Backup

This function allows you to backup and restore a portion or the entire contents of the hard disk. You should develop the habit of backing up any and all important data or risk catastrophe at some future date. If you'd *hate* to lose it, **BACK IT UP!**

► To Backup your Hard Disk Data:

1. From the Disk Browser, select the SCSI drive you want to back up using the cursor keys, inc/dec keys or the data entry control.
2. Press the **Utils** function key (F1).
3. Press the **Backup** function key (F5). The display will warn you if you are about to overwrite the current bank in RAM.
4. Press **OK** to continue or **Cancel** to cancel the operation. The following screen will appear.

▣ Notes on Bank Compatibility:

1) E4K can load banks from E-IV, e-64, ESI-32, EIIIX, EIII, Emax II, Akai and Roland S-760 hard disks or CD-ROMs.

2) E4K cannot load banks from ESI-32, EIIIX, EIII, Emax II, Akai or Roland floppies.

3) If E4K backs up an ESI-32/EIIIX bank, the ESI-32/EIIIX will no longer be able to load it.



5. Select the destination drive using the inc/dec keys, or data entry control.
6. Move the cursor down to "Backup Type" and select the type of backup mode with the inc/dec keys or data entry control.

Your choices are:

- **All:** Transfers all banks from the source disk to the destination disk.
- **Range:** Transfers a selected range of banks from the source disk to the destination disk.
- **Incremental:** Transfers only those banks which have been modified since the last backup.

Incremental Backup works by turning on a "bit" (stored with the bank) whenever a bank is created or modified. Whenever you back-up the bank, the bit is turned off. Because the bit is turned off on the first backup, do not use incremental back-up if you want to make multiple back-up disks.

7. Move the cursor down to "Destination Bank Numbers" to select where the banks will be placed on the destination disk.

Your choices are:

- **Same as Source:** Copies the banks into the same numbered bank locations on the destination disk.
- **Use Empty:** Copies the banks into the lowest consecutive empty bank locations on the destination disk.

8. When you have made your choices, press **OK** to continue or **Cancel** to cancel the operation.



Tip: Use "Same as Source" when backing up to an ESI-32 or EIIIIX drive if you want these machines to see your E4K files. They will overwrite any files stored in those locations. The ESI-32 and EIIIIX cannot load E4K files, but the drive can be used for both machines. Use "Use Empty" if backing up to an ESI-32 or EIIIIX drive and you want the E4K files to be invisible to those machines. In this case, ESI or EIIIIX files will not be overwritten.

Choosing All or Incremental causes the backup to begin immediately. Choosing “Range”, causes the following screen to appear.

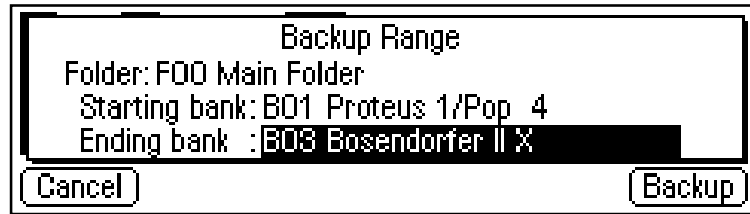

9. Select the Folder to be copied.
10. Select the starting and ending banks of the range to be copied, then press **Backup**.

► To Restore your Hard Disk Data:

Select your backup disk in the disk browser and simply backup to your regular work disk.

LOAD BANK

A bank can be loaded directly from the disk browser.

► To Load a Bank:

1. From the Disk Browser, press the **Load** function key (F4).
The following screen will appear:

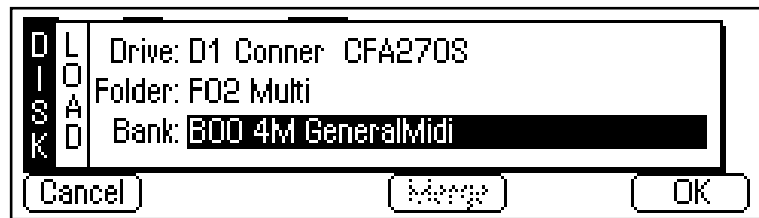

2. Choose a bank to load using the data entry control, the inc/dec keys or the numeric keypad. You may also change the current drive or folder by using the up/down cursor keys to select the drive or folder. Press **OK** to load the bank or **Cancel** to cancel the operation. If you pressed “OK” the bank will be loaded and the main preset selection screen will appear.

■ **Note:** EIII presets are translated into E4K presets as they are loaded. E4K voices are much bigger than EIII voices. By contrast, E4K sample zones within voices are tiny. At import/load time, E4K tries to collapse adjacent EIII voices into E4K voice+szones if it can (Envs, LFOs, etc. must be the same), otherwise, it creates **voices**. Therefore, EIII presets that use lots of differing voices really balloon in E-IV. Simpler presets (Proteus instrument type things - homogeneous) may collapse into a single voice.

- If there is a bank already loaded into the E4K, the Merge button will appear. Merge allows you to combine the new bank with the bank that was previously loaded.

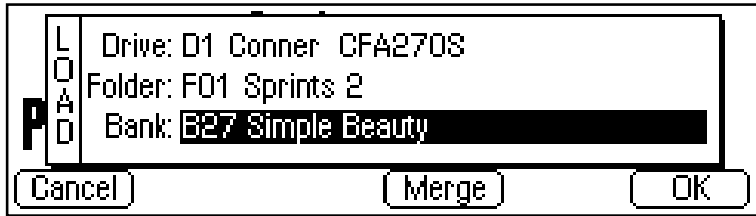

Caution: A "Memory Full" error will occur if you try to merge two banks which together contain more than ten sequences.

- Press **Merge** to combine the two banks of presets or **OK** to continue. If there isn't enough memory to hold both banks, the display will inform you that the resident bank is about to be destroyed.



SAVE BANK

A bank can be saved to disk from the disk browser.

► To Save a Bank:

- From the Disk Browser, press the **Save** function key (F5). The following screen will appear:



- Choose a location for the bank using the data entry control, the inc/dec keys or the numeric keypad. You may change the current drive or folder by using the up/down cursor keys to select the drive or folder. Press **OK** to load the bank or **Cancel** to cancel the operation. If you pressed "OK" the bank will be saved and the main preset selection screen will appear. If you are about to overwrite an existing bank, the display will warn you.

VIEW...

The display can be changed to a list format instead of the normal icon-based format.

► To Change the Display View:

From the Disk Browser, press the **View** function key (F3). The screen will change to a list format. The List view is shown below. Pressing the **View** function key again toggles the view back to icon view.

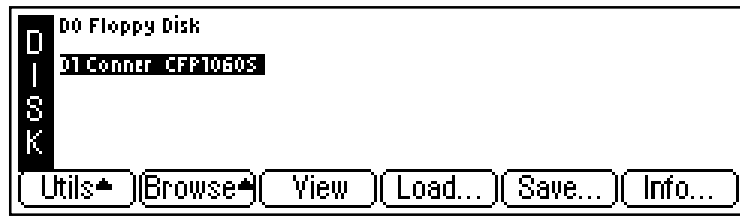

INFO...

This function displays information on the selected disk drive and also allows you to Lock the drive to prevent inadvertent erasure or tampering.

► To Get Disk Info:

From the Disk Browser, press the **Info...** function key (F6). A pop-up window will appear with the vital statistics of the selected disk.

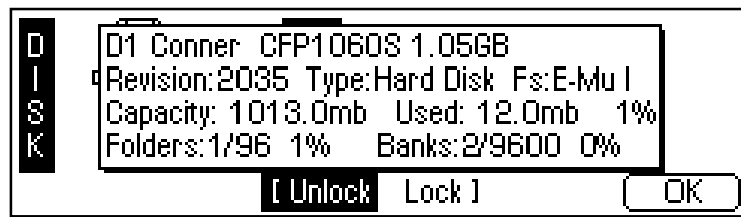

► To Lock or Unlock a Drive:

A disk drive can be locked and unlocked to protect it from inadvertent erasure or tampering.

1. To lock the selected disk, press **Function Key F4**, then press **OK (F6)**. The drive will be write protected until you unlock it.
2. To unlock the disk, press **Function Key F3**, then press **OK (F6)**.

❑ **Note:** The lock function actually locks the SCSI ID and not the drive. If you move a locked drive to another Emulator, it will be erasable.

FOLDER

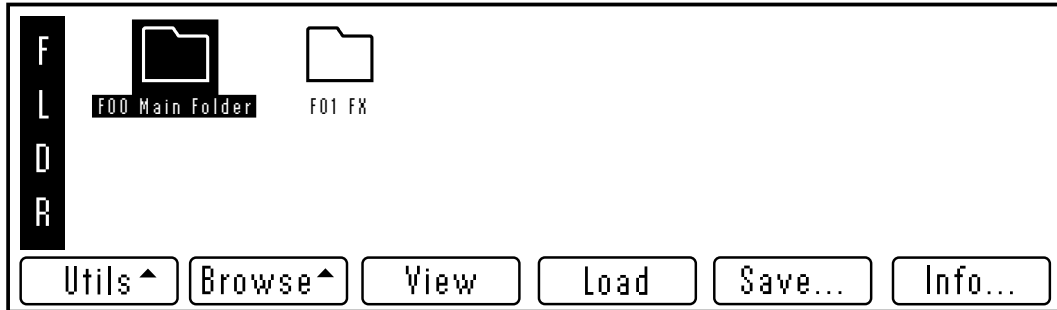

Folders help you organize your banks of sounds by providing another level between the bank and disk level. You may want to organize your banks by a particular project or by the type of sounds contained within, such as: Sound Effects, Pianos, Strings, etc. If you do not wish to use folders, simply place everything on the disk into one folder. You can skip over the folder level in the browser and forget that folders even exist.

FOLDER UTILITIES

The Folder Utilities menu contains several additional functions. Pressing the **Utils** function key (F1) from the folder browser enables a second row of soft keys.

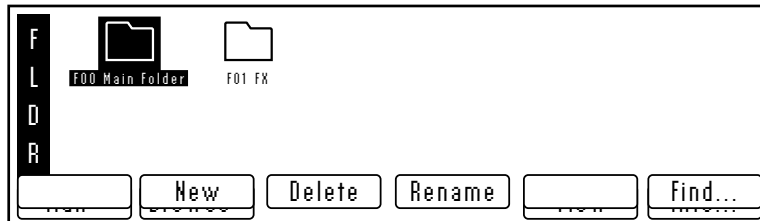

- **New:** Allows you to create a new folder.
- **Delete:** Allows you to delete an unwanted folder
- **Rename:** Allows you to rename the selected folder
- **Find:** Allows you to search the disk for a particular folder.

New

This utility allows you to create a new folder.

► To Create a New Folder:

1. From the Folder Browser, press the **Utilities** function key (F1).
2. Press the **New** function key (F2). A pop-up window will appear prompting you to name your new folder.
3. Press **OK** after naming the new folder and it will appear on the screen.

Delete

This utility allows you to delete a folder and all of its contents.

► To Delete a Folder:

1. From the Folder Browser, select the folder you wish to delete using the cursor keys, inc/dec keys or the data entry control.
2. Press the **Utilities** function key (F1).
3. Press the **Delete** function key (F3). A pop-up window will appear asking you if you want to delete the folder.
4. Press the **OK** function key (F6) to delete the folder and its contents or the **Cancel** function key (F1) to cancel the operation.

Rename

This utility allows you to rename a folder.

► To Rename a Folder:

1. From the Folder Browser, select the folder you wish to rename using the cursor keys, inc/dec keys or the data entry control.
2. Press the **Utilities** function key (F1).
3. Press the **Rename** function key (F4). A pop-up window will appear prompting you to rename the folder.
4. Change the name of the folder. Letters can be selected using the numeric pad, data entry control, inc/dec keys and cursor keys, or using an ASCII keyboard.

 **Tip:** The up/down cursor keys add and delete spaces when renaming. The tab key on an ASCII keyboard clears the entire name.

5. Press the **OK** function key (F6) to confirm the new name or the **Cancel** function key (F1) to cancel the operation.

Find...

This utility searches for folders, banks, presets, samples or sequences on the disk for a particular search string (a pattern of letters and numbers). If it finds the selected string anywhere in the name, the item will be selected. Use the Find utility again to find additional matching items.

► To Find:

1. From the Folder Browser, press the **Utils** function key (F1).
2. Press the **Find** function key (F6). The screen shown below will appear.

Search for: presets
Drive : all
Folder: all
Bank : all
Cancel String Search

3. Select the type of item (folder, bank, preset, sample or sequence) you wish to search for. If you have an idea of where the item is located, you can narrow the search by inputting additional data on the drive, folder or bank. Selecting "All" tells the E4K to search everything.
4. Press the **String** function key (F4), and enter the search string. Letters can be selected using the numeric pad, data entry control, inc/dec keys and cursor keys, or using an ASCII keyboard.
5. Press the **Search** function key (F6) to search for the item or the **Cancel** function key (F1) to cancel the operation.

VIEW

The display can be changed to a list format instead of the normal icon-based format.

► To Change the Display View:

From the Folder Browser, press the **View** function key (F3). The screen will change to a list format. Pressing the **View** function key again toggles the view back to icon view.

INFO...

The E4K can display information on the selected folder.

► To Get Folder Info:

From the Folder Browser, press the **Info...** function key (F6). A pop up window will appear with the vital statistics of the selected disk.

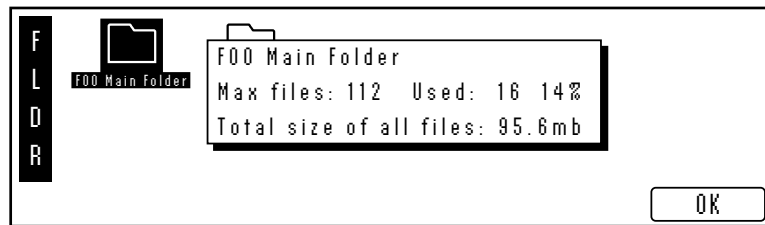

BANK

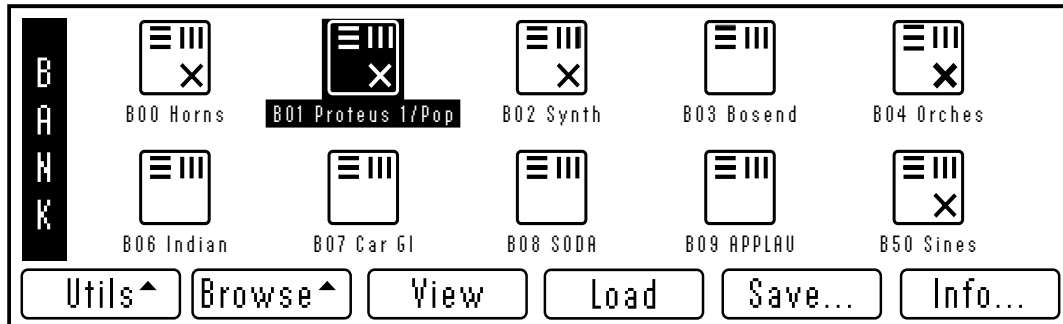

The Bank is a set of up to 1000 presets which can be loaded into and saved to disk from the E4K's internal memory (RAM). When you save to disk, that collection of presets, samples and sequences is a bank. Banks can be constructed as large as the memory in your E4K will allow (which in the case of 128 MB, is very large).

BANK UTILITIES

The Bank Utilities menu contains several additional functions. Pressing the **Utils** function key (F1) from the bank browser enables a second row of soft keys.

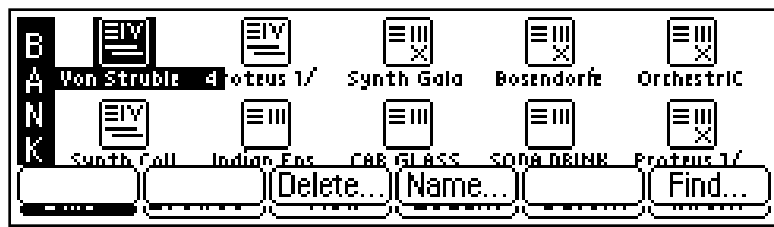

- **Delete:** Allows you to delete an unwanted bank.
- **Name:** Allows you to name or rename the selected bank.
- **Find:** Allows you to search the disk for a particular bank.

 **Tip:** The up/down cursor keys add and delete spaces when renaming. The tab key on an ASCII keyboard clears the entire name.

Delete

This utility allows you to delete an entire bank.

► To Delete a Bank:

1. From the Bank Browser, select the bank you wish to delete using the cursor keys, inc/dec keys or the data entry control.
2. Press the **Utilities** function key (F1).
3. Press the **Delete** function key (F3). A pop-up window will appear asking you if you want to delete the bank.
4. Press the **OK** function key (F6) to delete the bank or the **Cancel** function key (F1) to cancel the operation.

Name

This utility allows you to rename a bank.

► To Name a Bank:

1. From the Bank Browser, select the bank you wish to rename using the cursor keys, inc/dec keys or the data entry control.
2. Press the **Utilities** function key (F1).
3. Press the **Name** function key (F4). A pop-up window will appear prompting you to name the bank.
4. Change the name of the bank. Letters can be selected using the numeric pad data entry control, inc/dec keys and cursor keys, or using an ASCII keyboard.
5. Press the **OK** function key (F6) to confirm the new name or the **Cancel** function key (F1) to cancel the operation.

Find...

This utility searches your disk library for a particular pattern of letters and numbers (a search string). If it finds the string anywhere in the name, the bank will be selected. Use the Find utility again to find additional matching items.

► **To Find:**

1. From the Bank Browser, press the **Utilities** function key (F1).
2. Press the **Find** function key (F6). The screen shown below will appear.

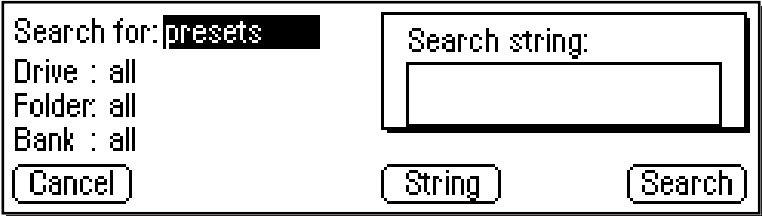

3. Select the type of item (folder, bank, preset, sample or sequence) you wish to search for. If you have an idea of where the item is located, you can narrow the search by inputting additional data on the drive, folder or bank. Selecting "All" tells the E4K to search everything.
4. Press the **String** function key (F4), and enter the search string. Letters can be selected using the numeric pad, data entry control, inc/dec keys and cursor keys, or using an ASCII keyboard.
5. Press the **Search** function key (F6) to search for the item or the **Cancel** function key (F1) to cancel the operation.

LOAD BANK

A bank can be loaded from the bank browser.

► **To Load a Bank:**

1. From the Bank Browser, select the bank you wish to load using the cursor keys, inc/dec keys or the data entry control.

⚠ Caution: A “Memory Full” error will occur if you try to merge two banks which together contain more than ten sequences.



2. Press the **Load** function key (F4).
3. Loading a bank overwrites the bank currently in memory unless you choose to Merge the banks.
4. Press **Yes** to overwrite the current bank or **Cancel** to cancel the operation.
5. Press **Merge** to add the new bank to the current bank in memory.
6. A pop-up dialog box will appear, prompting you to select the starting destination preset. Use the data entry control, inc/dec keys or the numeric pad to select the starting destination preset. As the new bank is merged, its presets will “fill in” any empty presets after this preset.

SAVE BANK

A bank can be saved to disk from the bank browser.

► To Save a Bank:

1. From the Bank Browser, press the **Save** function key (F5). The following screen will appear:

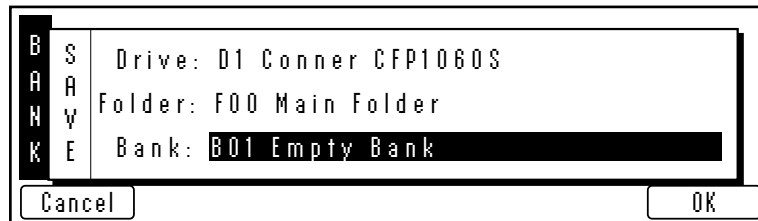

⚠ Tip: To save all the samples in a bank in EIIIx format, press and hold the decimal point key while you press the Save soft key. The display will offer you the option to save in EIIIx format.

[as EIIIx as EIV]

Note that the preset information is NOT transferred, only the samples.

2. Choose a location for the bank using the data entry control, the inc/dec keys or the numeric keypad. You may change the current drive or folder by using the up/down cursor keys to select the drive or folder. Press **OK** to load the bank or **Cancel** to cancel the operation. If you pressed “OK” the bank will be saved and the main preset selection screen will appear. If you are about to overwrite an existing bank, the display will warn you.
- If the bank contains SoundSprinted presets (presets in locations 990-999), the display will ask you if you want to save the SoundSprint presets along with the bank.

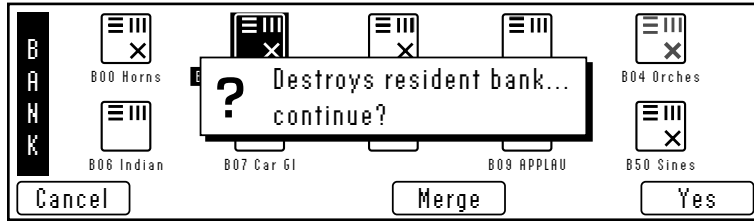

VIEW

The display can be changed to a list format instead of the normal icon-based format.

► To Change the Display View:

From the Bank Browser, press the *View* function key (F3). The screen will change to a list format. Pressing the **View** function key again toggles the view back to icon view.

INFO...

The E4K can display information on the selected bank.

► To Get Bank Info:

1. From the Bank Browser, press the **Info...** function key (F6). A pop up window will appear with the vital statistics of the selected bank.

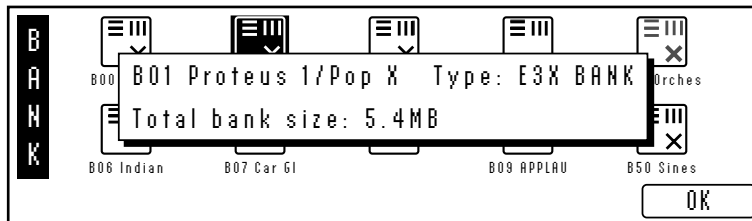

2. Press **OK** to return to the bank browser.



PRESET

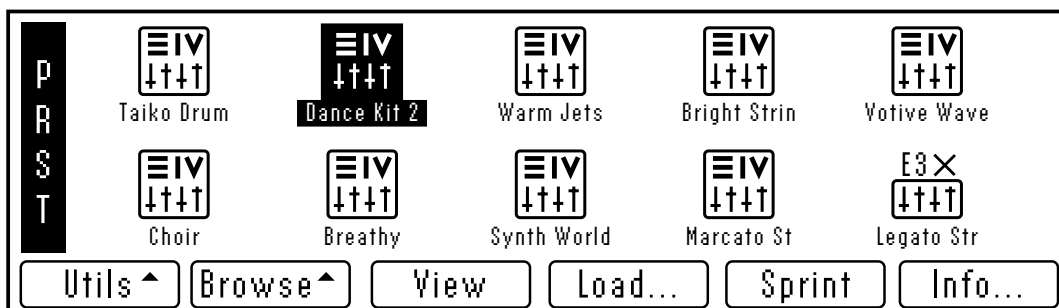

A preset is one complete keyboard setup containing voices and samples arranged on the keyboard together with all programmable synthesizer parameters.

UTILITIES

The Utilities menu contains two functions. Pressing the Utils function key (F1) from the preset browser enables a second row of soft keys.

- **Sprint:** Toggles SoundSprint™ mode on and off.
- **Find:** Allows you to search the disk for a particular bank.

Sprint

This option toggles SoundSprint mode (or auto preset load) on and off. SoundSprint is a special browser mode which automatically loads a preset as it is selected in the preset browser. The currently loaded preset remains active until the new preset is loaded.

Presets loaded via SoundSprint are placed at the top of the bank memory and are assigned preset numbers 990-999. Up to 10 Sprint presets can reside in RAM and can be instantly selected. Loaded presets remain in RAM until ten Sprint presets have been loaded or if memory capacity has been exceeded, at which time the oldest sprint preset is erased. (*Sprint will not erase the current preset.*)

A “Memory Full” message will be displayed if the new preset cannot load without overwriting the current preset. This message may also appear if you have a conventional bank loaded.

 **Caution:** *Linked presets are not loaded using SoundSprint. Only the selected preset will be loaded.*

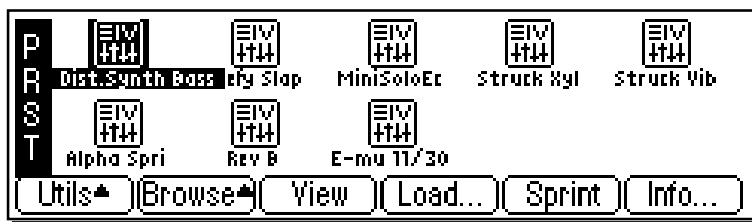

Tip: Sprint mode can also be accessed from the main menu bar. Simply press Sprint (F3) to instantly jump into SoundSprint mode.

► To Turn SoundSprint Mode On:

Press the **Sprint** function key (F5). The SoundSprint screen will appear and the selected preset will be automatically loaded.

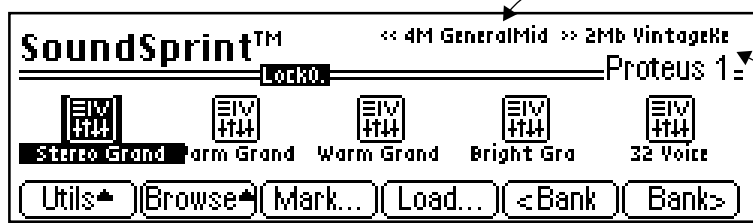

Other banks which are accessible by pressing the Bank function keys (F5 and F6).

► To Turn SoundSprint Mode Off:

1. From the SoundSprint Browser, press the **Utilities** function key (F1).
2. Press the **SprntOff** function key (F5). The Preset Browser screen will appear and SoundSprint mode will be turned off.

► To Select Presets using SoundSprint:

1. From the SoundSprint Browser, select presets in the normal way using the left/right cursor keys. The selected preset will automatically begin loading as soon as it is selected.
2. Press the a **Page** key to selected another page of presets. An illuminated red arrow beside the page key indicates if there is another page of presets in that direction.
3. At the top of the SoundSprint menu there may be other banks listed as in the screen shown above. These banks may be selected using the **<Bank** and **Bank>** function keys (F5 and F6).

Tip: Pressing the Disk Key can either call up SoundSprint mode or the Last screen you used in the Disk Browser.

You can set the Disk key function under, **Master, Setup, Misc.**



Bookmarks

When in SoundSprint mode, you can attach Bookmarks to your favorite presets so that they can be instantly selected with a single or double key press. Up to 100 bookmarks can be stored and saved to nonvolatile EEPROM.

► To Set a Bookmark:

1. From the SoundSprint Browser, select the preset you wish to bookmark using the left/right cursor keys.
2. Press the **Mark...** function key (F3). The following screen will appear.

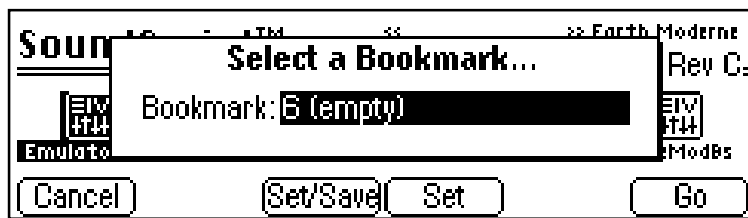

3. Select a bookmark location using the data entry control or inc/dec keys.
 4. After selecting a location, press the **Set** function key (F4) to set the bookmark. Press the **Set/Save** function key (F3) if you want to save the bookmarks to nonvolatile memory.
- The numeric keypad selects a bookmark from the rank of 10 you last selected with the Lock engaged.
5. Press the **Go** function key (F6) to go to the currently selected preset.
 6. Press **Cancel** (F1) to cancel the operation.

Tip: *Nonvolatile memory is retained even with the power turned off.*

► Alternate Method to Set a Bookmark:

1. From the SoundSprint Browser, select the preset you wish to bookmark using the left/right cursor keys.
2. Press and hold the **Set** key located to the right side of the numeric keys. While holding the Set key, press one of the numeric keys. A pop up dialog box will inform you that the bookmark is set.

Note: *The alternate bookmark setting method can only set bookmarks 0-9 of the current rank.*

► **To Select a Bookmark:**

1. From the SoundSprint Browser, simply press the numeric key(s) corresponding to the bookmark you wish to select. For example, if you wanted to select the preset at bookmark number 9, press 9 on the numeric keys. The preset will be selected.
2. The **Lock** key the first digit of the two digit bookmark number. Press and hold the **Lock** key (located to the left of the numeric keys) while pressing one of the numeric keys to lock the most significant digit. Press the Lock key by itself to turn Lock mode On or Off. The lock indicator on the display is shown below.

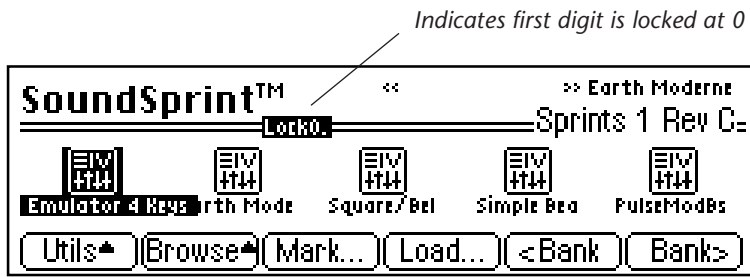

3. With Lock Off, two digits must be entered to select a bookmark. For example, to select bookmark 9, you would press 0, then 9.
4. With the most significant digit locked, only one key press is required to select a bookmark.
5. **To select another rank of 10 bookmarks**, press and hold the Lock key and press one of the numeric keys. The display will inform you which rank of 10 bookmarks is now selected.

Find...

This utility searches your disk library for a particular pattern of letters and numbers (a search string). If it finds the selected string anywhere in the name, the bank will be selected. Use the Find utility again to find additional matching items.

► To Find:

1. From the Preset Browser, press the **Utilities** function key (F1).
2. Press the **Find** function key (F6). The screen shown below will appear.
3. Select the type of item (folder, bank, preset, sample or sequence) you wish to search for. If you have an idea of where the item is located, you can narrow the search by inputting additional data on the drive, folder or bank. Selecting "All" tells the E4K to search everything.
4. Press the **String** function key (F4), and enter the search string. Letters can be selected using the numeric pad, data entry control, inc/dec keys and cursor keys, or using an ASCII keyboard.
5. Press the **Search** function key (F6) to search for the item or the **Cancel** function key (F1) to cancel the operation.

LOAD PRESET

An individual preset can be loaded into the bank from the preset browser. This is a way you can create your own custom banks. Simply load in the desired presets, then save the bank to disk.

► To Load a Preset:

1. From the Bank Browser, select the bank containing the preset you wish to load using the cursor keys, inc/dec keys or the data entry control.
2. From the Preset Browser, select the preset you wish to load.
2. Press the **Load** function key (F4). A pop-up window will prompt you to select the destination preset.

4. Choose a location for the preset using the data entry control, the inc/dec keys or the numeric keypad. You may overwrite an existing preset or choose an empty preset as the destination.
5. Press **OK** to load the selected preset or **Cancel** to cancel the operation.

VIEW

The display can be changed to a list format instead of the normal icon-based format.

► To Change the Display View:

From the Preset Browser, press the **View** function key (F3). The screen will change to a list format. Pressing the **View** function key again toggles the view back to icon view.

INFO...

The E4K can display information on the selected preset.

► To Get Preset Info:

1. From the Preset Browser, press the **Info...** function key (F6). A pop up window will appear with the vital statistics of the selected preset.

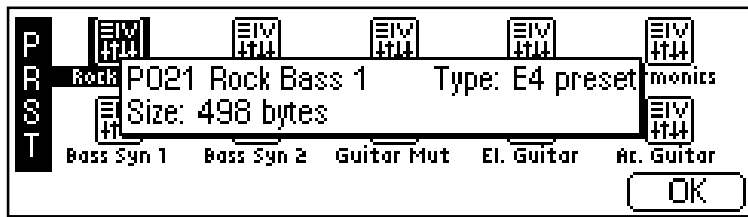

2. The preset size indicates the amount of memory that the programmable preset parameters occupy. It does not include the samples used in the preset. Press **OK** to return to the preset browser.

SAMPLE

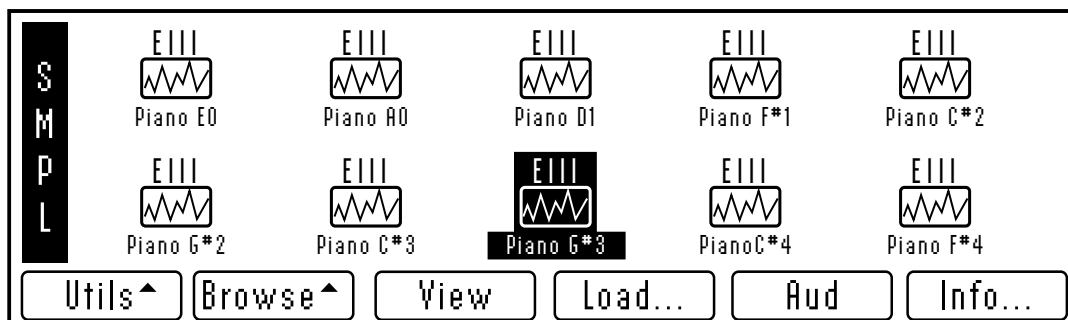

A sample is the most basic sound element of the E4K and consists of the digitized sound together with truncation and looping parameters.

UTILITIES

The Utilities menu contains several additional functions. Pressing the **Utils** function key (F1) from the sample browser enables a second row of soft keys. Only one option is currently implemented.

- **Find:** Allows you to search the bank for a particular sample.

Find...

This utility searches your disk library for a particular pattern of letters and numbers (a search string). If it finds the selected string anywhere in the name, the bank will be selected. Use the Find utility again to find additional matching items.

► To Find:

1. From the Sample Browser, press the **Utils** function key (F1).
2. Press the **Find** function key (F6). The find screen (shown on the following page) screen will appear.



3. Select the type of item (folder, bank, preset, sample or sequence) you wish to search for. If you have an idea of where the item is located, you can narrow the search by inputting additional data on the drive, folder or bank. Selecting “All” tells the E4K to search everything.
4. Press the **String** function key (F4), and enter the search string. Letters can be selected using the numeric pad, data entry control, inc/dec keys and cursor keys, or using an ASCII keyboard.
5. Press the **Search** function key (F6) to search for the item or the **Cancel** function key (F1) to cancel the operation.

VIEW

The display can be changed to a list format instead of the icon-based format.

► To Change the Display View:

From the Sample Browser, press the **View** function key (F3). The screen will change to a list format. Pressing the **View** function key again toggles the view back to icon view.

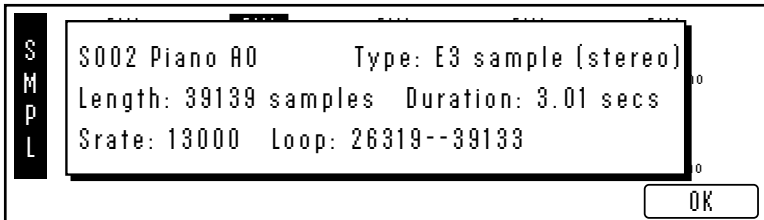

LOAD SAMPLE

An individual sample can be loaded into the bank from the sample browser. This is an easy way to create your own custom presets. Simply load in the desired samples, build your preset, then save the bank to disk.

► To Load a Sample:

1. From the Bank Browser, select the bank containing the preset you wish to load using the cursor keys, inc/dec keys or the data entry control.
2. From the Sample Browser, select the sample you wish to load.
3. Press the **Load** function key (F4). A pop-up window will prompt you to select the destination sample.
4. Choose a location for the sample using the data entry control, the inc/dec keys or the numeric keypad. You may overwrite an existing sample or choose an empty sample as the destination.
5. Press **OK** to load the selected sample or **Cancel** to cancel the operation.

AUDITION

The currently selected sample can be played directly from the hard disk before loading.

► To Audition a Sample:

From the Sample Browser, press the **Audition** function key (F5). A pop up dialog box will appear and the sample will be auditioned directly from the disk.

INFO...

The E4K can display vital information on the selected sample.

► To Get Sample Info:

1. From the Sample Browser, press the **Info...** function key (F6). A pop up window will appear with information about the selected sample.
2. The window indicates: sample length, duration in seconds, the sample rate, and the loop points in samples. Press **OK** to return to the sample browser.

SEQUENCE

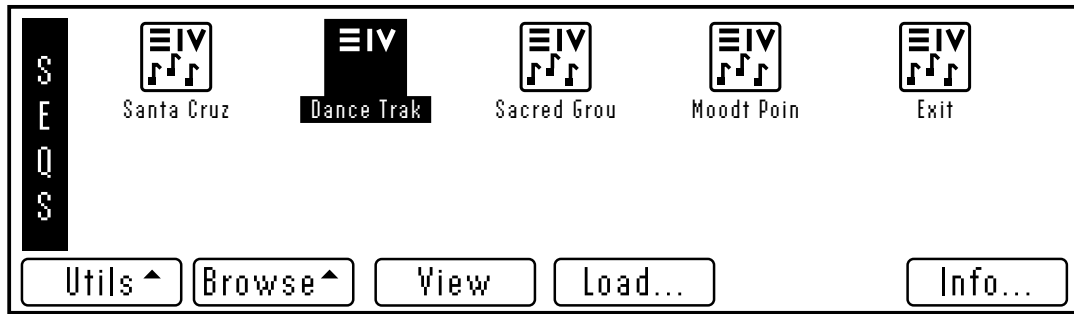

Up to ten sequences can be loaded into a bank or saved to disk as part of a bank. When you **Save** to disk, you are saving all presets, samples and sequences currently residing in RAM. Sequences do not appear in the sequence browser until you have saved the bank to disk.

SEQUENCE UTILITY

The Bank Utilities menu contains only one function — Find. Pressing the **Utils** function key (F1) from the bank browser enables a second row of soft keys.

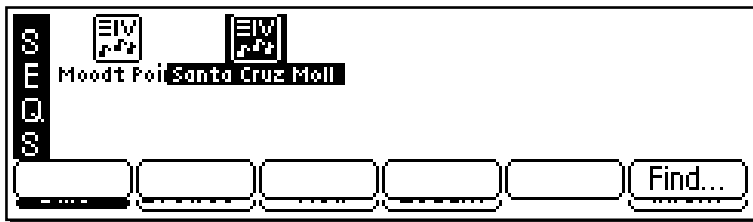

- **Find:** Allows you to search the disk for a particular bank.

FIND...

This utility searches your disk library for a particular pattern of letters and numbers (a search string). If it finds the selected string anywhere in the name, the bank will be selected. Use the Find utility again to find additional matching items.

► To Find:

1. From the Sequence Browser, press the **Utilities** function key (F1).
2. Press the **Find** function key (F6). The screen shown below will appear.

Search for: **sequences**
 Drive : D1 Conner QFA27
 Folder: F02 Multi
 Bank : B00 4M GeneralMid

Search string:

3. Select the type of item (folder, bank, preset, sample or sequence) you wish to search for. If you have an idea of where the item is located, you can narrow the search by inputting additional data on the drive, folder or bank. Selecting "All" tells the E4K to search everything.
4. Press the **String** function key (F4), and enter the search string. Letters can be selected using the numeric pad, data entry control, inc/dec keys and cursor keys, or using an ASCII keyboard.
5. Press the **Search** function key (F6) to search for the item or the **Cancel** function key (F1) to cancel the operation.

VIEW

The display can be changed to a list format instead of the icon-based format.

► To Change the Display View:

From the Sequence Browser, press the **View** function key (F3). The screen will change to a list format. Pressing the **View** function key again toggles the view back to icon view.

LOAD SEQUENCE

An individual E4K sequence can be loaded from another bank using the sequence browser. Simply load in the desired sequences, then save the bank to disk. Sequences can be either Emulator sequences or Standard MIDI Files.

► **To Load a Sequence from another Bank:**

If you wish to load an E4K sequence from another bank into the current bank perform the following steps.

1. From the Disk Browser, select the drive and bank containing the sequence you wish to load using the cursor keys, inc/dec keys or the data entry control.
2. From the Sequence Browser, select the sequence you wish to load.

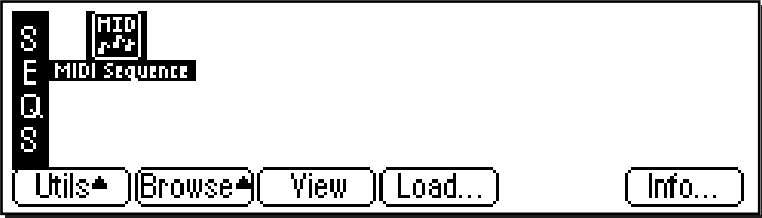

3. Press the **Load** function key (F4). A pop-up window will prompt you to select the destination sequence.
4. Choose a location for the sequence using the data entry control, the inc/dec keys or the numeric keypad. You may overwrite an existing sequence or choose an empty sequence as the destination. There are ten possible sequence locations.
5. Press **OK** to load the selected sequence or **Cancel** to cancel the operation.

INFO...

Displays information about the selected sequence.

► **To Get Sequence Info:**

1. From the Sequence Browser, press the **Info...** function key (F6). A pop up window will appear with information about the selected sequence.
2. The window indicates: sequence number, size in bytes, and type (either E-IV or Standard MIDI File).

► To Load a Standard MIDI File from Floppy Disk:

The E4K can load and play Standard MIDI File sequences (*type 0 or 1*). Sequence files should conform to PC DOS format using a DOS formatted disk and using the following format for the file name: **12345678.MID** (up to eight characters followed by “.MID”). It is important to note that Standard MIDI Files appear as **Banks**, NOT as sequences in the sequence browser.

1. Insert a DOS formatted floppy disk containing the Standard MIDI Files.
2. From the Disk Browser, select the floppy drive.
3. Press Browse again and select **Banks**. The MIDI sequences will appear as banks.

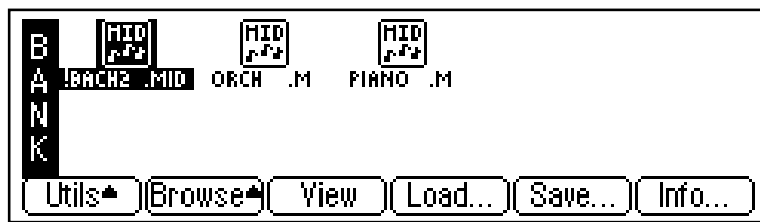

4. Press the **Load** function key (F4). A pop up dialog box will appear warning you that loading will destroy the resident bank.
5. Press the **Merge** key (F4). The selected sequence will be merged into the current bank, and will be placed in the first empty sequence location.
6. Press **OK** to load the selected sequence or **Cancel** to cancel the operation.

Important Information for Loading Standard MIDI Files

- Use PC DOS formatted diskettes to load from floppy. Disks can be formatted on either the Mac or PC.
- To be readable by the E4K the file MUST have 0-8 characters, then a period, then “MID”. (*The “MID” part must be all capital letters.*) **Example:** 12345678.MID

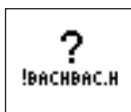

Tip: If the file name does not conform to the proper format, the question mark icon shown below will appear. Rename the file according to the file name requirement using the “Name Bank” function. The icon will look normal and the sequence will merge properly.



Master Menu

Memory Statistics	77	Sequencer Manage	107
Utilities Menu	78	MIDI Globals	109
<i>Assignable Keys</i>	78	<i>Mode</i>	110
<i>Channel Volume</i>	79	<i>Basic Channel</i>	110
<i>Tones</i>	80	<i>Mode Select</i>	111
<i>Recalibration</i>	80	<i>Local Control</i>	112
<i>Test Access</i>	82	<i>Effects Control</i>	113
<i>About the E4K</i>	82	<i>MIDI Mix</i>	115
Bank Menu	83	<i>MIDI Controllers 1 & 2</i>	117
<i>Erase Bank</i>	83	<i>MIDI Preferences 1 & 2</i>	119
<i>Name Bank</i>	84	<i>Velocity Curve</i>	119
<i>Auto Load Bank</i>	84	<i>Controller #7 Sensitivity</i>	120
Setup Menu	85	<i>Controller #7 Curve</i>	120
<i>Tuning</i>	86	<i>Global Pedal Override</i>	121
<i>Output</i>	88	<i>Receive Program Change</i>	121
<i>Miscellaneous</i>	93	<i>Send Program Change</i>	122
<i>Import Options</i>	100	<i>Magic Preset</i>	122
FX Menu	103		
<i>Master Effects A</i>	103		
<i>Master Effects B</i>	106		

Memory Statistics

Memory Statistics				
Type	Total	Used		
Preset	517k	384k	74%	
Sample	4mb	3.86mb	96%	

Utils* Bank* Setup* FX* SeqMgr MIDI*

The Master Menu contains functions which affect the entire machine, not just certain presets or banks, such as overall tuning, LCD contrast, MIDI modes, master effects, etc.

The main screen shows the E4K's internal memory status. There are two types of memory in the E4K, preset memory and sample memory. An E4K contains around half a megabyte of preset memory. The amount of sample memory can vary from 4 megabytes to 128 megabytes. Preset/Sequencer memory is used to hold the preset parameter information and sequencers and this ratio is user adjustable. Sample memory contains the actual samples. Presets and sequences require much less memory than samples, so you are not likely to run out of preset memory, even when creating huge banks.

The master menu contains six main sub menus:



- **Utilities** - Controls for the assignable keys, test tones and volume control recalibration. Also contains the channel status indicator, credits and software version display.
- **Bank** - Allows you to name or erase the bank and set a bank to be auto-loaded on power-up.
- **Setup**- Contains four submenus: Tune, Output, Miscellaneous, and Import functions
- **FX**- Contains the digital effect processor functions.
- **Sequence Manage** - Contains sequencer related functions.
- **MIDI** - Contains global MIDI controls, velocity curve and other miscellaneous MIDI functions.

 **Tip:** The Master settings are saved into flash RAM when you exit the module.

Master

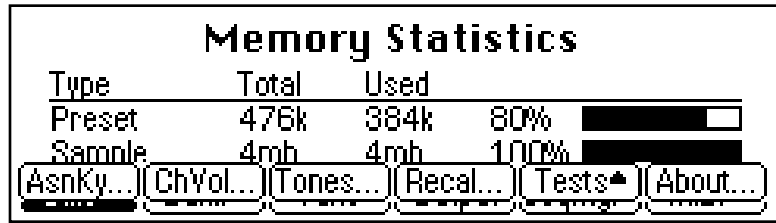
Utilities



Type	Total	Used	
Preset	476k	384k	80% 
Sample	4mb	4mb	100% 

(AsnKy...) (ChVol...) (Tones...) (Recal...) (Tests▲) (About...)

The Master Utilities menu contains several additional functions.

- Assignable Keys
- Channel Volume
- Reference Tones
- Recalibration
- Test Access
- About the Emulator Four Keyboard

ASSIGNABLE KEYS

The three assignable keys on the front panel can be programmed to call up any almost any screen with a single key press. This saves you from having to page through multiple menus to find the screen you want to edit. The assignable keys can be programmed either from the assignable keys screen or directly from any screen you are working in.

► To Program the Assignable Keys from the Master Menu

1. Press the **Master** key. The LED will illuminate and the Memory Statistics screen will appear.
2. Press the **Utilities** function key (F1). A second row of soft keys will appear.
3. Press the **AsnKy** function key (F1). The following screen will appear.

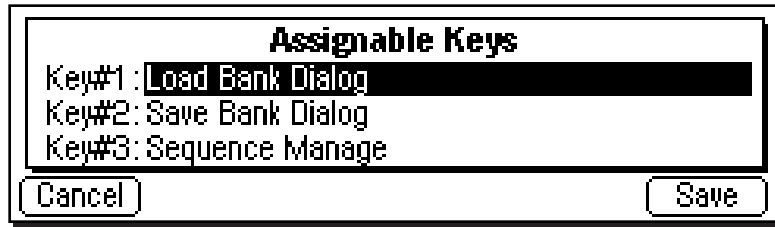

4. Use the data entry control or the inc/dec keys to change the screen associated with each assignable key.
5. Press **Save** to store the assignable keys settings and return to the Memory Statistics screen.
6. Press **Cancel** to cancel the operation and return to the Memory Statistics screen.

► **To Program an Assignable Key from the Current Screen**

This method allows you to link an assignable key to the screen you are currently in.

1. Press and hold one of the assignable keys from any screen in the E4K.
2. After two seconds a pop up window will appear, informing you that the assignable key has been programmed for the current screen.



CHANNEL VOLUME

This function calls up a bar graph display showing the volume of all 64 output channels of the E4K. If the optional channel expansion board (model 6910) is installed, 128 channels will be displayed. The channel status display is a useful indicator of your channel usage. The 64 channels of the E4K are assigned in a circular order, (i.e. 1, 2, 3... 64, then back to 1). Channels become available for reassignment when their output volume falls below a certain level.

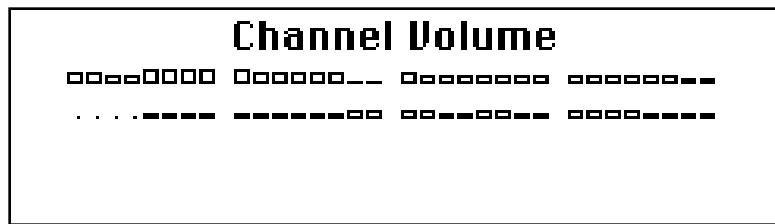

TONES

This function generates accurate reference tones which can be used to troubleshoot your audio system without loading a bank or can be used to test each output of the E4K.

► To Enable the Reference Tone

1. Press the **Master** key. The LED will illuminate and the Memory Statistics screen will appear.
2. Press the **Utilities** function key (F1). A second row of soft keys will appear.
3. Press the **Tones...** function key (F3). The following screen will appear.

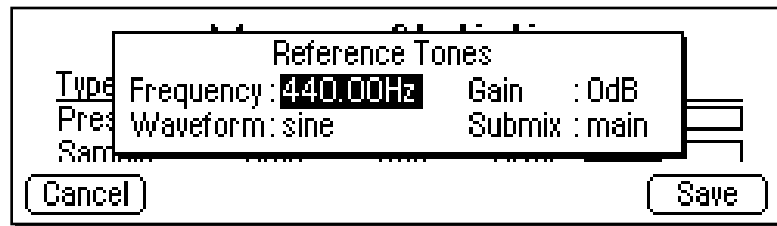

4. Adjust the frequency, waveform, gain, and the output submix channel using the data entry control or inc/dec keys.
5. Press **Exit** to return to the Memory Statistics screen.

RECALIBRATION

This screen allows you to recalibrate the front panel volume control, rotary encoder and the control wheels on the E4K. The controls should be recalibrated periodically in order to compensate for normal wear and tear on the controls themselves or if the controls ever behave strangely.

► To Recalibrate

1. Press the **Master** key. The LED will illuminate and the Memory Statistics screen will appear.
2. Press the **Utilities** function key (F1). A second row of soft keys will appear.
3. Press the **Recal...** function key (F4). The following screen will appear.

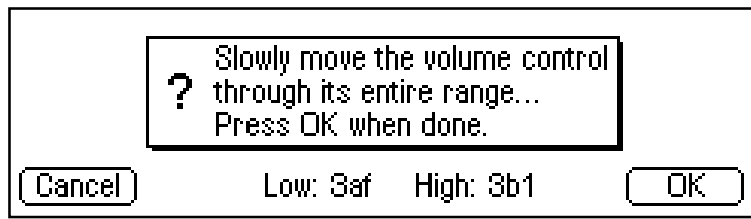

4. Follow the instructions and adjust the volume slider to the minimum and maximum position, then press OK.
5. The display will say, "Saving System" and the following recalibration screen will appear.

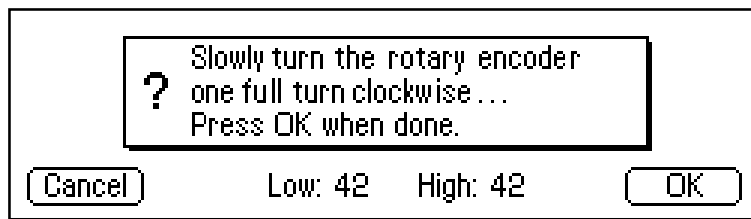

6. Move the encoder approximately one revolution, then press OK.
7. Again, the display will say, "Saving System" and the next recalibration screen will appear.

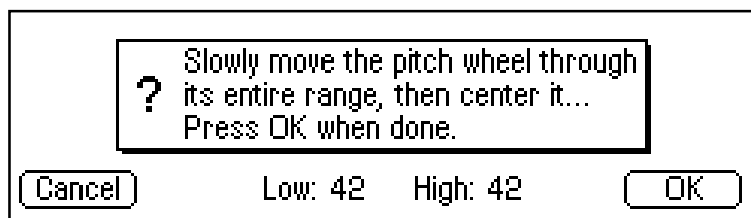

8. Follow the instructions and move the pitch wheel as directed, then press OK.
9. The display will say, "Saving System" and the last recalibration screen will appear.

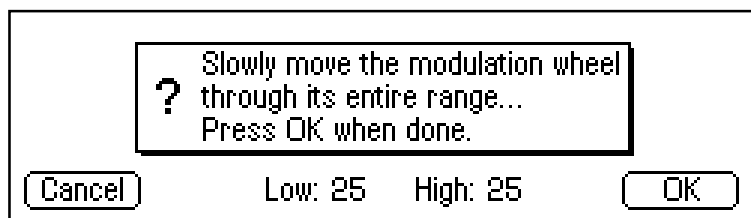

10. Follow the instructions and move the mod wheel as directed, then press OK.
11. You can press **Cancel** during any of the recalibrations to skip that particular control and move on to the next one.

TEST ACCESS

This screen provides access to the Service Center diagnostic routines. **CAUTION:** Some of the diagnostic routines have the potential to destroy the data on your hard disk. It is for this reason that the diagnostics are protected from casual use by a secret password.

► To Access the Diagnostic Access Screen

1. Press the **Master** key. The LED will illuminate and the Memory Statistics screen will appear.
2. Press the **Utilities** function key (F1). A second row of soft keys will appear.
3. Press the **Tests** function key (F5). A pop up dialog box will appear asking for the diagnostics password.
4. Enter the proper password (1-3-5-8) then press OK to enter the diagnostics menus.



ABOUT THE EMULATOR FOUR KEYBOARD

This screen displays the current software version resident in the E4K. It also credits the creators of the E4K and displays the phone number to order additional sounds.

► To List the Software Version

1. Press the **Master** key. The LED will illuminate and the Memory Statistics screen will appear.
2. Press the **Utilities** function key (F1). A second row of soft keys will appear.
3. Press the **About...** function key (F6). A pop-up dialog box lists the resident software version.
4. Press **Exit** to return to the Memory Statistics screen.

Bank

Type	Total	Used	
Preset	543k	113k	20% 
Sample	8mb	4mb	50% 
Erase...	Name...	Auto...	

The Bank submenu currently contains three functions, which allow you to name and erase the bank and automatically load a bank on power up.

ERASE BANK

Erasing a bank erases ALL the memory in RAM which includes all samples, voices and presets. Erasing the bank does not erase anything stored on your hard disk, only the contents of the E4K's RAM.

► To Erase the Bank:

1. Press the **Master** key. The LED will illuminate and the Memory Statistics screen will appear.
2. Press the **Bank** function key (F2). A second row of soft keys will appear.
3. Press the **Erase...** function key (F1). A pop-up dialog box will appear asking you if you want to erase all presets and samples.
4. Press the **OK** to erase the bank or **Cancel** to cancel the operation.

Master

NAME BANK

This utility allows you to name the current bank.

► To Name the Bank:

1. Press the **Master** key. The LED will illuminate and the Memory Statistics screen will appear.
2. Press the **Bank** function key (F2). A second row of soft keys will appear.
3. Press the **Name...** function key (F2). A pop-up dialog box will appear asking you to enter the new bank name.
4. Name the bank. Letters can be selected using the numeric keypad, data entry control, inc/dec keys and cursor keys, or using an ASCII keyboard.
5. Press **OK** to name the bank or **Cancel** to cancel the operation.

AUTO BANK LOAD

This function automatically loads the selected bank whenever the E4K is first powered up.

► To Set the Auto Load Bank:

1. Press the **Master** key. The LED will illuminate and the Memory Statistics screen will appear.
2. Press the **Bank** function key (F2). A second row of soft keys will appear.
3. Press the **Auto...** function key (F3). The pop-up dialog box shown below will appear.

★ Caution: *Auto Bank Load works on bank numbers, not their names. If you move a bank to another location or switch removable media, the bank may not load or the wrong bank may be loaded on power-up.*

Bank Auto-Load	
Drive :	01 Conner CFP10608
Folder:	F00 Main Folder
Bank :	B06 Indian Ensemble
<input type="button" value="Cancel"/>	<input type="button" value="Save"/>

4. Set the bank to be automatically loaded on power up. Banks can be selected using the numeric keypad, data entry control, inc/dec keys and cursor keys.
5. Press **Save** to confirm your choice or **Cancel** to cancel the operation.

Setup

Type	Total	Used	
Preset	504k	0k	0%
Sample	8mb	6,210kb	77%

Tune Output Misc Import Memory

The Setup menu contains four additional submenus.

- **Tune** - Contains three functions: tuning offset, transposition and audition key.
- **Output** - Contains several functions related to the audio and S/PDIF output levels.
- **Miscellaneous** - Contains eight miscellaneous and unrelated functions.
- **Import Options** - Contains preferences and controls for importing samples and presets from Akai™ or Roland™ samplers.
- **Memory Configuration** - Allows you to control the amount of RAM allocated between the sequencer and presets.

Master

TUNE

This submenu contains three functions related to master tuning.

TUNING OFFSET

Tuning Offset adjusts the overall tuning of the E4K so that it can be tuned to other instruments. The range of tuning offset is ± 100 cents or 1 semitone in approximately 1.2 cents increments.

► To Change the Tuning Offset.

1. Press the **Master** key. The LED will illuminate and the Memory Statistics screen will appear.
2. Press the **Setup** function key (F3). A second row of soft keys will appear.
3. Press the **Tune** function key (F1). The screen shown below will appear.

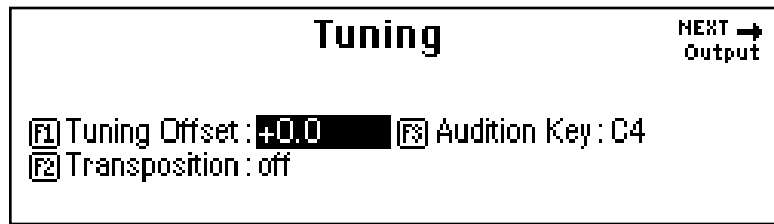

4. If it is not already there, move the cursor to the tuning offset amount using the cursor keys or by pressing the F1 key.
5. Adjust the tuning offset of the E4K using the data entry control, or inc/dec keys.
6. Press the **Exit** key twice to return to the Memory Statistics screen.

TRANSCOPE

This function transposes the E4K in half-step intervals. The range of transposition is ± 1 octave. Transpose allows you to play in a different key without having to use different fingerings. Transpose will also allow you to play beyond the range of the physical keyboard.

► To Change the Transposition:

1. Press the **Master** key. The LED will illuminate and the Memory Statistics screen will appear.
2. Press the **Setup** function key (F3). A second row of soft keys will appear.
3. Press the **Tune** function key (F1). The Tuning screen will appear.
4. Move the cursor to the transposition amount using the cursor keys or by pressing the F2 key.
5. Adjust the transposition of the E4K using the data entry control, or inc/dec keys.
6. Press **Exit** twice to return to the Memory Statistics screen.

★ Caution: Turn off transposition before selecting or modifying any presets to prevent confusion. Transpose transposes the key number rather than the sample assignment. Selecting the zone and any other use of the keyboard will show the transposed key number.

Master

AUDITION KEY

This function allows you to set the key that will be played when the ASCII keyboard controlled audition function (Control, A) is invoked. Note: The raw sample (at the original pitch) will be played if you audition from any sample-related screen (Sample Manage, Sample Edit, Disk Sample Browser).

► To Change the Audition Key:

1. Press the **Master** key. The LED will illuminate and the Memory Statistics screen will appear.
2. Press the **Setup** function key (F3). A second row of soft keys will appear.
3. Press the **Tune** function key (F1). The Tuning screen will appear.
4. Move the cursor to the audition key field using the cursor keys or by pressing the F3 key.
5. Select the audition key using the data entry control, inc/dec keys or the keyboard.
6. Press **Exit** twice to return to the Memory Statistics screen.

Tip: The headroom adjustment also controls the level of the digital audio output.

OUTPUT

The Output submenu contains functions dealing with the E4K's audio and digital outputs.

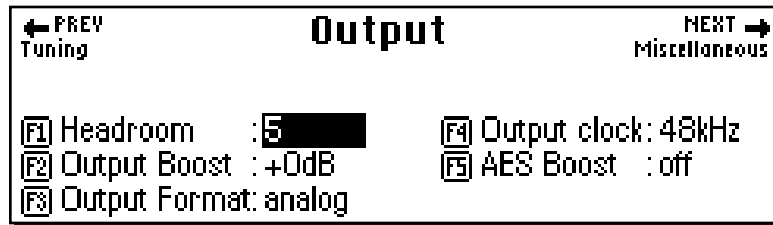

HEADROOM

Headroom is the amount of dynamic range remaining before clipping will occur. Think of a tall person (the signal) in a small room. Raising the ceiling would increase the headroom.

A sampling musical instrument, unlike a CD player, must play multiple channels at once. Each additional channel boosts the headroom requirement by 3 dB.

The amount of headroom on the E4K is adjustable from 0 dB to 15 dB in 1 dB increments (with the front panel volume control set to maximum). A headroom setting of 0 dB for example, will provide the hottest output level, (and the highest signal to noise ratio) but may produce “clipping” if too many notes are played at once. The default headroom setting on the E4K is +3 dB, which maintains an excellent signal to noise ratio while keeping a reasonable amount of headroom in reserve. If you hear the signal clipping or breaking up, increase the amount of headroom. **The headroom adjustment also controls the level of the S/PDIF digital output.** Press Exit after setting the headroom to store the setting in EEPROM.

► To Change the Headroom:

1. Press the **Master** key. The LED will illuminate and the Memory Statistics screen will appear.
2. Press the **Setup** function key (F3). A second row of soft keys will appear.
3. Press the **Output** function key (F2). The Output menu shown above will appear.

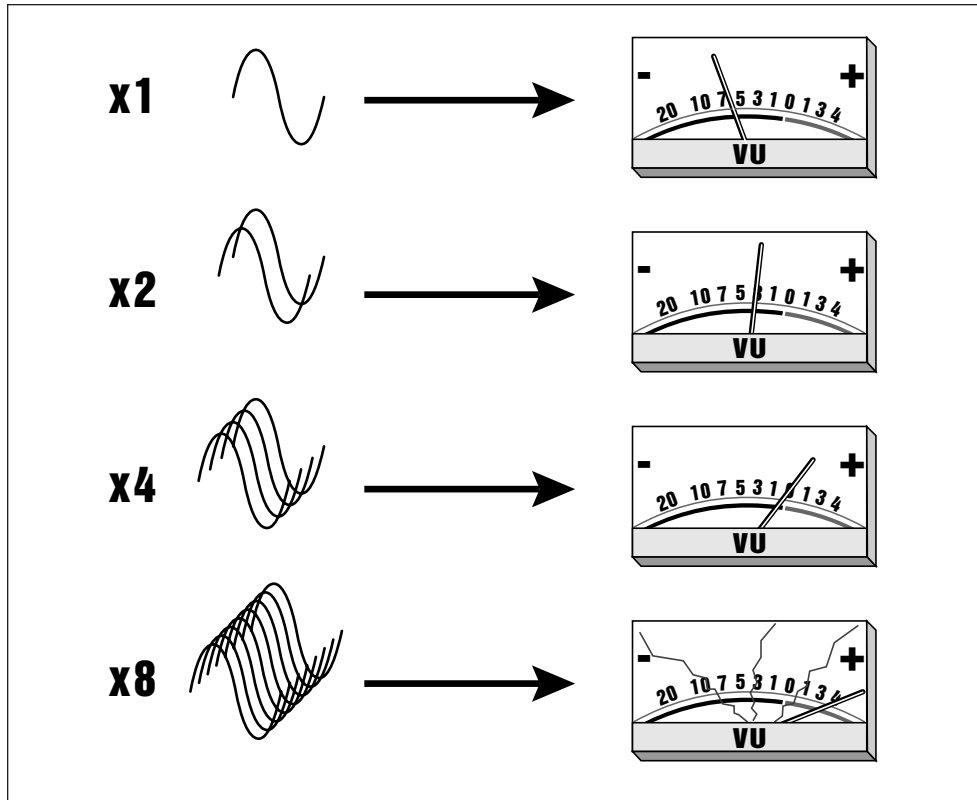

Each additional channel adds +3 dB to the output level of the E4K. Increasing the headroom allows you to play more channels without clipping.

4. If it is not already there, move the cursor to the Headroom field using the cursor keys or by pressing the F1 key.
5. Adjust the amount of remaining headroom using the data entry control, or inc/dec keys.
6. Press the **Exit** key twice to return to the Memory Statistics screen.

Master

▣ **Suggested Settings:**

Polyphonic Music:
Boost = 0
Headroom = 3

Single Sample Digital Transfer
Boost = +12
Headroom = 6 to 8

Master

★ **Caution:** *Output Boost is NOT saved to EEPROM.*

OUTPUT BOOST

Output Boost is similar to the headroom control and digitally raises the output level of the E4K by +12dB. This option provides the best signal-to-noise ratio when only one or two channels are being played at a time. However, playing back too many channels with Output Boost on will cause the output signal to clip. This control affects both the analog and digital outputs.

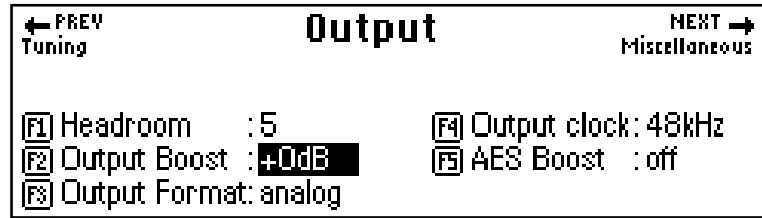

► To Change the Output Boost:

1. Press the **Master** key. The LED will illuminate and the Memory Statistics screen will appear.
2. Press the **Setup** function key (F3). A second row of soft keys will appear.
3. Press the **Output** function key (F2). The output menu will appear.
4. Move the cursor to the Output Boost using the cursor keys or by pressing the F2 key.
5. Set the output format to +0 dB or +12 dB using the data entry control, or inc/dec keys.
6. Press the **Exit** key twice to return to the Memory Statistics screen.

OUTPUT FORMAT

The E4K is equipped with a digital audio output for interfacing with other digital audio equipment. S/PDIF (consumer) and AES/EBU (professional) formats are both supported. The digital audio interface carries two channels of audio information which mirror the audio at the main outputs. The analog and digital outputs are always active. **This function optimizes the output of the E4K for whatever format is being used.** Set the Output Format to the format you are currently using either S/PDIF, AES/EBU or Analog.

► To Change the Output Format:

1. Press the **Master** key. The LED will illuminate and the Memory Statistics screen will appear.
2. Press the **Setup** function key (F3). A second row of soft keys will appear.
3. Press the **Output** function key (F2). The output menu will appear.
4. Move the cursor to the Output Format using the cursor keys or by pressing the F3 key.
5. Set the output format to S/PDIF, AES/EBU or Analog using the data entry control, or inc/dec keys.
6. Press the **Exit** key twice to return to the Memory Statistics screen.

Tip: Always use high-quality, low-capacitance, three-wire cable for the AES/EBU interface to insure data integrity.

Master

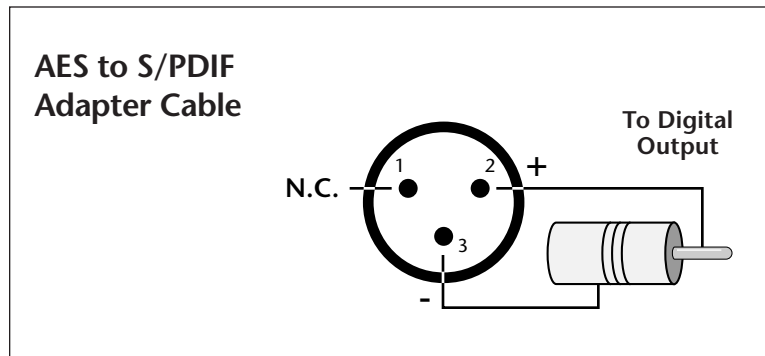

To connect the E4K's digital audio output to professional gear (AES/EBU), it may be necessary to use an adapter cable. This adapter should be constructed using video-grade cable.

Note: The head-room adjustment, the master volume control, AES Boost and the zone level all control the output level of the digital audio output. These controls can be adjusted when transferring digital audio to optimize the signal level.

OUTPUT CLOCK

This function is used to adjust the output sample rate of the E4K between 44.1 kHz or 48 kHz. This function sets the output rate of the entire machine (analog as well as digital outputs). If you wish to sample at 48 kHz, the output clock should also be set to 48 kHz or the output sample rate will be interpolated down to 44.1 kHz. Digital audio recorders will automatically record at the clock rate of the source, so set this control at 48 kHz to record into a DAT recorder.

► To Change the Output Clock Rate:

1. Press the **Master** key. The LED will illuminate and the Memory Statistics screen will appear.
2. Press the **Setup** function key (F3). A second row of soft keys will appear.
3. Press the **Output** function key (F2). The output menu will appear.
4. Move the cursor to the output clock using the cursor keys or by pressing the F4 key.
5. Set the output clock rate using the data entry control, or inc/dec keys.
6. Press the **Exit** key twice to return to the Memory Statistics screen.

AES BOOST

When this function is on, the gain of the digital output is boosted by +6 dB. This allows a better signal to noise ratio when using only a few of the E4K's output channels.

► To Change the Digital Output Level:

1. Press the **Master** key. The LED will illuminate and the Memory Statistics screen will appear.
2. Press the **Output** function key (F4). The Output menu will appear.
3. Move the cursor to AES Boost using the cursor keys or by pressing the F5 key.
4. Turn AES Boost On or Off using the data entry control, or inc/dec keys.
5. Press the **Exit** key to return to the Memory Statistics screen.

 **Caution:** *Playing back too many channels with AES Boost turned On may cause digital overload and clipping.*

MISCELLANEOUS

The Misc submenu, as the name suggests, contains master miscellaneous functions which don't fit in any other category.

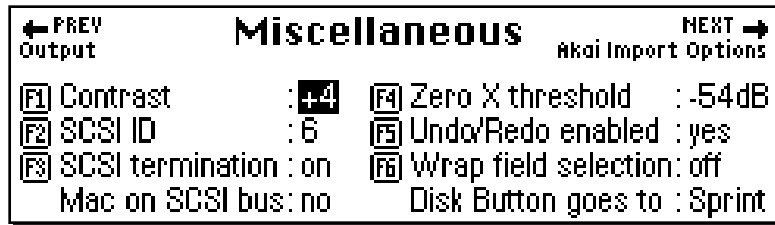

CONTRAST

This function allows you to change the viewing angle of the front panel LCD so that it may be easily read from either above or below. The angle is adjustable from +7 to -8. Adjust the contrast for the most comfortable viewing.

► To Change the Contrast:

1. Press the **Master** key. The LED will illuminate and the Memory Statistics screen will appear.
2. Press the **Setup** function key (F3). A second row of soft keys will appear.
3. Press the **Misc** function key (F3). The Miscellaneous menu will appear.
4. Move the cursor to the contrast amount using the cursor keys or by pressing the F1 key.
5. Adjust the contrast using the data entry control, or inc/dec keys.
6. Press the **Exit** key twice to return to the Memory Statistics screen.

Master

E4K SCSI ID

This utility allows you to change the SCSI ID number of the E4K itself, in the event that it conflicts with a device on the SCSI bus having the same ID number.

► To Change the ID Number of the E4K:

1. Press the **Master** key. The LED will illuminate and the Memory Statistics screen will appear.
2. Press the **Setup** function key (F3). A second row of soft keys will appear.
3. Press the **Misc** function key (F3). The Miscellaneous menu will appear.
4. Move the cursor to the SCSI ID number using the cursor keys or by pressing the F2 key.
5. Select the ID number using the data entry control, or inc/dec keys.
6. Press the **Exit** key twice to return to the Memory Statistics screen.

SCSI TERMINATION ON/OFF

This utility allows you to turn the internal SCSI termination On or Off under software control. Termination helps reduce line echoes or standing waves on the SCSI bus. Only the first and last device in a SCSI chain should be terminated. This function should normally be left On, since the E4K is usually connected at one end of the SCSI line.

► To Turn SCSI Termination On or Off:

1. Press the **Master** key. The LED will illuminate and the Memory Statistics screen will appear.
2. Press the **Setup** function key (F3). A second row of soft keys will appear.
3. Press the **Misc** function key (F3). The Miscellaneous menu will appear.
4. Move the cursor to the SCSI Termination On/Off using the cursor keys or by pressing the F3 key.
5. Turn SCSI Termination On or Off using the data entry control, or inc/dec keys.
6. Press the **Exit** key twice to return to the Memory Statistics screen.

MAC ON SCSI BUS

The E4K contains special software which allows multiple “Master” devices to peacefully coexist on the SCSI bus. A Macintosh or PC connected to the SCSI bus along with the E4K presents special requirements. Turn this function **On** if you have a personal computer connected to the SCSI bus.

► To Enable a Computer on the SCSI Bus:

1. Press the **Master** key. The LED will illuminate and the Memory Statistics screen will appear.
2. Press the **Setup** function key (F3). A second row of soft keys will appear.
3. Press the **Misc** function key (F3). The Miscellaneous menu will appear.
4. Move the cursor to “Mac on SCSI Bus”.
5. Turn “Mac on SCSI Bus” On or Off using the data entry control, or inc/dec keys.
6. Press the **Exit** key to return to the Memory Statistics screen.



ZERO CROSSING THRESHOLD

Background

The term zero crossing refers to the point at which the positive slope of a waveform passes through zero. In many sample editing applications, such as splicing and looping, it is useful to locate zero crossings in order to make glitch-free joins and loops. On some signals, however, a simple zero crossing may not be effective because the signal contains excessive noise or low-level, high-frequency harmonics. In these cases, every few samples may cross through zero. By setting a zero crossing threshold, we can ignore low-level zero crossings and wait for the signal to reach a certain level before choosing the next zero-crossing. Zero crossing threshold sets a level that a signal must exceed before the next zero crossing with a positive slope is selected. The selected zero crossing threshold is used in the Auto-Truncate function or whenever you manually select a zero crossing using the cursor keys.

The diagram below illustrates zero crossing in action. The small x marks the initial position. To move forward through the sound to the next zero crossing, press the right cursor button, as shown in the upper diagram. The E4K will find the first zero crossing on the positive slope after the signal has crossed the threshold.

To move backward through the sound to the next zero crossing, as shown in the lower diagram, press the left cursor button. The E4K will find the first zero crossing on the positive slope after the signal has crossed the designated threshold.

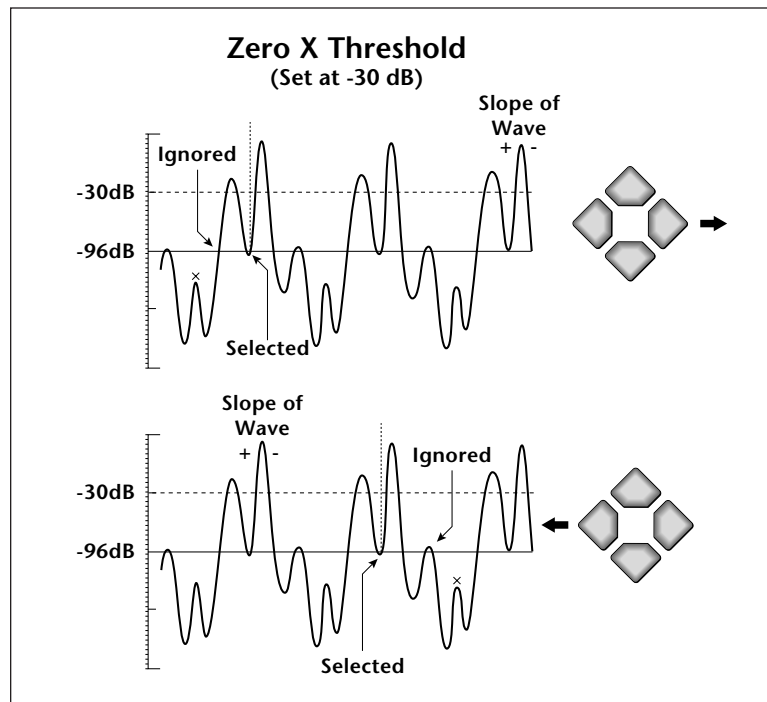

Use the data entry control or inc/dec buttons to select the zero crossing threshold. A setting of -96 dB will be the most sensitive; a setting of -30 dB will be the least sensitive. The selected zero crossing threshold is used in the auto-truncate function or whenever you manually select a zero crossing using the left/right cursor keys. If auto truncate does not seem to be working well, try adjusting the zero crossing threshold.

► **To Set the Zero-Crossing Threshold:**

1. Press the **Master** key. The LED will illuminate and the Memory Statistics screen will appear.
2. Press the **Setup** function key (F3). A second row of soft keys will appear.
3. Press the **Misc** function key (F3). The miscellaneous menu will appear.
4. Move the cursor to Zero-X Threshold using the cursor keys or the F4 key.
5. Set the desired zero-crossing threshold using the data entry control, or inc/dec keys.
6. Press the **Exit** key twice to return to the Memory Statistics screen.

UNDO/REDO ENABLE

Background - Undo and Redo

During many Sample Editing operations, the E4K will automatically back up the sample being processed and store this backup on the system drive. If you do not like the results of the processing, you can call up the Undo function, and restore the original sample from the system drive. (Ah, if only life itself were so simple.) Best of all, the processed sample will now move onto the system drive. Thus, if you decide you liked the processed version better after all, you can actually undo the undo. (Redo.)

The display will inform you if there is not enough memory to back up a sample onto the system drive. You then have two choices: either free up some additional memory by erasing banks on the system drive, or disable the backup process using this function. Of course, if backup is disabled, you will not be able to undo an operation.

► **To Enable Undo/Redo:**

1. Press the **Master** key. The LED will illuminate and the Memory Statistics screen will appear.
2. Press the **Setup** function key (F3). A second row of soft keys will appear.
3. Press the **Misc** function key (F3). The Miscellaneous menu will appear.

4. Move the cursor to Undo/Redo Enable using the cursor keys or the F5 key.
5. Enable or disable Undo/Redo using the data entry control, or inc/dec keys.
6. Press the **Exit** key twice to return to the Memory Statistics screen.

WRAP FIELD SELECTION

When wrap field selection is On, moving the cursor past the last selection in a window makes it jump back up to the first selection. With wrap field selection Off, the cursor will NOT move past the last selection in a window by pressing the right or down cursor keys. You have to use the up or left cursor key to go back.

► To Turn Wrap Field Selection On or Off:

1. Press the **Master** key. The LED will illuminate and the Memory Statistics screen will appear.
2. Press the **Setup** function key (F3). A second row of soft keys will appear.
3. Press the **Misc** function key (F3). The miscellaneous menu will appear.
4. Move the cursor to Wrap Field Selection using the cursor keys.
5. Turn Wrap Field Selection On or Off using the data entry control, or inc/dec keys.
6. Press the **Exit** key twice to return to the Memory Statistics screen.

DISK BUTTON GOES TO:

This preference allows you to set the function of the front panel disk button. The disk button can be set to jump directly into SoundSprint mode or it can call up the last Disk Browser screen you accessed.

► To Assign the Disk Button:

1. Press the **Master** key. The LED will illuminate and the Memory Statistics screen will appear.
2. Press the **Setup** function key (F3). A second row of soft keys will appear.
3. Press the **Misc** function key (F3). The miscellaneous menu will appear.
4. Move the cursor to “Disk Button goes to” using the cursor keys.
5. Select either “Sprint” or “Last” using the data entry control, or inc/dec keys.
6. Press the **Exit** key twice to return to the Memory Statistics screen.

A black rectangular button with the word "Master" written vertically in white text.

IMPORT OPTIONS

The E4K has the ability to read Akai™ S1000 and S1100 and Roland™ S-760 disks. Samples, partials, patches, performances and volumes are automatically mapped into the appropriate Emulator parameters. There are a few differences between these samplers and the E4K. For this reason, some program parameters may be ignored during the conversion process. In most cases however, the converted programs and samples should sound and behave very much like the originals.



In the Roland disk structure, objects are allowed to exist outside of a containing parent object. For example, in the E4K, Samples are contained by Presets, which are contained by Banks and so on. To deal with this problem, a special browser item is added at the end of the Folder, Bank, Preset and Sample lists. These special objects are labeled “All” (as in All Patches) and contain all items of a particular type on the disk. This allows all objects on the disk to be browsed, including stray samples, presets or banks.

The import options are as follows:

■ **Note:** When browsing Roland disks, only Samples referenced by the selected Preset will be displayed, unlike the Emulator where all Samples contained in the Bank are displayed.

- **Combine L/R into Stereo:** When this option is set to On, the E4K will look within an Akai or Roland key group for left/right samples that can be combined into a single stereo sample. If the first ten characters of the 12 character sample name match, and the last two characters are “-L” and “-R”, as in Akai stereo samples, they will be combined into an E4K stereo sample. Roland stereo samples will be combined into Emulator stereo samples if this function is turned On. Program parameters for the new stereo sample are taken from the left sample. The right side parameters are ignored. When this function is Off, stereo samples are not created and each sample is placed in a separate voice.

- **Adjust Fractional Loops:** Sample looping is implemented differently on the E4K and the Akai. Because of this difference, certain loops may “tick” slightly or appear out of tune after being transferred from the Akai. This function will automatically repair any incorrect sample loops after being transferred. Be advised that the transfer may take slightly longer (up to 15% more time) with Adjust Fractional Loops turned On.
- **Foreign Sampler SCSI ID:** If you have another brand of sampler connected to the SCSI bus, the E4K needs to know its SCSI ID in order to avoid SCSI conflicts. The Foreign SCSI ID should be entered *before* connecting the sampler onto the SCSI chain. You do NOT have to set this parameter for Akai or Roland formatted storage devices as these will be recognized automatically.

✦ Complete Roland Volumes cannot be loaded because they may contain multiple MIDIMaps. Load “All Patches” instead.

► **To Set the Import Options:**

1. Press the **Master** key. The LED will illuminate and the Memory Statistics screen will appear.
2. Press the **Setup** function key (F3). A second row of soft keys will appear.
3. Press the **Import** function key (F4). The Import Options menu will appear.
4. Move the cursor to the desired option using the cursor keys and change the parameter using the data entry control or the inc/dec keys.
5. Press the **Exit** key twice to return to the Memory Statistics screen.

LIMITATIONS

- **Roland** - Only supports 512 byte/sector devices.
 - Only tuning, keymap, velocity switching and positional crossfade are translated. No envelopes, modulation filter settings cords, etc. in this release.
 - Only one forward loop will be imported.
- **Akai** - Only two layers are translated.

™ Akai S1000 and Akai S1100 are registered trademarks of Akai Digital.
™ Roland S-760 is a trademark of the Roland Corporation.



MEMORY CONFIGURATION

Presets and Sequences are stored in an area of RAM unrelated to the amount of sample RAM you have in your Emulator. This RAM size is fixed at 568 Kbytes and is shared by sequences and presets. The Memory Configuration control allows you to adjust the balance of RAM allocated to the sequencer and the presets.

If a sequence is too large to be loaded, you can increase sequence memory size. If you run out of preset space, simply increase the amount of RAM allocated to presets.

► To Set the Memory Configuration:

1. Press the **Master** key. The LED will illuminate and the Memory Statistics screen will appear.
2. Press the **Setup** function key (F3). A second row of soft keys will appear.
3. Press the **Memory** function key (F5). The Memory Configuration screen will appear.
4. Adjust the Preset and Sequence memory size using the data entry control or the inc/dec keys.
5. Press the **Save** key to save the changes or **Cancel** to return to the Memory Statistics screen.

Master Effects A

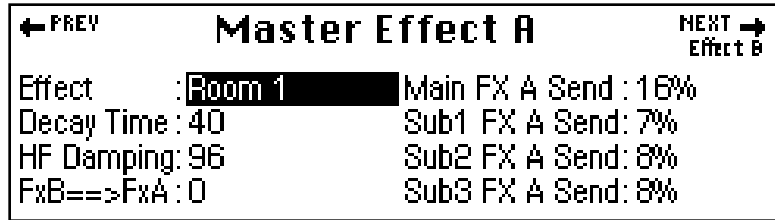

The Master Effects settings are used when the effect programmed in the Preset Edit, Global menu is set to “Master Effect”. This system allows the effects to be assigned per preset or globally for all presets. There are two effects processors, “Effect A” and “Effect B”. “A” type effects consist of various reverbs and delay effects.

Master Effects A can be accessed by pressing the FX soft key (F4) from the Master menu. Another row of soft keys will appear. Press the FxA soft key (F1) to access the Effects A menu. After the master effects have been selected, pressing the front panel Controls key will jump you to the master effects.



MASTER EFFECTS

You might want the effects to be programmed on a global basis in **Omni and Poly modes**. You could choose your favorite reverb, for example, and have it applied to any preset you select

► To Program the Effects Globally for all Presets:

1. Press the Preset Edit key. The LED will illuminate and the Preset Edit screen will appear.

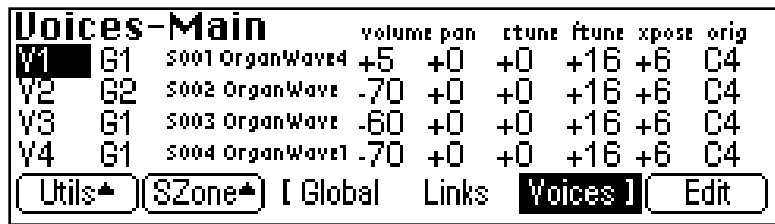

Tip: The Controls key can be used to quickly access the Effects menu (either Master FX or Preset FX) that you used last. Press the Controls key to Set the key to the selected menu. Press the Controls key repeatedly to rotate around through the menus.

- If you are in a screen where the “Global, Links, Voices” soft-keys are not visible, press the **Exit** key once.
- 2. Press the **Global** function key (F3). The Global menu will appear.
- 3. Press the **Next** page key. The Preset Effect A menu will appear.
- 4. Set the Effect field to **Master Effect**, which will cause the Master effect settings to be used.
- 5. Press the **Next** page key again to go to the Preset Effect B menu. Set the Effect to the Master Effect setting if you wish the Master settings to be used.
- 6. Change each preset in the bank to the Master Effect setting if you want the Master Effect setting used on all presets.
- 7. Save the bank.

USE MASTER EFFECTS SETTINGS IN MULTI MODE

In Multi Mode the two effects processors can be either controlled from the Master Effects settings or they can follow the effects settings of the preset on a special MIDI channel. Because up to 16 presets can play at once in multi mode, the effects cannot be programmed at the preset level. There are only two effect processors!

► To Program the Effects Globally for all Presets:

1. Press the **Master** key. The LED will illuminate and the Memory Statistics screen will appear.
2. Press the **MIDI** function key (F6). A second row of MIDI options will appear.
3. Press the **Mode** function key (F1). The MIDI mode menu will appear.
4. Move the cursor to the Effect Control field using the cursor keys or by pressing the F4 key.
5. Set the Multimode Effect Control Channel to **Off** using the data entry control or inc/dec keys.
6. Press the **Exit** key three times to save the settings and return to the main screen.

EFFECT

This function selects the type of effect used. The following effects are currently available:

► A EFFECT TYPES

Room 1-3	Bright Plate
Hall 1 & 2	BBall Court
Plate	Gymnasium
Delay	Cavern
Panning Delay	Concert 9
Multitap 1	Concert 10 Pan
Multitap Pan	Reverse Gate
3 Tap	Gate 2
3 Tap Pan	Gate Pan
Soft Room	Concert 11
Warm Room	Medium Concert
Perfect Room	Large Concert
Tiled Room	Large Concert Pan
Hard Plate	Canyon
Warm Hall	DelayVerb 1-3
Spacious Hall	DelayVerb 4-5 Pan
Bright Hall	DelayVerb 6-9
Bright Hall Pan	



**Please refer to Chapter 4,
FX & Sequencer, for detailed
information concerning the Effects**

Master Effects B

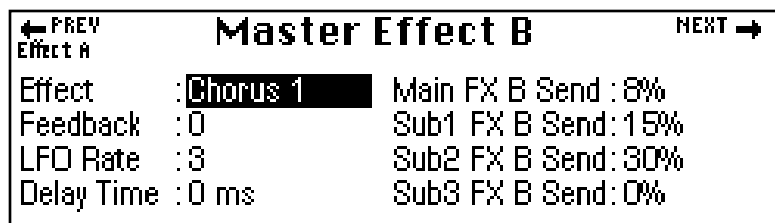

The Master Effects settings are used when the effect programmed in the Preset Edit, Global menu is set to “Master Effect”. This system allows the effects to be assigned per preset or globally for all presets. There are two effects processors “Effect A” and Effect B”. “B” type effects consist mainly of chorus, flange and digital delay effects.

Master Effects A can be accessed by pressing the FX soft key (F4) from the Master menu. Another row of soft keys will appear. Press the FxB soft key (F2) to access the Effects A menu. Once the Master Effects have been selected, press the front panel Controls key to jump you to the Master Effects.

EFFECT

This function selects the type of effect used. The following effects are currently available:

► B EFFECT TYPES

Chorus 1-5	Delay Stereo 1 & 2
Doubling	Panning Delay
Slapback	Delay Chorus
Flange 1-7	Pan Delay Chorus 1 & 2
Big Chorus	Dual Tap 1/3
Symphonic	Dual Tap 1/4
Ensemble	Vibrato
Delay	

Tip: The Controls key can be used to quickly access the Effects menu (either Master FX or Preset FX) that you used last. Press the Controls key to “Set” the key to the selected menu. Press the Controls key repeatedly to rotate around through the menus.

Master

Sequence Manage

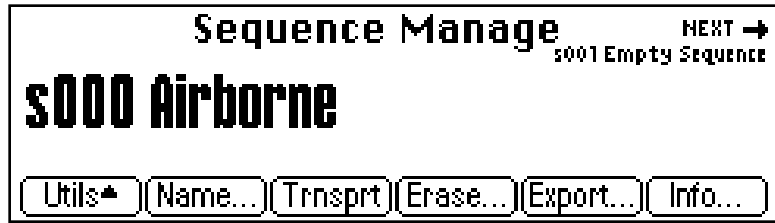

This menu contains the sequencer options. The sequencer was designed to be a “scratchpad” to capture your musical ideas. Sequences can then be exported as Standard MIDI Files to a full-featured computer sequencer for editing. Edited sequences can later be re-loaded back into the E4K. Up to 10 sequences can be recorded and are saved when you save the bank. The note capacity depends entirely on how much memory you allocate to sequences, and ranges from approximately 350 to well over 97,000 notes. The 16-track sequencer can record program changes, controller changes and SysEx data as well as note and velocity information.

Please refer to Chapter 4, FX & Sequencer for detailed information on the sequencer.

The Sequencer Manage menu contains six sub menus:

- **Utilities** - Contains Copy, Info, Setup functions, Time Display, and Memory Status.
- **Name** - Allows you to name your sequences.
- **Transport** - The front panel transport controls can control either the internal sequencer, an external sequencer or another device via MIDI Machine Control. This screen also controls the status of each track. The four track states are: Record, Play, Mute and Solo.
- **Erase** - Allows you to erase the current sequence.
- **Export** - Allows you to export the currently selected sequence as a Standard MIDI File.
- **Jukebox** - Allows you to play up to ten sequences in series.

Tip: The Memory Configuration function, located in the Master, Setup menu, allows you to set the amount of sequencer memory.

► **To Enter the Sequence Manage Menu:**

Press the **Sequencer** key. The sequencer menu shown on the previous page will appear.

► **To Change the Current Sequence:**

From the **Sequence** menu, use the data entry control or inc/dec keys to select one of the ten sequence locations.

SEQUENCER TRANSPORT CONTROLS

These controls should look familiar to you. They work exactly like the controls on a cassette deck or any other tape recorder.

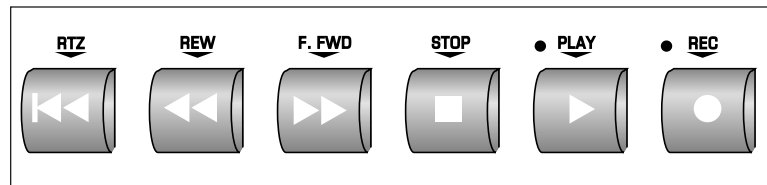

RETURN TO ZERO ... Resets the sequence to the beginning.

REWIND Moves backward through the sequence.

FAST FORWARD Moves forward through the sequence.

STOP Immediately stops the sequence.

PLAY Starts the sequence playing from its current position.

RECORD Initiates recording (*when pressed in combination with Play*).

► **To Record a Sequence:**

Press the front panel **Record** button, (the red LED will be flashing) then press the **Play** button.

► **To Play Back a Sequence:**

Press the front panel **Play** button. To start the sequence from the beginning, press the **RTZ** (Return-To-Zero) button first.

MIDI Globals

Type	Total	Used	
Preset	504k	0k	0%
Sample	8mb	6.21mb	77%
Mode	Cntrls1	Cntrls2	Prefs1 Prefs2

The MIDI Global menu allows you to change the MIDI parameters which affect the overall MIDI operation. The MIDI Globals menu is accessed by pressing the MIDI key from the Memory Statistics screen.

The MIDI Globals menu contains three sub menus:

- **Mode** - Selects MIDI basic channel, mode and local control status.
- **Control 1 & 2** - Sets the controller and MIDI controllers sent and received by the E4K.
- **Preferences 1 & 2** - Miscellaneous MIDI preference functions such as velocity curve, controller sensitivities, etc., which are stored in EEPROM.

Master

MIDI Mode

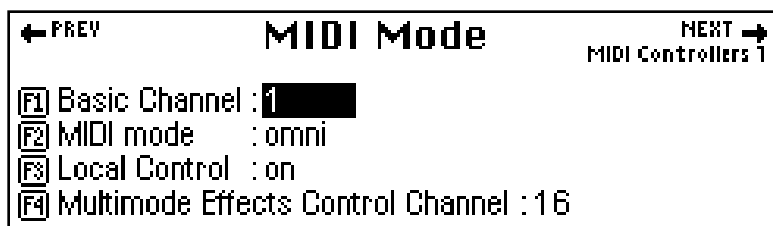

Master

Tip: *The Basic Channel can also be set from the Multimode screen. Simply select the desired channel and press the **SetKybd** function key (F2).*

BASIC CHANNEL

The Basic MIDI Channel is the channel E4K transmits through the MIDI Out port and the channel that will be recorded into the sequencer. It is also used in the special case of Poly mode. In Poly Mode, the E4K only receives MIDI data on the selected basic channel and ignores data on all other channels.

► To Set the Basic MIDI Channel

1. Press the **Master** key. The LED will illuminate and the Memory Statistics screen will appear.
2. Press the **MIDI** function key (F6). The MIDI Globals sub menu will appear.
3. Press the **Mode** function key (F1). The MIDI Mode menu will appear.
4. Move the cursor to Basic Channel using the cursor keys or the F1 key.
5. Set the basic MIDI channel using the data entry control, or inc/dec keys.
6. Press the **Exit** key twice to return to the Memory Statistics screen.

MIDI MODE

The E4K can be used in any of three MIDI modes:

- **Omni Mode** - Receives MIDI data on any and all channels at once and plays the current preset.
- **Poly Mode** - Receives MIDI data only on the basic channel and plays the current preset.
- **Multi Mode** - Receives MIDI data on any and all channels at once and plays the preset assigned to each MIDI channel as assigned in the main Multimode screen.

► To Change the MIDI Mode:

1. Press the **Master** key. The LED will illuminate and the Memory Statistics screen will appear.
2. Press the **MIDI** function key (F6). The MIDI Globals sub menu will appear.
3. Press the **Mode** function key (F1). The MIDI Mode menu will appear.
4. Move the cursor to MIDI Mode using the cursor keys or the F2 key.
5. Change the MIDI mode using the data entry control, or inc/dec keys.
6. Press the **Exit** key twice to return to the Memory Statistics screen.

A black rectangular button with the word "Master" written vertically in white text.

LOCAL CONTROL

When Local Control is turned Off, the keyboard and controllers (wheels, sliders, pedals, etc.) are disconnected from the sound generating section of the E4K, but are still transmitted over MIDI. Local Control is often turned Off when recording into a MIDI sequencer (set sequencer to Echo Thru).

► To Turn Local Control On or Off:

1. Press the **Master** key. The LED will illuminate and the Memory Statistics screen will appear.
2. Press the **MIDI** function key (F6). The MIDI Globals sub menu will appear.
3. Press the **Mode** function key (F1). The MIDI Mode menu will appear.
4. Move the cursor to Local Control using the cursor keys or the F3 key.
5. Turn Local Control On or Off using the data entry control, or inc/dec keys.
6. Press the **Exit** key twice to return to the Memory Statistics screen.

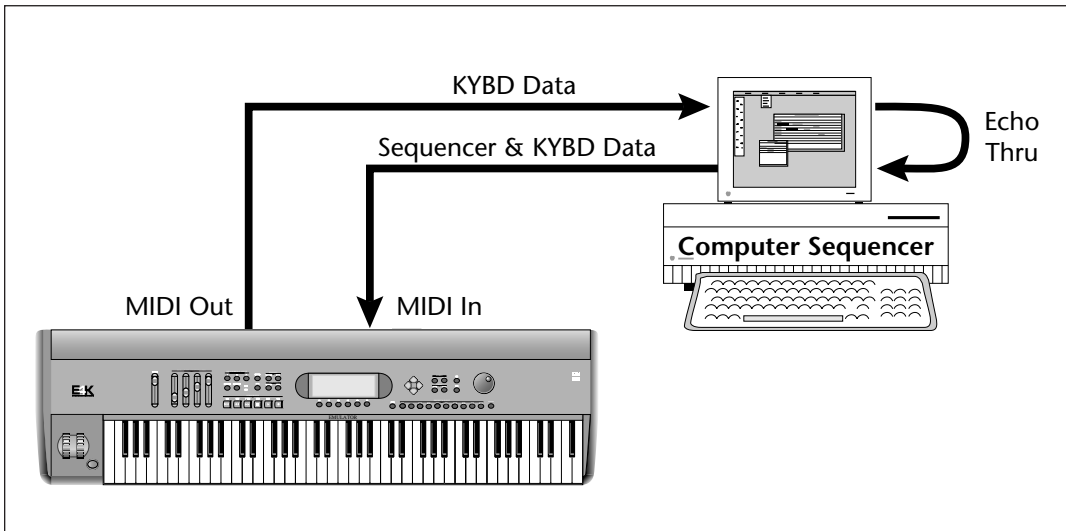

Turning Local Control Off allows you to use the Echo Thru feature on your sequencer while sequencing. If Local Control were turned on in the example above, notes played on the keyboard would be echoed back by the sequencer and sound twice.

EFFECTS CONTROL

The E4K is very flexible when it comes to controlling the effects processors. The effects can be controlled in three different ways to suit your personal preference and to adapt to different situations.

1. Programmed as part of the preset when playing single presets (*Omni or Poly Modes*).
2. Programmed from the Master Effects Section when playing either single presets (*preset Effect Type set to "Master"*) or when in Multi Mode.
3. Programmed from the designated control preset when in Multi Mode. The **Effects Control parameter sets the MIDI channel whose preset will control the effects processors.**

In Multi Mode the two effects processors can be either controlled from the Master Effects settings or they can follow the effects settings of the preset on a specific MIDI channel. This feature allows you to change effects during a sequence and to control the effects amounts and settings from a sequencer using continuous controller messages.

► To Set the Multimode Effects Control Channel:

1. Press the **Master** key. The LED will illuminate and the Memory Statistics screen will appear.
2. Press the **MIDI** function key (F6). The MIDI Globals sub menu will appear.
3. Press the **Mode** function key (F1). The MIDI Mode menu will appear.
4. Move the cursor to Multimode Effects Control Channel using the cursor keys or the F4 key.
5. Set Multimode Effects Control Channel to the desired MIDI channel or Off using the data entry control, or inc/dec keys. If Effects control is turned Off, the Master effects settings will be used in Multi Mode.
6. Press the **Exit** key twice to return to the Memory Statistics screen.

Master

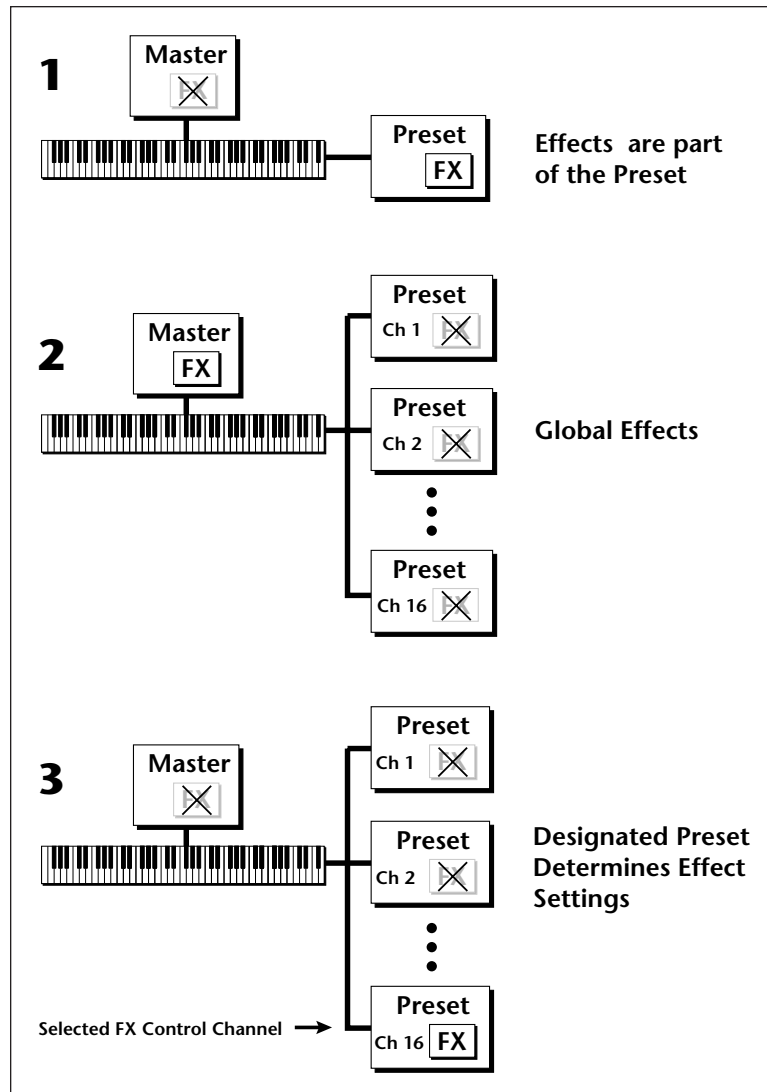

Tip: You can create special presets without samples to be used as "Effects Presets". By assigning these effects presets to the Multimode Effects Control Channel, you use Program Change commands to switch between effects during a sequence.

Effects can be controlled from three different locations.

- 1) The effects can be programmed as part of the preset in Omni or Poly modes.
- 2) The effects can be globally programmed in the Master menu in Omni, Poly or Multi modes.
- 3) The effects can follow the effects settings of the preset on a specific MIDI channel in multimode. This allows effects to be changed using MIDI program change commands.

MULTI MODE - MIDI MIX

When Multimode is selected as the MIDI mode, the main display of the E4K transforms from a single preset selection screen into a MIDI Mix screen. The MIDI Mix screen allows you to display and adjust the preset, volume, pan settings and output assignments for 16 MIDI channels. This is a useful feature to fine tune multi-timbral sequences. This screen also allows you to override the output channel programmed in the voice. Any volume, pan and preset changes made over MIDI will be reflected in this display. (Volume = MIDI continuous controller channel #7, Pan = MIDI continuous controller channel #10)

Multimode		volume	pan	submix	pitch	mod
Ch 1	P000 Untitled Preset	127	+0	voice	0	0
Ch 2	Disabled	127	+0	voice	0	0
Ch 3	Disabled	127	+0	voice	0	0
Ch 4	Disabled	127	+0	voice	0	0

+ (SetKybd) (View) (Load...) (Save...) (Omni)



► To Change the MIDI Mix

1. Set the MIDI mode to **Multi** as described on the previous page or simply select Multi after pressing the key on the main preset screen.
2. Select a channel using the Up/Down cursor keys, then pressing **SetKybd** (F2) sets the MIDI channel on which the E4K keyboard will transmit.
3. Press the right arrow key to display (or change) the values of MIDI controllers A-H. These values can also be edited just as if you were moving the actual controller.

Tip: Pan *ADDS* to the pan setting made in the voice and is not an absolute pan setting.

	midia	midib	midic	midid	midie	midif	midig	midih
Ch 1	0	0	0	0	0	0	0	0
Ch 2	0	0	0	0	0	0	0	0
Ch 3	0	0	0	0	0	0	0	0
Ch 4	0	0	0	0	0	0	0	0

+ (SetKybd) (View) (Load...) (Save...) (Omni)

4. Press the **View** key to toggle the MIDI Mix back to graphic display mode.

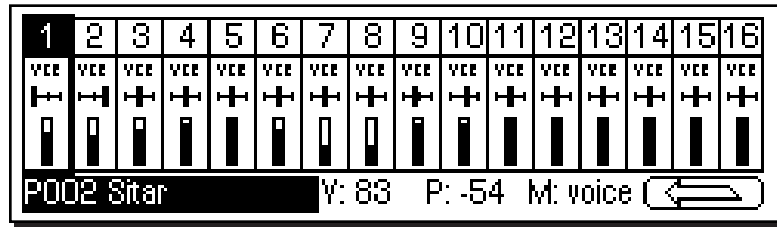

5. Select the desired MIDI channel using the up/down cursor keys.
6. Select preset, volume, pan or the output channel using the left/right cursor keys. Change the parameter values using the data entry control, the inc/dec keys, or the numeric keypad.
7. Set MIDI mode to Poly or Omni to change the main screen back to a single preset display format.
8. Press the  key and then the **View** key to change the display to list view mode. The list view screen displays the values of the pitch and modulation wheels. The amounts of the wheels can also be adjusted, just as if you were moving the wheels to the left of the keyboard.

❑ **Note:** To Change Program Banks via MIDI SysEx, send:

Bn 00 00 20 ll Cn pp

n = MIDI chan. number (0-F)

ll = Bank number (00-06)

pp = Preset in the new bank (00-7F)

This allows you to access presets higher than 128 via MIDI.

On your sequencer: Use Continuous Controller #32

MIDI Controllers

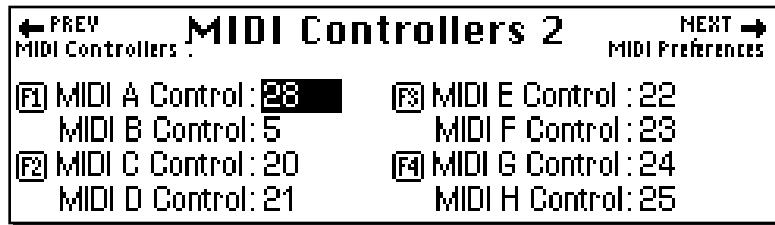
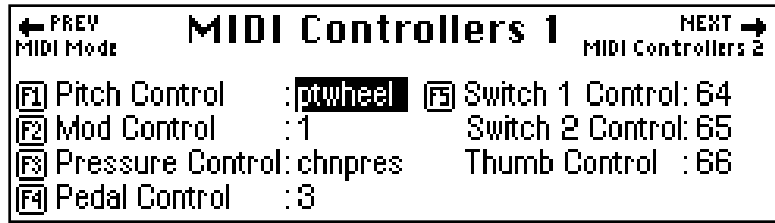

This menu allows you to assign up to 15 MIDI continuous controllers which will be received by the E4K. The controllers on page one as well as MIDI A-H on page two will also be transmitted on the controller channel shown. The MIDI controllers you assign will be used by all presets. (Note: the names attached to the controllers such as “Pitch Control” and “Mod Control” are arbitrary. They can be assigned to any destination in the Preset Edit menu.)

► To Setup the MIDI Controllers

1. Press the **Master** key. The LED will illuminate and the Memory Statistics screen will appear.
2. Press the **MIDI** function key (F6). The MIDI Globals sub menu will appear.
3. Press the **Controls 1** or **2** function key (F2 or F3). The MIDI Controllers menus shown above will appear.
4. Move the cursor to desired controller name using the cursor keys or the indicated “F” keys.
5. Select the MIDI controller numbers using the data entry control, or inc/dec keys.
6. Press the **Exit** key twice to return to the Memory Statistics screen.

⚠ Caution: In the E4K MIDI continuous controller number 7 is permanently assigned to volume and controller 10 is assigned to pan. Using these numbers for other functions could have unpredictable results.

💡 Tip: Assigning the MIDI Controller is only half of the connection. The controller's destination must be assigned in the Preset Edit, Cords submodule.

ABOUT MIDI CONTROLLERS

You probably already know that there are 16 MIDI channels that can be used. Each of the 16 MIDI channels uses basically 3 types of messages; *note on/off*, *program changes*, and *continuous controller* messages.

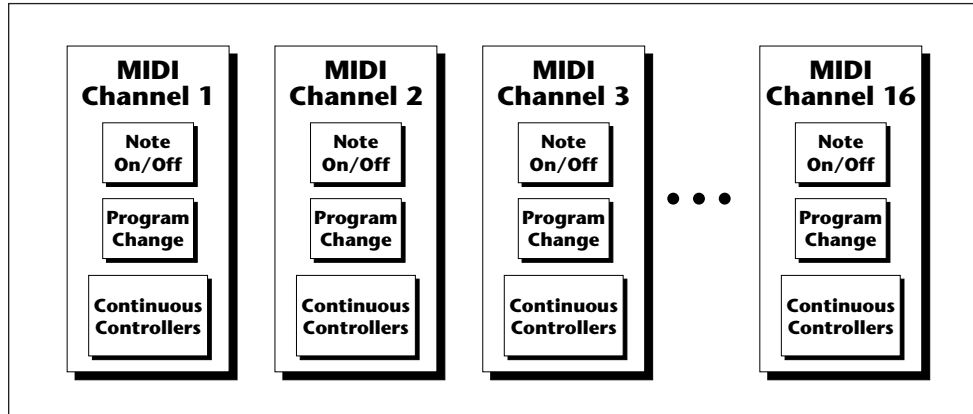

Tip: A few of the standardized MIDI Controller numbers are listed below.

- 1 - Modulation Wheel
- 2 - Breath Controller
- 3 - Foot Pedal
- 4 - Foot Pedal
- 5 - Portamento Time
- 6 - Data Entry
- 7 - Volume
- 8 - Balance
- 9 - Undefined
- 10 - Pan
- 11 - Expression
- 64 - Sustain (on/off)
- 65 - Portamento (on/off)
- 66 - Sostenuto (on/off)
- 67 - Soft Pedal (on/off)
- 69 - Hold Pedal (on/off)

The E4K, in addition to describing which note was played, also sends *realtime control* information. Realtime control sources include such things as the pitch wheel, modulation wheel, control pedal, aftertouch, the two footswitches and the four realtime control sliders. All these controls are designed to give you more expression in your music.

Realtime controller information is sent on separate channels called *continuous controller channels*. There is a set of 32 continuous controller channels for each of the 16 MIDI channels. Some of the controller channels, such as Mod Wheel, volume, and pan have been standardized. For example, volume is usually sent on continuous controller channel #7.

The E4K allows you to route any continuous controller to any realtime modulation destination internally. The internal connections for a particular preset are completed in the Preset Edit menu.

The realtime controllers are also transmitted out the MIDI port on the controller number you specify. Simply set the controller number of the E4K slider (A-D) so that it matches the number on the receiving device. (Make sure the MIDI channels are the same too.) That's it!

MIDI Preferences

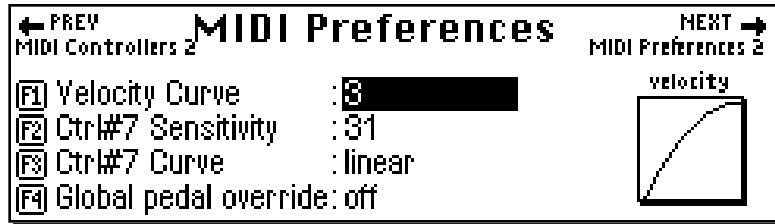

This submenu contains several additional global MIDI functions.

VELOCITY CURVE

Incoming velocity values can be scaled by one of fourteen curves to better adapt to your playing style or MIDI controller. Selecting “linear” leaves the velocity data unaltered. The shape of the selected curve is displayed in the window. Select the curve that works best for you.

► To Set the Velocity Curve:

1. Press the **Master** key. The LED will illuminate and the Memory Statistics screen will appear.
2. Press the **MIDI** function key (F6). The MIDI Globals submenu will appear.
3. Press the **Prefs 1** function key (F4). The MIDI Preferences 1 submenu will appear.
4. Move the cursor to Velocity Curve using the cursor keys or the F1 key.
5. Set the Velocity Curve using the data entry control, or inc/dec keys.
6. Press the **Exit** key twice to return to the Memory Statistics screen.

Master

CONTROLLER #7 SENSITIVITY

This function allows you to modify the E4K's response curve for MIDI continuous controller #7 (Volume). This allows you to match the E4K's response to other manufacturer's equipment. Low numbers compress the volume control range, raising the volume level at lower controller #7 values. The action of this control is displayed in the curve display on the right side of the screen.

► To Adjust MIDI Controller #7 Sensitivity:

1. Press the **Master** key. The LED will illuminate and the Memory Statistics screen will appear.
2. Press the **MIDI** function key (F6). The MIDI Globals sub menu will appear.
3. Press the **Prefs 1** function key (F4). The MIDI Preferences 1 submenu will appear.
4. Move the cursor to Ctrl #7 Sensitivity or use the F2 key.
5. While sending controller #7 messages adjust the sensitivity using the data entry control, or inc/dec keys.
6. Press the **Exit** key twice to return to the Memory Statistics screen.

CONTROLLER #7 CURVE

This is another adjustment to help match the E4K to other manufacturer's equipment. Three curves are provided: Linear, Squared or Logarithmic. The action of this control is displayed in the curve display on the right side of the screen.

► To Adjust MIDI Controller #7 Sensitivity:

1. Press the **Master** key. The LED will illuminate and the Memory Statistics screen will appear.
2. Press the **MIDI** function key (F6). The MIDI Globals sub menu will appear.
3. Press the **Prefs 1** function key (F4). The MIDI Preferences 1 submenu will appear.
4. Move the cursor to Ctrl #7 Curve or use the F3 key.
5. While sending controller #7 messages adjust the curve using the data entry control, or inc/dec keys.
6. Press the **Exit** key twice to return to the Memory Statistics screen.

GLOBAL PEDAL OVERRIDE

This feature overrides any footpedal assignments made in the voice and forces the footpedal to become a master volume pedal which emulates the front panel volume control.

► To Turn Global Pedal Override On/Off

1. Press the **Master** key. The LED will illuminate and the Memory Statistics screen will appear.
2. Press the **MIDI** function key (F6). The MIDI Globals sub menu will appear.
3. Press the **Prefs 1** function key (F4). The MIDI Preferences 1 submenu will appear.
4. Move the cursor to Global Pedal Override using the **Cursor Keys** or the F4 key.
5. Turn Global Pedal Override On or Off using the data entry control, or inc/dec keys.
6. Press the **Exit** key twice to return to the Memory Statistics screen.

Master

RECEIVE PROGRAM CHANGE ON/OFF

This feature allows the E4K to either utilize or ignore incoming MIDI program change commands.

► To Turn Receive Program Change On/Off

1. Press the **Master** key. The LED will illuminate and the Memory Statistics screen will appear.
2. Press the **MIDI** function key (F6). The MIDI Globals sub menu will appear.
3. Press the **Prefs 2** function key (F5). The MIDI Preferences 2 submenu will appear.
4. Move the cursor to Receive Program Change On/Off using the **Cursor Keys** or the F2 key.
5. Turn Receive Program Change On or Off using the data entry control, or inc/dec keys.
6. Press the **Exit** key twice to return to the Memory Statistics screen.

▣ **Note:** To Change Program Banks via MIDI SysEx, send:

Bn 00 00 20 II Cn pp

n = MIDI chan. number (0-F)

II = Bank number (00-06)

pp = Preset in the new bank (00-7F)

This allows you to access presets higher than 128 via MIDI.

On your sequencer: Use Continuous Controller #32

❑ **Note:** *Send Program Change does not work in Multi mode.*

Master

⚡ **Tip:** *Make sure to send the two program changes as separate events. Some sequencers send only one program change if the two are located on the same beat.*

SEND PROGRAM CHANGE ON/OFF

When presets are selected from the front panel, MIDI program change commands can either be sent or not sent from the MIDI Out port.

► To Send Program Change:

1. Press the **Master** key. The LED will illuminate and the Memory Statistics screen will appear.
2. Press the **MIDI** function key (F6). The MIDI Globals sub menu will appear.
3. Press the **Prefs 2** function key (F5). The MIDI Preferences 2 submenu will appear.
4. Move the cursor to Send Program Change On/Off using the **Cursor Keys** or the F2 key.
5. Turn Send Program Change On or Off using the data entry control, or inc/dec keys.
6. Press the **Exit** key twice to return to the Memory Statistics screen.

MAGIC LOAD PRESET

This feature allows a MIDI command to load banks from the hard disk. The “Magic Preset” is a preset number which signals the E4K that the next preset change command is the bank number to be loaded. Therefore, to load a hard disk bank over MIDI, two program change commands must be sent, the Magic Preset and the bank number. As an example, if the Magic Preset is set at “P85”, and the E4K receives a preset change command of 85 followed by a preset change command of 11, the E4K will load bank 11 from the hard disk. The E4K will load from the current drive and current folder. The Magic Preset is user definable and can be turned off or set to any preset number from 0 to 127.

► To Set the Magic Load Preset

1. Press the **Master** key. The LED will illuminate and the Memory Statistics screen will appear.
2. Press the **MIDI** function key (F6). The MIDI Globals sub menu will appear.
3. Press the **Prefs 2** function key (F5). The MIDI Preferences 2 submenu will appear.

4. Move the cursor to Magic Load Preset using the cursor keys or the F3 key.
5. Set the Magic Preset using the data entry control, or inc/dec keys.
6. Press the **Exit** key twice to return to the Memory Statistics screen.



Effects & Sequencer

Dual Effects Processors	127
The Effects Sends	128
Effect B into Effect A	130
Three Way Effects Control	131
<i>Effects as Part of the Preset</i>	132
<i>Master Effects Programming</i>	133
<i>The Effects Channel in Multimode</i>	135
Effect Descriptions	136
Sequencer Manager	141
<i>Utilities</i>	143
<i>Copy</i>	143
<i>Info</i>	144
<i>Setup</i>	145
<i>Time</i>	146
<i>Memory</i>	147
<i>Name</i>	148
<i>Transport</i>	148
<i>To Record a Multi-Timbral Sequence</i>	151
<i>Recording MIDI SysEx</i>	153
<i>Erase</i>	153
<i>Export</i>	154
<i>Jukebox</i>	156

Effects

DUAL EFFECT PROCESSORS

It is important to note that the E4K contains two stereo effects processors which serve the entire machine. When playing presets one at a time, the two processors can be programmed as part of the preset. When in multimode, a global effects assignment is used. The diagram below shows how the effects are integrated into the signal path using a parallel effects send/return model, similar to a mixing console.

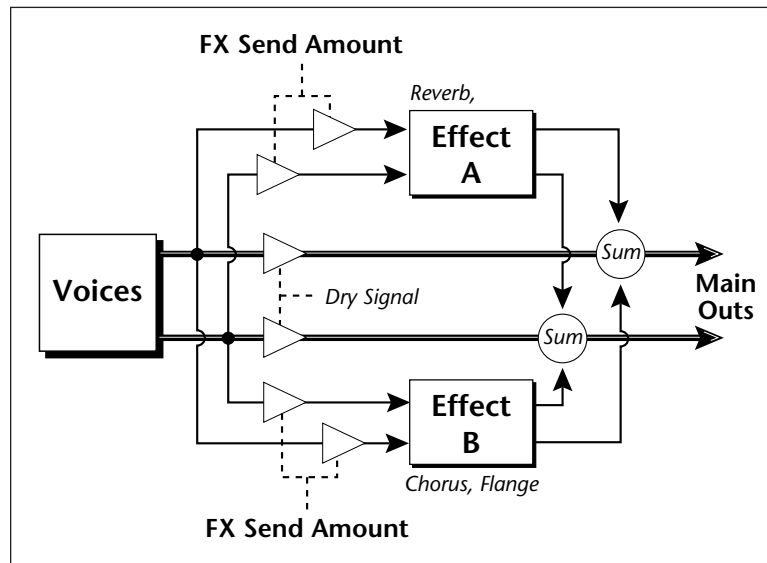

■ **Note:** Unlike a mixing console, the dry signal begins to be attenuated as the Send Amount is increased beyond 50%. This allows a mix of 100% effect.

Effect processor “A” contains Reverb and Delay effects and Effect processor “B” contains Chorus and Flange type effects. There are 44 “A” effects and 27 “B” effects. In addition to the effect type there are two user adjustable parameters for each effect. The “A” effects have user programmable Decay Time and High Frequency Damping. The “B” effects have user programmable Feedback, LFO Rate and Delay Time.

**FX
Sequencer**

THE EFFECTS SENDS

On a mixing console you can control the amount of signal each channel *Sends* to the effect bus. This allows each channel to be placed in a slightly different “sonic space” which can create an airy, open sound.

The E4K uses this basic concept, but works in a slightly different manner. On the E4K there are 4 effects busses: **Main, Sub 1, Sub 2, and Sub 3**. Each voice or each MIDI channel (you determine which), can be directed to one of the four busses. Each effect processor contains four *Send Amounts* which allow you to set the wet/dry mix on each of the four busses going into the effect. A setting of 0% is completely dry (no effect). A setting of 50% contains an equal mix of effected and normal signal.

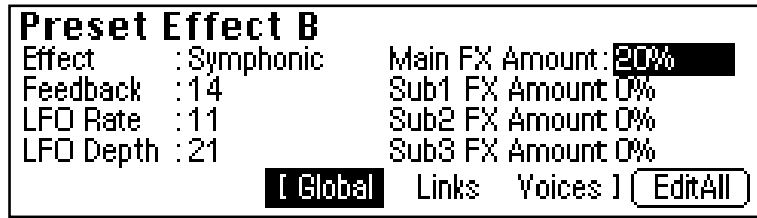

The submix bus selection is programmed for each voice in the Preset Edit, Amplifier screen. These settings can be overwritten in the Multimode screen by changing the submix setting from “Voice” to “Sub 1, 2 or 3” which routes the preset on that MIDI channel to the selected submix buss.

In the screen below, MIDI channel 4 is programmed to the submix 1 buss. MIDI channels 2, 3 and 5 obey the submix routing as programmed in each voice.

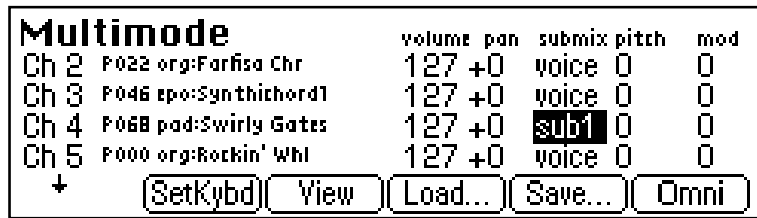

The submix buss routings are also available at the Sub Output jacks on the rear panel of the E4K. Note that these outputs contain only Dry signal. **The Effects Processors are ONLY connected to the Main Outputs.**

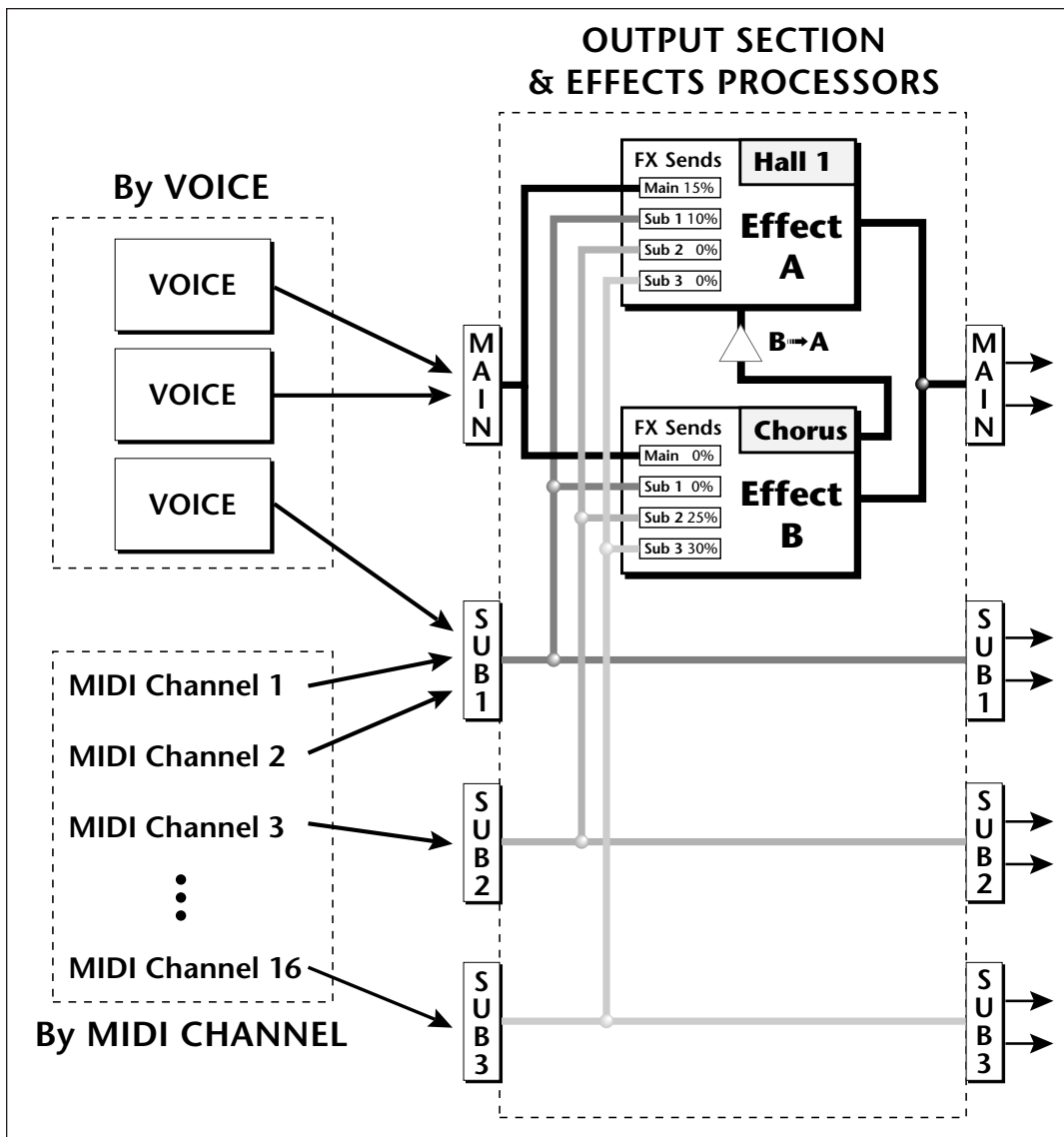

The diagram above shows how individual voices or MIDI channels can be routed to the four busses. Note that the signal lines represent stereo signals.

Tip: The dry signal is removed from the main output even if only one plug is inserted into a submix jack.

If a plug is inserted onto a Sub Output jack, the dry signal from that buss is removed from the effects processor. This feature allows you to have three dry mixes from the Sub Outputs and an "Effects Only" mix from the Main Outputs.

EFFECT B INTO EFFECT A

The output of effect processor B can be routed into effect processor A. This connects the effects in series instead of their normal parallel configuration. Two effects connected in series sound very different than the same two effects in parallel. For example, a chorus patched through reverb can turn a bland string section into a lush wall of sound. The B→A amount can also be controlled for even more flexibility.

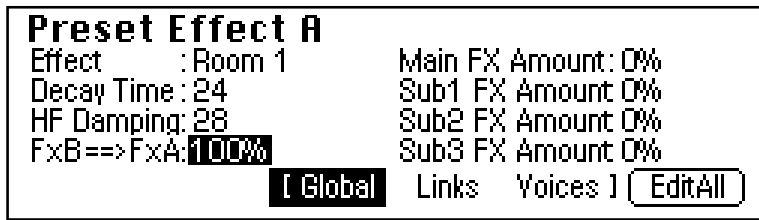

► To Send the Output of Effect B through Effect A:

In this example, 100% of Effect B will be sent into Effect A.

1. The Effect A screen (in either the Master or Preset Edit menus) contains the B→A Amount parameter. Set this amount to 100%. Turn the **Send Amounts** down to zero since we only want to hear the two effects in series.
2. Press the Next page key to select Effect B. Select an effect and adjust the Main FX A Send percentage as desired.

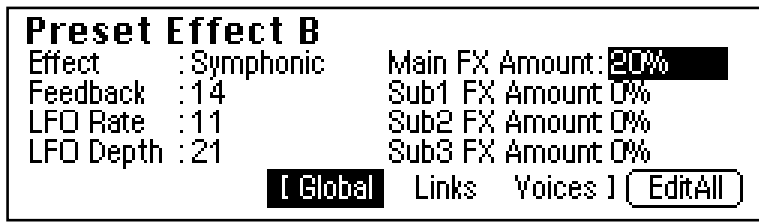

3. Play the keyboard and you should hear the B Effect running through Effect A. This patch is shown below.

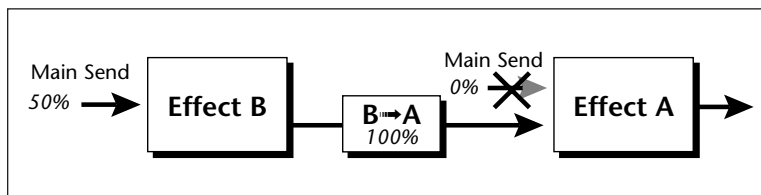

▣ Because the amounts are Sends, we want to open the Main Send to Effect B, turn B→A up full and turn the Main Send to Effect A down to zero. This sends ALL of Effect B through Effect A.

FX Sequencer

THREE-WAY EFFECTS CONTROL

The E4K is very flexible when it comes to controlling the effects processors. The effects can be controlled in three different ways to suit your personal preference and to adapt to different situations.

1. Programmed as part of the preset when playing single presets (*Omni or Poly Modes*).
2. Programmed from the Master Effects Section when playing either single presets (*preset Effect Type set to "Master"*) or when in Multi Mode.
3. Programmed from the designated control preset when in Multi Mode.

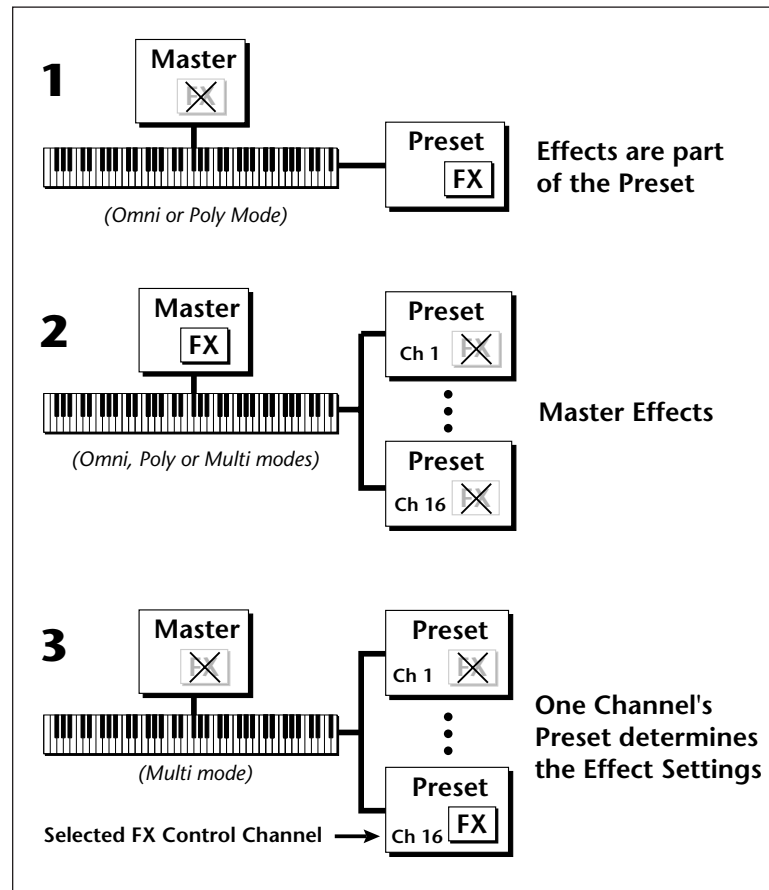

EFFECTS PROGRAMMED IN THE PRESET

When playing single presets, the effects are normally programmed as part of the preset.

► To Program the Effects as part of the Preset:

1. Press the **Preset Edit** key. The LED will illuminate and the Preset Edit screen will appear.

Voices-Main			volume	pan	ctune	ftune	xpost	orig
V1	G1	S001 OrganWave4	+5	+0	+0	+16	+6	C4
V2	G2	S002 OrganWave	-70	+0	+0	+16	+6	C4
V3	G1	S003 OrganWave	-60	+0	+0	+16	+6	C4
V4	G1	S004 OrganWave1	-70	+0	+0	+16	+6	C4

Utils SZone [Global Links Voices] Edit

- If you are in a screen where the “Global, Links, Voices” soft-keys are not visible, press the **Exit** key once.
2. Press the **Global** function key (F3). The Global menu will appear.
 3. Press the **Next page** key. The Preset Effect A menu will appear.

Preset Effect A	
Effect : Room 1	Main FX Amount: 15%
Decay Time: 31	Sub1 FX Amount 0%
HF Damping: 29	Sub2 FX Amount 0%
(unused) : 7	Sub3 FX Amount 0%

[Global Links Voices] EditAll

4. Select an Effect. Do not use the “Master Effects” setting as this will cause the Master effect settings to be used. Set the other effect parameters to your preference.
5. Press the **Next page** key again to go to the Preset Effect B menu.
6. Save the bank. The programmed effects setting will be saved along with the preset.

MASTER EFFECTS

You might want the effects to be programmed on a global basis in Omni and Poly modes. You could choose your favorite reverb, for example, and have it applied to any preset you select

► To Program the Effects Globally for all Presets:

1. Press the **Preset Edit** key. The LED will illuminate and the Preset Edit screen will appear.

Voices-Main			volume	pan	ctune	ftune	xpose	orig
V1	G1	S001 OrganWave4	+5	+0	+0	+16	+6	C4
V2	G2	S002 OrganWave	-70	+0	+0	+16	+6	C4
V3	G1	S003 OrganWave	-60	+0	+0	+16	+6	C4
V4	G1	S004 OrganWave1	-70	+0	+0	+16	+6	C4

Utils▲ SZone▲ [Global Links Voices] Edit

- If you are in a screen where the “Global, Links, Voices” soft-keys are not visible, press the **Exit** key once.
2. Press the **Global** function key (F3). The Global menu will appear.
 3. Press the **Next** page key. The Preset Effect A menu will appear.
 4. Select the Effect to the “Default” setting, which will cause the Master effect settings to be used.
 5. Press the **Next** page key again to go to the Preset Effect B menu. Set the Effect to the Default setting if you wish the Master settings to be used.
 6. Change each preset in the bank to the Default setting if you want the Master Effect setting used on all presets.
 7. Save the bank.

USE MASTER EFFECTS SETTINGS IN MULTI MODE

In Multi Mode the two effects processors can be either controlled from the Master Effects settings or they can follow the effects settings of the preset on a special MIDI channel. Because up to 16 presets can play at once in multi mode, the effects cannot be programmed at the preset level. There are only two effect processors!

► **To Program the Effects Globally for all Presets:**

1. Press the **Master** key. The LED will illuminate and the Memory Statistics screen will appear.

Memory Statistics				
Type	Total	Used		
Preset	544k	95k	17%	
Sample	4mb	3.86mb	96%	
[Utils▲] [Bank▲] [Setup▲] [FX▲] [SeqMgr] [MIDI▲]				

2. Press the **MIDI** function key (F6). A second row of MIDI options will appear.

Memory Statistics				
Type	Total	Used		
Preset	503k	413k	82%	
Sample	8mb	7.98mb	99%	
[Mode] [Cntrl1] [Cntrl2] [Prefs1] [Prefs2]				

3. Press the **Mode** function key (F1). The MIDI mode menu will appear.

← PREV		MIDI Mode	NEXT →
[F1]	Basic Channel :	1	MIDI Controllers 1
[F2]	MIDI mode :	multi	
[F3]	Local Control :	on	
[F4]	Multi mode Effects Control Channel :	off	

4. Move the cursor to the Effect Control field using the cursor keys or by pressing the F4 key.
5. Set the Effect Control channel to **Off** using the data entry control or inc/dec keys.
6. Press the **Exit** key three times to save the settings and return to the main screen.



USE THE EFFECTS CHANNEL SETTINGS IN MULTI MODE

In Multi Mode, the effect settings can follow the effects settings of the preset on a special MIDI channel. You designate one MIDI channel as the “Multimode Effects Control Channel”. When this is done, the effects processors will follow the effects setting made in the preset assigned to this MIDI channel. This powerful feature allows you to change effects during a sequence and to control the effects amounts and settings from a sequencer using continuous controller messages.

► To Set the Effects Control Channel:

1. Press the **Master** key. The LED will illuminate and the Memory Statistics screen will appear.

Memory Statistics			
Type	Total	Used	
Preset	544k	95k	17%
Sample	4mb	3.86mb	96%
<div style="display: flex; justify-content: space-between; padding: 0;"> Utils▲ Bank▲ Setup▲ FX▲ SeqMgr MIDI▲ </div>			

2. Press the **MIDI** function key (F6). A second row of MIDI options will appear.
3. Press the **Mode** function key (F1). The MIDI mode menu will appear.

← PREV	MIDI Mode	NEXT →
		MIDI Controllers 1
[F1]	Basic Channel : 1	
[F2]	MIDI mode : multi	
[F3]	Local Control : on	
[F4]	Multimode Effects Control Channel : 10	

4. Move the cursor to the Effect Control field using the cursor keys or by pressing the F4 key.
5. Select the Effect Control channel using the data entry control or inc/dec keys.
6. Press the **Exit** key three times to save the settings and return to the main screen.

EFFECTS BYPASS

This control provides a true bypass the effects engine. This is a useful feature if you are using external effects at the mixing console and want to turn the effects Off for all presets.

► To Bypass the Effects:

1. Press the **Master** key. The LED will illuminate and the Memory Statistics screen will appear.

Memory Statistics					
Type	Total	Used			
Preset	544k	95k	17%		
Sample	4mb	3.86mb	96%		
Utils▲ Bank▲ Setup▲ FX▲ SeqMgr MIDI▲					

2. Press the **FX** function key (F4). A second row of Effects options will appear.

Memory Statistics					
Type	Total	Used			
Preset	544k	95k	17%		
Sample	4mb	3.86mb	96%		
FxA FxB Bypass					

3. Press the **Bypass** function key (F3). The Effects Bypass screen will appear.

← PREV	Effects Bypass	NEXT →
Master Effect B		
Effects Engine: Enabled		

4. Enable or disable the Effects Engine using the data entry control or inc/dec keys.
5. Press the **Exit** key three times to save the settings and return to the main screen.



Effect Descriptions

► A EFFECT TYPES

Room 1-3	Large Concert
Hall 1 & 2	Large Concert Pan
Plate	Canyon
Delay	DelayVerb 1-3
Panning Delay	DelayVerb 4-5 Pan
Multitap 1	DelayVerb 6-9
Multitap Pan	
3 Tap	
3 Tap Pan	
Soft Room	
Warm Room	
Perfect Room	
Tiled Room	
Hard Plate	
Warm Hall	
Spacious Hall	
Bright Hall	
Bright Hall Pan	
Bright Plate	
BBall Court	
Gymnasium	
Cavern	
Concert 9	
Concert 10 Pan	
Reverse Gate	
Gate 2	
Gate Pan	
Concert 11	
Medium Concert	

► B EFFECT TYPES

Chorus 1-5
Doubling
Slapback
Flange 1-7
Big Chorus
Symphonic
Ensemble
Delay
Delay Stereo 1 & 2
Panning Delay
Delay/Chorus
Pan Delay Chorus 1 & 2
Dual Tap 1/3
Dual Tap 1/4
Vibrato

Reverb

Reverberation is a simulation of a natural space such as a room or hall. The reverb effects in the E4K simulate various halls, rooms and reverberation plates. In addition, there are several other reverb effects such as Gated Reverbs Multi Tap (early reflections), Delay and Panning effects. There are two adjustable parameters on the reverb effects - Decay Time and High Frequency Damping.

Decay time is the time it takes for the reflected sound from the room to decay or die away. The diagram below shows a generalized reverberation envelope.

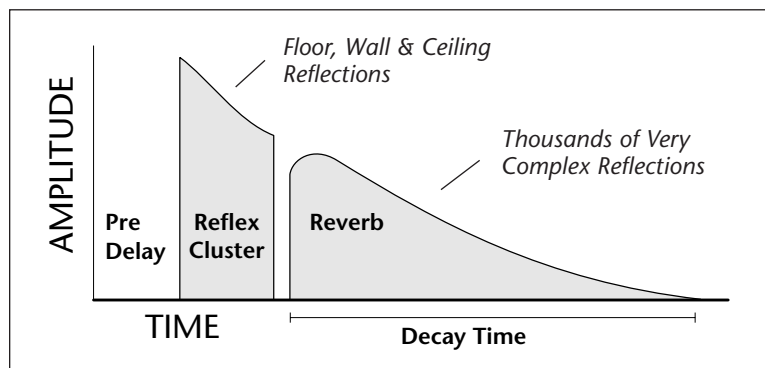

After an initial pre-delay period, the echoes from the closest walls or ceiling are heard. These first echoes or the *early reflection cluster*, vary greatly depending on the type of room. Roughly 20 milliseconds after the early reflection cluster, the actual reverberation begins and decays according to the time set by the **Decay Time** parameter.

High frequency energy tends to fade away first as a sound is dissipated in a room. The **High Frequency Damping** parameter allows you adjust the amount of high frequency damping and thus change the characteristics of the room. Rooms with smooth, hard surfaces are more reflective and have less high frequency damping. Rooms filled with sound absorbing materials such as curtains or people have more high frequency damping.

General Descriptions

Room programs simulate small rooms with high frequency absorption caused by drapes and furniture.

Plates simulate plate type reverbs with their tight, dense early reflections and sharp reverb buildup.

Hall programs recreate the open, spacious ambience of large concert halls.

Gated Reverbs add ambience only while the original signal is still sounding. As soon as the signal falls below a threshold, the reverb is automatically cut off.

Delay programs can be used to create echo and doubling effects.

Multi Tap programs consist of the reflection cluster only without the reverb decay.

Chorus

The function of a chorus device is to thicken the sound or to make one voice sound like many. The way the effect is achieved is by mixing one or more delayed versions of the signal in with the original. The delay times used are too short to be perceived as an echo, but long enough so that comb filtering does not occur. In addition, the delay time is varied via a low frequency oscillator to simulate the random differences which occur when multiple instruments are playing together. A slight amount of feedback improves the effect by creating multiple images of the sound as it recirculates again and again.

All the choruses are true stereo using two separate delay lines controlled by a single set of controls. The delay times are slightly different for each channel and the LFO phase is inverted on one channel to help contribute to the overall chorus effect. The LFO Rate and Depth settings are critical to achieving a realistic effect with faster LFO rates generally requiring less LFO amount and vice-versa.

Doubling

When a copy of a sound delayed by about 26 milliseconds is added back with the original, two audio images can be perceived by the brain. When the delayed image is slightly varied or modulated, the illusion of two voices is created.

Slapback

Slapback is a single short echo in the range of 50-60 milliseconds. A sound delayed by this length of time is perceived as a discrete and separate image which is useful for a thickening effect or as a pre-delay for reverb simulating a hard, reflective surface such a gymnasium wall.

Stereo Flanger

A flanger consists of a short audio delay line whose output is mixed together with the original signal. Mixing the delayed and original signals together results in multiple frequency cancellations creating a comb filter effect as shown in the diagram below. Since the flanger is a type of filter, it works best with harmonically rich sounds such as strings.

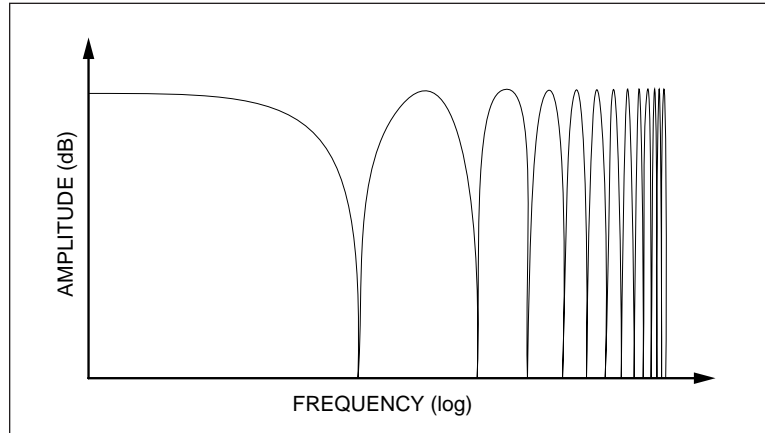

The flanging effect was originally created using two tape recorders playing identical recordings. By exactly synchronizing the two decks and then slowing the speed of one by grasping the tape reel flanges, the flanging effect was born.

The flanger is a stereo device consisting of two separate delay lines controlled by a single set of controls. A Low

Frequency Oscillator (LFO) varies this initial delay setting, changing the frequency of the notches and adding animation to the sound. The LFO Rate controls the rate of change and the LFO Depth controls how much the delay is changed by the LFO.

The Feedback control sends some of the delayed signal through the delay line again. When feedback is used the comb filter notches are deepened.

Delay

The delay on the E4K is an effect which can be used for doubling, reverb pre-delay, or echoes.

Delay Time is variable from 0-635 mS and controls the time between echoes and Feedback controls how long the echoes continue sounding. "Infinite" delay effects are also possible without the risk of runaway.

Stereo Delay

Similar to delay except that the delay line outputs a stereo signal from the mono input. The two output signals are a few milliseconds apart to create a stereo image. The delay times is variable from 0-635 mS.

Panning Delay

A panning delay is similar to the normal delay lines except that the echoes bounce back and forth between the two stereo speakers.

Dual Tap

These are delay lines where the signal is "tapped off" at two unevenly spaced locations. When feedback is used, multiple complex echoes are produced. The fraction in the name (i.e. 1/3, 1/4) refers to the distance between the taps.

Vibrato

Basically, this a delay line modulated by an LFO, but with none of the original signal added in. The LFO modulation creates a Doppler shift and a resultant cyclical pitch shift. The vibrato created in this manner sounds very different than vibrato created by frequency modulating the sample.

Sequencer Manage

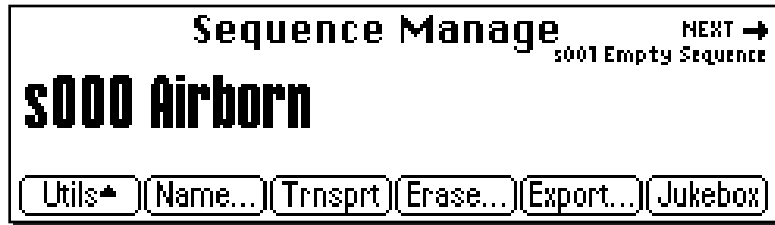

The Sequencer Manage menu contains additional sequencer options. The E4K sequencer was designed to be a “scratchpad”, to capture your musical ideas. Sequences can then be exported as Standard MIDI Files to a full-featured computer sequencer for editing. Edited sequences can later be re-loaded back into the E4K. Up to 10 sequences can be recorded and are saved when you save the bank. The note capacity depends entirely on how much memory you allocate to sequences, and ranges from approximately 350 to over 97,000 notes. The sequencer has 16 tracks and can record program changes, controller changes and SysEx data as well as note and velocity information.

Tip: The Memory Configuration function, located in the Master, Setup menu, allows you to set the amount of sequencer memory.

The Sequence Manage menu contains six submenus:

- **Utilities** - Contains Copy, Info, Setup functions, Time display, Memory Status and the Jukebox.
- **Name** - Allows you to name your sequences.
- **Transport** - The front panel transport controls can control either the internal sequencer, an external sequencer or another device via MIDI Machine Control. This screen also controls the status of each track. The four track states are: Record, Play, Mute and Solo.
- **Erase** - Allows you to erase the current sequence.
- **Export** - Allows you to export the currently selected sequence as a Standard MIDI File.
- **Jukebox** - Allows you to play up to ten sequences in series.



► **To Enter the Sequencer Manage Menu:**

Press the Sequencer key. The sequencer menu shown on the previous page will appear.

► **To Change the Current Sequence:**

From the Sequence menu, use the data entry control or inc/dec keys to select one of the ten sequence locations.

SEQUENCER TRANSPORT CONTROLS

These controls should look familiar to you. They work exactly like the controls on a cassette deck or any other tape recorder.

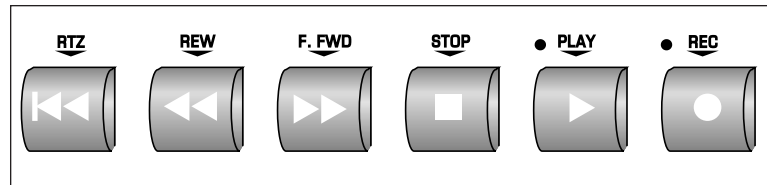

RETURN TO ZERO ... Resets the sequence to the beginning.

REWIND Moves backward through the sequence.

FAST FORWARD Moves forward through the sequence.

STOP Immediately stops the sequence.

PLAY Starts the sequence playing from its current position.

RECORD Initiates recording (*when pressed in combination with Play*).

▣ **Note:** A new track will be automatically assigned each time you go into record mode.

⚡ **Tip:** To go out of Record mode without recording, press Stop.

► **To Record a Sequence:**

Press the front panel **Record** button, (the red LED will be flashing) then press the **Play** button.

► **To Play Back a Sequence:**

Press the front panel **Play** button. To start the sequence from the beginning, press the **RTZ** (Return-To-Zero) button first.

UTILITIES

The Sequencer Utilities submenu contains several additional functions. Pressing the Utils function key from the sequencer menu enables a second row of soft keys.

- **Copy:** Allows you to copy the current sequence to another sequence location.
- **Info** - Shows the size and number of tracks used in the current sequence.
- **Setup:** Contains several sequencer setup functions: Clock Type, Loop Mode and Record Mode.
- **Time:** Allows you to set the tempo, meter and tempo for the sequence. This menu also displays a readout of the elapsed time and beats and measures in the sequence.
- **Memory:** Displays the amount of sequence memory remaining.

Copy

The currently selected sequence can be copied to any of the other sequence locations. **Caution:** Copying a sequence will overwrite the sequence (if any) in the destination location.

► To Copy a Sequence:

1. From the Sequencer menu, select the sequence you wish to copy using the data entry control or the inc/dec keys.
2. Press the **Utils** function key (F1).
3. Press the **Copy** function key (F1). A pop up dialog box will appear asking you to select the destination sequence location.
4. Select the destination sequence location using the numeric keys, data entry control, inc/dec keys or using an ASCII keyboard.
5. Press **OK** to confirm the operation or **Cancel** to cancel the operation.



Info

The E4K will display the size in bytes and the number of tracks in the currently selected sequence.

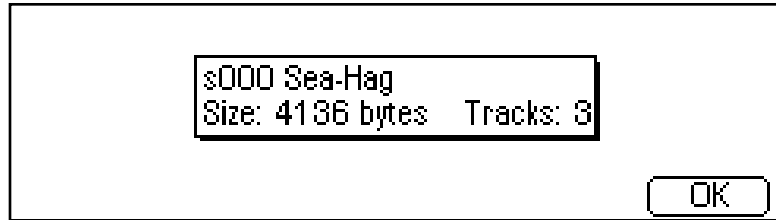

► To Get Sequence Info:

1. From the Sequencer menu, select the sequence you wish to get info about using the data entry control or the inc/dec keys.
2. Press the **Utils** function key (F1).
3. Press the **Info** function key (F2). A pop up dialog box will appear with the vital statistics on the selected sequence.
4. Press **OK** (F6) to return to the Sequence Manage screen.

Setup

This menu contains four setup options.

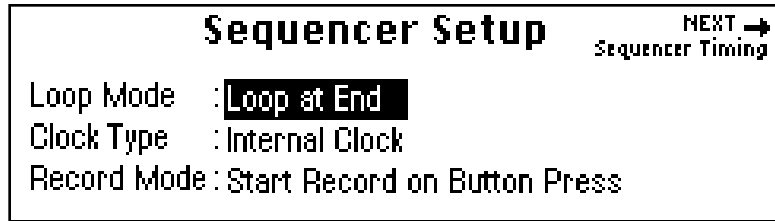

Tip: A sequence will be looped from the end of the last event, not the end of the last bar. If you import a sequence from your computer, prepare it for looping by extending the duration of the final note to the end of the final bar. This will keep the time signature constant when played back on the E4K.

Clock Type: Select between internal clock or external MIDI clock.

Loop Mode: There are two options:

- Stop at Sequence End: Sequence plays to the end and stops.
- Loop at Sequence End: Sequence plays to the end then starts again, playing continuously until the Stop button is pressed.

Record Mode: There are two options:

- Start Record on Button Press: Sequence begins recording the instant Record and Play are pressed simultaneously.
- Start Record on Button Press: Sequence begins recording when the first keyboard key is pressed. Program changes and continuous controllers can be recorded *before* the first note is pressed.

► To Program the Sequencer Setup Options:

1. From the Sequencer menu, press the **Utils** function key (F1).
2. Press the **Setup** function key (F3). The dialog box shown above will appear.
3. Move the cursor to the desired option using the cursor keys and change the parameter using the data entry control or inc/dec keys.
4. Press **Exit** to return to the Sequence Manage menu.



Sequence Timing

This screen allows you to change the playback tempo and meter of a sequence. The meter only affects the bars/beats display. It doesn't affect the timing of a sequence.

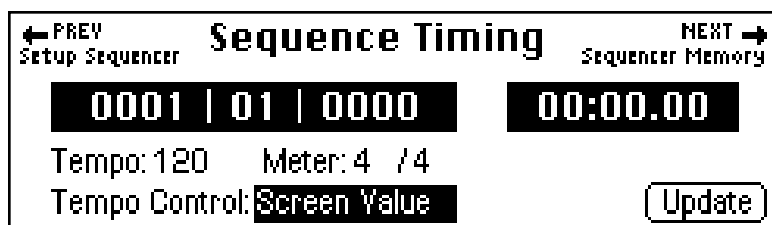

While a sequence is playing or recording, the time will be displayed both in bars and beats and in minutes and seconds. When a sequence is stopped, ticks and hundredths of seconds are also displayed.

The Tempo Control allows the tempo of the sequence to be controlled by the value stored in the sequence (the Tempo Track) or by the screen tempo value that you can change. An update button allows you to set the start tempo of any sequence to the displayed screen value.

► To Change the Tempo and Meter:

1. From the Sequencer menu, select the desired sequence using the data entry control or the inc/dec keys.
2. Press the **Utils** function key (F1). A second row of function keys will appear.
3. Press the **Time** function key (F4). The dialog box shown above will appear.
4. Change the Tempo Control to **Screen Value** using the right cursor key to select the field and the data entry control, or inc/dec keys..
5. Move the cursor to the Tempo field and change the **Tempo** using the data entry control, or inc/dec keys to change the value.
6. Press **Update** if you wish to change the starting tempo of the sequence to the displayed tempo.
7. Press the **Exit** key to return to the Utilities screen.

Sequencer Memory

This screen displays the sequencer memory status. You can enable this screen while recording to monitor sequence memory usage.

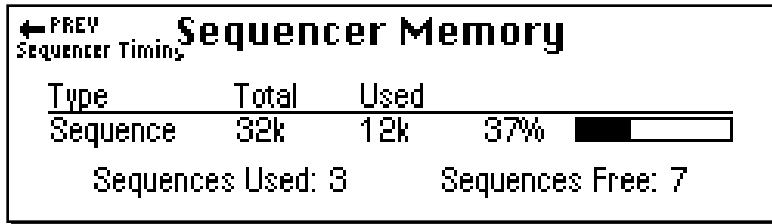

► To Check the Sequencer Memory:

1. From the Sequence menu, press the **Utils** function key (F1).
2. Press the **Memory** function key (F5). The dialog box shown above will appear.
3. Press **Exit** to return to the Sequencer Manage screen.



NAME SEQUENCE

This function allows you to name a sequence.

► To Name a Sequence:

1. From the Sequencer menu, select the sequence you wish to name using the data entry control or the inc/dec keys.
2. Press the **Name** function key (F2). A pop up dialog box will appear asking you to enter the new preset name.
3. Name the sequence. Letters can be selected using the numeric keys, data entry control, inc/dec keys or using an ASCII keyboard.
4. Press **OK** to confirm the operation or **Cancel** to cancel the operation.

TRANSPORT

This screen contains several functions. First, it allows you to change the function of the front panel sequencer transport buttons. These buttons can control the internal sequencer, an external sequencer or a MIDI Machine control device such as a digital tape machine or hard disk recorder. The MIDI Machine Control ID number can be set to any number from 0-127. You should match this number to the ID of the machine you wish to control.

The buttons at the bottom of the screen duplicate the functions of the front panel transport controls. The currently selected function is shown in reverse text.

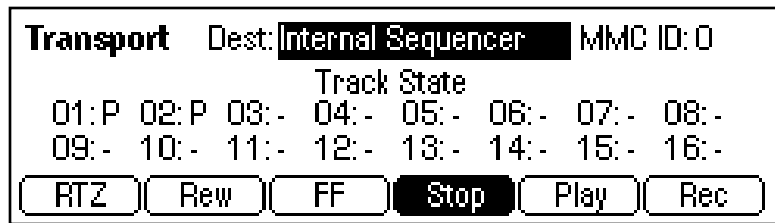

This menu also allows you to change the track status of the 16 sequencer tracks. Several track status options are available.

P: Plays the track.
M: Mutes the track.
S: Solos the track. Solo mutes all other tracks and plays only those tracks in solo mode.
R: Puts the track in record mode.
- : Indicates that the track is empty.

■ **Note:** A new track will be automatically assigned each time you go into record mode.

- Recording onto a track erases anything previously recorded there.

► **To Change the Transport Client:**

1. Press the **Sequencer** key.
2. Press the **Trnsprt** function key (F3). The transport menu shown below will appear.

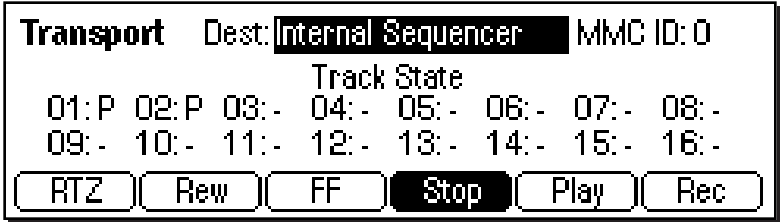

3. The cursor defaults to the Destination field. Use the data entry control, or inc/dec keys to select internal sequencer or MIDI Machine Control.
4. Move the cursor to MMC ID and change the number to match the ID of the MMC machine you wish to control.
5. Press **Exit** to return to the Sequence Manage screen.

► **To Change the Track Status:**

1. Press the **Sequencer** key.
2. Press the **Trnsprt** function key (F3). The Transport menu shown above will appear.
3. Use the cursor keys to move the cursor to the desired track field.
4. Change the track status to the desired state.
5. Press **Exit** to return to the Sequence Manage screen.

■ **Notes:** A track can contain multiple channels, whether recorded in or imported via MIDI file.

Regardless of channels, only 16 tracks can be in the MIDI file or it won't load.

Tip: If you wish to control an E-IV's sequencer with an E4K, set the E4K's MMC ID to 24 or 127.

**FX
Sequencer**

► **To Use the Transport Controls In MMC Mode:**

When the Transport Destination is set to MIDI Machine Control, the internal sequencer is disabled and the sequencer controls function as a remote control for an MMC recorder. The tracks on the transport screen can be set to either Record (R) or Play (P) and will control the record enables on the MMC recorder. The front panel controls operate the standard record, play, stop, fast-forward and reverse controls on the MMC machine.

1. Press the **Sequencer** key.
2. Press the **Trnsprt** function key (F3). The transport menu will appear.
3. Use the data entry control, or inc/dec keys to select MIDI Machine Control.

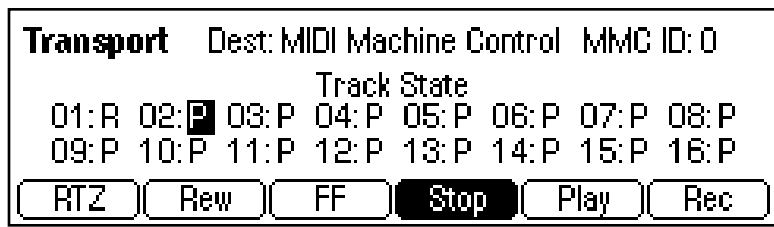

4. Move the cursor to MMC ID and set the ID to match the ID of the external MMC machine you wish to control.
5. Move the cursor down to the track state. The track state now control the track record enables on the external MMC device.
6. The front panel sequencer transport controls will now control the external MMC recorder.
7. Press **Exit** to return to the Sequence Manage screen.

Received MMC Commands

The E4K always receives the following MMC commands:

Record Exit - Same as Stop	Record Strobe - Begins recording at beginning of sequence.
Stop	
Fast Forward	Play
Rewind	
Locate - Same as RTZ	

► **To Record a Multitimbral Sequence:**

1. From the main screen, press the **Arrow** function key (F6) in the lower left corner of the display.

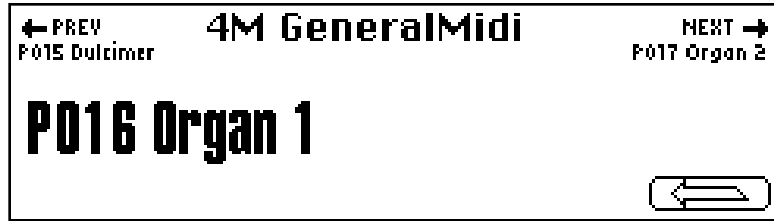

Four additional soft key choices will appear.

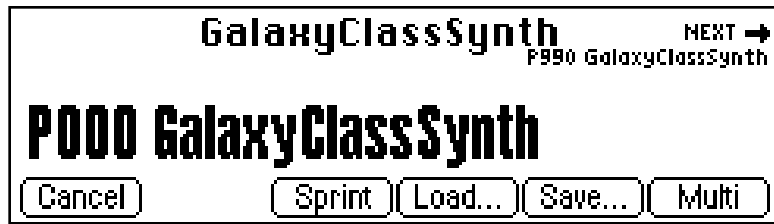

2. Press the **Multi** function key (F6). The following screen will appear.

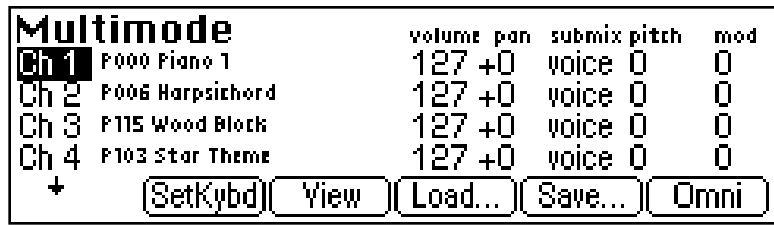

3. Use the up/down cursor keys to select the MIDI channel you want to record. (Ch 1 might be a good place to start.) Press **SetKybd** (F2) to select the MIDI channel. The selected channel will be recorded on the first track.
4. Move the cursor to the preset field and select a preset.
5. On the sequencer transport controls, press **Record**, then press **Play**. Begin playing the keyboard.
6. Press **Stop** when you have finished playing.
7. Press **RTZ** to return the sequence to the beginning of the song.

8. Press **Play**. The sequence should play back exactly as you played it.
9. If you are happy with your performance you are ready to record the next track, press **SetKybd** (F2) to select another MIDI channel. The next track will automatically be selected when you go into Record mode again. You may also want to change the preset associated with the new channel. **Hint:** You can play back the sequence as you audition presets.
 - If you made a mistake and want to play the track over, press the **Sequencer** key, then **Erase** to erase the sequence. The first recorded track of a sequence determines its length.
10. On the sequencer transport controls, press **Record**, then press **Play**. Begin playing the keyboard to record on track two.
11. Press **Stop** when you have finished playing.
12. Press **RTZ** to return the sequence to the beginning of the song.
13. Press **Play**. The sequence should play back with the two tracks using two different presets.

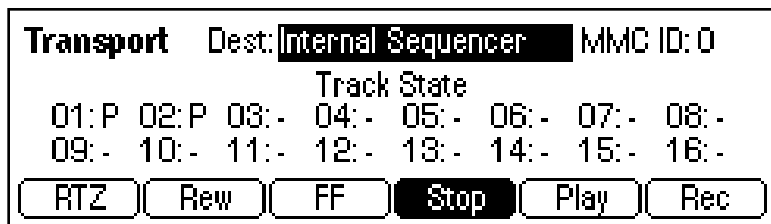

Tip: Multitimbral Recording:

1. Select the Channel in the Multimode screen.
2. Select the Preset you want associated with the channel in the Multimode screen.
3. Record-Enable the Track in the Sequencer Transport screen.
4. Begin recording.

14. If you make a mistake on a track, go to the Transport screen and reset the track status to **R** (record). Then re-record the track.
15. Try out the Solo and Mute modes on one of the tracks. You can adjust the volume and pan position of each channels in the Multimode screen.
16. After recording, you can change the presets associated with each channel in the Multimode screen.

RECORDING MIDI SYSEX

You can also use the sequencer as a MIDI data filer to record SysEx messages such as control data or programs for another MIDI instrument.

► To Record a SysEx Message:

1. Connect MIDI Out of the external device to MIDI In on the E4K.
2. Start the sequencer recording and send the SysEx data.
3. Stop the sequencer when the transmission is finished.

► To Play Back a SysEx Message:

Simply play back the sequence with MIDI Out connected to MIDI In on the receiving device.

ERASE

This function allows you to erase a sequence.

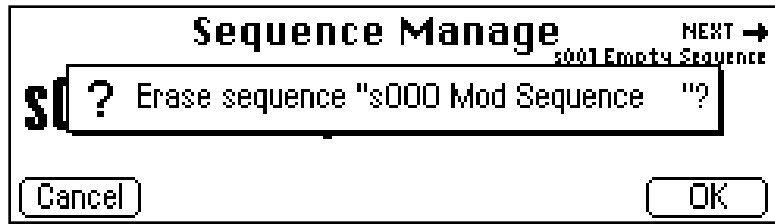

► To Erase the Sequence:

1. Press the **Sequencer** key.
2. Select the sequence you wish to erase using the data entry control or inc/dec keys.
3. Press the **Erase** function key (F4). The pop up dialog box shown above will appear asking you if you really want to erase the sequence.
4. Press **OK** to erase the sequence or **Cancel** to cancel the operation.

EXPORT

This function allows you to export a sequence as a Standard MIDI File or as an EIV bank. Standard MIDI Files or SMFs are compatible with most computer based sequencers. The E4K uses the MS-DOS format on its floppy disks, to facilitate easy file transfers between either IBM or Apple computers.

Exporting a sequence as an EIV bank allows you to transfer sequences between two machines and also allows you to combine sequences from different banks.

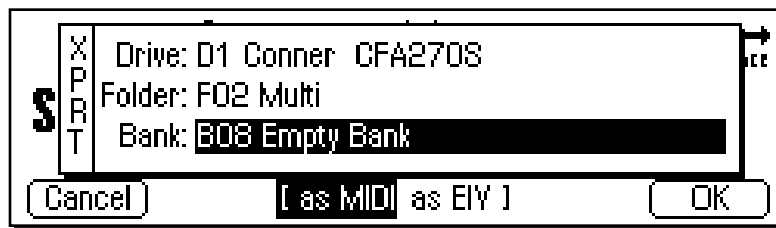

► To Export a Sequence:

1. Press the **Sequencer** key.
2. Select the sequence you wish to export using the data entry control or inc/dec keys.
3. Press the **Export** function key (F5). The pop up dialog box shown above will appear.
4. Select the destination for the exported sequence by using the cursor keys to select the field and the data entry control or inc/dec keys to change the selection. If you are exporting to a floppy disk, insert a DOS formatted disk into the drive.
5. Select either **MIDI** (Standard MIDI File) or **EIV** as the file type.
6. Press **OK** to export the sequence or **Cancel** to cancel the operation.

► To Load a Standard MIDI File from Floppy Disk:

The E4K can load and play Standard MIDI File sequences (type 0 or 1). Sequence files should conform to PC DOS format using a DOS formatted disk and using the following format for the file name: **12345678.MID** (up to eight characters followed by “.MID”). It is important to note that Standard MIDI Files appear as **Banks**, NOT as sequences in the sequence browser.

1. Insert a DOS formatted floppy disk containing the Standard MIDI Files.
2. From the Disk Browser, select the floppy drive.
3. Press Browse again and select **Banks**. The MIDI sequences will appear as banks.

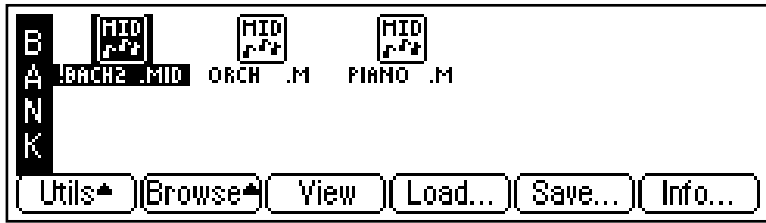

4. Press the **Load** function key (F4). A pop up dialog box will appear warning you that loading will destroy the resident bank.
5. Press the **Merge** key (F4). The selected sequence will be merged into the current bank, and will be placed in the first empty sequence location.
6. Press **OK** to load the selected sequence or **Cancel** to cancel the operation.

Important Information for Loading Standard MIDI Files

- Use PC DOS formatted diskettes to load from floppy. Disks can be formatted on either the Mac or PC.
- To be readable by the E4K the file **MUST** have 0-8 characters, then a period, then “MID”. (The “MID” part must be all capital letters.) **Example:** 12345678.MID
- Regardless of channels, only 16 tracks can be in the MIDI file or it won't load.

Tip: If a Standard MIDI File is too large to fit into the E4K memory, try re-recording it from the sequencer into the E4K MIDI port. Files will generally use much less memory when imported this way.

Tip: Plan your tracks **BEFORE** exporting from the computer. If you've done the kick drum, snare drum and hi-hat all on separate tracks, combine them before exporting to conserve tracks on E4K.

Sequencer
FX

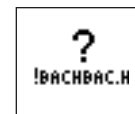

Tip: If the file name does not conform to the proper format, the question mark icon shown above will appear. Rename the file according to the file name requirement using the “Name Bank” function. The icon will look normal and the sequence will merge properly.

JUKEBOX

The jukebox allows you to play up to eight sequences in series. After the last selection is played, the jukebox will loop back to the first sequence. The jukebox starts on the current selection. If you move the cursor to a different selection, it will jump to that selection after finishing the current selection.

You MUST be in the Jukebox screen for it to operate.

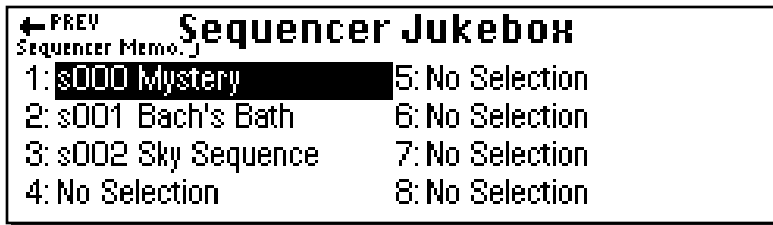

► To Play Sequences from the Jukebox:

1. From the Sequencer menu, press the **Jukebox** function key (F6). The screen shown above will appear.
2. Select the desired sequence order using the cursor keys and data entry control or inc/dec keys.
3. Press **Play** to begin playing the jukebox selections.
4. Press **Exit** to return to the Sequence Manage screen.

Sample Manage

Overview	159
Utilities	160
<i>Erase Sample</i>	160
<i>Copy Sample</i>	161
<i>Sample Dump</i>	161
<i>Defragment Memory</i>	163
Name Sample	164
Create Sample	165
<i>Left/Right Channels</i>	165
<i>Source & Rate</i>	166
<i>ADC Gain</i>	167
<i>Threshold</i>	168
<i>Sample Length</i>	168
<i>Arm Sample</i>	169
<i>Force Sample</i>	169
<i>Monitor On/Off</i>	169
<i>Keyboard Sample Trigger</i>	170
<i>Automatic Parameters</i>	171
Place Sample	175
Export Sample	175
Get Info	176

SAMPLE MANAGE



This “recording studio” module records sounds from the outside world into the bank. Features include adjustable preamp gain, variable threshold setting, and adjustable sample rate and length. Samples can also be named, copied, erased and automatically placed on the keyboard.

The Sample Manage menu contains six main sub menus:

- **Utilities** - Contains the Erase, Copy, Defragment and MIDI sample dump functions.
- **Name** - Allows you to name your samples.
- **New** - The recording studio where sounds are sampled into the E4K. This module also contains automatic DSP and setup functions such as auto-truncate, auto-normalize, auto-sample placement, auto looping.
- **Place** - Allows you to assign the sample to any range of notes on the keyboard.
- **Export** - Allows you to export a sample into another bank.
- **Info** - Displays information on the selected sample.



Utilities

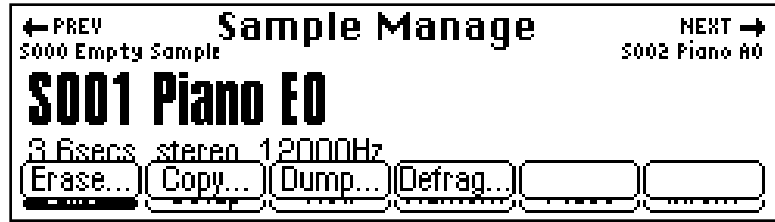

The Sample Utilities menu contains several functions.

- Erase Sample
- Copy Sample
- Sample Dump
- Defragment Memory

ERASE SAMPLE

Individual samples can be erased from the bank using this function.

► To Erase a Sample:

1. Press the **Sample Manage** key. The LED will illuminate and the main screen will appear.
2. Select the sample to be erased using the data entry control, inc/dec keys, or the numeric keypad.
3. Press the **Utils** function key (F1). A second row of soft keys will appear.
4. Press the **Erase...** function key (F1). A pop-up dialog box will appear asking you if you want to erase all presets and samples.
5. Press **OK** to erase the bank or **Cancel** to cancel the operation.

Sample
Manage

6. A pop-up dialog box will appear asking you if you want to defragment memory after erasing.
7. Press **Yes** to defragment memory and erase the sample. Press **No** to erase the sample without defragmenting memory, or **Cancel** to cancel the entire operation.

■ **Note:** For more information about Defragmenting Memory, see page 163.

COPY SAMPLE

Samples can be copied to other sample numbers within the bank.

► To Copy a Sample:

1. Press the **Sample Manage** key. The LED will illuminate and the main screen will appear.
2. Press the **Utils** function key (F1). A second row of soft keys will appear.
3. Press the **Copy...** function key (F2). A pop-up dialog box will appear asking you to select the destination sample location.
4. Select the destination sample location using the data entry control, inc/dec keys or the numeric keypad.
5. Press **OK** to copy the sample or **Cancel** to cancel the operation.

SAMPLE DUMP

MIDI Sample Dump allows sample data to be transferred to and from the E4K using the MIDI Sample Dump Standard. This is a way of transferring samples to and from other samplers. Although none of the preset parameters are transferred, sample loop data is retained. If imported samples have loop problems such as “ticks or pops”, the Sample Integrity function (Sample Edit, Utilities) may be able to automatically repair them. Otherwise adjust the loop points.

The E4K can transmit sample data with a word size of either 14 or 16 bits (Certain instruments require the use of the 14 bit word size). In addition, for instruments that use 14 bits or less, 14 bit mode transmits data 30% faster.

Before initiating MIDI Sample Dump, make sure that the MIDI cables are properly connected. A single MIDI cable (open-loop) is sufficient but the data transfer will be much faster if two MIDI cables are used (closed-loop). The closed-



loop allows the two units to handshake and prevents idle time between each data packet. The cables should be connected between the MIDI In and MIDI Out of both units.

In the Sample Dump Standard and in the E4K, samples are assigned numbers and these numbers are the same. For example, sample #36 transferred from another device to the E4K will overwrite sample location 36.



► **To Send or Receive a Sample:**

1. Press the **Sample Manage** key. The LED will illuminate and the main screen will appear.
2. Select the sample to be transmitted or received using the data entry control, inc/dec keys, or the numeric keypad.
3. Press the **Utils** function key (F1). A second row of soft keys will appear.
4. Press the **Dump...** function key (F3). A pop-up dialog box will appear with several choices.
 - **Direction:** Select Transmit or Receive.
 - **Word Size:** Select 14 or 16 bits.
 - **Side:** If the sample is stereo, you have the option to select the right or left side.
5. Select the sample using the data entry control, inc/dec keys or the numeric keypad. Press **OK** to dump the sample or **Cancel** to cancel the operation.

When receiving a sample, the currently selected sample will be overwritten by the incoming sample.

DEFRAGMENT MEMORY

When samples are erased or truncated, empty spaces are left in the sample memory of the E4K until the bank is saved to disk. Because the memory space is not filled efficiently, we call this condition “Fragmented Memory”. Fragmented memory may limit new sample size, even though you have plenty of memory left. This function allows you manually de-fragment the memory before saving it to disk. The E4K automatically defragments when it saves a bank to disk.

► To Defragment Sample Memory:

1. Press the **Sample Manage** key. The LED will illuminate and the main screen will appear.
2. Press the **Utils** function key (F1). A second row of soft keys will appear.
3. Press the **Defrag...** function key (F4). A pop-up dialog box will appear asking you if you want to de-fragment sample memory.



4. Press **OK** to defragment memory or **Cancel** to cancel the operation.

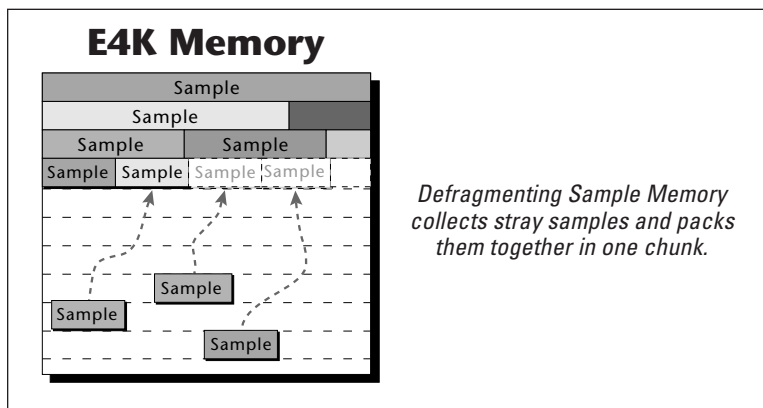

Name Sample

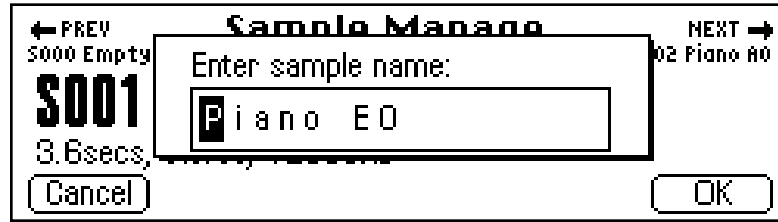

This function allows you to name or rename any sample in the bank.

► To Name a Sample:

1. Press the **Sample Manage** key. The LED will illuminate and the main screen will appear.
2. Select the sample to be named using the data entry control, inc/dec keys, or the numeric keypad.
3. Press the **Name** function key (F2). A pop up dialog box will appear asking you to enter the new sample name.
4. Name the sample. Letters can be selected using the numeric keypad, data entry control, inc/dec keys and cursor keys, or using an ASCII keyboard.
5. Press **OK** to confirm the new name or **Cancel** to cancel the operation.

**Sample
Manage**

Create Sample (New)

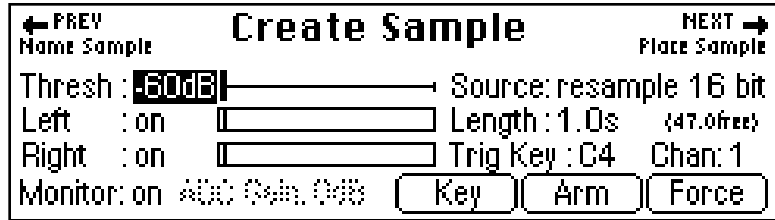

This submodule prepares the E4K for sampling. It also contains the sampling trigger controls and automatic DSP and auto-sample placement controls. The following functions are integrated into this important screen.

- Threshold
- Left and Right Input Meters
- Sample Through Monitor Select
- ADC Gain
- Sampling Source and Source Sample Rate
- Sample Length
- Arm Sample
- Force Sample
- Keyboard Sample Trigger
- Automatic DSP
- Automatic Sample Placement

LEFT/RIGHT CHANNELS

- **Left Channel:** This line shows the left input level and whether the channel is On or Off. Use the inc/dec keys or data entry control to enable or disable recording into the left channel. **When sampling in mono, use the LEFT channel ONLY.**
- **Right Channel:** This line shows the right input level and whether the channel is On or Off. Use the inc/dec keys or data entry control to enable or disable recording into the right channel. **When sampling in mono, use the LEFT channel ONLY.**

Caution: The right channel is NOT displayed in the graphic editing functions. Therefore it would be best to use the left channel when sampling in mono.



SAMPLING SOURCE & SAMPLE RATE

- **Analog Sampling:** Choose between 22.05 kHz, 24 kHz, 44.1 kHz or 48 kHz when using the analog inputs. The sample rate should be at least twice as high as the highest frequency component in the sound being sampled.
- **Digital Sampling:** Choose between 32 kHz, 44.1 kHz or 48 kHz when using the digital input. The display setting should match the sample rate of the incoming digital data, otherwise the Arm and Force Sample soft keys cannot be selected. If a digital source is not connected, the AES clock indicator on the lower line of the display will read “no AES” and sampling will be disabled.

The E4K will display a sample overload message when digital audio containing “Full Code” data (all 1's) is detected. This is a correct response and indicates that the input data has been clipped at some point. Full code data may distort in the E4K because changing the pitch may cause a slight gain increase. If possible, reduce the level of the incoming digital data to the E4K if you see an overload message.

- **Resampling:** This function allows you to resample the main outputs of the E4K as you are playing. Resampling allows you to build up extremely dense sounds or record a note sequence to be played back with a single key. There are two resampling modes, 16 bit and 18 bit. Use 16 bit mode for monophonic or duophonic passages or when you are not playing too many notes at once. 18 bit mode gives you more headroom for playing many notes at once.

► To Set the Sample Source:

1. Press the **Sample Manage** key. The LED will illuminate and the main screen will appear.
2. Press the **New** function key (F3). The “Create Sample” screen will appear.
3. Move the cursor to “Source” using the cursor keys.
4. Select the desired sampling source using the data entry control or inc/dec keys.
5. Press the **Exit** key to return to the Sample Manage screen.

ADC GAIN

ADC stands for Analog-to-Digital Converter. Set the analog sample level with the data entry control or inc/dec keys so that the left and right side meters indicate optimum sampling level. Play the sound to be sampled and observe the bar graph display. The signal level should be set so that the peak bar comes close to the extreme right side without actually reaching it. The gain is adjustable from -18 dB to +30 dB in 2 dB steps. This control has no effect on the digital input.

► To Set the ADC Gain:

1. Press the **Sample Manage** key. The LED will illuminate and the main screen will appear.
2. Press the **New** function key (F3). The following display will appear.

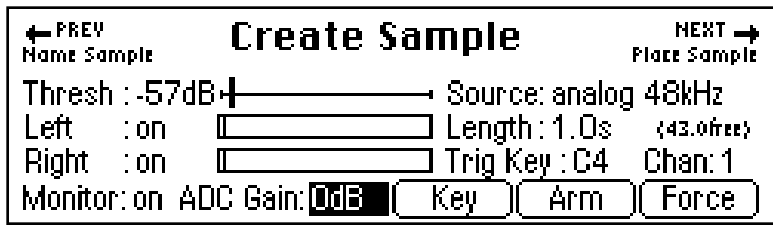

3. Move the cursor to “ADC Gain” using the cursor keys.
4. While monitoring the sound to be sampled on the VU meters, adjust the ADC Gain using the data entry control, or inc/dec keys. Set the level so that the bars never quite reach the top of the meter range.
5. Press the **Exit** key to return to the Sample Manage screen or **Arm** or **Force** to begin sampling.



THRESHOLD

In the Arm Sampling mode, sampling begins when the input signal exceeds the threshold setting. Set the sampling threshold high enough so that it is not triggered by background noise, but low enough that all of the signal is captured. Sampling is actually initiated just **before** the threshold is exceeded in order to preserve the attack transient of the sound. Presampling times are preset for 12 mS at 44.1 kHz and 17 mS at 24 kHz.

► To Set the Sample Threshold:

1. Press the **Sample Manage** key. The LED will illuminate and the main screen will appear.
2. Press the **New** function key (F3). The “Create Sample” display will appear.
3. If it is not already there, move the cursor to “Threshold” using the cursor keys.
4. While observing the input signal on the VU meters, adjust the sampling threshold using the data entry control, or inc/dec keys.
5. Press the **Exit** key to return to the Sample Manage screen.

SAMPLE LENGTH

This function allows you to select the amount of sampling (recording) time prior to sampling. The maximum available length depends on the amount of memory available and the sampling rate.

► To Set the Sample Length:

1. Press the **Sample Manage** key. The LED will illuminate and the main screen will appear.
2. Press the **New** function key (F3). The “Create Sample” display will appear.
3. Move the cursor to “Length” using the cursor keys.
4. Set the desired sample length using the data entry control, or inc/dec keys. The display shows the amount of available sampling time on the line immediately below the sample length.
5. Press the **Exit** key to return to the Sample Manage screen or Arm or Force to begin sampling.

ARM SAMPLING

Upon initiating this soft key, the E4K will begin sampling as soon as the sound to be sampled exceeds the sampling threshold.

► To Arm Sampling:

1. Press the **Sample Manage** key. The LED will illuminate and the main screen will appear.
2. Press the **New** function key (F3). The Create Sample display will appear.
3. Press the **Arm** function key (F5) to arm sampling. Sampling will commence as soon as the input signal exceeds the programmed threshold.
4. Press **Stop** or **Exit** to stop sampling before the programmed length.

FORCE SAMPLING

Upon initiating this soft key, the E4K will begin sampling immediately.

► To Force Sampling:

1. Press the **Sample Manage** key. The LED will illuminate and the main screen will appear.
2. Press the **New** function key (F3). The Create Sample display will appear.
3. Press the **Force** function key (F6) to force sampling. Sampling will commence immediately.
4. Press **Stop** or **Exit** to stop sampling before the programmed length.

MONITOR ON/OFF

Allows you to monitor the input source through the main outputs before, during and after sampling occurs. Monitoring may be turned On or Off. Normally this function will be On so that you can monitor your sample quality, but there may be instances, such as a feedback loop in your mixing board, where you would want to turn sample monitor Off.



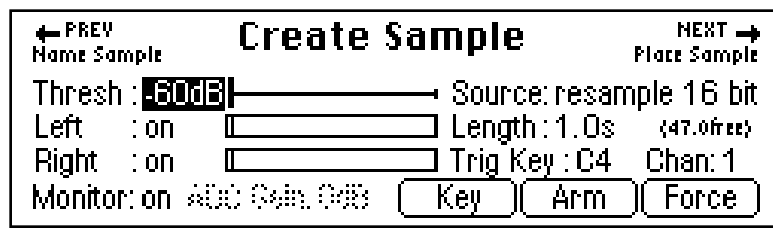

KEYBOARD SAMPLE TRIGGER

Sampling can also be initiated by playing a specified MIDI note. Sampling will continue as long as the key is held and stop when the key is released (or the selected sample length is reached). This has several applications:

- Automatic “punch-in/punch-out” using a MIDI sequencer to initiate sampling via note-on/note-off events. This makes it easy to integrate “live” vocal or guitar parts into your MIDI sequences.
- Turns the E4K into a digital multitrack recorder. Assign the lowest note to be the trigger key. Select resample. Sample length to maximum. Now press and hold the key while playing the keyboard with your left hand. Assign the sample to the trigger key, select another preset and record track two... (You have 64 or 128 tracks, depending on how many voices in the Emulator.)

► To Trigger Sampling from a Key Depression

1. Press the **Sample Manage** key. The LED will illuminate and the main screen will appear.
2. Press the **New** function key (F3). The Create Sample display will appear.
3. Move the cursor to Trig Key and select the key using the data entry control, inc/dec keys or the keyboard.
4. Move the cursor to Chan and select the MIDI Channel for the trigger key using the data entry control, or inc/dec keys.
5. Press the **Key** function key (F4) to enable Key Sample Trigger will. A pop-up dialog box will appear informing you that sampling is armed.
6. Press **Stop** or **Exit** to exit Key Sample Trigger before sampling.

AUTOMATIC PARAMETERS

After sampling, the automatic parameters screen will appear. If the sample clipped during sampling, the display will inform you at this time.

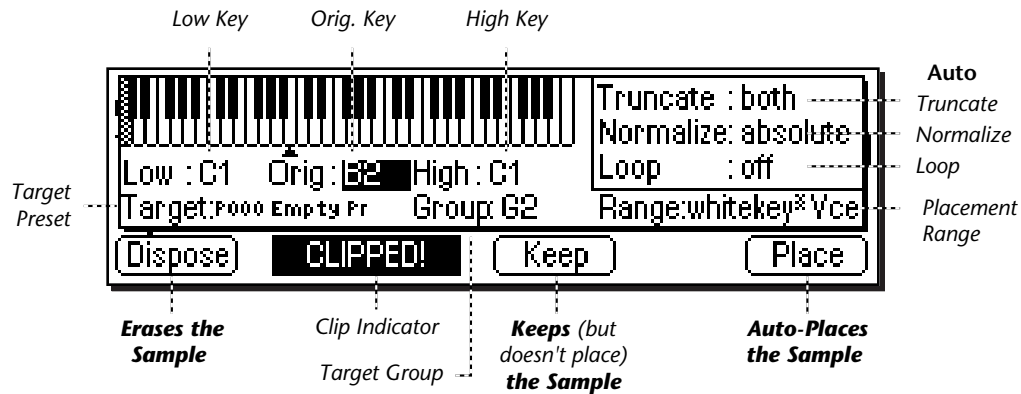

- **Dispose:** Erases the sample and returns you to the New Sample menu.
- **Keep:** Keeps the sample and performs the auto-DSP functions, but does not auto-place the sample. Returns you to the New Sample menu.
- **Place:** Keeps the sample, performs the auto-DSP functions and auto-place functions, then returns you to the New Sample menu.

The automatic DSP parameters are as follows:

- **Auto Truncate:** (Off, Start, End, Both)
Automatically truncates the start or end of the sample or both. The Zero Crossing Threshold parameter (Master, Misc.) determines the point at which truncation begins.
- **Auto Normalize:** (Off, Absolute, Relative)
Automatically increases the amplitude of a sample until the largest peak reaches 100% of full scale. Relative mode increases the amplitude of stereo samples until the largest peak of one side reaches 100%. Both sides maintain their proper amplitude relationship. Absolute mode increases the left and right samples to full level independently. Absolute and Relative have no effect when sampling in mono.



- **Auto Loop:** (Off, Whole, 1/2, 1/2 + xfd, 1/3, 1/3 + xfd, 1/4, 1/4 + xfd, 1/8, 1/8 + xfd)

This function automatically loops and autocorrelates the sample, then crossfade loops it if selected. Matching the loop length to the type of sample is important for getting the best results from auto-loop. Ensemble sounds are notoriously hard to loop and are best looped manually.

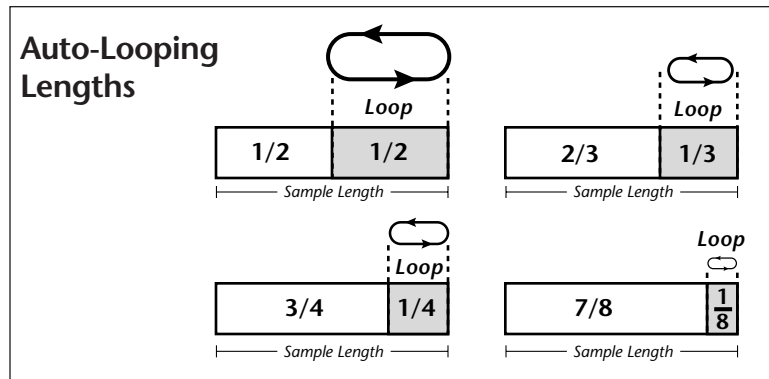

Select the auto looping length to match the type of sound. Loop on sections of the sound where the tone and amplitude are fairly static.

- Crossfade looping smoothly crossfades between the waves on either side of the loop so that the data at the loop splice points are identical. Since Crossfade looping permanently modifies the sample data, you may want to turn this feature off when doing important sampling. Auto-crossfade is a linear crossfade and sets the crossfade size to 1/2 the loop length. Experiment with auto-loop using 1/4 to 1/3 sized loops to start. In most cases, you'll find that auto-loop produces amazingly good results.

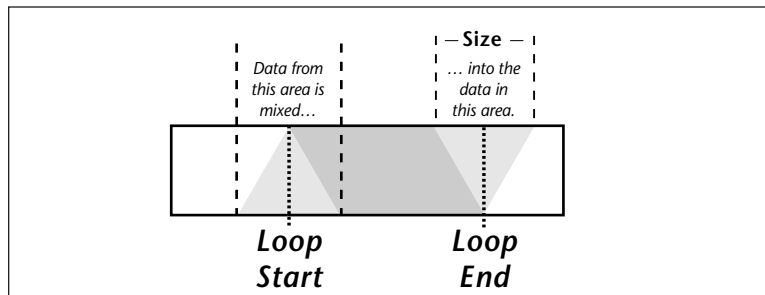

Crossfade Looping uses data from around the loop start point and crossfades this data into the area around the loop end point.

The auto-placement parameters place the sample on the keyboard.

- **Target Preset:** Selects the preset where the sample will be auto-placed.
- **Target Group:** Selects a group number for the sample.
- **Range:** Samples will be placed on the keyboard according to the selected placement range, beginning with the original key. The original key can be changed at any time to change the placement of samples.

The choices for range are:

Auto* Multisample: This function places consecutive samples into a multisample voice at the original key you select from your MIDI keyboard. As you take additional samples, the low and high keys are adjusted in order to fit the new samples onto the keyboard.

Caution: Be sure to change the target preset when resampling or you may place the sample into the same preset you are sampling from.

Tip: You can use the Expand function in the Preset Edit menu to create individual voices for each sample.

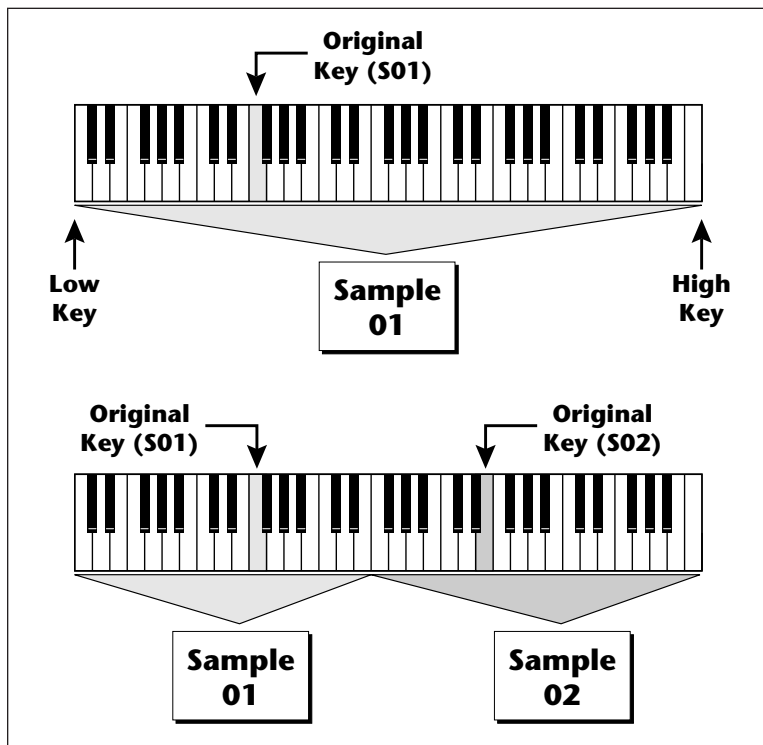

Auto Multisample: The first sample is placed over the entire keyboard. When a new sample is taken, the low and high keys are automatically adjusted to accommodate the new sample.*

Sample
Manage

You don't ever have to set the low and high keys! Simply define the original pitch and you're finished. Samples are automatically named using the name of the preset appended with the original key name (i.e. Strings C1).

White Key* Voice: A new sample will be placed on the lowest available white key beginning at the original key you select (C1 is the default starting key). Each new sample will create a new voice.

1 Key* Voice: A new sample will be placed on the lowest available white or black key beginning at the original key you select (C1 is the default starting key). Each new sample will create a new voice.

2-24 Key* Voice: New samples will be placed over a keyboard range consisting of the number of keys selected. You can select the starting key by manually setting the original key (C1 is the default starting key). Each new sample will create a new voice.

► To Create an Auto-Multisample:

This function works especially well for sampling other synthesizers.

1. Press the **Sample Manage** key. The LED will illuminate and the main screen will appear.
2. Press the **New** function key (F3). The Create Sample display will appear.
3. Set up the sampling parameters such as sample length, sample source and take the sample. The auto-placement screen will appear.
4. Press the original key on your MIDI keyboard.
5. Set Truncate to **Both**, Normalize to **Relative**, Loop to **1/4 + xfade**. Set Range to **auto* Multisample**. Set the target preset to an empty location.
6. Press **Place**. The E4K asks you to name the preset (if it was empty). Name the preset and press **OK**.
7. The E4K will perform the DSP functions, then auto-place the sample.
8. If you wish to take additional samples do so now. Simply define the original key using your MIDI keyboard then press **Place** after taking each sample.

Place Sample

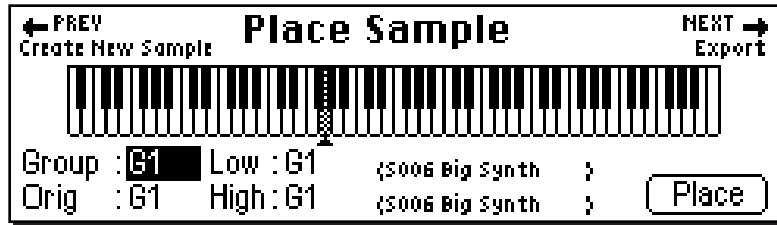

After sampling, a sample is automatically assigned to its own voice. This function allows you to place the voice (and the sample) onto a range of the keyboard without leaving the Sample Manage module.

► To Place a Sample:

1. Press the **Sample Manage** key. The LED will illuminate and the main screen will appear.
2. Select the sample to be placed using the data entry control, inc/dec keys, or the numeric keypad.
3. Press the **Place** function key (F4). The screen shown above will appear.
4. The sample can also be assigned a group number at this stage as a convenience. Use the data entry control or inc/dec keys to change the group number if desired.
5. Set the Original key and the High and Low keys for the voice. Use the Cursor keys or function keys to select the parameter and the inc/dec keys, your MIDI keyboard or the data entry control to change the key range.
6. Press **Place** to confirm placement or **Exit** to cancel the operation.



Export Sample



Tip: To save all the samples in a bank in EIIIx format, press and hold the decimal point key while you press the Save softkey. The display will offer you the option to save in EIIIx format.

[as EIIIx as EIV]

Note that the preset information is NOT transferred, only the samples.

This function allows you to export a single sample as a self-contained bank in either Emulator IV or EIIIx format.

Suppose you were experimenting and modified a sample using the sample edit module. The sample data is permanently changed. You want to keep the modified sample, but if you save the bank, the original sample will be lost. Using this function, you can export the modified sample to a new bank and have both!

► To Export a Sample:

1. Press the **Sample Manage** key. The LED will illuminate and the main screen will appear.
2. Select the sample to be exported using the data entry control, inc/dec keys, or the numeric keypad.
3. Press the **Export** function key (F5). The screen shown above will appear.
4. Select the destination drive, folder and bank using the cursor keys and data entry control. You cannot write into an existing bank without erasing it. Usually you will choose an empty bank.
5. Select either EIV or EIIIx format for the samples. Press **F3** for EIIIx or **F4** for E4K format.
6. Press **OK** to export the sample or **Cancel** to cancel the operation.

**Sample
Manage**

Get Info

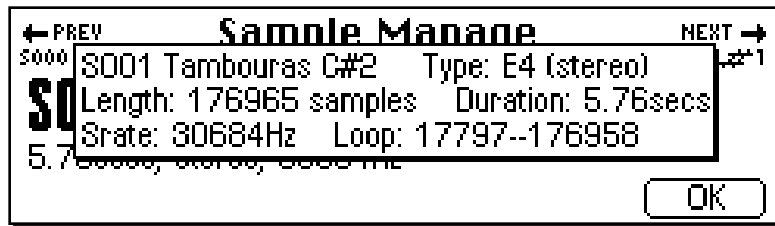

This function displays a sample's size in number of samples and length in seconds. It also lists the amount of memory remaining.

► To Get Information about a Sample:

1. Press the **Sample Manage** key. The LED will illuminate and the main screen will appear.
2. Select the desired sample using the data entry control, inc/dec keys, or the numeric keypad.
3. Press the **Info...** function key (F6). A pop-up window appears with information about the sample.
4. Press the **OK** function key to return to the main Sample Manage screen.



Sample Edit

Background	181
Utilities	190
<i>Cut Section</i>	191
<i>Copy Section</i>	193
<i>Paste Section</i>	194
<i>DC Filter</i>	198
<i>Sample Calculator</i>	199
<i>Sample Integrity</i>	200
Loop Type	201
Tools 1	203
<i>Loop</i>	203
<i>Truncation</i>	206
<i>Taper</i>	207
<i>Gain Change</i>	209
<i>Stereo <-> Mono</i>	211
<i>Swap Left <-> Right</i>	211
Tools 2	212
<i>Sample Rate Convert</i>	212
<i>Digital Tuning</i>	214
<i>Compressor</i>	215
<i>Parametric EQ</i>	220
<i>Reverse Section</i>	222
Tools 3	223
<i>Time Compression</i>	224
<i>Pitch Change</i>	225
<i>Transform Multiplication</i>	226
<i>Doppler</i>	227
<i>Exciter</i>	230
Undo	231

SAMPLE EDIT



The Sample Edit menu allows you to modify the actual sample data in order to perform functions such as: sample looping, sample truncation and splicing, equalization, time compression, sample rate conversion and many others. In the sample edit module we are working with the most basic element of the E4K hierarchy, the sample. It is important to note that every one of these functions except basic looping PERMANENTLY modifies the sample data.

The Sample Manage menu contains six main submenus:

- **Utilities** - Cut, Copy, Paste, DC Filter, Sample Calculator Sample Integrity.
- **Loop Type** - Turns Looping and Loop in Release On or Off.
- **Tools 1** - Looping controls, Truncation, Taper, Gain, Stereo<->Mono conversion, Swap Left and Right channels.
- **Tools 2** - Sample Rate Conversion, Digital Tuning, Compressor, Parametric EQ, Reverse Sample.
- **Tools 3** - Time Compression, Pitch Change, Transform Multiplication, Doppler/Pan, Exciter.
- **Undo** - Allows you to undo any sample editing process.

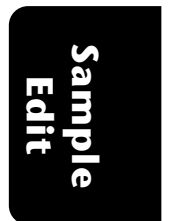

BACKGROUND: About Looping

Sampling is the process of storing sounds in digital memory. Since each individual sample (not the complete sample, but each element of the sample) requires one memory slot, memory requirements increase if you sample long sounds or use high sampling rates.

How Looping Works

Looping is a technique that can extend a sound's length without using lots of memory. It is based on the fact that many sounds start off with a complex attack transient, then settle down to a comparatively steady sound. Listen carefully to a plucked guitar string. The first part of the sound consists of a complex mixture of pick noise and several harmonics; after a while, the string decays down to a pretty steady repetitive waveform.

Since the latter part of the waveform is repetitive, there is no need to waste memory sampling several seconds of it. Instead, you can mark off a loop of the repetitive section, and instruct the E4K to play that looped section for as long as the key is held down. After playing to the end of the loop, the E4K will jump back to the beginning of the loop and play through the loop again. This process repeats until you release the key playing back the sample.

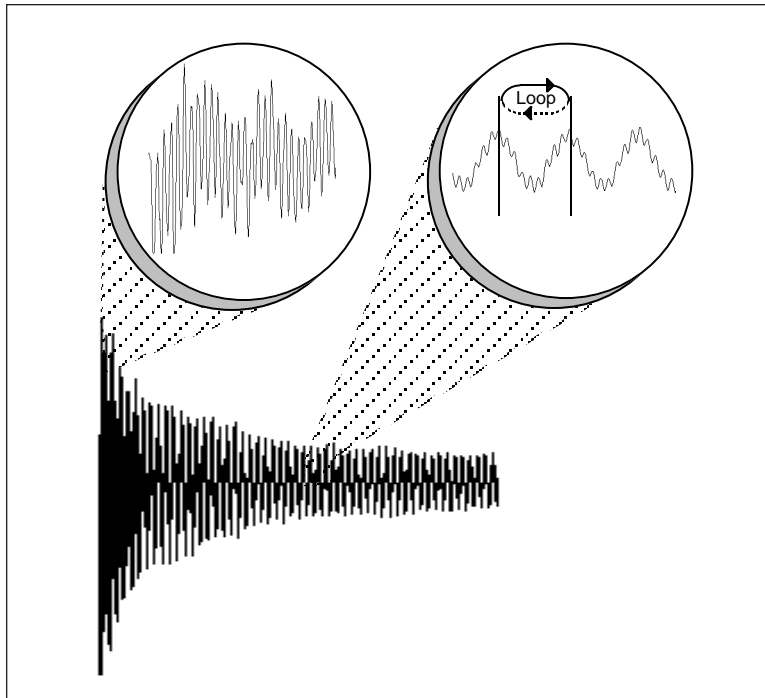

Creating Attack & Decay Characteristics for the Looped Portion

One potential problem is that the loop repeats at the same level. This is usually acceptable for sustaining instruments (flute, organ, brass, etc.), but is unacceptable for plucked or struck sounds, which decay over time. Fortunately, the Dynamic Processing module provides a means to shape the attack, sustain, and decay characteristics of a sample. You can create a decay during the looped portion, and simulate pluck or struck sounds.

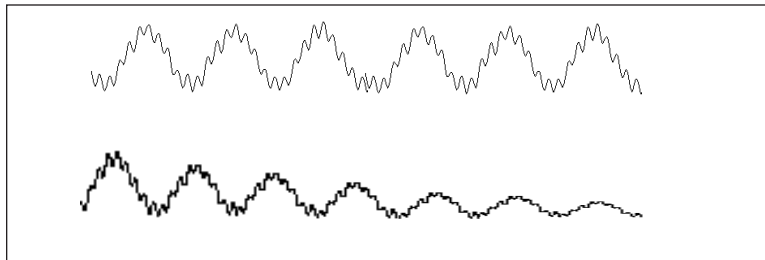

Artificial Decay can be applied to a looped sound.

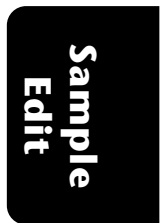

Loop Compression

The looped section of the sample can be compressed, which “evens out” any changes in amplitude. Changes in amplitude can cause “breathing” effects, thumping or clicks.

Crossfade Looping

The E4K fades between the beginning and end of the loop so that as the end fades out, the beginning fades in. This virtually eliminates the clicks and pops that can occur with other types of looping.

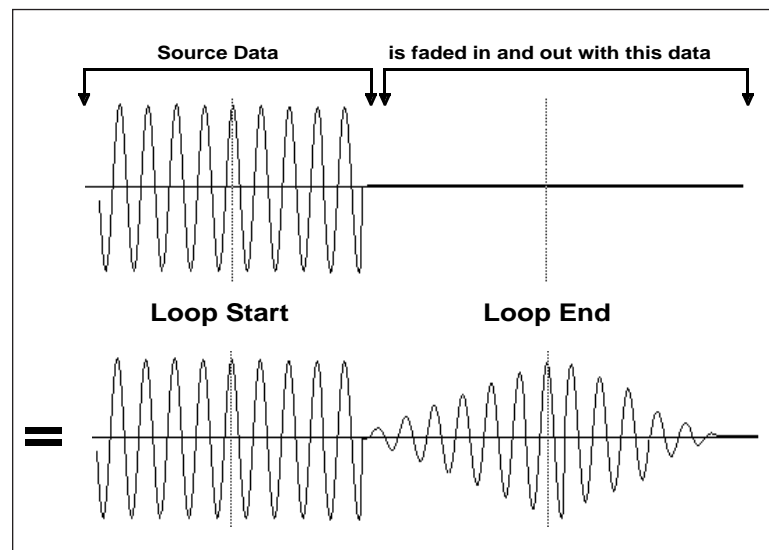

Crossfade Looping takes sound data from around the loop start point and fades it into the sound data around the loop end point so that the data at those loop points is identical.

BACKGROUND: Cut, Copy, Paste & Undo

Imagine a printout of a sample. Now imagine that you have a pair of scissors capable of cutting a piece out of that sample (or a copy of that piece if you don't want to affect the original), as well as a clipboard to neatly hold the cut or copied piece. Now imagine that you can either perfectly insert the clipboard contents at any given point in any sample, *or* mix the clipboard contents in with any sample, starting at any designated point. The E4K can do all this, and all electronically. The E4K also provides Auto Correlation and Crossfade functions that result in seamless transitions between the cut, copied, and pasted parts.

Tip: The clipboard contents are designated as Sample 000.

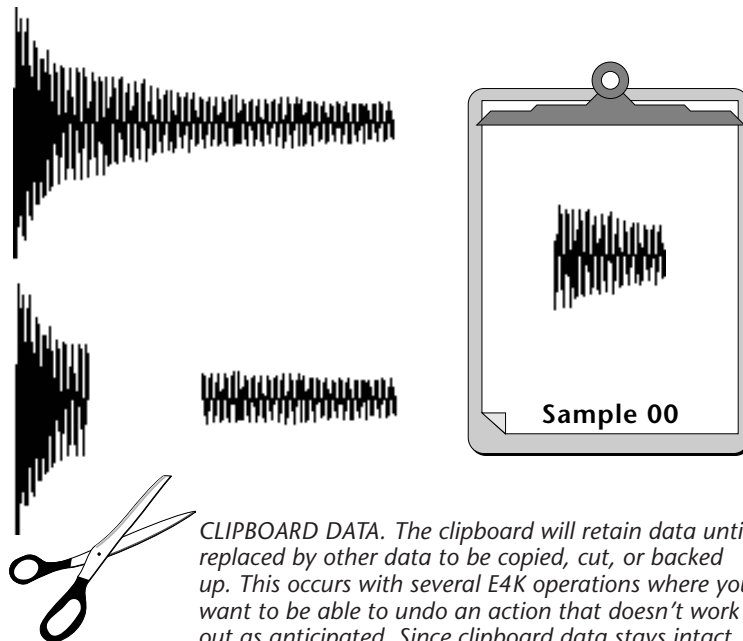

CLIPBOARD DATA. The clipboard will retain data until replaced by other data to be copied, cut, or backed up. This occurs with several E4K operations where you want to be able to undo an action that doesn't work out as anticipated. Since clipboard data stays intact when you call up another sample, data can be cut or copied from one sample and pasted to another.

**Sample
Edit**

 **Caution:** *Undo and Redo cannot backup to a floppy disk drive. A hard disk drive must be connected.*

Undo and Redo

During several E4K sample edit operations such as cut, paste, and sample rate conversion, the E4K will automatically back up the sample being processed and store this backup on the main hard disk drive. If you do not like the results of the processing, you can call up the Undo function, and restore the original sample from the main drive. (Ah, if only life itself were so simple.) Best of all, the processed sample will now move onto the main drive. Thus, if you decide you liked the processed version better after all, you can actually undo the undo. (Redo.)

Insufficient Hard Disk Drive Memory

The display will inform you if there is not enough memory to back up a sample onto the hard disk drive. You then have two choices: either free up some additional memory by erasing banks on the hard disk drive, or call up the Undo function and disable the backup process. Of course, if backup is disabled, you will not be able to undo an operation.

Typical Applications

Typical cut/copy/paste applications would be to splice the beginning of one sample to the end of another, or to mix two samples together to conserve memory. (Do this by copying an entire sample, then pasting it at the beginning of the second sample using the mix option.) You can splice an attack transient on to a synthesizer waveform loop to produce realistic sounds that take up virtually no memory, or take out a pop or click in a sample. Another possibility is for flanging and chorusing. Paste (mix) a sample to itself, offset from the beginning by a few hundred samples or so, to thicken up the sound.

We suggest you practice cut, copy, and paste techniques on a spoken phrase. Samples of political speeches can be particularly amusing when subjected to cut and paste operations.

BACKGROUND: The Scrub Wheel

The Scrub Wheel is an E4K function that allows you to use the pitch wheel in many Sample Edit functions to quickly move through a sound, similar in concept to rocking the reels of a reel-to-reel tape recorder. The scrub wheel makes it easy to locate a particular section of a sound because you are able to hear the sound as you move through it.

To use the scrub wheel, move the pitch wheel of your MIDI keyboard while in a Sample Edit function such as Truncation or Looping. If the pitch wheel is moved slightly forward, the sound will play slowly through its length. If the wheel is pushed forward all the way, the sound will play through faster. If the wheel is moved backwards (towards you) the sound will play backwards through the sound. The scrub wheel operates like the accelerator on your car: the harder you press it, the faster it goes.

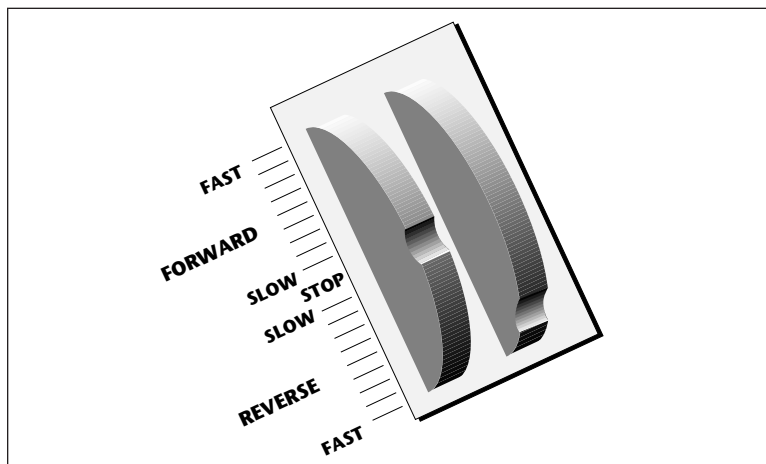

E4K SCRUB WHEEL. Move the wheel slightly to advance slowly through the sound. Move the wheel more to advance quickly through the sound.



BACKGROUND: Autocorrelation & Zero-Crossing

Auto Correlation

First of all, just what does auto correlation mean? Auto correlation simply means automatic correlation or comparison. The computer analyzes the signal around the loop points you have specified and then moves the end point of the loop until it finds a section of the wave that closely matches the section around the start point. Auto correlation may be used again and again with the computer moving the analysis window slightly each time to try to zero in on the optimum loop.

Zero Crossing

The term zero crossing refers to the point at which the positive slope of a waveform passes through zero. In many sample editing applications, such as splicing and looping, it is useful to locate zero crossings in order to make glitch-free joins and loops. On some signals, however, a simple zero crossing may not be effective because the signal contains excessive noise or low-level, high-frequency harmonics. In these cases, every few samples may cross through zero. By setting a zero crossing threshold, we can ignore low-level zero crossings and wait for the signal to reach a certain level before choosing the next zero-crossing. Zero crossing threshold sets a level that a signal must exceed before the next zero crossing with a positive slope is selected. The selected zero crossing threshold is used in the Auto-Truncate function or whenever you manually select a zero crossing using the cursor keys.

The diagram on the following page illustrates zero crossing in action. The small x marks the initial position. To move forward through the sound to the next zero crossing, press the right cursor button, as shown in the upper dia-

gram. The E4K will find the first zero crossing on the positive slope after the signal has crossed the designated threshold.

To move backward through the sound to the next zero crossing, as shown in the lower diagram, press the left cursor button. The E4K will find the first zero crossing on the positive slope after the signal has crossed the designated threshold.

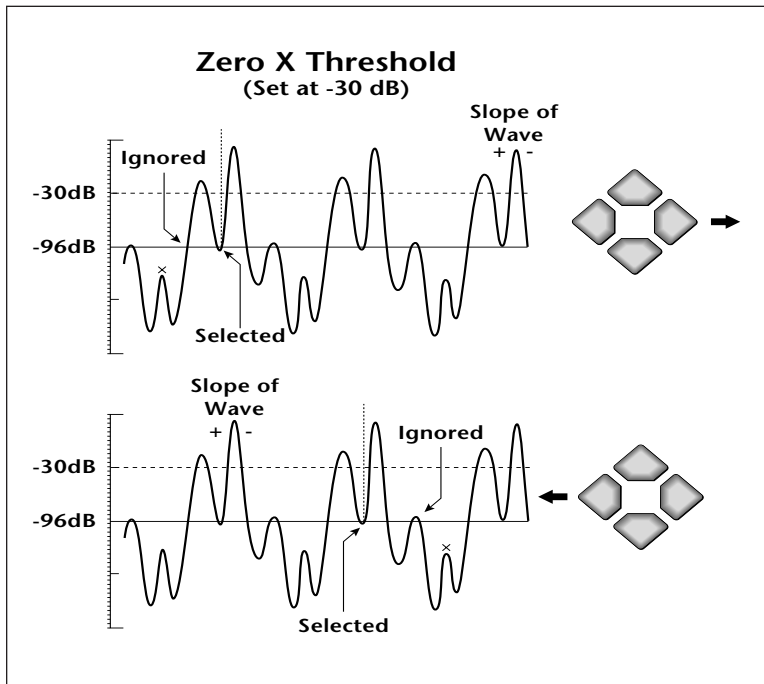

Adjust the zero crossing threshold according to the type of wave you are processing. A setting of -96 dB is most sensitive and can be used for finding the start point of a sound. Settings closer to -30 dB are less sensitive and suited for finding zero-crossings in complex waves.

Utilities

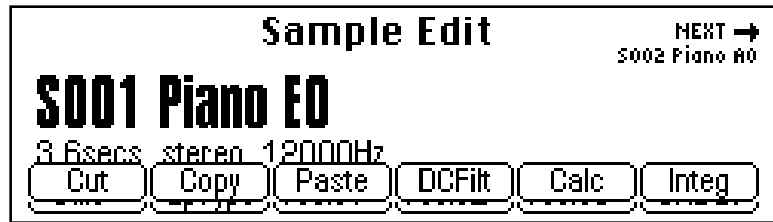

The Sample Utilities menu contains several additional functions.

- Cut Section
- Copy Section
- Paste Section
- DC Filter
- Sample Calculator
- Sample Integrity

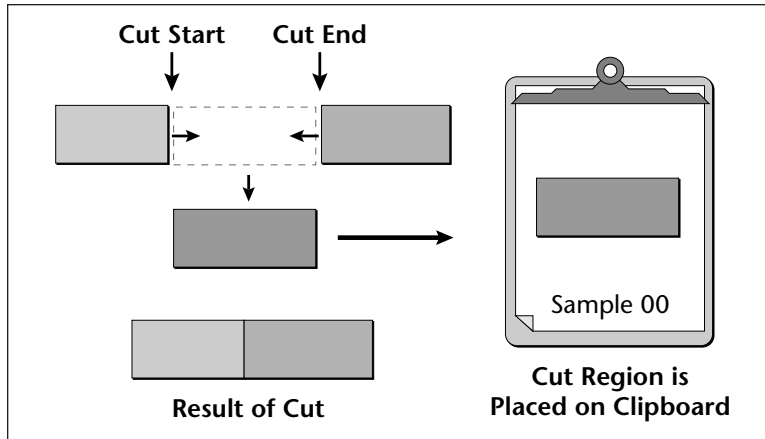

Tip: The clipboard contents are designated as Sample 000.

CUT SECTION

Portions of a sample can be cut, copied, and pasted to other samples, or the samples from which they came. The Cut function removes a section of a sample, and stores the cut portion in a special part of memory called the clipboard. For more information see the section Background: Cut, Copy, Paste, and Undo.

► To Cut a Section:

1. Press the **Sample Edit** key. The LED will illuminate and the main sample edit screen will appear.
2. Select the sample to be cut using the data entry control, inc/dec keys, or the numeric keypad.
3. Press the **Utils** function key (F1). A second row of soft keys will appear.

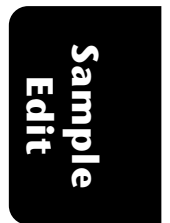

4. Press the **Cut** function key (F1). The following screen will appear. (If the sample is stereo, you will first be asked to select the right side, left side or both.)

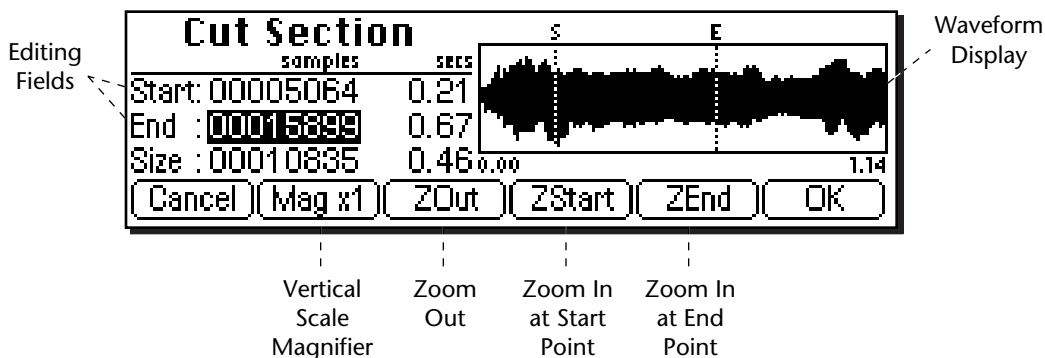

Tip: Holding down the Enter key while turning the data entry control allows “fine tuning” of the value by one number per click.

Tip: The left and right cursor keys will change the start and end points so that they automatically fall on positive zero-crossing points in the waveform.

A visual display of the waveform appears with several controls.

- **Editing Fields:** Move the cursor to the desired field to change the Start and End points of the cut.
- **Magnification:** Adjusts the vertical scale for 1x, 2x, 4x, or 8x magnification. Pressing the button repeatedly rotates through the 4 options.
- **Zoom Start:** Magnifies the waveform to display finer detail around the Start point.
- **Zoom End:** Magnifies the waveform to display finer detail around the End point.
- **Zoom Out:** Reverses the effect of Zoom Start and Zoom End.

5. Specify the start and end points for the portion of the sample to be cut.
6. Press **OK** to cut the section or **Cancel** to return to the main Sample Edit screen.
7. If you are not happy with the resulting cut or want to compare before and after, press the **Undo** function key (F6).

COPY SECTION

Portions of a sample can be cut, copied, and pasted to other samples, or the samples from which they came. The Copy function allows you to duplicate a section of a sample, and store that duplicate in a special part of memory called the clipboard. For more information see the section Background: Cut, Copy, Paste, and Undo.

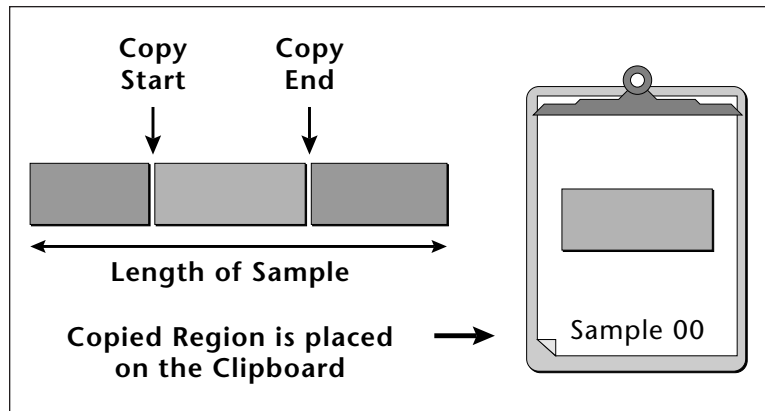

Tip: The clipboard contents are designated as Sample 00.

► To Copy a Section:

1. Press the **Sample Edit** key. The LED will illuminate and the main sample edit screen will appear.
 2. Select the sample to be copied using the data entry control, inc/dec keys, or the numeric keypad.
 3. Press the **Utils** function key (F1). A second row of soft keys will appear.
 4. Press the **Copy** function key (F2). The Copy Section screen will appear. (If the sample is stereo, you will first be asked to select the right side, left side or both.)
- The Copy Section display is identical to the display in Cut Section. See Cut Section for a full description of the controls.
5. Specify the Start and End points for the portion of the sample to be copied using the data entry control, left/right cursor keys, inc/dec keys or the numeric keypad.
 6. Press **OK** to cut the section or **Cancel** to return to the main Sample Edit screen.

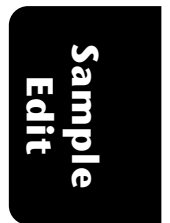

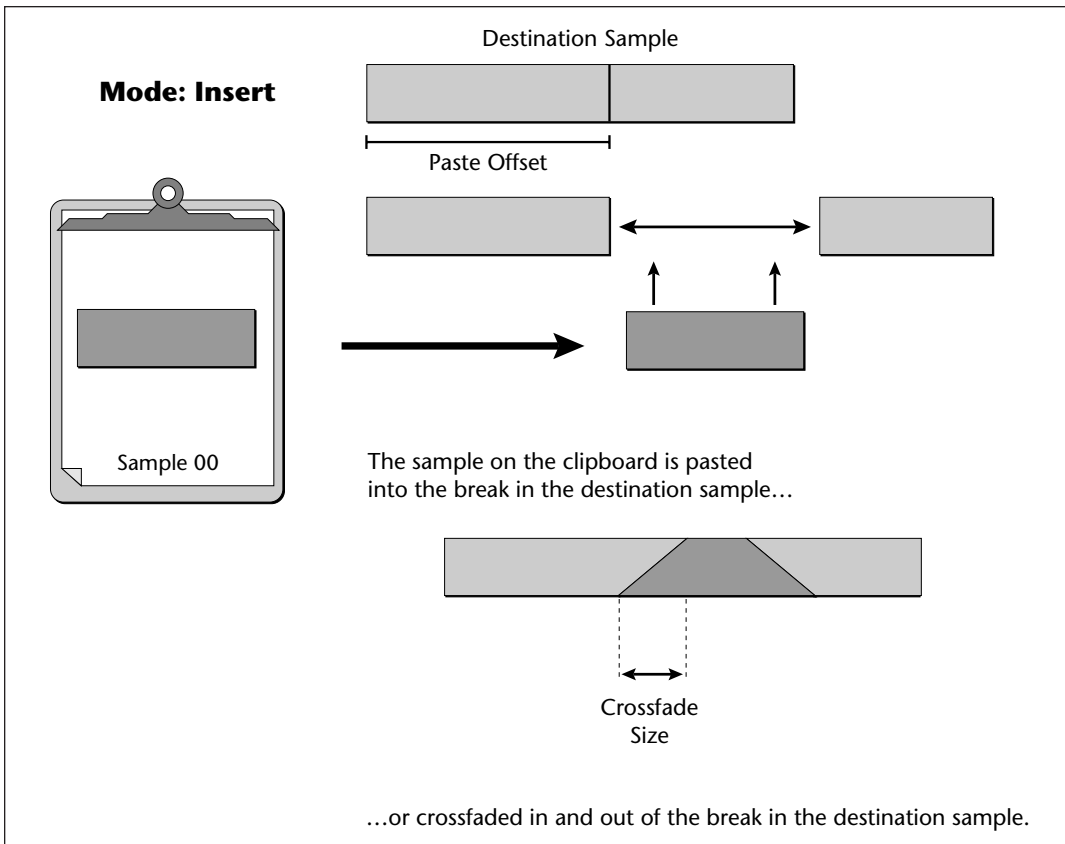

PASTE SECTION

Portions of a sample can be cut, copied, and pasted to other samples, or the samples from which they came. Paste takes the clipboard contents and either inserts them in a sample at a specified point, or mixes them with a sample starting at a specified point. For more information see the section Background: Cut, Copy, Paste, and Undo.

► **To Paste a Section:**

1. Press the **Sample Edit** key. The LED will illuminate and the main sample edit screen will appear.
2. Select the sample that you want to paste the clipboard contents into using the data entry control, inc/dec keys, or the numeric keypad.
3. Press the **Utils** function key (F1). A second row of soft keys will appear.
4. Press the **Paste** function key (F3). If the sample is stereo, you will first be asked to select the right side, left side or both. The following screen will appear.

Tip: Holding down the Enter key while turning the data entry control allows “fine tuning” of the value by one number per click.

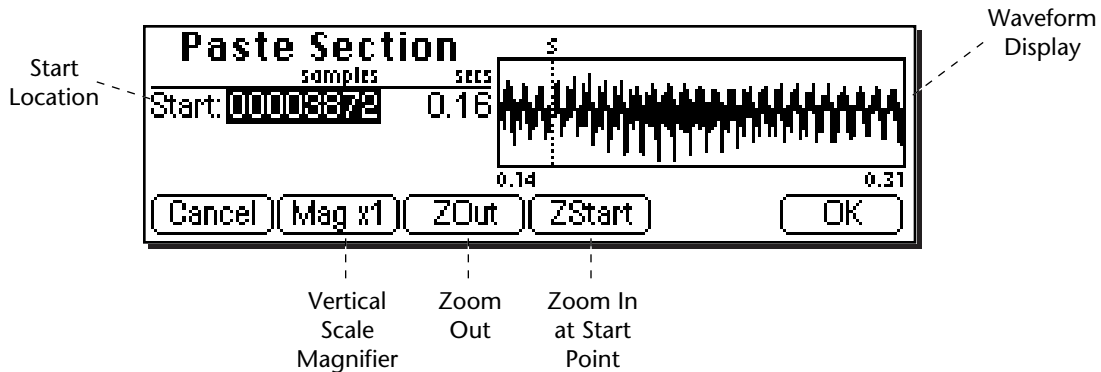

A visual display of the waveform appears with several controls.

- **Start Location:** Selects the starting location where the clipboard sample will be pasted.
- **Magnification:** Adjusts the vertical scale for 1x, 2x, 4x, or 8x magnification. Pressing the button repeatedly rotates through the 4 options.
- **Zoom Start:** Magnifies the waveform to display finer detail around the Start point.
- **Zoom Out:** Reverses the effect of Zoom Start.

Tip: The left and right cursor keys will change the start and end points so that they automatically fall on positive zero-crossing points in the waveform.

5. Specify the start point for the clipboard sample to be pasted into, then press **OK**. The following screen will appear.





6. Choose whether to insert or mix the clipboard contents at the point selected in step 5.

Insert opens up a space in the sample into which the clipboard contents fit. **Equal Power Mix** and **Linear Mix** combine the clipboard contents with existing samples, starting at the point selected in step three. Normally, you will always use Equal Power. Use Linear Mix when the signals are very similar or when Equal Power causes a gain in amplitude.

7. Set the Crossfade Size and Type.

- **Equal Power:** This is a weighted crossfade that produces no apparent level shift. You will normally use this mode.
- **Linear:** This provides a straight mathematical crossfade.

8. If you chose Linear or Equal Power Mix in step 6, another field in the display will appear.

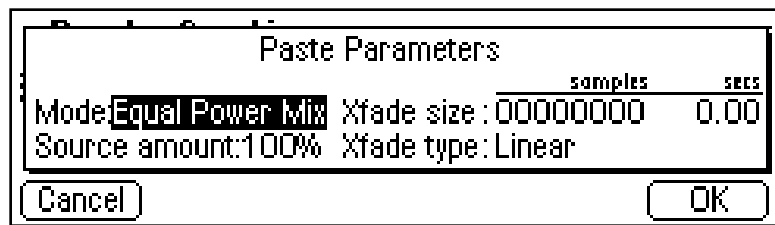

9. You have the option to select the level of the clipboard contents to be mixed (**Source Amount**). 100% indicates a replacement. Refer to the diagrams on the following page.

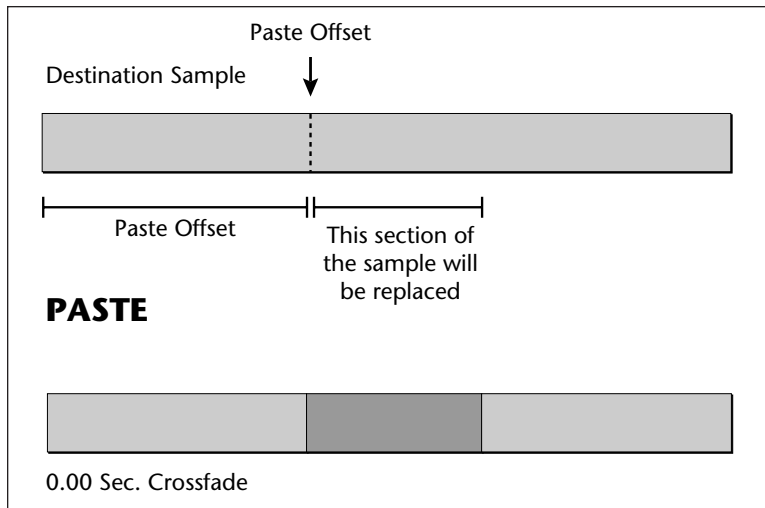

Mode: Mix **Source Amount = 100%**
 After the start point, a section of the destination will be replaced with the clipboard contents.

Tip: To replace one side of a stereo sample: Mix the clipboard with a source amount of 100% into the side you wish to replace.

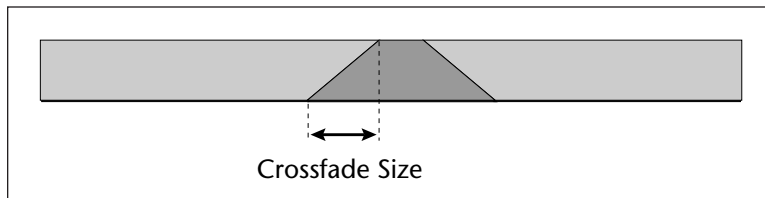

Mode: Xfade Mix **Source Amount = 100%**
 The clipboard contents will be gradually mixed into the destination sample and will replace the destination when the fade reaches 100%.

Note: If you are not happy with the resulting paste or want to compare before and after, press the Undo function key (F6).

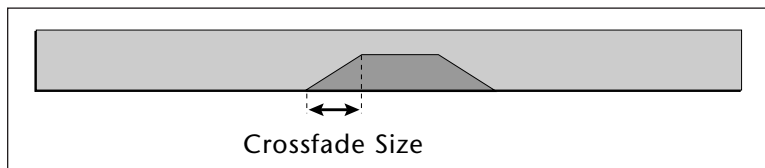

Mode: Xfade Mix **Source Amount = 50%**
 The clipboard contents will be gradually mixed into the destination sample and reach a maximum of 50-50 mix.

8. Press **OK** to paste the section or **Cancel** to return to the main Sample Edit screen.



DC FILTER

Removes the DC component from a sample, centering the waveform around the zero axis.

► To DC Filter:

1. Press the **Sample Edit** key. The LED will illuminate and the main sample edit screen will appear.
2. Select the sample that you want to DC Filter using the data entry control, inc/dec keys, or the numeric keypad.
3. Press the **Utils** function key (F1). A second row of soft keys will appear.
4. Press the **DC Filter** function key (F4). The following screen will appear.

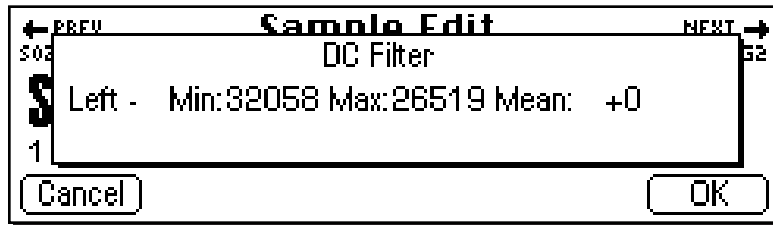

★ Caution: If the sample sounds clipped after DC Filtering, Undo, then attenuate the sample by 2 dB. Next, DC Filter the sample and Normalize using Change Gain.

The positive and negative peaks of the sample are expressed in 16 bit samples. Full scale for a 16-bit sample is ± 32767 . Use the peak values to see how close you are to full scale. If one of the peaks is too close to 32767, DC Filtering may cause the signal to clip. **Mean** is the DC bias present in the sample. The lower the number, the less bias is present.

5. Press **OK** to DC Filter or **Cancel** to cancel the operation.

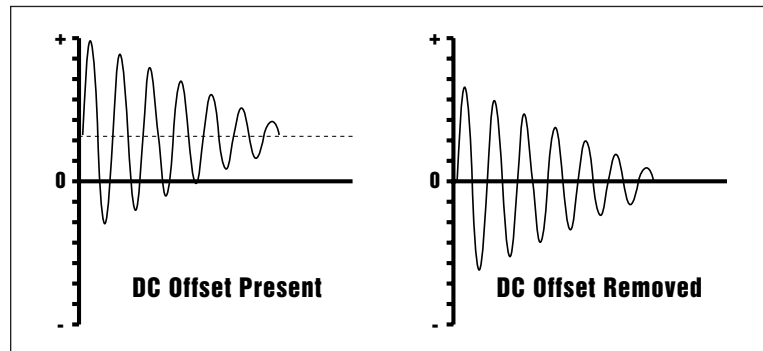

Sample Edit

SAMPLE CALCULATOR

Use the sample calculator to compute sample rates for perfect single cycle loops.

► To Use the Sample Calculator:

1. Press the **Sample Edit** key. The LED will illuminate and the main sample edit screen will appear.
2. Press the **Utils** function key (F1). A second row of soft keys will appear.
3. Press the **Calc** function key (F5). The following screen will appear.

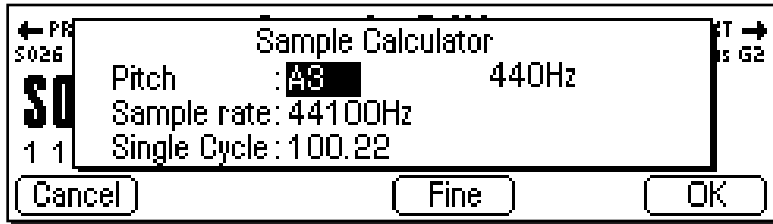

4. Select the pitch using the keyboard, inc/dec keys or the data entry control. The number of samples for a single-cycle loop changes for each note.
 5. Select the sample rate using the inc/dec keys or the data entry control. The number of samples for a single-cycle loop changes for each sample rate.
- **Coarse/Fine** - Fast forward through the values using Coarse, then switch to Fine for single digit editing.
 - **Frequency Indicator** - Displays the fundamental frequency of the selected note.
 - If the single-cycle value shown is not an integer number, adjust the sample rate value so that it does become an integer number, then use the Sample Rate Convert function to convert the sample to the new rate.
6. Press **OK** or **Cancel** to return to the Sample Edit screen.

Sample
Edit

SAMPLE INTEGRITY

Imported samples may occasionally have slight looping problems (heard as ticks) due to data corruption of the sample header file. This function remedies the problem by reconstructing the sample header.

► To Fix all Samples:

1. Press the **Sample Edit** key. The LED will illuminate and the main sample edit screen will appear.
2. Press the **Utils** function key (F1). A second row of soft keys will appear.
4. Press the **Integ** function key (F6). The display will ask if you want to, "Fix all Samples?".
5. Press **OK** to fix all samples in the bank or **Cancel** to return to the Sample Edit screen.

**Sample
Edit**

Loop Type

This submenu allows you to turn looping On or Off and to select whether the Loop in Release function is On or Off.

► To Set the Loop Type

1. Press the **Sample Edit** key. The LED will illuminate and the main sample edit screen will appear.
2. Press the **LpType** function key (F2). The following screen will appear.

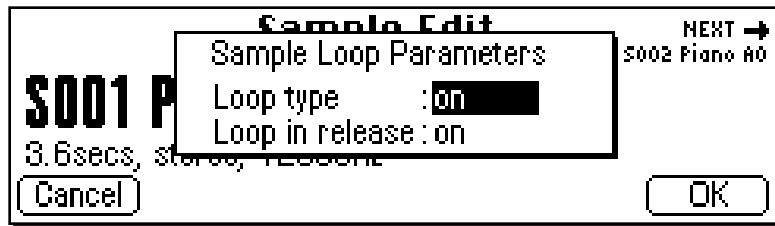

3. Select Loop Type as either On or Off.
 - **Off:** The loop is disabled and the sample plays as recorded.
 - **On:** The sample plays normally until it reaches the end of the loop. It then jumps back to the start point and replays through the loop. Upon reaching the loop end, it again replays the loop. This looping process continues for as long as the key is pressed.
4. Select whether Loop in Release is On or Off.

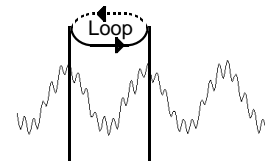

★ Caution: Samples imported from the E111 having forwards/backwards loops will play back on the E4K. However, the loop data will be permanently modified to contain the forwards/backwards sound data. Changing the loop points on imported forwards/backwards loops could have unpredictable results and is not recommended.

**Sample
Edit**

- **Off:** Lifting your finger off a key initiates the release phase of the amplifier envelope in the voice. If Loop in Release is off, the loop will not continue during the release phase. The portion of the sample after the loop will be played during release. The signal may cut off abruptly after you remove your fingers from the keys if the sample has been truncated after the loop.
 - **On:** With Loop in Release on, the loop will keep playing—even after you lift your finger off the key—for the duration of the amplifier envelope release.
5. Press **OK** to enter the new values or **Cancel** to cancel your changes.

Tools 1

This submodule contains the basic digital processing tools listed below.

- **Looping**
- **Truncation**
- **Taper**
- **Gain Change**
- **Stereo to Mono Conversion**
- **Swap Left <-> Right**

LOOP

If you have a difficult time finding good loop points, the E4K can assist you with the Auto Correlation function. If Auto Correlation doesn't produce acceptable results, the beginning and end of a loop can be crossfaded to help mask loop discontinuities. For more information, see Background: About Looping at the beginning of this section.

► To Set the Loop Points

1. Press the **Sample Edit** key. The LED will illuminate and the main sample edit screen will appear.
2. Select the sample that you want to loop using the data entry control, inc/dec keys, or the numeric keypad.
3. Press the **Tools 1** function key (F3). Another row of soft keys will appear.
4. Press the **Loop** function key (F1). The following screen will appear.



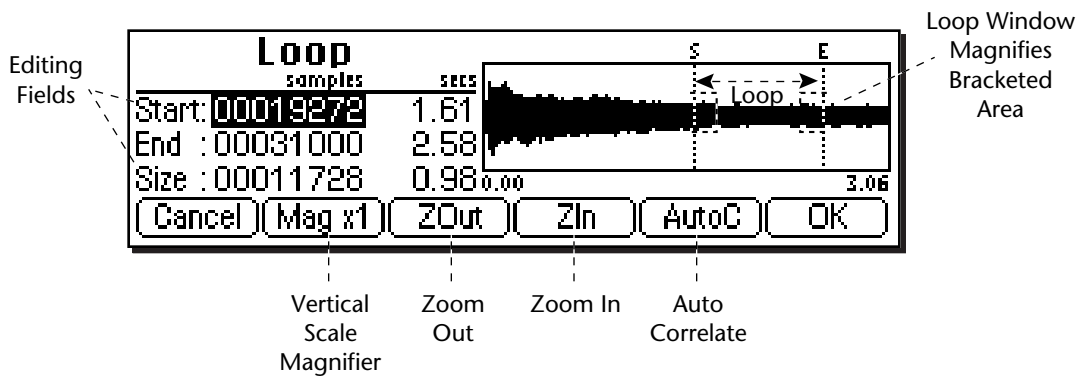

Tip: Holding down the Enter key while turning the data entry control allows “fine tuning” of the value by one number per click.

Caution: You cannot Undo loop points.

A visual display of the waveform appears with several controls.

- **Editing Fields:** Move the cursor to the desired field to change the Start and Size of the loop. The Loop Start and Size parameters are interrelated, i.e. adjust the size value if you are not able to move the start point where you wish and vice-versa.
- **Magnification:** Adjusts the vertical scale for 1x, 2x, 4x, or 8x magnification. Pressing the button repeatedly rotates through the 4 options.
- **Auto Correlate:** Allows the E4K to analyze the waveform and find likely loop points.
- **Zoom In:** Magnifies the waveform to display fine detail and brings up the loop window.
- **Zoom Out:** Reverses the effect of Zoom In and displays the entire sample.

When you **Zoom In** on the waveform, the **Loop Window** appears. The loop window magnifies the splice point of the loop as shown by the bracketed area in the diagrams below.

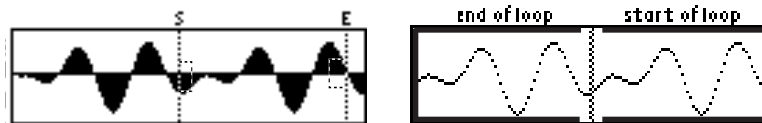

The line in the center of the magnified loop window shows the exact splice point of the loop. You can use the left and right cursor keys to select zero-crossings for the loop start.

Sample Edit

- Press the **Auto Correlate** soft key (F5) if you want the E4K to help you find likely loop points.
- Press **OK** when you have a good loop. The following screen will appear with several more looping tools.

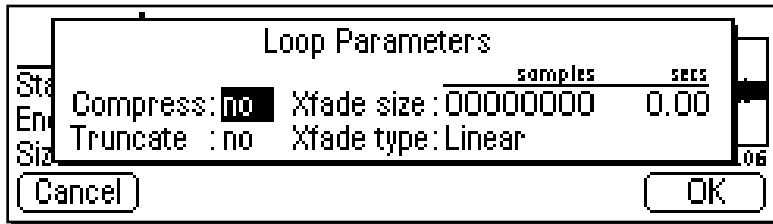

Tip: Looping is an art which takes a bit of practice to learn. Auto Correlate works best when you have already found a fairly good loop point by ear. The E4K provides several different types of tools to help you loop almost any sound.

- Compress Loop:** Compression “evens out” the level changes during the loop portion which are perceived as amplitude modulation or “breathing” effects.
- Truncate:** (After Loop) Discards any information after the loop end point in order to conserve memory.
- Crossfade Size:** (Crossfade Loop) This function smoothly crossfades between the waves on either side of the loop so that the waveform at the loop point is identical. Crossfading looping is a powerful looping tool, but since it alters the sound data, timbral or amplitude variations may be noticeable. A size of 0.00 disables crossfade looping.

Tip: Use larger crossfade loop sizes with complex sounds; shorter sizes when you simply want to mask a slight tick in the loop.

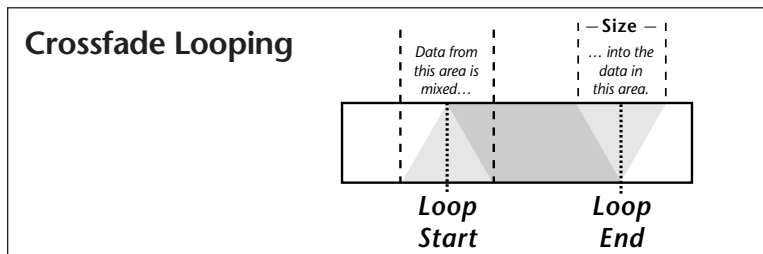

- Crossfade Type - Equal Power:** This is a weighted crossfade that produces no apparent level shift, and is the commonly used mode.
 - Crossfade Type - Linear:** This provides a straight mathematical crossfade. Use linear mode with samples whose splice points are already close to optimum, such as a sample that has already been auto correlated.
- Press **OK** to perform the operations or continue. Press **Cancel** to cancel the loop operation.

Sample Edit

TRUNCATION

Truncation shortens a sample's length by trimming off individual samples from the beginning and/or end. Truncation is most often used to remove unneeded portions of a sample to conserve memory, but it can also be used to change instrument characteristics such as removing the attack from a plucked string note or isolating a particular section of a sample.

► To Truncate a Sample:

1. Press the **Sample Edit** key. The LED will illuminate and the sample edit screen will appear. Select the sample.
2. Press the **Tools 1** function key (F3). Another row of soft function keys will appear.
3. Press the **Truncate** function key (F2). The following screen will appear.

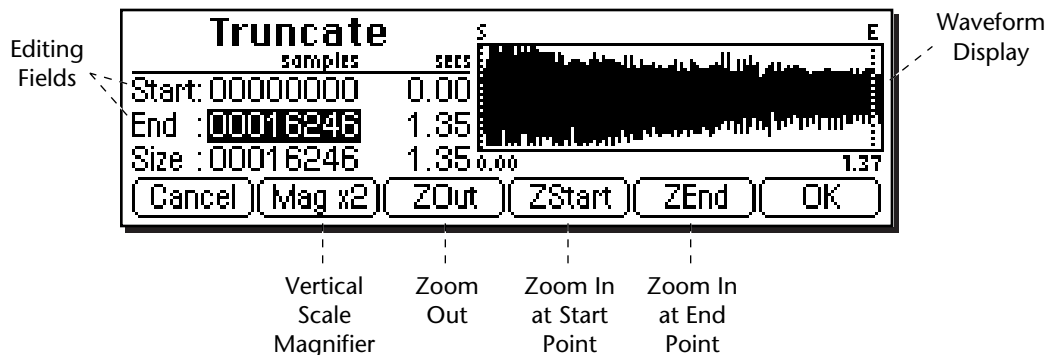

Tip: Holding down the Enter key while turning the data entry control allows "fine tuning" of the value by one number per click.

Sample Edit

- **Editing Fields:** Move the cursor to the desired field to truncate the Start and End points of the sample.
- **Magnification:** Adjusts the vertical scale for 1x, 2x, 4x, or 8x magnification. Pressing the button repeatedly rotates through the 4 options.
- **Zoom Start:** Magnifies the sample to display finer detail around the Start point.
- **Zoom End:** Magnifies the sample to display finer detail around the End point.
- **Zoom Out:** Reverses the effect of Zoom Start and Zoom End.

- Specify the start and end points for the sample truncation using the data entry control, left/right cursor keys, inc/dec keys or the numeric keypad.
- Press **OK** to truncate the sample or **Cancel** to cancel the truncation.

❑ **Note:** If you are not happy with the resulting truncation or want to compare before and after, press the Undo function key (F6).

TAPER

Taper allows you to create an artificial decay on percussion samples where the original decay is absent, create an artificial fast attack on a sound (such as bowed violin with a slow attack), or clean up background noise when editing dialog.

► To Taper a Sample:

- Press the **Sample Edit** key. The LED will illuminate and the sample edit screen will appear. Select the sample.
- Press the **Tools 1** function key (F3). Another row of soft function keys will appear.
- Press the **Taper** function key (F3). The following screen will appear.

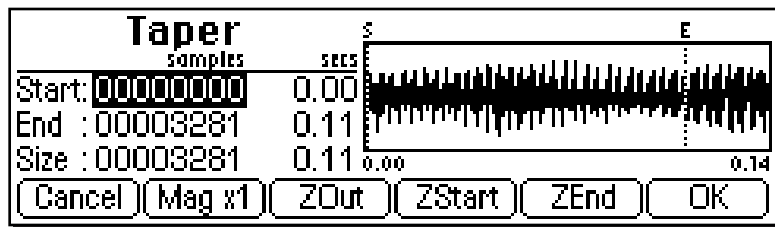

✦ **Tip:** Taper the ends of sounds before splicing to avoid clicks or pops at the splice point.

Insure that a sample starts at 0 and that no click happens at note on by using a very short taper (-96 to 0) on the attack.

- Specify the Start and End points for the portion of the sample to be tapered using the data entry control, left/right cursor keys, inc/dec keys or the numeric keypad.
- Press **OK** to continue on to the next page of options or **Cancel** to cancel the operation.

❑ **Note:** The Taper display is identical to the display in Truncate. See Truncate for a full description of the controls.

✦ **Tip:** The left and right cursor buttons will change the start and end points so that they fall on positive zero-crossing points in the waveform.

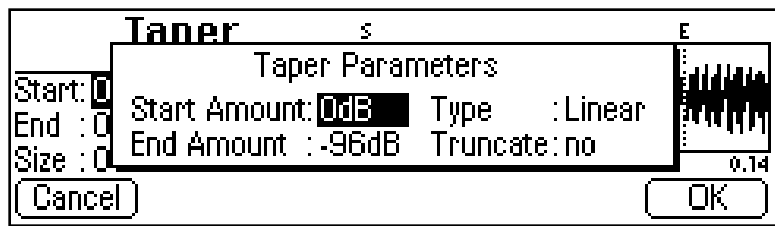

⚠ Caution: When using Taper Gain, avoid clipping the signal with too much gain. The Normalize display in the Gain Change submodule can be used as a sample headroom indicator.

📌 Tip: Percussive and plucked sounds are notoriously hard to loop. By Taper boosting the entire plucked sound +3 dB to +5 dB), using the default Start and End settings, a very natural kind of compression is applied which makes looping these sounds much easier.

Start with 0 dB and Taper up to +3 dB. As the sound decays, the gain will be boosted, leaving the attack of the sound unaffected.

Several more tapering parameters are shown.

- **Start Amount:** This is the amount of attenuation or gain applied at the start of the and is variable from -96 dB to +96 dB.
- **End Amount:** This is the amount of attenuation or gain applied at the end of the selected section and is also variable from -96 dB to +96 dB.
- **Type:** Selects the type of taper curve: Linear, Exponential 1, Exponential 2, Exponential 3. Graphs of these curves are shown below.
- **Truncate:** (After Taper) Discards any information after the taper end point in order to conserve memory.

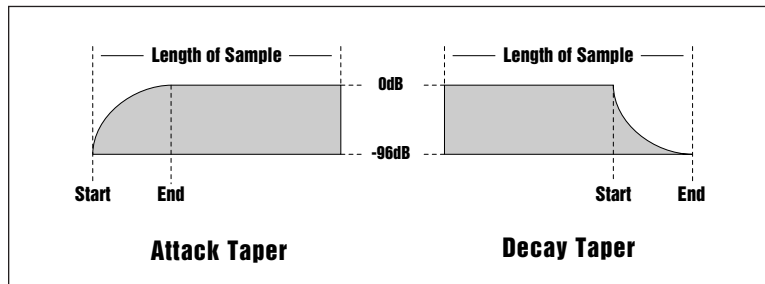

The diagram above shows the effect of Taper gain and attenuation on a sample using the Exp 3 curve.

6. Specify the taper parameters using the data entry control, or the inc/dec keys.
7. Press **OK** to taper the sample or **Cancel** to cancel the operation.

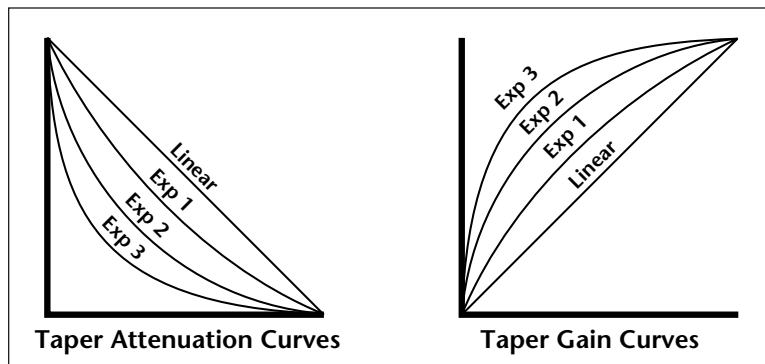

Sample Edit

GAIN CHANGE

Gain Change alters the level of all or part of a sample.

► To Change the Gain of a Sample:

1. Press the **Sample Edit** key. The LED will illuminate and the main sample edit screen will appear.
2. Select the sample that you want to Gain Change using the data entry control, inc/dec keys, or numeric keypad.
3. Press the **Tools 1** function key (F3). Another row of soft function keys will appear.

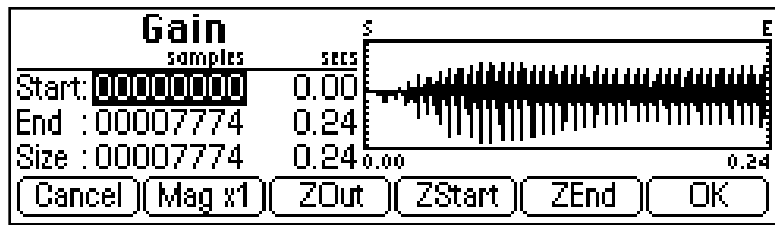

4. Press the **Gain** function key (F4). The following screen will appear.
- The Gain Change display is identical to the display in Truncate. See Truncate for a full description of the controls.
5. Specify the Start and End points for the portion of the sample to be gain changed using the data entry control, left/right cursor keys, inc/dec keys or the numeric keypad.
 6. Press **OK** to continue on to the next page of options or **Cancel** to cancel the operation.

Tip: The Start and End points are "remembered" from module to module so that you can perform successive operations on the same section of the sample.

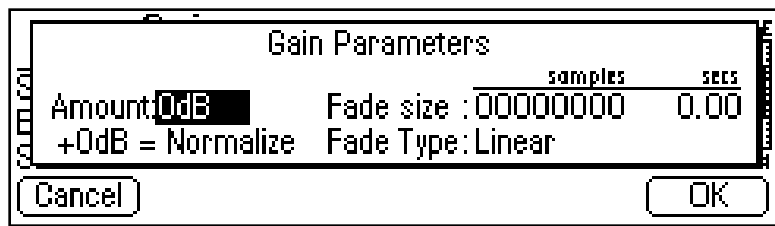

Several more parameters are shown.



- **Amount:** This is the amount of attenuation or gain applied to the selected section and is also variable from -96 dB to +96 dB.
- **Normalize:** This is a display showing the amount of gain change needed to achieve normalization or 0 dB headroom. Adding more positive gain change than the amount shown in the normalize display will cause the signal to clip.
- **Fade Size:** Set the length of the crossfade between the unaffected sample and the full amount of gain change.
- **Fade Type:** Selects the type of fade curve: Linear, Exp. 1, Exp. 2, Exp. 3. The graphs of these curves are shown below.

▣ **Note:** If you are not happy with the resulting gain change or want to compare before and after, press the Undo function key (F6).

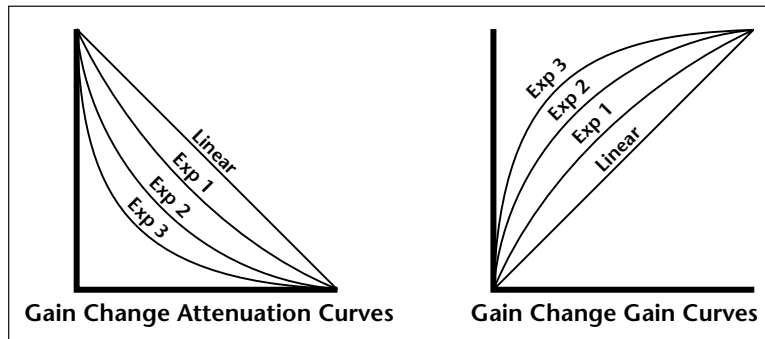

7. Specify the gain change parameters using the data entry control, or the inc/dec keys.
8. Press **OK** to change the gain of the sample section or **Cancel** to cancel the operation.

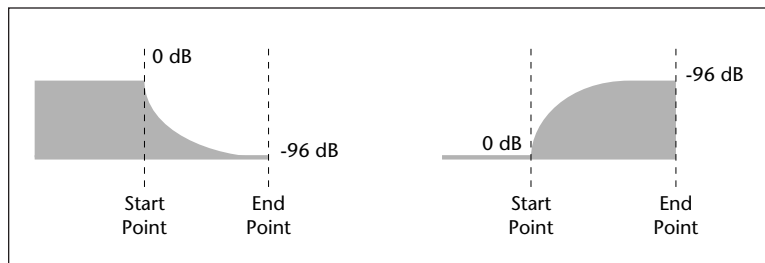

Gain fade-out and fade-in using the exponential 3 curve.



STEREO <-> MONO

Converts a stereo sample to mono or a mono sample to stereo. Converting to stereo duplicates the sample on both sides and slightly detunes them. Converting to mono sums both sides of the stereo sample, then divides by two.

► To Convert a Sample:

1. Press the **Sample Edit** key. The LED will illuminate and the main sample edit screen will appear.
2. Select the sample that you want to convert using the data entry control, inc/dec keys, or the numeric keypad.
3. Press the **Tools 1** function key (F3). Another row of soft function keys will appear.
4. Press the **S <-> M** function key (F5). A pop up display will ask you to confirm the operation.
5. Press **OK** to convert the selected sample or **Cancel** to cancel the operation.

 **Tip:** *converting mono samples to stereo enables you to process each side separately using copy, cut and paste.*

SWAP LEFT & RIGHT

Swaps sides of a stereo sample or moves a mono sample to the other side.

► To Swap Sides:

1. Press the **Sample Edit** key. The LED will illuminate and the main sample edit screen will appear.
2. Select the sample that you want to swap using the data entry control, inc/dec keys, or the numeric keypad.
3. Press the **Tools 1** function key (F3). Another row of soft function keys will appear.
4. Press the **SwapLR** function key (F6). A pop up display will ask you to confirm the operation.
5. Press **OK** to swap the selected sample or **Cancel** to cancel the operation.

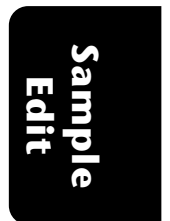

Tools 2

This submodule contains the digital processing tools listed below.

- **Sample Rate Convert:** Converts the sample to any sample rate between 7000 Hz and 50000 Hz.
- **Digital Tuning:** Digitally retunes a sample within a range of ± 1 octave.
- **Compression:** The compressor dynamically changes the gain of the sample based on the amplitude envelope of the sample. This is a non-realtime implementation of a full featured dynamic range compressor.
- **Parametric Equalization:** This is a digital (non real-time) implementation of a one band parametric EQ, with +12 dB boost or -48 dB of cut and completely variable frequency and bandwidth controls.
- **Reverse Sample:** Reverses all or part of a sample.

SAMPLE RATE CONVERT

Sampling at a high sample rate provides better frequency response than sampling at a slower rate, but uses up more memory. If you need to reclaim some of that memory, and are willing to trade off sample frequency response, samples can be converted from a higher rate to a lower one. Use your ear to compare sounds at the two sample rates. If you can't tell the difference, use the lower rate.

Sample Rate Conversion can be used for saving memory, increasing the upward transposition range of a sound, or exactly matching the sample rate to a multiple of the sound's frequency for perfect single cycle loop.

- Set the built-in sample calculator to the note you want to loop and it automatically calculates the number of samples in a single cycle loop.

- **Filtering** - Sample rate converters contain a low pass filter to prevent aliasing in the output. While the amount of filtering is automatically applied depending on the amount of change, three ranges of low pass filtering are provided to allow you more control over the output.

Crunchy	- Least amount of filtering - High frequency content retained, but sample may contain audible artifacts.
Smooth	- A medium amount of low pass filtering.
Creamy	- Maximum amount of low pass filtering - Some high frequencies will be removed.

► **To Change the Sample Rate**

1. Press the **Sample Edit** key. The LED will illuminate and the main sample edit screen will appear.
2. Select the sample that you want to process using the data entry control, inc/dec keys, or the numeric keypad.
3. Press the **Tools 2** function key (F4). Another row of soft keys will appear.
4. Press the **SrCnv** function key (F1). The following screen will appear.

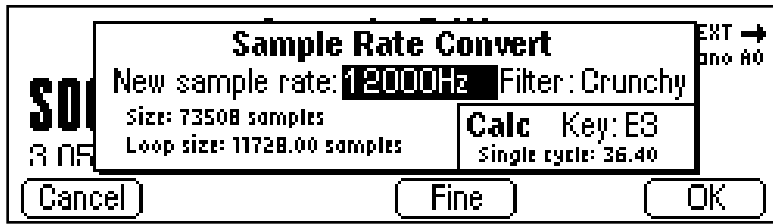

5. Enter the new sample rate using the data entry control, inc/dec keys, or the numeric keypad. The E4K will calculate the new sample size and new loop size.
- **Coarse/Fine** - Fast forward through the values using Coarse, then switch to Fine for single digit editing.
6. Set the low pass filter to the desired range: Crunchy, Smooth or Creamy.
 7. Press **OK** to change the sample rate or **Cancel** to cancel the operation.

■ **Note:** If you are not happy with the resulting conversion or want to compare before and after, press the Undo function key (F6).

■ **Note:** To use the mini sample calculator, simply move the cursor down to the Key field and use the data entry control to set the note. The calculator will display the number of samples in a single cycle loop at the selected sample rate. Select a sample rate where the single cycle loop has an integer value only.



▣ **Note:** Re-tuning pitch downward increases the sample size. Re-tuning pitch upwards decreases the sample size.

DIGITAL TUNING

Digital Tuning allows you to change the pitch of a sound in order to splice or combine it with another sound of a different pitch. Try offsetting the pitch of a copied sample by a few cents, then combine it with the original for flange and chorus effects. If a sample is slightly out of tune, it is usually better to fix the sample once and for all, rather than re-tuning the sample every time it is placed on the keyboard.

• **Filtering** - Digital Tuning utilizes a low pass filter to prevent aliasing in the output. Filtering is automatically applied depending on the amount of tuning, but the three ranges allow you to have more control over the output.

- | |
|---|
| Crunchy - Least amount of filtering - High frequency content retained, but sample may contain audible artifacts. |
| Smooth - A medium amount of low pass filtering. |
| Creamy - Maximum amount of low pass filtering. Some high frequencies will be removed. |

► To Retune a Sample

1. Press the **Sample Edit** key. The LED will illuminate and the main sample edit screen will appear.
2. Select the sample that you want to tune using the data entry control, inc/dec keys, or the numeric keypad.
3. Press the **Tools 2** function key (F4). Another row of soft keys will appear.
4. Press the **DigTune** function key (F2). The following screen will appear.

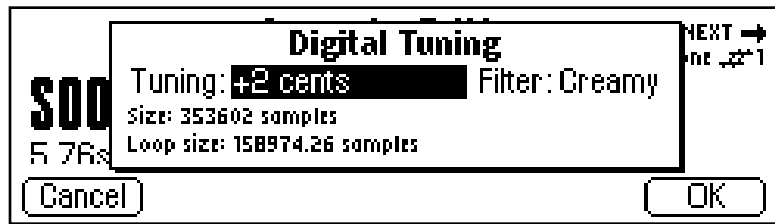

5. Enter the tuning amount in cents using the data entry control, or inc/dec keys. The E4K will calculate the new sample size and new loop size.
6. Press **OK** to retune the sample or **Cancel** to cancel the operation.

Sample
Edit

COMPRESSOR

The Digital Compressor is a digital (non-realtime) equivalent of an analog dynamic range compressor with attack and release times, adjustable threshold, adjustable ratio, and three modes of operation.

► To Compress a Sample:

1. Press the **Sample Edit** key. The LED will illuminate and the main sample edit screen will appear.
2. Select the sample that you want to compress using the data entry control, inc/dec keys, or the numeric keypad.
3. Press the **Tools 2** function key (F4). Another row of soft keys will appear.
4. Press the **Comp** function key (F3). The following screen will appear.

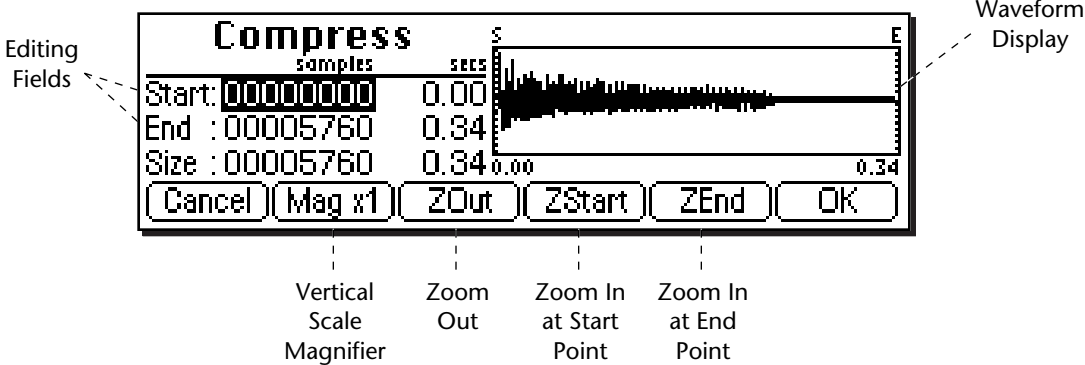

Tip: The Start and End points are "remembered" from module to module so that you can perform successive operations on the same section of the sample.

A visual display of the waveform appears with several controls.

- **Editing Fields:** Move the cursor to the desired field to change the Start and End points of the sample section to be compressed.
- **Magnification:** Adjusts the vertical scale for 1x, 2x, 4x, or 8x magnification. Pressing the button repeatedly rotates through the 4 options.
- **Zoom Start:** Magnifies the waveform to display finer detail around the Start point of the selected section.
- **Zoom End:** Magnifies the waveform to display finer detail around the End point of the selected section.
- **Zoom Out:** Reverses the effect of Zoom Start & Zoom End.

Tip: Holding down the Enter key while turning the data entry control allows "fine tuning" of the value by one number per click.

Sample Edit

5. Specify the start and end points for the section of the sample to be processed.
6. Press **OK** when you have selected the desired section or press **Cancel** to cancel the operation.

If you pressed “OK”, the following screen will appear.

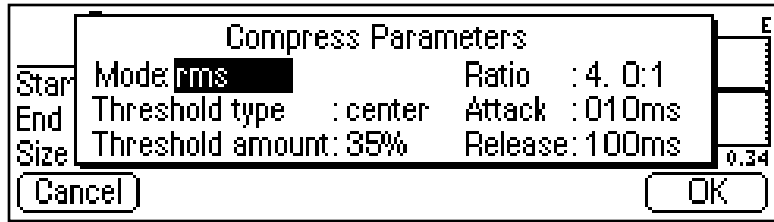

Mode

- **RMS:** Root-mean-square or an “average of the magnitude of the signal”. RMS represents the “true” energy content of a signal.
- **Peak:** Uses the peak amplitude of a signal to determine the amplitude. The peak amplitude is a meaningful measurement in a digital system because of the 96 db (16-bit) headroom limit.

Threshold

- **Above:** Only signal levels above the threshold % will be affected by the compressor.
- **Center:** Signal levels above as well as below the threshold % will be affected by the compressor.
- **Below:** Only signal levels below the threshold % will be affected by the compressor.
- **%:** Determines the threshold level as a percentage of 100% of 16-bits.

Compression Ratio

Determines the amount of compression or expansion. Ratios of greater than 1:1 **compress** dynamic range. Ratios of less than 1:1 **expand** dynamic range.

- **Compression:** Reduces the amount of dynamic range. Levels remain more constant.
- **Expansion:** Expands the amount of dynamic range. Changes in level are exaggerated.

Attack Time

Determines how quickly the gain will be turned down. The attack time is variable from 1 to 999 milliseconds.

Release Time

Determines how quickly the gain will be turned up. The release time is variable from 1 to 999 milliseconds.

7. Press **OK** when you have set the desired options or press **Cancel** to cancel the operation.

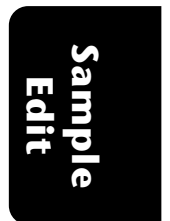

Only signal levels ABOVE the Threshold percentage will be affected by the compressor.

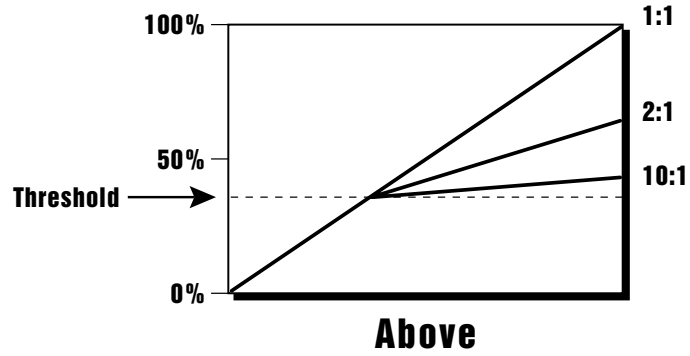

Signal levels ABOVE as well as BELOW the Threshold percentage will be affected by the compressor.

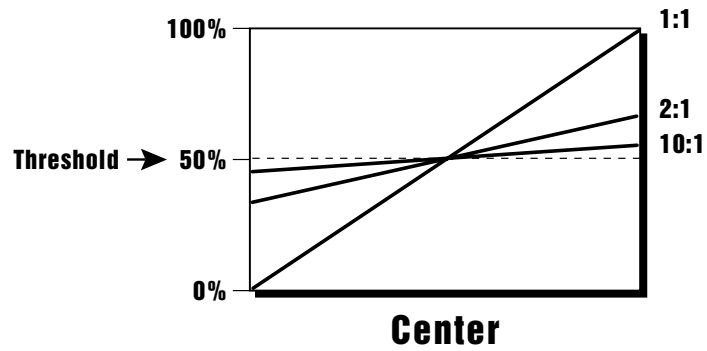

Only signal levels BELOW the Threshold percentage will be affected by the compressor.

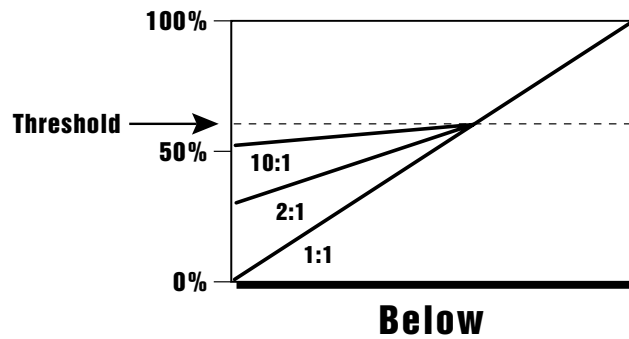

USING THE DIGITAL COMPRESSOR

Limiter

A limiter prevents the signal from exceeding a preset level (threshold). Signal levels below the threshold will be unaffected.

Set the controls as follows:

Threshold: Above, XX% (where XX is the limit point).

Ratio: >10:1

Attack Time: 1 mS

Release Time: approximately 100 mS

Musical Compression (e.g. Guitar)

This type of compression tries to keep the volume constant, generally to increase the sustain of the instrument. As the note dies away, the compressor will boost the level in an effort to keep the level constant.

Set the controls as follows:

Threshold: Center, XX% (where XX is the compression point).

Ratio: approximately 4:1

Attack Time: 1 mS to 100 mS

Release Time: > 100 mS

Noise Reduction

Noise reduction will reduce low levels even further in the assumption that low levels are noise.

Set the controls as follows:

Threshold: Below, approx. 30%

Ratio: approximately 0.7:1

Attack Time: approximately 100 mS

Release Time: approximately 100 mS

Tip: The Start and End points are “remembered” from module to module so that you can perform successive operations on the same section of the sample.

Tip: The left and right cursor buttons will change the start and end points so that they fall on positive zero-crossing points in the waveform. This will minimize clicks in the sound when processing only part of a sample.

Tip: Holding down the Enter key while turning the data entry control allows “fine tuning” of the value by one number per click.

PARAMETRIC EQUALIZER

Parametric EQ allows you adjust the individual parameters of the filter. **Boost/Cut** controls “how much” of the signal will be boosted or cut. **Center Frequency** sets the center frequency to be boosted or cut, and the **Bandwidth** control sets the width of the band to be boosted or cut. The three parameters are diagrammed on the following page.

The parametric equalizer is a digital (non real-time) equivalent of an analog equalizer with +12 db of boost and a whopping -48 dB of cut. Accurate center frequency and bandwidth controls are precise and have an exceptionally wide range.

► To Filter a Sample:

1. Press the **Sample Edit** key. The LED will illuminate and the main sample edit screen will appear.
2. Select the sample that you want to equalize using the data entry control, inc/dec keys, or the numeric keypad.
3. Press the **Tools 2** function key (F4). Another row of soft keys will appear.
4. Press the **ParEQ** function key (F4). The following screen will appear.

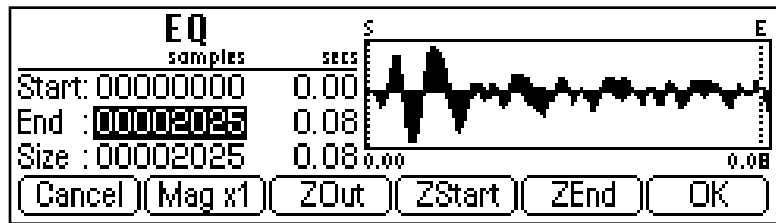

- The Select Section display controls are identical to the controls in Truncate. See Truncate for a full description of the controls.
5. Specify the Start and End points for the portion of the sample to be EQ'ed using the data entry control, left/right cursor keys, inc/dec keys or the numeric keypad.
 6. Press **OK** to continue on to the next page of options or **Cancel** to cancel the operation.

Sample Edit

The parametric equalizer parameters are shown.

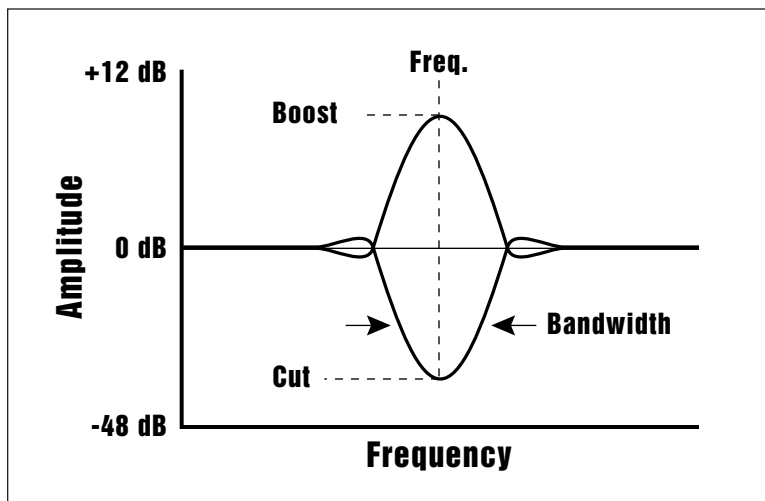
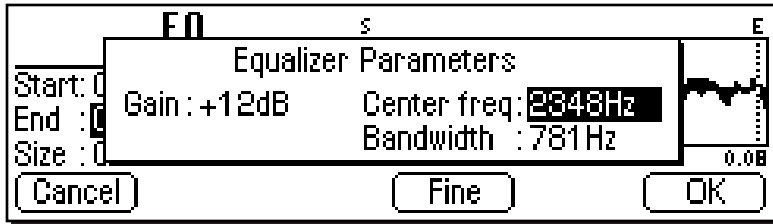

Tip: A standard analog parametric equalizer may be useful in order to locate the frequencies which need EQ. The digital EQ can then be used to actually filter the sample with ultra-low noise and phase linear response.

- **Gain:** Controls “how much” boost or cut will be applied to the signal.
 - **Center Frequency:** Selects the center frequency to be boosted or cut.
 - **Bandwidth:** Sets the width of the band to be boosted or cut.
7. Specify the parametric equalizer parameters using the data entry control or the inc/dec keys.
 - **Coarse/Fine:** Fast forward through the values using Coarse, then switch to Fine for single digit editing.
 8. Press **OK** to process the sample section or **Cancel** to cancel the operation.

Sample Edit

REVERSE SECTION

Reverses all or part of a sample.

Tip: The left and right cursor buttons will change the start and end points so that they fall on positive zero-crossing points in the waveform. This will minimize clicks in the sound when processing only part of a sample.

► To Reverse a Sample:

1. Press the **Sample Edit** key. The LED will illuminate and the main sample edit screen will appear.
2. Select the sample that you want to reverse using the data entry control, inc/dec keys, or the numeric keypad.
3. Press the **Tools 2** function key (F4). Another row of soft keys will appear.
4. Press the **Rev** function key (F5). The following screen will appear.

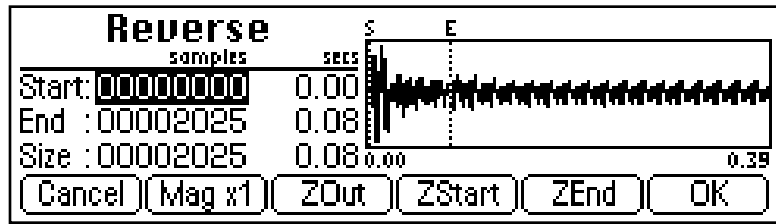

Tip: The Start and End points are "remembered" from module to module so that you can perform successive operations on the same section of the sample.

- The Select Section display controls are identical to the controls in Truncate. See Truncate for a full description of the controls.
5. Specify the Start and End points for the portion of the sample to be reversed using the data entry control, left/right cursor keys, inc/dec keys or the numeric keypad.
 6. Press **OK** to reverse the section or **Cancel** to cancel the operation.

**Sample
Edit**

Tools 3

This submodule contains the advanced digital processing tools listed below.

- **Time Compression:** This function changes the length of a sample without changing the pitch. This can be very useful for fitting samples to the beat of a song or fitting dialog into a spot. Samples can be compressed or expanded in length from 50% to 200%.
- **Pitch Change:** This function changes the pitch of a sample without changing the time relationships between events. The maximum amount of pitch change is ± 1200 cents (\pm one octave).
- **Transform Multiplication:** This function merges two sounds together in a unique way which can create many strange and beautiful sonic textures. Frequencies common to the original sounds are accentuated while uncommon frequencies are discarded.
- **Doppler:** This unique function allows you to dramatically move a sound from front to back and side to side in a 2-D space. Several pre-computed paths are available.
- **Exciter:** This function adds brilliance and “cut” to a sample, helping it to stand out in a mix. The exciter works by adding high order harmonics related to the source material.

■ **Note:** Stereo samples maintain phase accuracy when time compressed or expanded.

TIME COMPRESSION

This function allows you to change the length of a sample without changing the pitch. This is a useful function for fitting samples to the beat of a song or fitting dialog into a spot. Samples can be compressed or expanded in length from 50% to 200% in steps of 1/10th of one percent.

The tempo calculator makes it easy to change the tempo of sampled grooves. Simply set the original tempo to the tempo of the groove, then adjust the ratio until the new tempo matches the tempo you want.

► To Compress the Time of a Sample:

1. Press the **Sample Edit** key. The LED will illuminate and the main sample edit screen will appear.
2. Select the sample that you want to process using the data entry control, inc/dec keys, or the numeric keypad.
3. Press the **Tools 3** function key (F5). Another row of soft keys will appear.
4. Press the **TC** function key (F1). The following screen will appear.

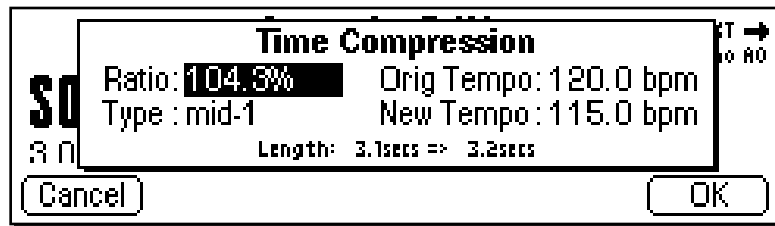

5. Enter the desired time compression (or expansion) ratio using the data entry control, inc/dec keys, or the numeric keypad. The lower line of the display will change to show the resulting length of the compressed or expanded sample. The New Tempo calculation will also update according to the entered Ratio.

- **Time Compression Ratios:** 200% = Doubles the Length
50% = Half the Length

6. Select the general type of sample to be processed.

The choices are listed on the following page.

Sample
Edit

deep	Predominant deep bass (to 14 Hz)
bass	Predominant bass (to 20 Hz)
mid-1	Average source material
mid-2	Average source material (high-mids)
high	Source material with high frequencies
tight	Maintains time accuracy - Drum loops
broad	Low bass energy but critical highs
broad-smooth	Both high & low freq. - Smooth output
difficult	Inharmonic or broadband material
noisy	Non-pitched - Sound Effects, etc.

❑ **Note:** If you are not happy with the results of Time Compression, simply Undo, then choose another algorithm.

7. Press **OK** to process the sample or **Cancel** to cancel the operation.

PITCH CHANGE

This function is the exact opposite of Time Compression in that it changes the pitch of a sample without changing the time. The maximum amount of pitch change is ± 1200 cents (\pm one octave).

► To Change the Pitch of a Sample:

1. Press the **Sample Edit** key. The LED will illuminate and the main sample edit screen will appear.
2. Select the sample that you want to process using the data entry control, inc/dec keys, or the numeric keypad.
3. Press the **Tools 3** function key (F5). Another row of soft keys will appear.
4. Press the **PC** function key (F2). The following screen will appear.

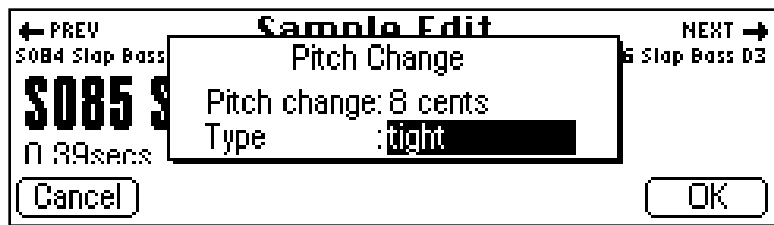

5. Enter the desired pitch change interval in cents using the data entry control, inc/dec keys, or the numeric keypad.
6. Select the general type of sample to be processed.

The choices are:

deep	Predominant deep bass (to 14 Hz)
bass	Predominant bass (to 20 Hz)
mid-1	Average source material
mid-2	Average source material (high-mids)
high	Source material with high frequencies
tight	Maintains time accuracy - Drum loops
broad	Low bass energy but critical highs
broad-smooth	Both high & low freq. - Smooth output
difficult	Inharmonic or broadband material
noisy	Non-pitched - Sound Effects, etc.

❑ **Note:** *If you are not happy with the results of Pitch Change, simply Undo, then choose another algorithm.*

7. Press **OK** to process the sample or **Cancel** to cancel the operation.

TRANSFORM MULTIPLICATION

This unique function merges two sounds together in a way that frequencies common to both sounds are accentuated while uncommon frequencies are discarded. Because of this characteristic, Transform Multiplication tends to work best with sounds that are harmonically rich. Using this function is easy, just pick two sounds and go. The length of the resulting sample will be equal to that of the current sample.

★ **Caution:** *Transform Multiplication can take quite a bit of time with longer samples. Begin your experiments with short samples or even sample attacks as these will give good initial results.*

► To Transform Multiply Two Samples:

1. Press the **Sample Edit** key. The LED will illuminate and the main sample edit screen will appear.
2. Select the first sample that you want to multiply using the data entry control, inc/dec keys, or the numeric keypad.
3. Press the **Tools 3** function key (F5). Another row of soft keys will appear.

**Sample
Edit**

4. Press the **XMult** function key (F3). The following screen will appear.

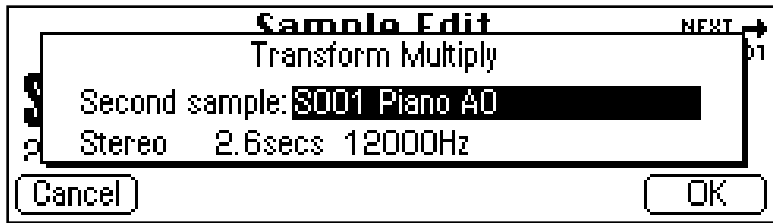

5. Select the second sample to be multiplied using the data entry control or the inc/dec keys. The second line of the window will show the sample length and rate of the second sample.
6. Press **OK** to begin processing or **Cancel** to cancel the operation.

Transform Multiplication Ideas:

- Try using the same sound for both samples.
- Splicing silence to the beginnings or ends of short samples can change the spectral characteristics of the result.
- Using speech as one of the sources, it is possible to "speak from within" violins, bassoons, cymbals, etc.

DOPPLER

This function allows you to apply a programmed sound path to a mono sample or the left side of a stereo sample. The result is a stereo sample with pitch shifts and left-right gains adjusted according to the path. The sound can move dramatically forward-back and left-right in a 3-D space in front of the listener. Several interesting programmed paths are available.

► To Doppler Shift a Sample:

1. Press the **Sample Edit** key. The LED will illuminate and the main sample edit screen will appear.
2. Select the first sample that you want to multiply using the data entry control, inc/dec keys, or the numeric keypad.
3. Press the **Tools 3** function key (F5). Another row of soft keys will appear.
4. Press the **Doppler** function key (F4). The following screen will appear.

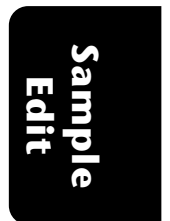

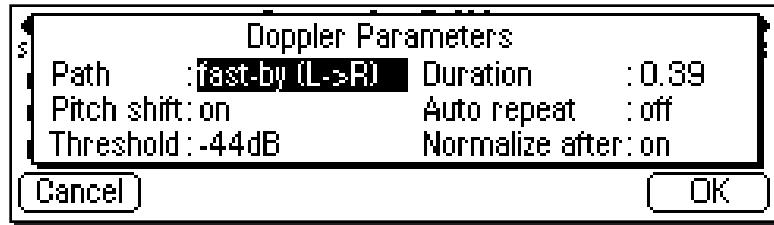

The doppler parameters are as follows:

- **Path:** Sets the course that the sound will travel.
- **Pitch Shift:** (On/Off) When pitch shift is turned Off, the processor functions as an auto-panner.
- **Threshold:** Certain sound paths may take the sound source very far away from the listener, resulting in little or no resulting amplitude. The “Threshold” parameter specifies the maximum amplitude attenuation of the original sample that will ever occur. By setting this parameter appropriately, you can ensure that the resulting sample will produce at least a minimum amplitude output at every point along the path. A setting of 0 dB would prevent any amplitude changes whatsoever. A setting of -96 dB would not prevent the sound from completely fading away at some points.
- **Duration:** The Path Duration allows you to scale the path time so that it runs to completion in a time shorter than the length of the sample. The default value is always the length of the sample. If auto-repeat is Off (see below), the sound will remain at the end of the path until the sample is complete.
- **Auto Repeat:** Auto repeat causes the path to repeat if the end is reached before the sample has completely played. Auto repeat will only occur if path duration is set to a value less than the sample length. The default setting for auto repeat is Off.
- **Normalize After:** This function (when On) automatically normalizes the sample after the doppler processing has been performed.

5. Specify the doppler parameters using the data entry control or the inc/dec keys.

The Path choices are as follows:

Fast-by (L->R) ---- Sound moves left to right quickly
Slow-by (L->R) --- Sound moves left to right slowly
Far->Near (fast) - Sound moves far away to close quickly
Far->Near (slow) Sound moves far away to close slowly
Near->Far (fast) - Sound moves close to far away quickly
Near->Far (slow) Sound moves close to far away slowly
Small Circle----- Sound moves in an 8 ft. circle in front
Medium Circle -- Sound moves in a 50 ft. circle in front
of you
Large Circle----- Sound moves in a 120 ft. circle in
front of you
Huge Circle ----- Sound moves in a 250 ft. circle in
front of you
Random 1 ----- Sound moves in a random path in
front of you
Random 2 ----- Sound moves in a different random
path

The computed paths are always initially scaled to the length of the sample, although this time may be changed using the Duration parameter.

6. Press **OK** to process the sample or **Cancel** to cancel the operation.

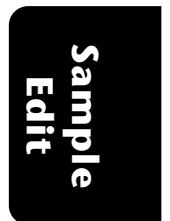

EXCITER

This function adds brilliance and “cut” to a sample, making stand out in a mix. This effect is especially effective on vocal samples to which it adds sheen, clarity and presence. The exciter works by generating new harmonics related to the source material.

► To Add Excitement to a Sample:

1. Press the **Sample Edit** key. The LED will illuminate and the main sample edit screen will appear.
2. Select the first sample that you want to multiply using the data entry control or the inc/dec keys.
3. Press the **Tools 3** function key (F5). Another row of soft keys will appear.
4. Press the **Exciter** function key (F5). The standard Start & End Point selection screen will appear. Specify the start and end points for the effect, then press **OK** to continue or **Cancel** to cancel the operation.

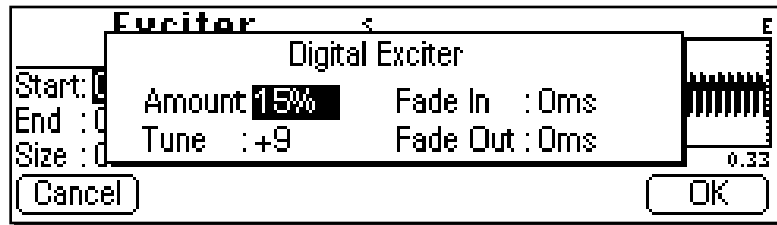

The exciter parameters are as follows:

- **Amount:** Sets the intensity of the effect. Lower values (<40%) tend to work best as they keep the effect subtle.
- **Tune:** Sets the frequency range of the effect. Higher numbers emphasize higher frequencies.
- **Fade In:** Sets the amount of time from the start point for the effect to fade in to the programmed amount.
- **Fade Out:** Sets the amount of time before the end point that it will take for the effect amount to fade out to zero.

5. Specify the exciter parameters using the data entry control or the inc/dec keys.
6. Press **OK** to process the sample or **Cancel** to cancel the operation.

Undo

Have you ever wanted a time machine so that you could go back and undo a mistake? This function may be the next best thing. Whenever you perform a sample edit function, the E4K backs up the original version of the sample if “Undo/Redo” is enabled (Master, Miscellaneous). The original sample is placed on the clipboard and can be instantly restored by pressing Undo.

► To Restore a Sample to its Original State

1. Press the **Sample Edit** key. The LED will illuminate and the main sample edit screen will appear.
2. Press the **UNDO!** function key (F6). The original sample will be restored and the processed sample will be stored in the clipboard.

► To Compare a Processed Sample with the Original Sample:

1. Press the **Sample Edit** key. The LED will illuminate and the main sample edit screen will appear.
2. Press the **UNDO!** function key (F6). The original sample will be restored and the processed sample will be stored in the clipboard.
3. Press the **REDO!** function key (F6). The processed sample will be restored and the original sample will be stored in the clipboard. You can continue switching back and forth until you decide which sample you want to keep.

**Sample
Edit**

Preset Manage

Name Preset	236
Erase Preset	237
Copy Preset	238
New Preset	239
Export Preset	240
Get Info	241

PRESET MANAGE



This module handles the preset “housekeeping” functions such as: creating, erasing, copying, exporting naming presets. You can also find out how much memory a preset uses, to which output it is assigned, and if it is linked to another preset.

The Preset Manage menu contains five main sub menus:

- **Name** - Allows you to name or rename a preset.
- **Erase** - Allows you to erase a preset from memory.
- **Copy** - Allows you to copy a preset to another location.
- **New** - Creates a new preset location.
- **Export** - Allows you to export a preset into another bank.
- **Info** - Displays information on the selected preset.

Name Preset



This function allows you to name any preset in the bank.

► To Name a Preset:

1. Press the **Preset Manage** key. The LED will illuminate and the main screen will appear.
2. Select the preset to be named using the data entry control, inc/dec keys, or the numeric keypad.
3. Press the **Name** function key (F1). A popup dialog box (shown above) will appear asking you to enter the new preset name.
4. Name the preset. Letters can be selected using the numeric keypad, data entry control, inc/dec keys and cursor keys, or using an ASCII keyboard.
5. Press **OK** to confirm the new name or **Cancel** to cancel the operation.

Erase Preset



This function allows you to erase any preset in the bank.

► To Erase a Preset:

1. Press the **Preset Manage** key. The LED will illuminate and the main screen will appear.
2. Select the preset to be erased using the data entry control, inc/dec keys, or the numeric keypad.
3. Press the **Erase...** function key (F2). A pop-up dialog box (shown above) will appear asking you if you want to erase the preset.
4. Press **OK** to erase the preset or **Cancel** to cancel the operation.

Copy Preset



Presets can be copied to other preset numbers within the bank.

► To Copy a Preset:

1. Press the **Preset Manage** key. The LED will illuminate and the main screen will appear.
2. Press the **Copy...** function key (F3). A pop-up dialog box (shown above) will appear asking you to select the destination preset location.
3. Select the destination preset location using the data entry control, inc/dec keys or the numeric keypad.
4. Press **OK** to copy the preset or **Cancel** to cancel the operation.

New Preset

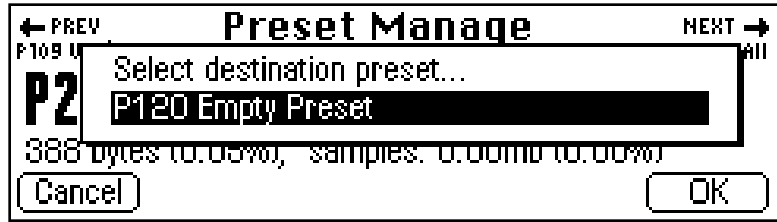

This function creates a home for your great samples.

► To Create a New Preset:

1. Press the **Preset Manage** key. The LED will illuminate and the main screen will appear.
2. Press the **New...** function key (F4). A popup dialog box (shown above) will appear asking you to select the destination preset location.
3. Select the destination preset location using the numeric keypad, data entry control, inc/dec keys or using an ASCII keyboard.
5. Press **OK** to confirm the new preset location or **Cancel** to cancel the operation.

Export Preset



This function allows you to export a preset to another bank. Suppose you were experimenting and modified a preset using the preset edit module. You might want to keep the modified preset, but if you save the bank, the original preset will be lost. Using this function, you can export the modified preset and its samples to a new bank and have both!

► To Export a Preset:

1. Press the **Preset Manage** key. The LED will illuminate and the main screen will appear.
2. Select the preset to be exported using the data entry control, inc/dec keys, or the numeric keypad.
3. Press the **Export** function key (F5). The screen shown above will appear.
4. Select the destination drive, folder and bank using the cursor keys and data entry control. You cannot write into an existing bank without erasing it. Usually you will choose an empty bank.
5. Press **OK** to export the preset or **Cancel** to cancel the operation.

Get Info



This function displays the preset's size in bytes, lists the number of samples used and lists the amount of remaining memory. It also tells you if the preset is linked to another and to which output it is assigned.

► To Get Information about a Preset:

1. Press the **Preset Manage** key. The LED will illuminate and the main screen will appear.
2. Select the desired preset using the data entry control, inc/dec keys, or the numeric keypad.
3. Press the **Info...** function key (F6). A pop-up window (shown above) appears with information about the sample.
4. Press the **OK** function key to return to the Preset Manage screen.

Preset Edit

Background	
<i>Programming Basics</i>	244
<i>Dynamic Filter</i>	258
<i>Selecting Voices, Samples & Groups</i>	264
<i>Groups</i>	266
<i>Preset Editor</i>	267
Preset Edit - Global	270
<i>Preset Effects A</i>	271
<i>Preset Effects B</i>	276
Preset Edit - Links	280
<i>Utilities</i>	281
<i>Links - Key Window</i>	284
<i>Links - Velocity Window</i>	284
Preset Edit - Voices	288
<i>Utilities</i>	289
<i>Sample Zone</i>	293
<i>Voices - Key Window</i>	297
<i>Voices - Velocity Window</i>	302
<i>Voices - Realtime Window</i>	305
Preset Edit - Dynamic Processing	308
<i>Utilities</i>	311
<i>Voice Tuning, Modifiers & Setup</i>	319
<i>Amplifier/Filter</i>	328
<i>LFO/ Auxiliary Envelope</i>	336
<i>Cords</i>	339

BACKGROUND: Programming Basics

This chapter explains how preset sounds are constructed in the E4K. It also contains important background information on the various programming aspects of the instrument.

If you are new to synthesizers and electronic music, you may need more background information than this manual provides. There are many books dedicated to synthesizer basics and MIDI available through your local music dealer. Magazines such as Keyboard and Electronic Musician, which are available at most newsstands, contain current information on the subject, as well as valuable programming tips.

Your initial involvement with the E4K will most likely consist of using the existing presets and selecting MIDI channels. While the factory banks and presets are very good, there are probably some things you would like to change, perhaps the LFO speed, the filter brightness, or the attack time. You may also want to make your own custom presets using complex modulation routings.

Editing Presets

It's easy to create new presets by using the Preset Edit menu to modify existing presets. This is really the best way of getting acquainted with the E4K. If you don't like the results, simply reload the preset and you'll be back to the original sound. Changes are not made permanent until you SAVE a bank. Therefore, you can experiment all you want with presets, voices and samples without worrying about losing a sound.

We encourage you to actually try out the different functions as you read about them. Hearing what a control actually does will remove a lot of the mystery associated with it.

The E4K has an extensive modulation implementation using two multi-wave LFO's (Low Frequency Oscillators), three envelope generators, and the ability to respond to multiple MIDI performance controllers. You can simultaneously route any combination of these control sources to multiple destinations.

MODULATION

Modulation means to *dynamically change* a parameter, whether it be the volume (amplitude modulation), the pitch (frequency modulation), or whatever. Turning the volume control on your home stereo rapidly back and forth would be an example of amplitude modulation. To modulate something we need a modulation *source* and a modulation *destination*. The source is your hand turning the knob, and the destination is the volume control. If we had a device that would automatically turn the volume control, we would also call that device a modulation source.

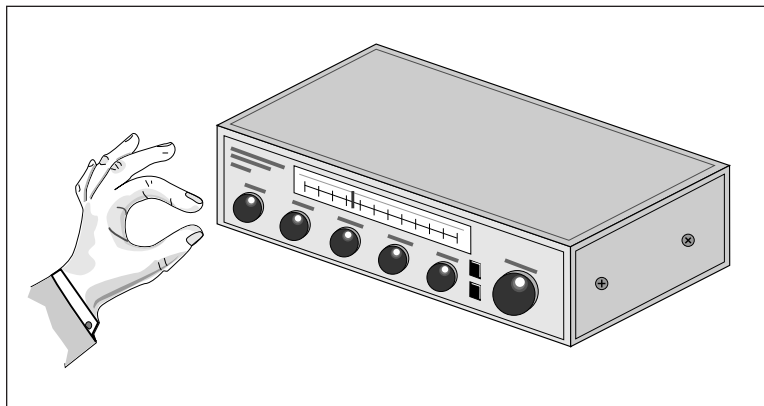

Turning the volume control back and forth on your home stereo is an example of Amplitude Modulation.

The E4K is designed so that for each of the variable parameters, such as the volume, there is an initial setting which can be changed by a modulation source. Therefore in the case of volume, we have an initial volume and we can change or modulate that volume with a modulation source. Positive modulation *Adds* to the initial amount. Negative modulation *Subtracts* from the initial amount.

Tip: Try routing Key Glide to Filter Frequency if you want the filter to smoothly follow pitch in solo mode. Routing Key Glide to Pan is another interesting effect.

MODULATION SOURCES

The main modulation sources on the E4K are *Envelope Generators*, *Performance Controllers* and *Low Frequency Oscillators*. In the previous example, an envelope generator could be routed to automatically turn the volume control as programmed by the envelope, or, a low frequency oscillator could be routed to turn the volume control up and down in a repeating fashion. The main mod sources are listed below.

Keyboard Key

Which key is pressed.

Key Velocity

How fast the key is pressed.

Up Velocity

How fast the key is released.

Gate

High if the key is pressed, low when the key is released.

Key Glide

A smoothly changing control source based on the Glide Rate and the interval between the last two notes played.

Pitch and Mod Wheels

Synthesizer pitch bend and modulation wheels.

Keyboard Pressure (mono aftertouch)

Key Pressure applied after the key is initially pressed.

Pedal

A continuously variable pedal controller.

Miscellaneous Controllers A & B

Any type of MIDI continuous controller data.

Low Frequency Oscillators (2 per preset)

Generate repeating waves.

Envelope Generators (3 per preset)

Generate a programmable “contour” which changes over time when a key is pressed.

Noise & Random Generators

Generate spectrums of noise and random signals.

Thumbby Button and Footswitches

Change a parameter when the switch is pressed.

MODULATION CORDS

To connect a modulation Source to a Destination you use a **Cord**. (*Patchcord*—A holdover from the days when modules of an analog synthesizer were connected together with physical cords. Nowadays, we still need a way to connect modules together, but the cords are in software.)

The E4K lets you connect the modulation sources in almost any possible way to the modulation destinations. You can even modulate other modulators. Each cord also has an amount parameter which determines “how much” modulation is applied to the destination. The modulation amount can be positive or negative and will either add or subtract from the initial value.

To use a modulation cord, you must connect a modulation Source to a modulation Destination. Think of it as if you are connecting an actual cord. **You must connect both ends of the cord for the cord to work.** There are 18 general purpose cords per voice.

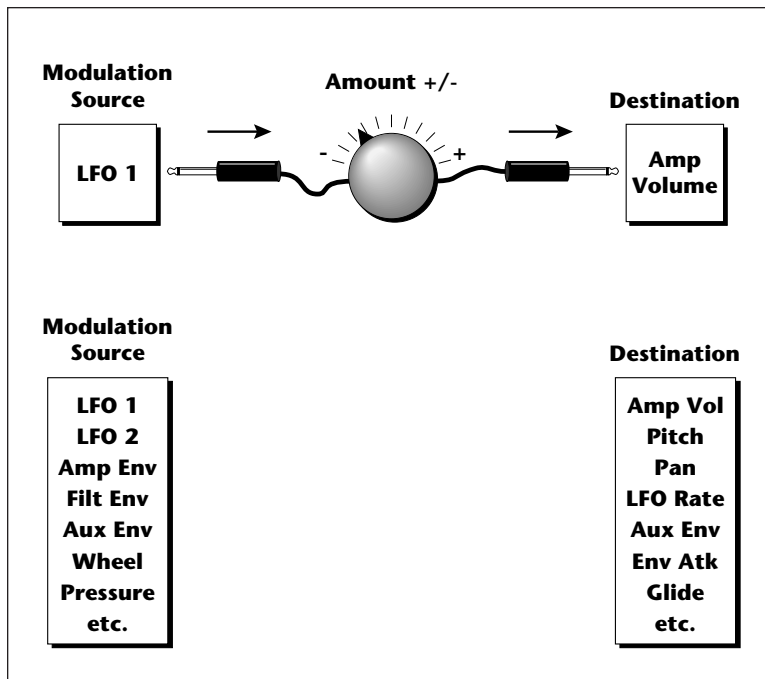

ENVELOPE GENERATORS

An envelope can be described as a “contour” which can be used to shape the sound in some way over time. There are three envelope generators on the E4K and all of them are the rate/level type.

This is how the rate/level envelopes work: When a key is pressed, envelope starts from zero and moves toward the Attack 1 Level at the Attack 1 Rate. As soon as it reaches this first stage, it immediately begins the Attack 2 phase and moves toward the Attack 2 level at the Attack 2 rate. As long as the key is still held, the envelope continues on through the Decay 1 and Decay 2 stages. If the key is still held when the envelope reaches the end of Decay 2, it simply stops there waiting for you to release the key. When you release the key, the envelope continues through its Release 1 and Release 2 stages, stopping at the end of the Release 2 stage. The rate/level envelopes give maximum flexibility to program both complex and simple envelopes.

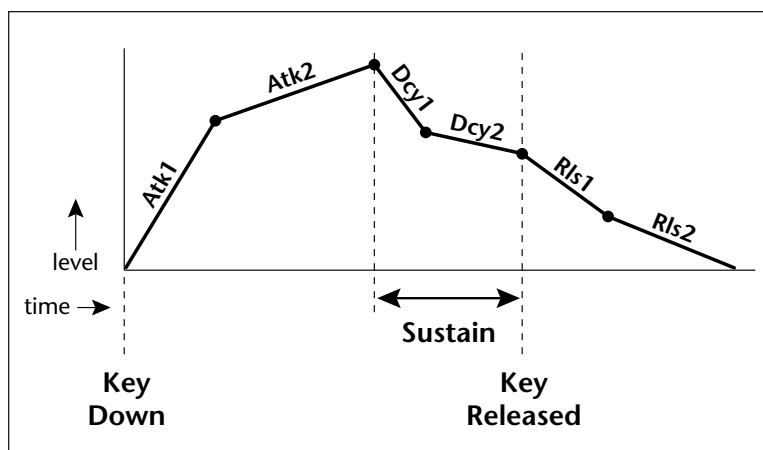

The Amplifier Envelope generator controls the volume of the voice over time and has 6 stages: Attack 1, Attack 2, Decay 1, Decay 2, Release 1 and Release 2. The Filter Envelope generator controls the filter morph and also has 6 stages. Unlike the amplifier envelope, however, the filter envelope has the ability to go negative as well as positive. There is also an Auxiliary Envelope generator which is a general purpose envelope. The auxiliary envelope is identical to the filter envelope and can go negative as well as positive.

The time of each stage can be adjusted to create myriad envelope shapes, which in turn shape the sound over time.

- The way the volume of a sound changes over time determines how we perceive that sound. For example, a bell struck with a hammer is instantly at full volume, then slowly dies away. A bowed violin sound fades in more slowly and dies away slowly. Using the Amplifier Envelope, you can simulate different types of instrument volume envelopes by programming them appropriately.

Tip: By routing the Auxiliary Envelope to control the pitch (Cords) you can easily hear the shape of the envelopes you are creating.

LOW FREQUENCY OSCILLATORS (LFOs)

A Low Frequency Oscillator or LFO is simply a wave which repeats at a slow rate. The E4K has two multi-wave LFOs for each of its 128 channels. The LFO waveforms are: Triangle, Sine, Sawtooth, and Square.

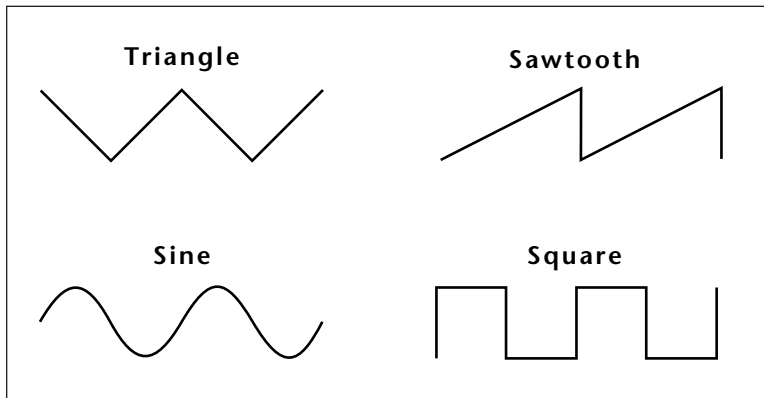

By examining the diagram of the LFO waveforms, you can see how the LFO will affect a modulation destination. Suppose we are modulating the pitch of an instrument. The sine wave looks smooth, and will smoothly change the pitch. The square wave changes abruptly, and will abruptly change the pitch from one pitch to another. The sawtooth wave smoothly decreases, then abruptly changes back up. The sound's pitch will follow the same course. Controlling the pitch of an instrument is an easy way to hear the effects of the LFO waves.

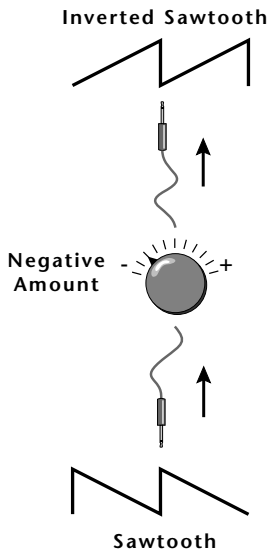

Tip: For more info on the Crossfade Random function see *Voices - Realtime Window* in this chapter.

Like the Auxiliary Envelope, the LFOs can be routed to control any realtime functions such as Pitch, Filter, Panning, or Volume. A common use for the LFO is to control the pitch of the sound (LFO -> Pitch). This effect is called vibrato and is an important performance parameter. Many presets use this routing with the modulation wheel controlling “how much” LFO modulation is applied. Another common effect, Tremolo, is created by controlling the volume of a sound with the LFO (LFO -> Volume).

Another use for the LFOs might be to add a slight bit of animation to the sound by routing the LFO to control the filter. In this example, the LFO amount would be set low, for a subtle effect.

When the amount of an LFO is a negative value, the LFO shape will be inverted. For example, inverting the sawtooth wave produces a wave that smoothly increases, then instantly resets down.

RANDOM SOURCES

The E4K contains several random sources. **Key Random 1 & 2** generate different random values for each voice which do not change during the note. The **White & Pink Noise Generators** produce varying random values. Both white and pink noise sources are low frequency noise designed for control purposes. Either noise source can be filtered even more by passing it through a lag processor. The **Crossfade Random** function generates the same random value for all voices in a preset. This source is designed to be used for crossfading voices, although you may find other uses.

MODULATION DESTINATIONS

The **Cords** section of the Preset Edit module is where you connect sources to destinations. Each cord has an amount control associated with it to control how much modulation is applied.

Cords 00 to 05			[M] V1: A-1:C7				
#	source	dest	amount	#	source	dest	amount
00	Vel<	Filter	+28%	03	Mod/Wl	CO3Amt	+13%
01	Pit/Wl	Pitch	+9%	04	Vel~	Filter	+24%
02	Lfo1~	Pitch	+0%	05	Pedal	Filter	+0%

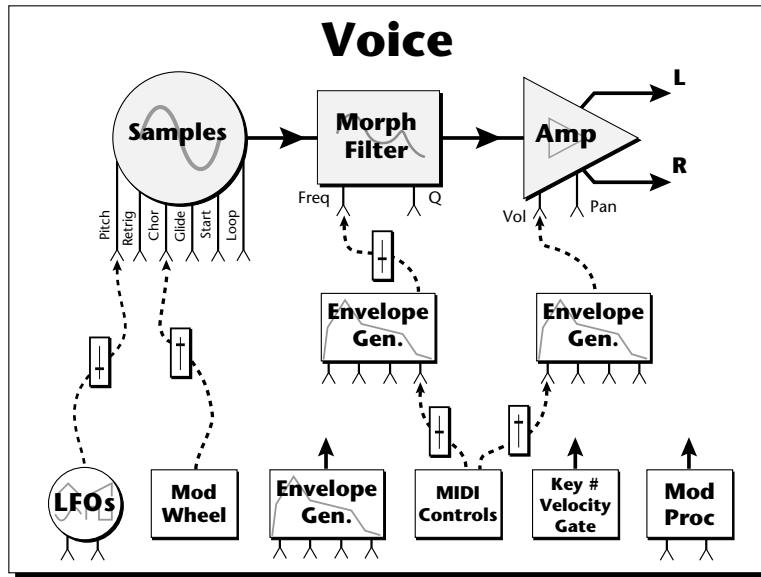

The Cords screen on the previous page and the diagram above show how modulation sources are connected to destinations. The modulation sources can control any of the destinations in the voice.

- Note-on modulation sources, such as key, velocity and gate output a single value at note-on time. Realtime modulation sources such as LFOs, envelope generators and modulation wheels can be varied continuously.

The possible modulation routings are completely flexible as shown in the diagram above. Multiple sources can control the same destination, or a single source can control multiple destinations.

+	0 ... 127
~	-64 ... +63
<	-127 ... 0

Several of the modulation sources use the designators shown at left to indicate their polarity.
 "+" modulation adds to the current value.
 "~" is useful when you want the modulation to center around zero. (As when controlling Filter Fc.)
 "<" would be useful for controlling volume, as it only subtracts from the initial value.

Modulation Sources

- Off
- Crossfade Random
- Key (+, ~), Velocity (+, ~, <)
- Release Velocity, Gate
- Pitch Wheel, Mod Wheel
- Pressure, Pedal
- MIDI A-H, Foot Switch 1 & 2
- Flip-Flop Foot Switch 1 & 2
- MIDI Volume (Contr. 7)
- MIDI Pan (Contr. 10)
- Key Glide
- Volume Envelope (+, ~, <)
- Filter Envelope (+, ~, <)
- Aux. Envelope (+, ~, <)
- LFO 1 & 2 (+, ~)
- White Noise, Pink Noise
- kRandom 1 & 2,
- Lag 0 in (summing amp out)
- Lag 1 in (summing amp out)
- Lag Processor 0 & 1
- DC Offset, Summing Amp
- Switch, Absolute Value
- Diode, Flip-Flop, Quantizer
- Gain 4x

Modulation Destinations

- Off
- Key Sustain, Fine Pitch, Pitch
- Glide, Chorus Amt
- Chorus Position ITD
- Sample Start, Sample Loop
- Sample Retrigger
- Filter Freq., Filter Resonance
- Amplifier Volume, Amp Pan
- Amplifier Crossfade
- Volume Envelope Rates (all)
- Vol. Env. Atk, Dcy, Release
- Filter Envelope Rates (all)
- Filt. Env. Atk, Dcy, Release
- Aux. Envelope Rates (all)
- Aux. Env. Atk, Dcy, Release
- LFO 1 & 2 Rates
- Lag Processor In 0 & 1
- Summing Amp, Switch
- Absolute Value
- Diode, Flip-Flop, Quantizer
- Gain 4x
- Cord 0-15 Amount

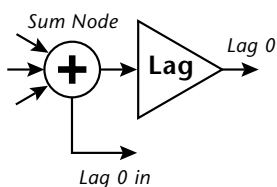

Tip: The Lag Processors can also be used as 2 additional summing amps. Lag0in and Lag1in are available as modulation sources which are the sum of any cords connected to the Lag in destination. The summing amp is before the lag processor as shown above.

MODULATION PROCESSORS

Modulation processors are devices which can modify modulation sources such as LFOs and envelope generators before they are applied to a destination. The E4K's modulation processors allow you to create patches and do tricks which would not be possible otherwise. The following modulation processors are currently implemented.

Switch Outputs a digital "1" when the input is greater than "0".

Summing Amp .. Allows you to mix several modulation signals together before applying them to a destination. This saves cords when the output is to be routed to multiple destinations.

Lag Processors ... Slows down rapid changes in the input signal. The output "lags" behind the input at a programmed rate (set in the LFO 2 screen).

Absolute Value .. This function inverts negative values presented to it and leaves positive values alone. This device outputs only positive values.

Diode This function only allows positive values to pass and blocks negative values.

Flip-Flop The output of this processor alternates between a digital "1" and digital "0" each time the input goes positive from zero or a negative value. If an LFO wave were input, the output would be a square wave of half the input frequency.

Quantizer With the input cord set to 100%, the output value is limited to 16 discrete values (If the input = sawtooth, then the output = staircase). The value of the input cord controls the number of steps. The value of the output cord controls the size of the steps.

4x Gain This processor multiplies the input value by 4 to amplify modulation sources.

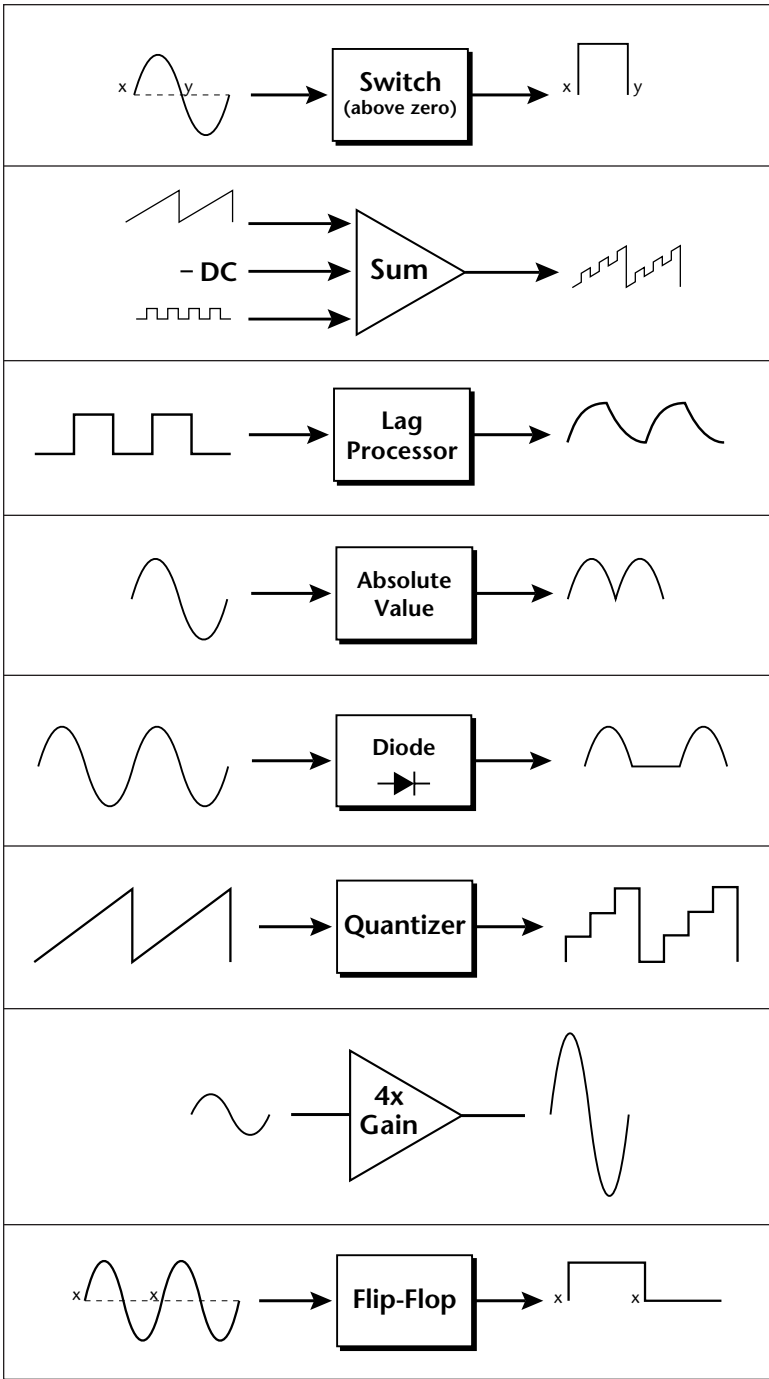

Modulation Processors

Modulation processors are inserted into a modulation routing as shown in the diagram below.

The modular analog synthesizers of yesteryear were incredibly flexible, partly because processing devices could be connected in any order. Modulation processors are designed according to this modular concept. They can be linked and used in a wide variety of ways limited only by your imagination. Consider the following example:

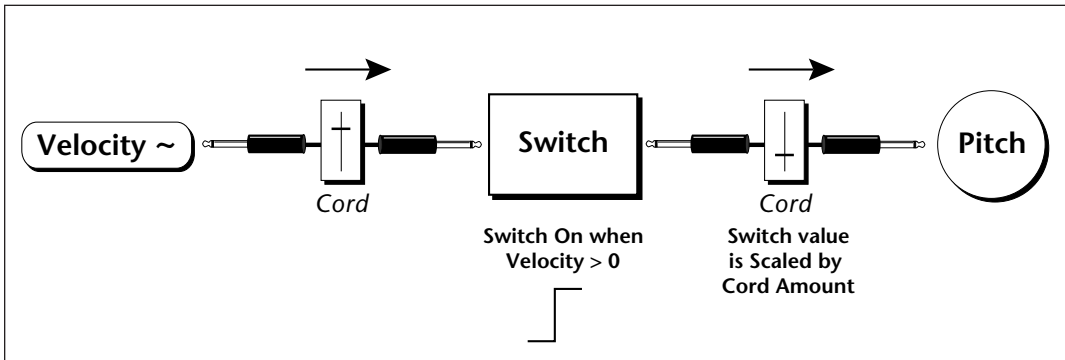

This patch would be programmed in the Cords screen as shown below.

Cords 00 to 05			[A] EDITING 5 VOICES: A-1:C7		
source	dest	amount	source	dest	amount
00: Vel~	Switch	+100%	03: Off	Off	+13%
01: Switch	Pitch	+22%	04: Off	Off	+36%
02: Off	Off	+0%	05: Off	Off	+0%

Utils [Tuning Amp/Filt Lfo/Aux **Cords**] Zoom

This particular patch shifts the overall pitch up a fifth when the key velocity exceeds 64. Velocities below 64 will play at normal pitch and velocities of 64 and above will be raised a perfect fifth. The Velocity “~” source scales the played velocity around zero. In other words, low velocities (below 64) will have negative values and high velocities (64 and above) will be positive. A velocity of 64 would be zero. The **Switch** module only outputs a “1” if the input value is greater than zero. This digital “1” value can be scaled through the attenuator on the patchcord to raise or lower the pitch by any amount. In this case, a scaling value of +22 raises the pitch by a perfect fifth. The amount of the

patchcord on the input to the switch is unimportant because ANY velocity value equal or greater than 64 will flip the switch. If the input cord amount were a negative value however, the action of the velocity would be reversed and velocities less than 64 would raise the pitch and velocities equal or greater than 64 would play the original pitch.

But what if you wanted the velocity switch point to be something other than 64? Thanks to the modulation processors, it can be done. Here's how.

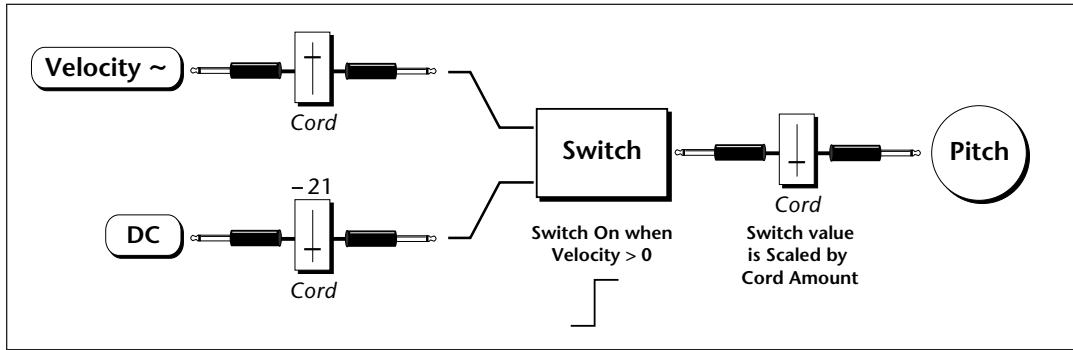

Connect the DC level to the input of the switch along with the velocity value. **Note that more than one modulation source can be applied to the input of a processor.**

The value of the DC offset determines the velocity switch point and is adjusted using the patchcord's attenuator. By setting the DC amount to a negative amount, higher velocity values are required to trip the switch. Setting the DC value to a positive value would bring the velocity switch point down.

The Cords screen for this patch is shown below.

Cords 00 to 05			[A] EDITING 5 VOICES: A-1-C7				
#	source	dest	amount	#	source	dest	amount
00:	Vel~	Sum	+100%	03:	Switch	Pitch	+22%
01:	DC	Sum	-21%	04:	Off	Off	+0%
02:	Sum	Switch	+100%	05:	Off	Off	+0%

Another example routes the Pink Noise generator through one of the Lag Processors in order to derive a smooth random function. A smooth random wave is useful in small amounts to add a degree of natural variation to timbre when routed to filter cutoff. Normal pink noise is low pass filtered audio frequency noise with a 3 dB/octave slope to give equal energy per octave. E4K pink noise is actually more like very low frequency filtered (mauve) noise, but it is perfect for use as a random control source.

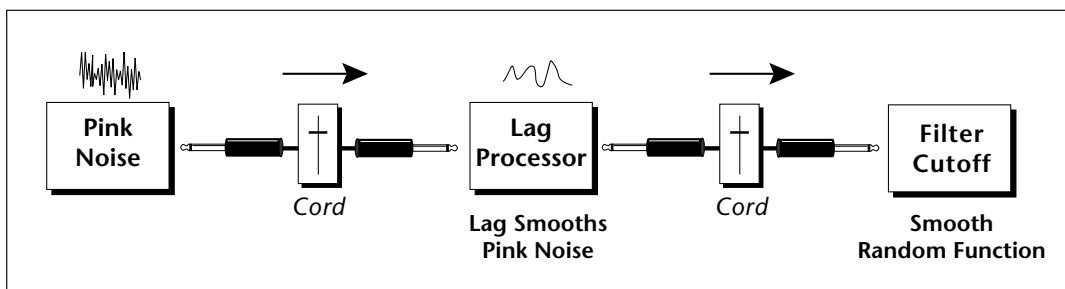

The **Quantizer** can generate interesting whole-tone scales when envelope generators or LFOs are routed to the input. The quantizer turns a smoothly changing input signal into a series of steps. By routing the output of the quantizer to Pitch and adjusting the cord amounts, you can control both the number of steps and the pitch interval of each step.

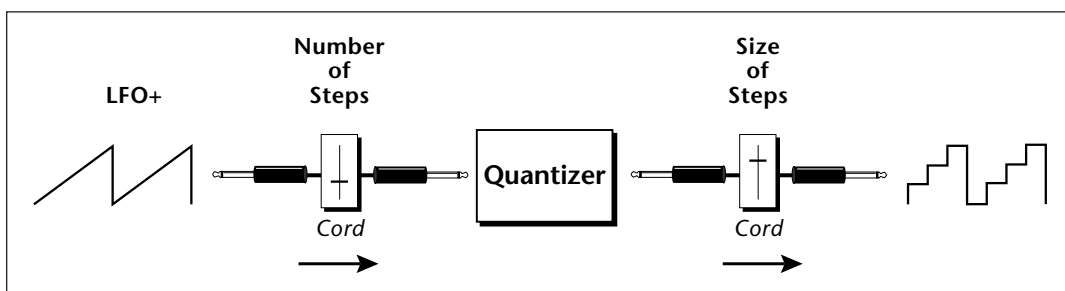

The input cord amount controls how many steps will be generated. With a sawtooth wave (LFO+) feeding the input and the cord amount set to 100%, sixteen steps will be generated. The output cord amount controls the size (or interval) of the steps.

Try setting up the following patch exactly as shown below using your favorite preset as a starting point.

LFO 1 [M] V1: A-1-C7

Rate : 0.35 Sync: key sync

Shape : sawtooth

Delay : 0

Variation: 0%

[Utils] [Tuning Amp/Filt Lfo/Aux Cords]

Cords 00 to 05 [M] V1: A-1-C7

source	dest	amount	source	dest	amount
00: Lfo1 +	Quantize	+100%	03: Off	Off	+0%
01: Quantiz	Pitch	+100%	04: Off	Off	+0%
02: DC	Pitch	-50%	05: Off	Off	+0%

[Utils] [Tuning Amp/Filt Lfo/Aux Cords] [?/000]

Tip: The 4x Amp can be used to get more steps or increase the interval of the quantizer.

This patch generates an ascending arpeggio every time a key is pressed. The block diagram of the patch is shown below. The patch is very straightforward except for the DC offset which was added in to bring the pitch down into tune. (Sometimes you have to fix a problem, but using the mod procesors there's usually a way around it to achieve the desired result.)

Tip: Experiment with this patch by connecting other sources and destinations to the quantizer.

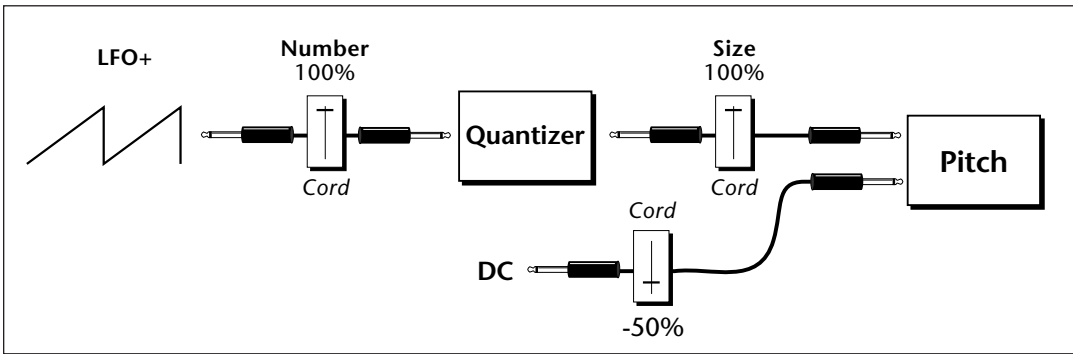

You can probably start to see some of the possibilities (and there are many). Whenever you find yourself wishing for some esoteric type of control, take a minute and think if there is a way to achieve the desired result using the modulation processors.

BACKGROUND: Dynamic Filter

The block diagram of the signal path is shown below.

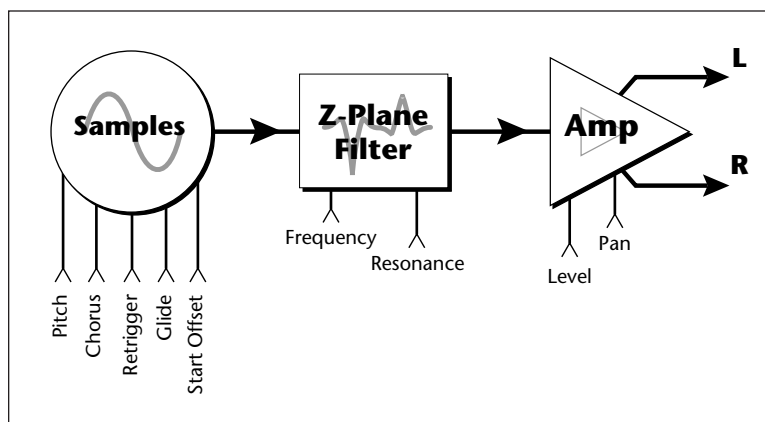

A *Low Pass* filter is a powerful synthesizer filter which can dramatically alter the sound of a sample.

To understand how a filter works, we need to understand what makes up a sound wave. A sine wave is the simplest form of sound wave. Any waveform except a sine wave can be analyzed as a mix of sine waves at specific frequencies and amplitudes.

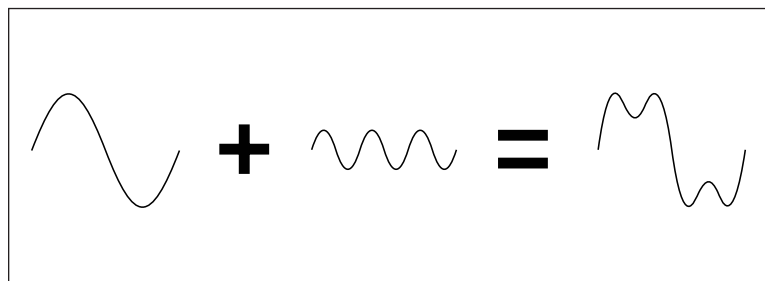

Any waveform can be analyzed as a mixture of sine waves.

One way to represent complex waveforms is to use a chart with frequency on one axis and amplitude on the other. Each vertical line of the chart represents one sine wave at a specific amplitude and frequency.

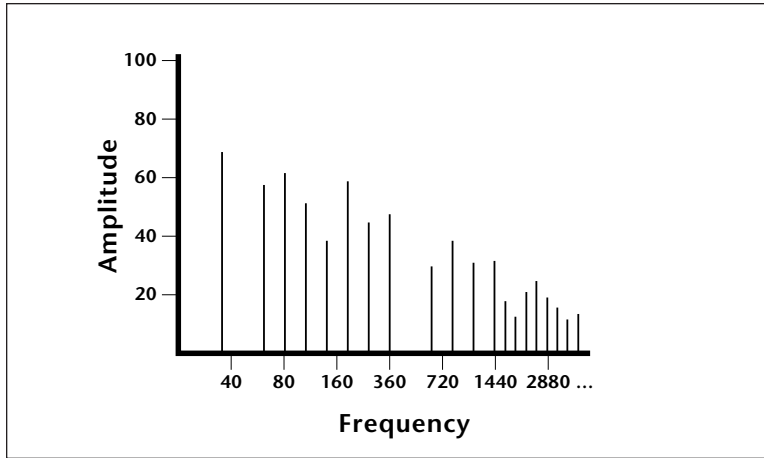

WHAT IS A FILTER?

Most samples are complex waves containing many sine waves of various amplitudes and frequencies. A **filter** is a device which allows us to remove certain components of a sound depending on its frequency. For example, a *Low Pass Filter* lets the *low frequencies pass* and removes only the high frequencies.

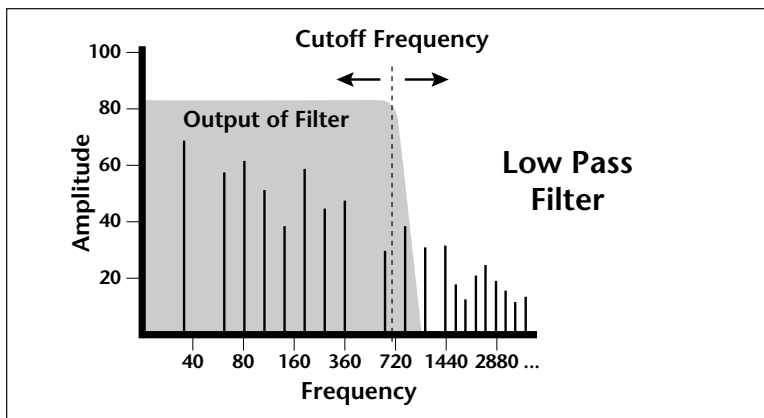

A filter that lets only the high frequencies pass is called a *High Pass Filter*.

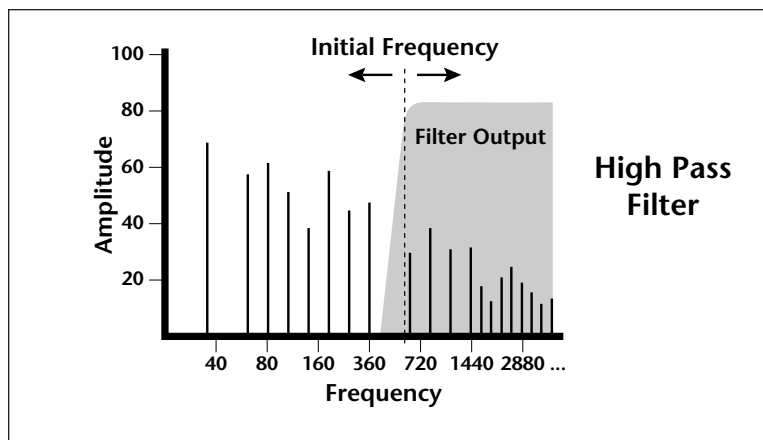

A filter which only lets a certain band of frequencies pass is called a *Bandpass Filter*.

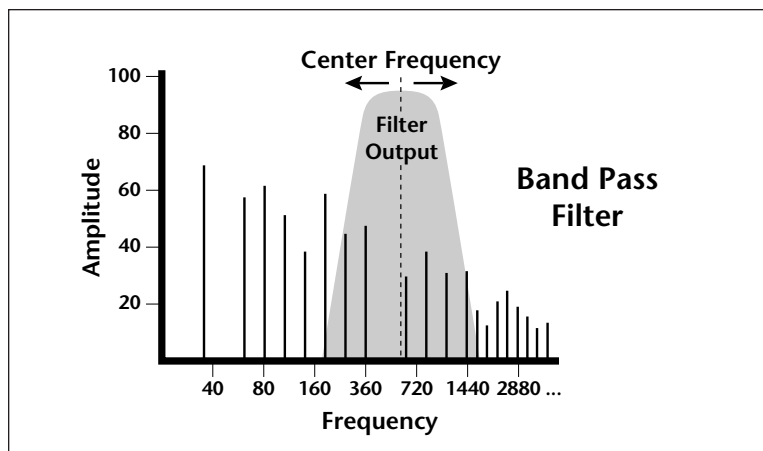

A *Notch Filter* is just the opposite of a bandpass filter and is used to eliminate a narrow band of frequencies.

Another control found on traditional filters is called Q or resonance. A lowpass filter with a high Q would emphasize the frequencies around the cutoff frequency. The chart below shows how different amounts of Q affect the low pass filter response. In terms of sound, frequencies around the

cutoff will tend to “ring” with high Q settings. If the filter is slowly swept back and forth, with a high Q, various overtones will be “picked out” of the sound and amplified as the resonant peak sweeps over them. Bells and gongs are real world examples of sounds which have a high Q.

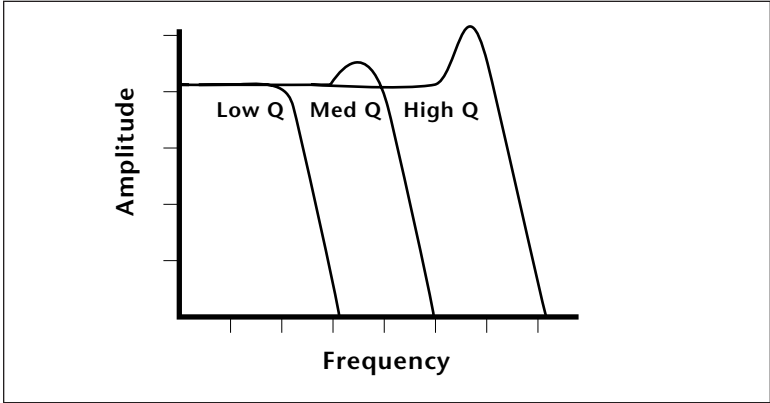

Another characteristic of a filter is the number of poles it contains. Traditional synthesizer filters were usually either 2-pole or 4-pole filters. The E4K has a selectable 2, 4 or 6-pole low pass filter. The number of poles in a filter describes the steepness of its slope. The more poles, the steeper the filter's slope and the stronger the filtering action. The tone controls on your home stereo are probably one-pole or two-pole filters. Parametric equalizers are usually either two-pole or three-pole filters. In terms of vintage synthesizers, Moog and ARP synthesizer filters used 4-pole filters, Oberheim synthesizers were famous for their 2-pole filter sound.

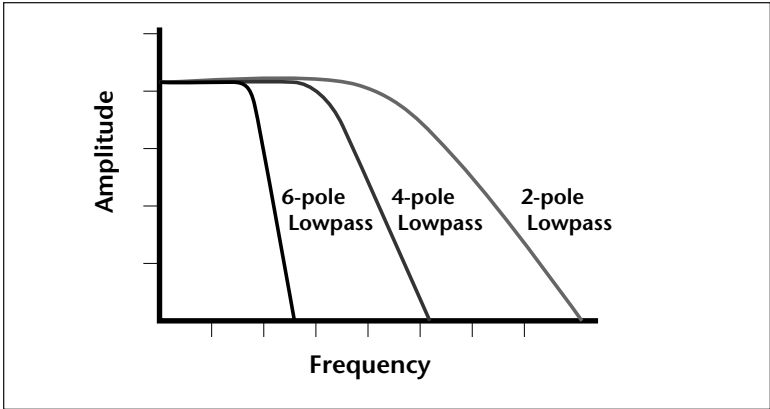

Using a filter, we now have a way to control the harmonic content of a sampled sound. As it turns out, even a simple low pass filter can simulate the response of many natural sounds.

For example, when a piano string is struck by its hammer, there are initially a lot of high frequencies present. If the same note is played softer, there will be fewer of the high frequencies generated by the string. We can simulate this effect by routing keyboard velocity to control the low pass filter. The result is expressive, natural control over the sound.

If an envelope generator is used to control the cutoff frequency of a filter, the frequency content can be varied dynamically over the course of the note. This can add animation to the sound as well as simulate the response of many natural instruments.

PARAMETRIC FILTERS

A more complex type of filter is called a parametric filter or **Swept EQ**. A parametric filter allows control over three basic *parameters* of the filter. The three parameters are: *Frequency*, *Bandwidth*, and *Gain*. The Frequency parameter allows you to select a range of frequencies to be boosted or cut, the Bandwidth parameter allows you to select the width of the range, and the Gain parameter either boosts or cuts the frequencies within the selected band by a specified amount. Frequencies not included in the selected band are left unaltered. This is different from a band pass filter which attenuates (reduces) frequencies outside the selected band.

Another parameter sometimes used on a parametric filter is *Shelving*. Shelving simply widens the passband so that it extends to the limit of the upper or lower frequency range.

The parametric filter is quite flexible. Any range of frequencies can be either amplified or attenuated. Several parametric sections are often cascaded in order to create complex filter response curves.

THE Z-PLANE FILTER

A Z-plane filter is a filter which can change its function over time. In a Z-plane filter, we start with two complex filter types and interpolate between them using a single parameter. Refer to the diagram on the following page.

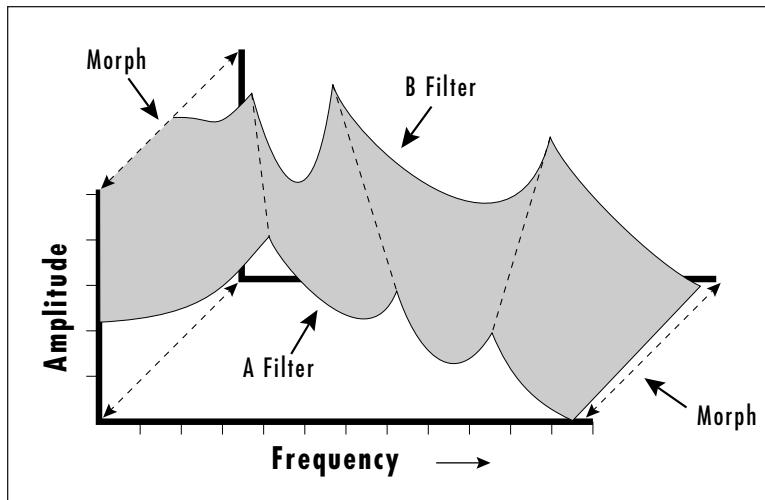

The Z-plane filter has the unique ability to change its function over time.

Filters A and B represent two different complex filters or “frames”. By changing a single parameter, the **Morph**, many complex filter parameters can now be changed simultaneously. Following along the Morph axis you can see that the filter response smoothly interpolates between the two filters. This is the essence of the Z-plane filter. Through the use of interpolation, many complex parameters are condensed down into one manageable entity.

Consider, as an example, the human vocal tract, which is a type of complex filter or resonator. There are dozens of different muscles controlling the shape of the vocal tract. When speaking, however, we don't think of the muscles, we just remember how it feels to form the vowels. A vowel is really a configuration of many muscles, but we consider it a single object. In changing from one vowel to another, we don't need to consider the frequencies of the resonant peaks! You remember the shape of your mouth for each sound and **interpolate** between them.

This Z-plane filter sweep can be controlled by an envelope generator, an LFO, modulation wheels or pedals, keyboard velocity, key pressure, etc. In fact, any of the modulation sources can control the Z-plane filter.

BACKGROUND: Selecting Voices, Samples & Groups

Voices-Main			volume	pan	ctune	ftune	xpost	orig
V6	G1	S006 Piano Ab2	-16	+0	+0	+0	+0	g#2
V7	G1	◆multisample◆	+0	+0	+0	+0	+0	
		S007 Piano Db3	-16	+0		+0		c#3
		S007 Piano Db3	-16	+0		+0		c#3

Utils [SZone] [Global Links **Voices 1** EditYce

When working on complex sounds we need an easy way to specify certain voices or groups of voices for editing. As usual, the E4K gives you several ways to select Voices Samples and Groups.

Selecting from the Preset Editor Windows

To select Voices, Groups, or Samples from any of the preset editor windows you simply move the cursor to the appropriate field and press the **Edit** key (F6). The label on the Edit key will change depending on which type of item the cursor is on.

- When the cursor is on any **Voice-related Function**, the Edit key will select **Voice Edit**.
- When the cursor is on the **Group Number**, the Edit key will select the entire **Group**.
- When the cursor is on the **Sample Name**, the Edit key will select the **Sample** and will automatically jump into the Sample Edit menu.

There are also a couple of other little tricks to help you select voices from the Preset Editor Windows.

- **Press and Hold the decimal point key** while playing a keyboard key to select that voice. Repeatedly pressing the keyboard key will rotate through any other voices assigned to that same key.
- **Press and Hold the decimal point key** and use the data entry control or inc/dec keys to select voices.

Selecting All Voices

In many cases, you will want to select the entire keyboard. An easy way to select all is to go to the Preset Globals page.

1. Press **Preset Edit**
2. Press **Global** (F3).
3. Press **Edit All** (F6). You have just selected all voices.

Selecting Voices from the Dynamic Processing Level

For E4K power users, there is an automatic voice selection mode which selects voices whenever you play the keyboard.

To turn Automatic Voice Selection On:

1. Press **Preset Edit**
 2. Press **Edit** (F6).
 3. Press **Utils** (F1).
 4. Press **VSelect** (F1).
 5. Press **Auto** (F3).
 6. Press **OK** (F6).
- Selecting a single note will select all voices assigned to that key.
 - Selecting a keyboard range by pressing two notes at once will select all voices within that range.

Now a word of caution: When you play the keyboard to hear the results of your edit, **YOU ARE CHANGING THE VOICE SELECTION RANGE!** This can be confusing unless you remember to re-key the voice selection range before resuming editing.

Selecting Voices from the Voice Select Screen

There is also a special Voice Selection screen located in the Utilities menu of the Dynamic Processing level. For detailed explanations of the different voice selection options see page 303. To get to the Voice Select screen do the following:

1. Press **Preset Edit**
2. Press **Edit** (F6).
3. Press **Utils** (F1).
4. Press **VSelect** (F1).

BACKGROUND: Groups

Uces-KyWin				low	fade	high	fade	C-2	C0	C2	C4	C6	CB
V1	G1	S001 Piano	C-2	0	a#2	0							
V2	G1	S002 Piano	B2	0	C7	0							
V3	G2	S003 Piano	C-2	0	a#2	0							

Tip: Get in the habit of grouping your voices. It makes selection of different layers so easy.

Dealing with a number of voices arranged on the keyboard can sometimes be a bit overwhelming. You might find yourself wishing there was a way to organize similar voices, say a layer of piano voices and a layer of string voices, into unified entities or **Groups**. That's it, groups!

To place a voice into a group, you simply tag each voice you want to be in the group with the same group number. Then, whenever you select that group number in the voice selection screen, all voices with that group number will be selected. You can define up to 32 groups, but a voice can only be in one group at a time.

Groups are assigned in any of the voice windows. In the Key Window shown above, two voices (1 & 3) are assigned to the same key range or in other words, they are layered. Note that they are also in two different groups. If you wanted to select voices 1 and 2, you could simply move the cursor to the **Group 1** field in the key window shown above. The Edit key changes to read, "EditGrp". Simply press the EditGrp key (F6) to select all voices in group 1.

BACKGROUND: Preset Editor

The Preset Edit module puts everything together to build complete presets. Samples can be arranged into single-sample or multi-sample voices with synthesizer processing applied. These complete voices can then be arranged on the keyboard.

The E4K Preset Editor contains two levels. The top level, called **Preset Definition**, is used for editing global preset parameters, linking presets and for arranging voices and samples on the keyboard. The lower level, called **Dynamic Processing**, is used to perform more detailed editing of one or more preset voices such as envelope shaping of amplitude and filters as well as modulation parameters.

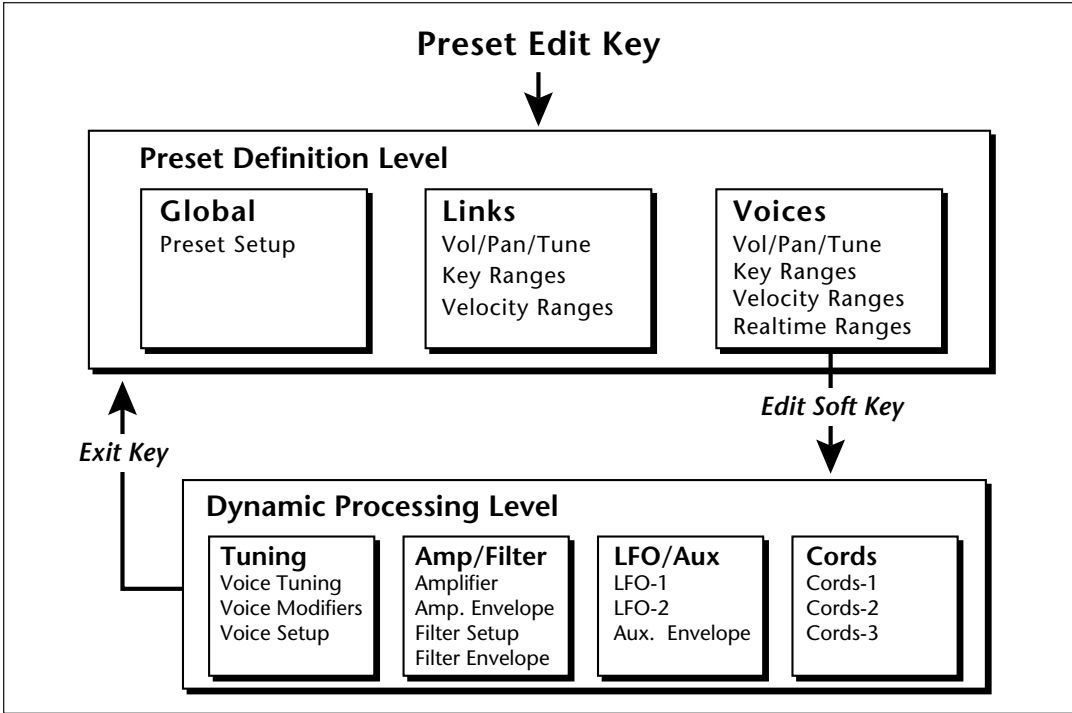

The dynamic processing parameters are accessed by pressing the **Edit** soft key while in one of the Voice screen parameters (or directly via an assignable key). Multiple voice selection is supported in any of the Dynamic Processing editing screens using a MIDI keyboard (Auto Voice Select).

The Preset Definition level contains three main pages (Global, Links, Voices) which are selected using a soft key. Each page will be highlighted while it is selected.

Tip: *The Preset Editor remembers which page was last displayed and returns to that same page when the Preset Edit key is again pressed. When the EXIT key is pressed, while in any Dynamic Processing editor screen, the last-displayed Preset Editor screen will reappear (unless the preset is changed).*

- **Global Editor** - Contains the parameters Preset Transpose and Preset Volume which affect all voices in the preset.
- **Links** - Call up other presets in the bank which can be used to create layering or keyboard splits. Linked presets are not altered by linking. They are simply called up from memory and played. **An easy way to layer, crossfade or split sounds is to link presets in an empty preset.** See *New Link*. Each linked preset can have its own keyboard range, velocity range, volume, pan position, and tuning.
- **Voice Editing** - Allows you to place voices and samples on the keyboard and crossfade or switch between them according to key position, velocity range and realtime control range. This submodule also contains parameters to adjust the tuning, volume and pan position for the voices and samples.

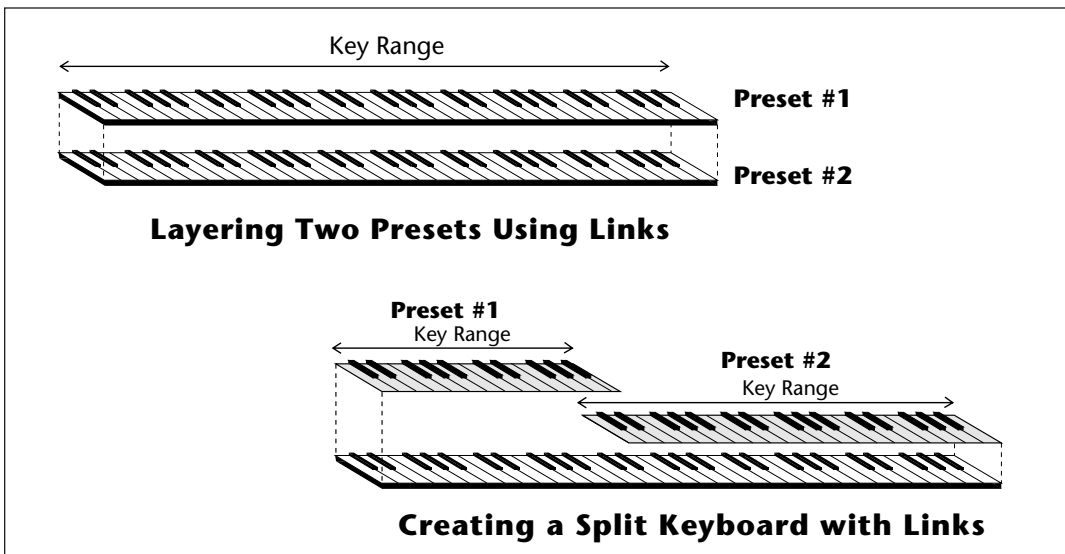

If a voice contains more than one sample, it will be labeled as a multisample and the individual samples will be listed below it. Voices are shown graphically as solid black bars and samples are shown as empty bars. If a voice contains only one sample, then the sample will be the voice name.

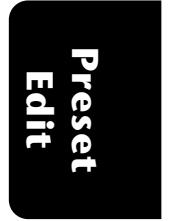

PRESET EDIT - Global

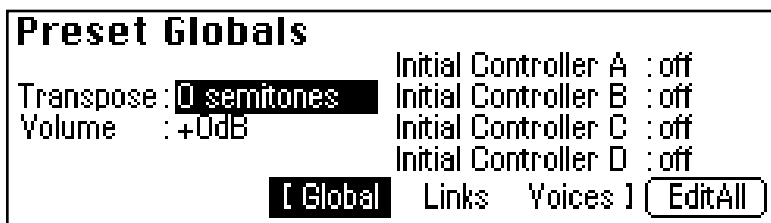

GLOBAL EDITOR

- **Transpose & Volume:** These are global parameters which affect the entire preset.
- **Initial Controllers A-D:** These set the initial value of the front panel realtime control sliders. As soon as a slider is moved, it jumps immediately from the initial setting to the actual setting of the slider.

► To Change the Global Parameters:

1. Press the **Preset Edit** key. The LED will illuminate and the main preset edit screen will appear.
2. Press the **Global** function key (F3). The preset global page will appear.
3. Adjust the **Volume** and **Transpose** interval for the preset.
4. Set up the initial realtime slider settings for the preset.
5. Press the **Links** or **Voices** soft keys to continue in Preset Edit or press the **Preset Edit** key to exit the module.

► EDIT ALL

The Edit All soft key selects all voices and jumps immediately into the dynamic processing level of the voice editor.

This key is the fastest way into the editor when you want to work on all voices at once.

Preset Effects A

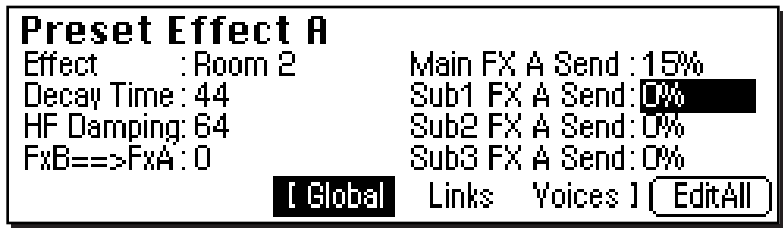

The Preset Effects settings are normally used whenever the E4K is in Omni or Poly mode. This allows the effects to be programmed as part of the preset. Because there are only two effects processors for the entire machine, effects cannot be programmed separately for each preset in Multimode.

If the Effect parameter is set to “Master Effect”, the effects setting in the Master module is used. This system allows the effects to be assigned per preset or globally for all presets. There are two effect processors Effect “A” and Effect “B”. “A” type effects consist mainly of reverbs.

The Preset Effects are accessed from the Preset Global submenu by pressing the Next key.

EFFECTS PROGRAMMED IN THE PRESET

When playing single presets the effects are normally programmed as part of the preset.

► To Program the Effects as part of the Preset:

1. Press the Preset Edit key. The LED will illuminate and the Preset Edit screen will appear.

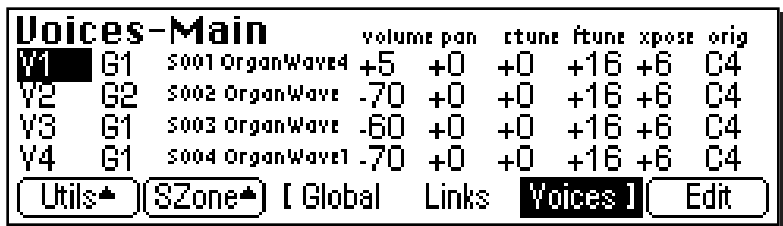

Tip: Effects can be programmed in the Preset or in the Master module. The Controls/FX Key remembers which effects menu you visited last and jumps there.

Pressing the Controls/FX key again toggles between the FX A and FX B menus.

- If you are in a screen where the “Global, Links, Voices” soft-keys are not visible, press the Exit key once.
2. Press the **Global** function key (F3). The Global menu will appear.
 3. Press the Next page key. The Preset Effect A menu will appear.

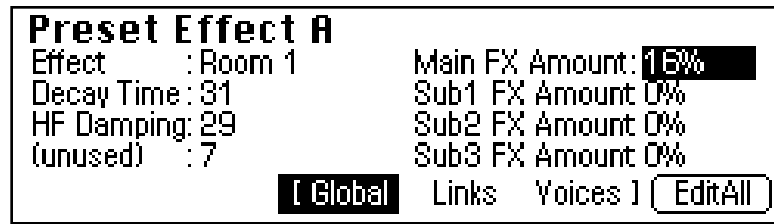

4. Select an Effect. Do not use the “Default” setting as this will cause the Master effect settings to be used. Set the other effect parameters to your preference.
5. Press the Next page key again to go to the Preset Effect B menu.
6. Save the bank. The programmed effects settings will be saved along with the preset.

EFFECT

This function selects the type of effect used. The following effects are currently available:

► A EFFECT TYPES

Room 1-3	Bright Plate
Hall 1 & 2	B-Ball Court
Plate	Gymnasium
Delay	Cavern
Panning Delay	Concert 9
Multitap 1	Concert 10 Pan
Multitap Pan	Reverse Gate
3 Tap	Gate 2
3 Tap Pan	Gate Pan
Soft Room	Concert 11
Warm Room	Medium Concert
Perfect Room	Large Concert
Tiled Room	Large Concert Pan
Hard Plate	Canyon
Warm Hall	DelayVerb 1-3
Spacious Hall	DelayVerb 4-5 Pan
Bright Hall	DelayVerb 6-9
Bright Hall Pan	

► To Change the Effect Type:

1. Press the **Preset Edit** key. The LED will illuminate and the Preset Edit screen which was last used will appear.
2. Press the **Global** function key (F3). The Preset Globals menu will appear.
3. Press the **Next** page key. The Effects A menu will appear.
4. Move the cursor to the Effect field using the cursor keys.
 - **Alternate Method:** The **Controls** key will jump to the the Effects menu (either Master FX or Preset FX) that you used last. Press the Controls key again to toggle between the A and B effects.

5. Select the desired effect type using the data entry control, or inc/dec keys.
6. Press the **Exit** key to return to the main screen.

DECAY TIME

This parameter sets the length of time it will take an effect to fade away. In the case of reverb, decay time controls the room size and the reflectivity of the room. On a delay effect, decay time controls how many echoes are produced or how long the echoes will last.

► To Change the Decay Time:

1. Press the **Preset Edit** key. The LED will illuminate and the Preset Edit screen which was last used will appear.
2. Press the **Global** function key (F3). The Preset Globals menu will appear.
3. Press the **Next** page key. The Effects A menu will appear.
4. Move the cursor to the Decay Time field using the cursor keys.
5. Set the decay time using the data entry control, or inc/dec keys.
6. Press the **Exit** key to return to the main screen.

HF DAMPING

High frequency energy tends to fade away first as a sound is dissipated in a room. This parameter allows you adjust the amount of high frequency damping and thus change the characteristics of the room. Rooms with smooth, hard surfaces are more reflective and have less high frequency damping. Rooms filled with sound absorbing materials such as curtains or people have more high frequency damping.

► To Change the High Frequency Damping:

1. Press the **Preset Edit** key. The LED will illuminate and the Preset Edit screen which was last used will appear.
2. Press the **Global** function key (F3). The Preset Globals menu will appear.
3. Press the **Next** page key. The Effects A menu will appear.

4. Move the cursor to the HF Damping field using the cursor keys.
5. Adjust the HF Damping parameter using the data entry control, or inc/dec keys.
6. Press the **Exit** key to return to the main screen.

FX AMOUNTS

The Effects Amount controls the percentage of effected (wet) signal to un-effected (dry) signal. This function would be analogous to the effects return on a mixing console. The effects amount for each of the four stereo outputs can be individually controlled.

► To Change the Effects Amount:

1. Press the **Preset Edit** key. The LED will illuminate and the Preset Edit screen which was last used will appear.
2. Press the **Global** function key (F3). The Preset Globals menu will appear.
3. Press the **Next** page key. The Effects A menu will appear.
4. Move the cursor to the desired FX Amount field using the cursor keys.
5. Adjust the FX Amount using the data entry control, or inc/dec keys.
6. Press the **Exit** key to return to the main screen.

Preset Effects B

Preset Effect B		
Effect	: Chorus 5	Main FX B Send : 0%
Feedback	: 64	Sub1 FX B Send: 0%
LFO Rate	: 2	Sub2 FX B Send: 0%
Delay Time	: ---	Sub3 FX B Send: 0%
[Global Links Voices] <input type="button" value="EditAll"/>		

The Preset Effects settings are normally used whenever the E4K is in Omni or Poly mode. This allows the effects to be programmed as part of the preset. Because there are only two effects processors for the entire machine, effects cannot be programmed separately for each preset in Multimode.

If the Effect parameter is set to "Master Effect B", the effects settings in the Master module are used and the parameters in the Preset Effects become unavailable. This system allows the effects to be assigned per preset or globally for all presets. "B" type effects consist mainly of chorus, flange and digital delay effects.

The Preset Effects B are accessed from the Preset Global submenu by pressing the Next key twice.

*** Tip:** Effects can be programmed in the Preset or in the Master module. The Controls/FX Key remembers which effects menu you visited last and jumps there.

Pressing the Controls/FX key again toggles between the FX A, FX B and Preset Globals menus.

EFFECT

This function selects the type of effect used. The following effects are currently available:

► B EFFECT TYPES

Chorus 1-5	Delay Stereo
Doubling	Panning Delay
Slapback	Delay/Chorus
Slap FB	Pan Delay Chorus
Flange 2-7	Dual Tap 1/3
Big Chorus	Dual Tap 1/4
Symphonic	Vibrato
Ensemble	Symphonic
Delay	

► **To Change the Effect Type:**

1. Press the **Preset Edit** key. The LED will illuminate and the Preset Edit screen which was last used will appear.
2. Press the **Global** function key (F3). The Preset Globals menu will appear.
3. Press the **Next** page key twice. The Effects B menu will appear.
 - **Alternate Method:** The **Controls** key will jump to the the Effects menu (either Master FX or Preset FX) that you used last. Press the Controls key again to toggle between A and B effects.
4. Move the cursor to the Effect field using the cursor keys.
5. Select the desired effect type using the data entry control, or inc/dec keys.
6. Press the **Exit** key to return to the main screen.

 **Tip:** See chapter 4, *FX/Sequencer* for detailed information on the effects.

FEEDBACK AMOUNT

The Chorus and Flange effects have a controllable feedback loop after the delay element. By feeding back a small amount of the signal intensifies the effect by creating multiple cancellations or images.

► **To Change the Feedback Amount:**

1. Press the **Preset Edit** key. The LED will illuminate and the Preset Edit screen which was last used will appear.
2. Press the **Global** function key (F3). The Preset Globals menu will appear.
3. Press the **Next** page key twice. The Effects B menu will appear.
4. Move the cursor to the desired Feedback Amount field using the cursor keys.
5. Adjust the Feedback Amount using the data entry control, or inc/dec keys.
6. Press the **Exit** key to return to the main screen.

LFO RATE

Chorus and flange effects use a Low Frequency Oscillator to animate the effect. LFO applied to a chorus effect creates the slight changes necessary for a realistic choral effect. Applied to a flanger, the LFO moves the comb filter notches and adds animation to the sound.

► To Change the LFO Rate:

1. Press the **Preset Edit** key. The LED will illuminate and the Preset Edit screen which was last used will appear.
2. Press the **Global** function key (F3). The Preset Globals menu will appear.
3. Press the **Next** page key twice. The Effects B menu will appear.
4. Move the cursor to the **LFO Rate** field using the cursor keys.
5. Set the **LFO Rate** using the data entry control, or inc/dec keys.
6. Press the **Exit** key to return to the main screen.

DELAY TIME

Flanging, chorus and echoes are all based on a delay line where the signal is delayed by some time period and mixed back together with its un-delayed signal. This parameter varies the length of the delay or “how much time” passes before you hear the delayed signal. On some effects, this parameter is not adjustable, indicated by a dash in the field.

► To Change the Delay Time:

1. Press the **Master** key. The LED will illuminate and the Memory Statistics screen will appear.
2. Press the **Output** function key (F4). The Output menu will appear.
3. Press the **Next** page key twice. The Effects B menu will appear.
4. Move the cursor to **Delay Time** using the cursor keys.
5. Adjust the **Delay Time** parameter using the data entry control, or inc/dec keys.
6. Press **Exit** to return to the main screen.

FX AMOUNTS

The Effects Amount controls the percentage of effected (wet) signal to un-effected (dry) signal. This function would be analogous to the effects return on a mixing console. The effects amount for each of the four stereo outputs can be individually controlled.

► To Change the Effects Amount:

1. Press the **Preset Edit** key. The LED will illuminate and the Preset Edit screen which was last used will appear.
2. Press the **Global** function key (F3). The Preset Globals menu will appear.
3. Press the **Next** page key twice. The Effects B menu will appear.
4. Move the cursor to the desired FX Amount field using the cursor keys.
5. Adjust the **FX Amount** using the data entry control, or inc/dec keys.
6. Press the **Exit** key to return to the main screen.

PRESET EDIT - Links

Link Field

Link Preset name & number

Link Controls Volume, Pan, Coarse/Fine Tuning

Link	Link Preset name & number	volume	pan	xpose	ftune
L1	7008 Marcato Strings	+8	-13	+12	+0
L2	P011 Soft Flute	-4	-6	+0	+0
L3	P030 Ac. Guitar	+3	+3	+0	+0
L4	P006 Breathy Voices	-11	+11	+0	+0

Utils [Global Links Voices]

Displays Global Editor Pages

Displays Voice Editor Pages

New - adds link to preset
Delete - deletes link from preset
Copy - copies link to any preset
Subsume - copies voices of the linked preset into the current preset.

Button is highlighted while this page set is displayed.

PAGE

PREV NEXT

Use the Page keys to access the Key & Velocity windows.

Tip: See Voice Tuning in this chapter for detailed explanations of the Volume, Pan and Tuning controls.

MAIN CONTROLS

- **Link Field:** Link can be selected using the numeric keypad or data entry control.
- **Link Preset Name & Number:** The linked preset can be changed using the data entry control or inc/dec keys.
- **Link Controls:** These controls offset the volume, pan, transpose and fine tuning controls of the linked preset.
- **Utilities:** New, Delete, Copy, and Subsume.

Utilities

NEW LINK

Creates a new link field.

► To Create a New Link:

1. Press the **Preset Edit** key. The LED will illuminate and the last page selected will appear.
2. Press the **Links** soft key (F4) to select the link page of the editor. The link soft key will be highlighted.
3. Press the **Utils** function key (F1). A second row of soft keys will appear.
4. Press the **New...** function key (F1). A new link field will be added to the list of preset links.
5. Press **Exit** if you wish to cancel the operation.

► Create a Huge Stacked Preset the Easy Way:

1. Load any bank of presets.
2. Press the **Preset Manage** key. Press the **New** key to create a new blank preset.
3. Select a location for the new blank preset and name it if desired. Press the **Preset Edit** key.
4. Press the **Links** soft key (F4) to select the link page of the editor. The link soft key will be highlighted.
5. Press the **Utils** function key (F1). A second row of soft keys will appear.
6. Press the **New...** function key (F2). A new link field will be added to the list of preset links.
7. Move the cursor to the preset field and select a preset.
8. Repeat steps 6 and 7 until the desired thickness has been achieved.
9. Press **Exit** to leave the Utilities menu.

COPY LINK

Copies a link and its parameters to and from any preset.

► To Copy a Link:

1. Press the **Preset Edit** key. The LED will illuminate and the last page selected will appear.
2. Press the **Links** soft key (F4) to select the link page of the editor. The link soft key will be highlighted.
3. Select the Link you wish to copy using the up/down cursor keys or the data entry control when the link field is selected.
4. Press the **Utils** function key (F1).
5. Press the **Copy** function key (F4). The pop up dialog box shown below will appear.

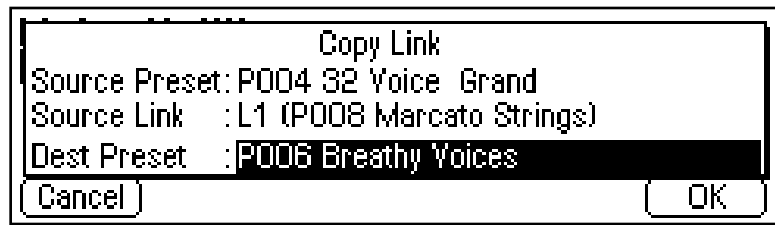

6. Select the source and destination presets as well as the source link to be copied.
7. Press **OK** to copy the link or **Cancel** to cancel the operation.

DELETE LINK

Removes the selected link field.

► To Delete a Link:

1. Press the **Preset Edit** key. The LED will illuminate and the last page selected will appear.
2. Press the **Links** soft key (F4) to select the link page of the editor. The link soft key will be highlighted.
3. Select the Link you wish to delete using the up/down cursor keys or the data entry control when the link field is selected.

4. Press the **Utils** function key (F1). A second row of soft keys will appear.
5. Press the **Delete** function key (F3). A pop up dialog box will appear asking you to confirm the operation.
6. Press **OK** to delete the link or **Cancel** to cancel the operation.

SUBSUME LINK

Copies all the voices of the linked preset into the current preset.

► To Subsume a Linked Preset:

1. Press the **Preset Edit** key. The LED will illuminate and the last page selected will appear.
2. Press the **Links** soft key (F4) to select the link page of the editor. The link soft key will be highlighted.
3. Select the Link you wish to subsume using the up/down cursor keys or the data entry control when the link field is selected.
4. Press the **Utils** function key (F1). A second row of soft keys will appear.
5. Press the **Subsume** function key (F5). The pop up dialog box shown below will appear.

Tip: Use the *Subsume* function as another way to create presets.

1. Create a new preset.
2. Link the presets you want..
3. Subsume Link to pull all the voices into the current preset.

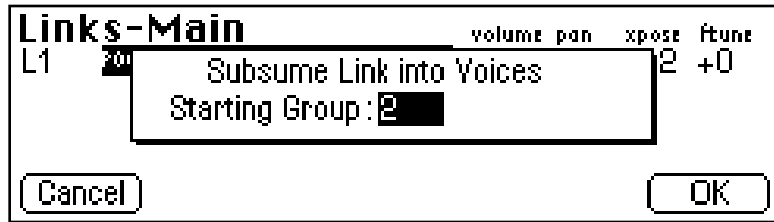

6. Select the Starting Group number. This will place the voices from the linked preset in groups beginning with the starting group number. If the voices in the linked preset were not grouped, they will all be placed into the starting group number.
7. Press **OK** to subsume the link or **Cancel** to cancel the operation.

Links - Key Window

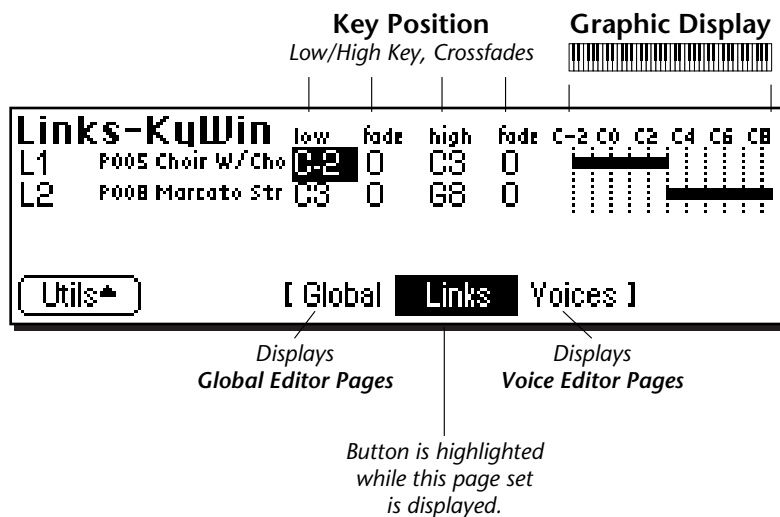

The Key Window of the Links screen is accessed by pressing the **Next Page** key on the front panel from the main Links screen. The screen shown above will appear. Note: If there are no links in the preset, the display will inform you of this fact. Press **Utilities**, then **New...** to create a new link.

KEY WINDOW CONTROLS

- **Link Field:** Link can be selected using the numeric keypad or data entry control.
- **Link Preset Name & Number:** The linked preset can be changed using the data entry control or inc/dec keys.
- **Key Position Controls:** These controls set the high and low key range and the crossfade range in keys for each linked preset.
- **Graphic Display:** Shows the keyboard positions of each link.
- **Utilities:** New, Delete, Copy, and Subsume.

KEYBOARD & VELOCITY RANGES

When editing the keyboard and velocity ranges of preset links, an editing screen similar to the one shown on the previous page will appear.

The bars at the right side of the screen give a graphic display of how the presets are placed on the keyboard. The key position is edited by placing the cursor over the desired parameter and then playing the MIDI keyboard or adjusting the data entry control.

► To Positionally Crossfade

The Fade parameters allow the volume of the preset to be faded out as a function of key position. In the Link screen shown below, the two presets are being positionally crossfaded over a range of one octave.

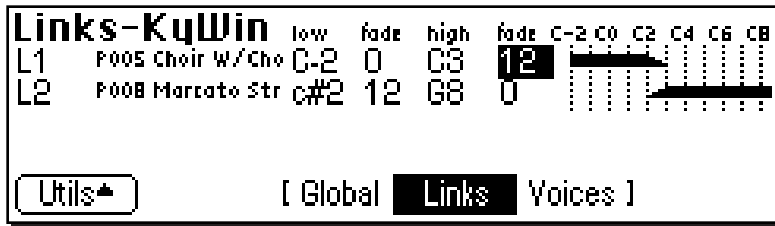

As you play up the keyboard in the C2-C3 octave range, the Choir preset will gradually fade out as the Marcato Strings fade in. This is illustrated on the display by the range bars fading out and in.

This technique can help mask the point at which two sounds meet. The presets are assigned so that they overlap by a few keys, then the fades are programmed so that one sound fades out as the other fades in.

Links - Velocity Window

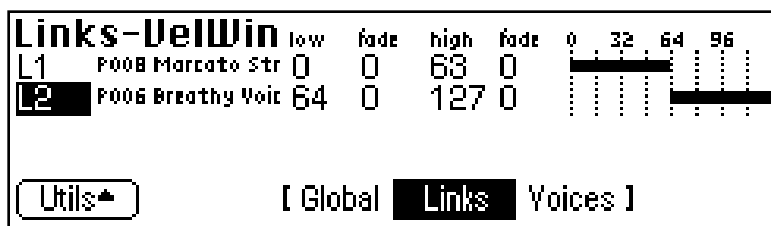

The Velocity Window of the Links screen is accessed by pressing the **Next Page** key on the front panel from the Key Window Links screen. A screen similar to the one shown above will appear. In the screen above, the two presets will be “velocity-switched” at a key velocity of 64.

VELOCITY WINDOW CONTROLS

- **Link Field:** The link can be selected using the numeric keypad or data entry control.
- **Link Preset Name & Number:** The linked preset can be changed from this window using the data entry control or inc/dec keys.
- **Velocity Controls:** These controls set the high and low key range and the crossfade range (in keys) for each linked preset.
- **Graphic Display:** Shows the velocity ranges of each link.

★ Caution: *If the key ranges do not overlap, you will not hear the effects of the velocity controls.*

Velocity Range

The Links - Velocity Range window allows you to control the volume of a preset using key velocity. You might want to switch or crossfade between a piano and string preset depending on the keyboard velocity, or switch between several percussion presets. Velocity switching between preset links makes it easy.

► **To Velocity-Switch Between Presets:**

To switch between two sounds according to velocity, their key ranges must first overlap. Normally you would set the *Key Ranges* so that they completely overlap one another, then set the *Velocity Ranges* so they are adjacent to each other.

For example, set one velocity range to 0-63 and the other to 64-127.

► **To Velocity Crossfade Between Presets:**

To crossfade between two presets, voices or samples according to velocity, their key ranges must overlap. Normally you will set the key ranges to the same range, as in the screen below.

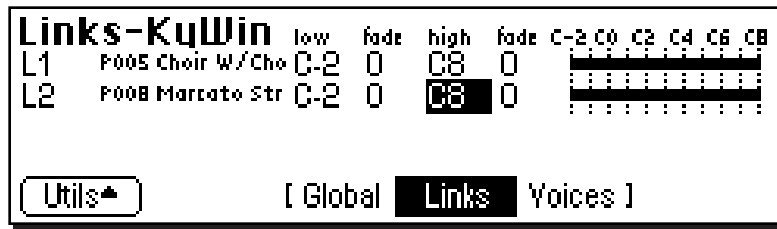

The default velocity range is from 0-127 or full range. Both presets will sound regardless of what velocity is played. Set the velocity range of each sound. The next screen shows the velocity ranges set so that preset link 1 fades out the higher the key velocity, while preset link 2 fades in, the higher the key velocity. At a velocity of 64, the two sounds will be equal volume.

Adjust the fade-in and fade-out points to achieve a natural sounding crossfade. The actual crossfade points will vary depending on the sounds.

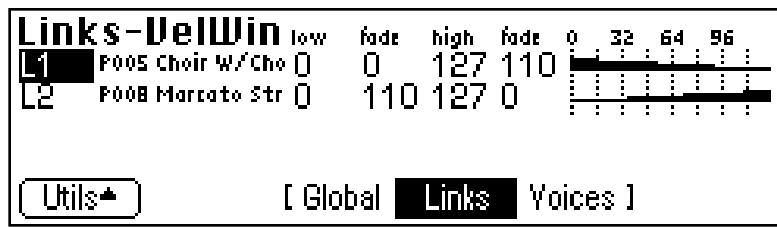

PRESET EDIT - Voices

Voice/Sample Name
or Multisample

Parameters
Volume, Pan, Coarse/Fine Tuning
Transpose, Original Key

Voice/Group Number —

Samples in Voice —

Voice/Group Number	Voice/Sample Name or Multisample	volume	pan	ctune	ftune	xpose	orig
Y7— G1	+multisample+	+0	+0	+0	+0	+0	
	S007 Piano Db3	-16	+0		+0		c#3
	S007 Piano Db3	-16	+0		+0		c#3
	S007 Piano Db3	-16	+0		+0		c#3

Buttons: [Utils] [SZone] [Global Links] **Voices** [EditVce]

New - adds a voice to the preset
Delete - deletes voice or sample zone from the preset
Copy - copies voice to any preset
Split - splits the voice into two

Displays **Global Editor Pages**

Displays **Link Editor Pages**

Button is highlighted while this page set is displayed.

New - Adds a new sample zone to the voice.
Get Multisample - Replaces only the multisamples in a voice.
Delete - Deletes a sample zone from the voice.
Combine - Creates one multisample from all the voices.
Expand - Creates individual voices from multisamples.

VOICES - MAIN CONTROLS

- **Voice/Group Number:** The voice can be selected using the numeric keypad, inc/dec keys, or data entry control. The group number can be *changed* in the same manner.
- **Samples:** The samples contained in the voice are displayed and can be edited.
- **Utilities**
- **Sample Zone Utilities**
- **Parameters:** Initial settings for volume, pan, coarse/fine tune, and transpose. The original key (where the actual sample is placed) can also be edited here.

Tip: See Voice Tuning in this chapter for detailed explanations of the Volume, Pan, Tuning and Transpose controls.

Utilities



Voices-Main			volume	pan	ctune	ftune	xpose	orig
V1	G1	S001 Piano E0	-16	+0	+0	+0	+0	E0
V2	G1	S002 Piano A0	-16	+0	+0	+0	+0	A0
V3	G1	S003 Piano D1	-16	+0	+0	+0	+0	D1
V4	G1	S004 Piano Gb1	-16	+0	+0	+0	+0	Gb1

Below the table are several function keys: New... (highlighted), Copies, Delete..., Copy..., Split..., and SoloVce.

■ **Note:** The greyed out button over F2 is a place holder for future expansion.

NEW VOICE

This function creates a new voice.

► To Create a New Voice:

1. Press the **Preset Edit** key. The LED will illuminate and the main preset edit screen will appear.
2. Press the **Voices** soft key (F5) to select the voice edit page of the editor. The Voices soft key will be highlighted.
3. Press the **Utils** function key (F1). Another row of function keys will appear.
4. Press the **New...** function key (F1). A pop up window will inform you that a new voice is being added.

COPY VOICE

This function allows you to copy a voice from any preset to any other preset.

► To Copy a Voice:

1. Press the **Preset Edit** key. The LED will illuminate and the main preset edit screen will appear.
2. Press the **Voices** soft key (F5) to select the voice edit page of the editor. The Voices soft key will be highlighted.
3. Press the **Utils** function key (F1). Another row of function keys will appear.
4. Press the **Copy...** function key (F4). A pop up window will appear. Select the source preset, source voice and the destination preset.



5. Press **OK** to copy the selected voice or **Cancel** to cancel the operation.

DELETE VOICE

This function deletes the selected voice.

► To Delete a Voice:

1. Press the **Preset Edit** key. The LED will illuminate and the main preset edit screen will appear.
2. Press the **Voices** soft key (F5) to select the voice edit page of the editor. The Voices soft key will be highlighted.
3. Press the **Utils** function key (F1). Another row of function keys will appear.
4. Select the voice you wish to delete using the cursor keys or by keying in the voice number when the cursor is over the voice number field.
5. Press the **Delete** function key (F3). A pop up window will inquire if you really want to erase the selected voice.
6. Press **OK** to erase the selected voice or **Cancel** to cancel the operation.

■ **Note:** The Delete Voice function does not erase the samples.

SPLIT VOICE

This function splits the selected voice into two voices. You can split a voice in order to separate and process two ranges of keyboard separately. The edit parameters of the two voices will be identical.

► To Split a Voice:

1. Press the **Preset Edit** key. The LED will illuminate and the main preset edit screen will appear.

2. Press the **Voices** soft key (F5) to select the voice edit page of the editor. The Voices soft key will be highlighted.
3. Select the voice you wish to split using the cursor keys or by keying in the voice number when the cursor is over the voice number field.
4. Press the **Utils** function key (F1). Another row of function keys will appear.
5. Press the **Split** function key (F5). A pop up window will appear with an option to set the split key. The voice will be split just below the split key.

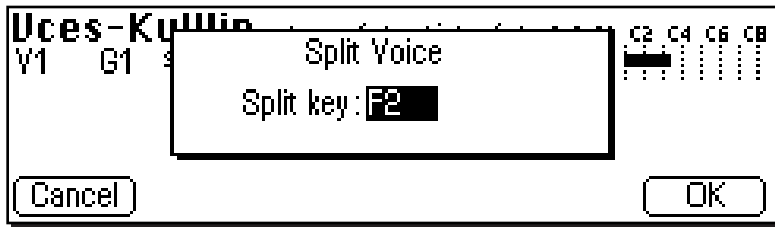

6. Press the **Yes** to split the voice or **No** to cancel the operation.

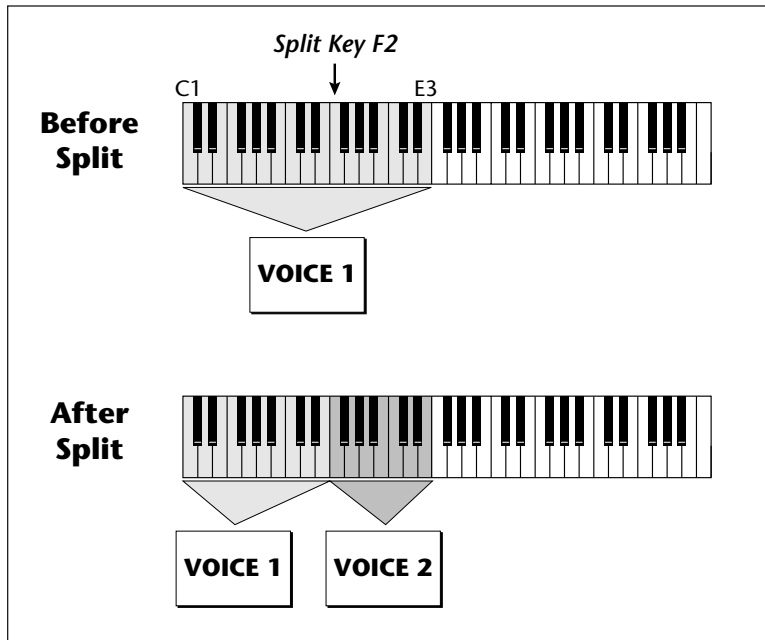

■ **Note:** When a voice is split, both voices contain the complete set of samples that were in the original voice.

SOLO VOICE

When Solo Voice is activated only the currently selected voice will be heard. The voice number will be flashing to remind you that the voice is soloed. Solo voice works both in the Preset Definition level and the Dynamic Processing level of the Preset Editor.

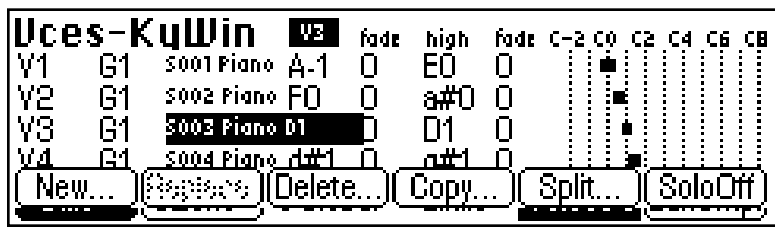

► To Solo a Voice:

1. Press the **Preset Edit** key. The LED will illuminate and the main preset edit screen will appear.
2. Press the **Voices** soft key (F5) to select the voice edit page of the editor. The Voices soft key will be highlighted.
3. Press the **Utils** function key (F1). Another row of function keys will appear.
4. Press the **SoloVce** function key (F6). The row of soft keys will disappear and the Voice indicator on the top line of the display will be flashing.
5. Select the individual voice you want to hear using the cursor keys.
6. Press **Utils** and then **SoloOff** to turn Solo Voice Off.

Sample Zone

Preset
Edit

Voces-KyWin	low	fade	high	fade	C-2	C0	C2	C4	C6	CB
5007 Piano C \sharp 3	a \sharp 2	0	d \sharp 3	0						
5008 Piano G \sharp 3	E3	0	g \sharp 3	0						
5009 Piano C \sharp 4	A3	0	D4	0						
5010 Piano F \sharp 4	A4	0	f \sharp 4	0						

NewSZ... GetMS... Delete... Copy... Combine... Expand...

This submodule contains several utility functions relating to Sample Zones.

■ **Note:** The “greyed out” button over F4 is a place holder for future expansion.

NEW SAMPLE ZONE

This function creates a new sample zone.

► To Create a New Sample Zone:

1. Press the **Preset Edit** key. The LED will illuminate and the main preset edit screen will appear.
2. Press the **Voices** soft key (F5) to select the voice edit page of the editor. The Voices soft key will be highlighted.
3. Select the voice to which the sample zone will be added using the cursor keys or by keying in the voice number when the cursor is over the voice number field. You may also select a sample in the case of a multisample.
4. Press the **SZone** function key (F2). Another row of function keys (shown above) will appear.
5. Press the **NewSZ...** function key (F1). A pop up window will inform you that a new sample zone is being added.

■ **Note:** Certain functions will be “greyed out” if their function is not applicable to the current voice or sample zone selection.

GET MULTISAMPLE

This utility allows you to replace the currently selected samples of a voice with those of any other voice in the bank. **This function does not replace the dynamic processing parameters of the voice. Only the samples are replaced.** This feature allows you to use existing voices as templates. Simply drop in new multisamples to voices you have copied and create a new preset.

► **To Replace a Multisample:**

1. Press the **Preset Edit** key. The LED will illuminate and the main preset edit screen will appear.
2. Press the **Voices** soft key (F5) to select the voice edit page of the editor. The Voices soft key will be highlighted.
3. Select the voice you want to receive the new multisample.
4. Press the **SZone** function key (F2). Another row of function keys will appear.
5. Press the **GetMS** function key (F2). The following pop up window will appear.



6. Select the source preset for the multisample. The samples in this voice will replace those in the currently selected voice.
7. Select the source multisample.
8. Press **OK** to replace the multisample or **Cancel** to cancel the operation.

DELETE SAMPLE ZONE

This function deletes a sample zone from the voice.

► **To Delete a Sample Zone:**

1. Select the sample you wish to delete from one of the voice edit pages. Delete is disabled when you have a voice and not a sample selected.
2. Press the **SZone** function key (F2). Another row of function keys will appear.
3. Press the **Delete** key (F3). A pop up dialog box will ask you if you really want to delete the selected sample.
4. Press **OK** to delete the sample or **Cancel** to cancel the operation.

COMBINE

This function takes all voices in a group and combines them into one multisampled voice. The dynamic processing information of the first voice is used for the new voice. Any dynamic processing information associated with the other voices is lost.

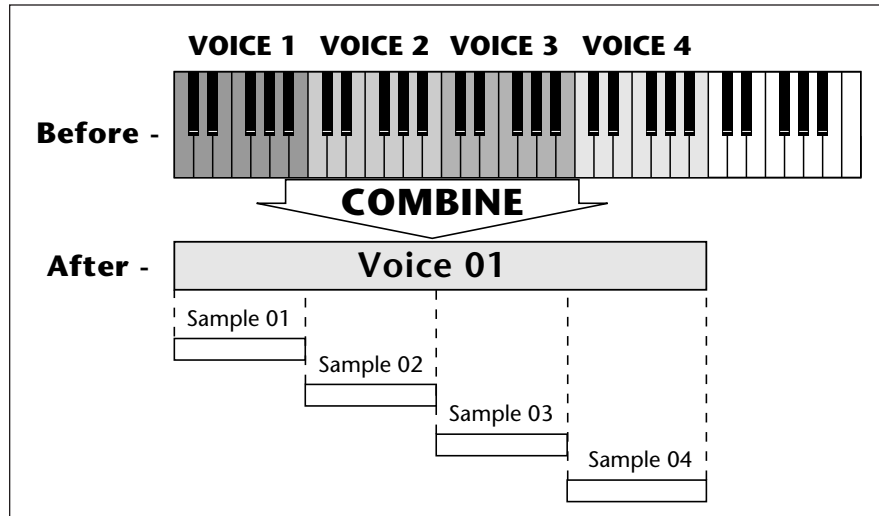

► To Combine Voices:

1. Press the **Preset Edit** key. The LED will illuminate and the main preset edit screen will appear.
2. Press the **Voices** soft key (F5) to select the voice edit page of the editor. The Voices soft key will be highlighted.
3. Press the **SZone** function key (F2). Another row of function keys will appear.
4. Press the **Combine** function key (F5). A pop up window will appear allowing you to select a group of voices to be combined.
5. Select the group containing the voices you want combined. Press **OK** to continue or **Cancel** to cancel the operation.
6. Another pop up window will appear warning you that by combining the voices you are discarding the voice data from all but the first voice. Press **OK** to combine the voices or **Cancel** to cancel the operation.

EXPAND...

This function takes apart the multisampled voices in a bank and makes an individual voice for each sample. The dynamic processing information of the “parent” voice is duplicated for each newly created voice.

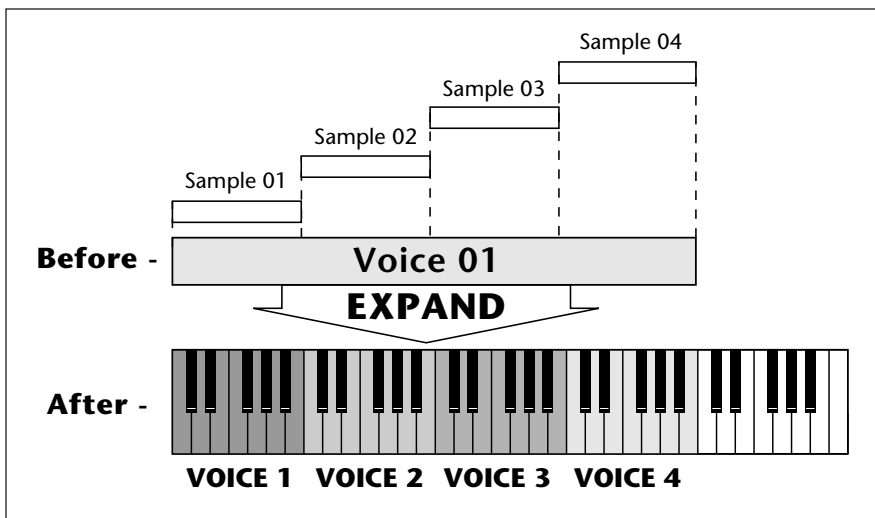

► To Expand Multisampled Voices:

1. Press the **Preset Edit** key. The LED will illuminate and the main preset edit screen will appear.
2. Press the **Voices** soft key (F5) to select the voice edit page of the editor. The Voices soft key will be highlighted.
3. Press the **SZone** function key (F2). Another row of function keys will appear.
4. Press the **Expand..** function key (F6). A pop up window will appear allowing you to select a group of voices to be expanded.
5. Select the group containing the voices you want expanded. Press **OK** to expand the voices or **Cancel** to cancel the operation.

Voices - Key Window

		Key Position				Graphic Display					
		Low/High Key, Crossfades				[Keyboard Diagram]					
		low	fade	high	fade	C-2	C0	C2	C4	C6	C8
V2	G1	multisample	0	C7	0						
	S077	DrawBar Or	C-2	0	C6	0					
	S078	DrawBar Or	c#6	0	g#6	0					
	S094	Octave Wav	A6	0	G8	0					

Utils SZone [Global Links **Voices**] EditVce

Displays Global Editor Pages
Displays Link Editor Pages
Button is highlighted while this page set is displayed.

The Key Window of the Voices screen is accessed by pressing the Next Page key on the front panel from the main Voices screen. The screen shown above will appear.

KEY WINDOW CONTROLS

- **Voice Field:** Link can be selected using the numeric keypad or data entry control.
- **Group Field:** The group number of the voice can be changed using the numeric keypad or data entry control.
- **Sample Name & Number:** The voice's sample(s) can be changed using the data entry control or inc/dec keys.
- **Key Position Controls:** These controls set the high and low key range and the crossfade range in keys for each voice and sample.
- **Graphic Display:** Shows the keyboard positions of each voice and sample.
- **Utilities:** New, Copy, Delete, and Split.
- **Sample Zone:** New Sample Zone, Get Multisample, Delete Sample Zone, Combine and Expand.
- **Edit:** Voice Selection & Dynamic Processing parameters.

KEYBOARD RANGES

When a sample is recorded, it is automatically placed in a voice and assigned a keyboard range specified in the “Auto-Placement” parameters in the Sample Management module. The Key Range Window allows you to edit these assignments and place the voices and samples wherever you want.

❑ **Note:** Remember to SAVE the bank to disk or all your programming will be lost.

Key Position
Low/High Key, Crossfades

Graphic Display

				low	fade	high	fade	C-2	C0	C2	C4	C6	C8
Uces-KyWin													
V1	G1	S256	Syn V	A-1	0	A3	12	[Bar chart showing range from C-2 to C4]					
V2	G2	S257	Syn V	a#3	12	B5	0	[Bar chart showing range from C2 to C4]					
V3	G3	S249	Mahs	C6	0	C7	0	[Bar chart showing range from C6 to C8]					

Utils*
SZone*
[Global
Links
Voices]
Edit/Vce

Displays Global Editor Pages

Button is highlighted while this page set is displayed.

Displays Link Editor Pages

A voice containing only one sample takes the name of the sample. If a voice contains more than one sample, it is called a “♦multisample♦” and the samples it contains are listed below it.

The bars at the right side of the screen give a graphic display of how the voices and samples are assigned to the keyboard. **Voices** are shown as solid black bars, while **Samples** are displayed as hollow bars. Voice keyboard range assignments supersede the assignments of the samples they contain.

The key position is edited by placing the cursor over the desired parameter and then playing the MIDI keyboard or adjusting the data entry control. Voices and samples can be crossfaded according to key position by adjusting the low and high fade parameters. The fade is adjusted in “number of keys” and is graphically represented by a gradual decrease in the height of the bars.

⚡ **Tip:** To create a really high quality voice, you might want to sample every third note or even every note.

More samples are usually better, but the playing technique used while sampling becomes critical the more samples are used!

► **To Switch Voices According to Position**

Assigning voices (samples or multisamples) adjacent to each other is the simplest and most common application of the Key Window. This is also the way samples are “Auto-Placed” in the Sample Manage module. The voices in the screen below are each assigned a one octave range.

Uces-KyWin			low	fade	high	fade	C-2	C0	C2	C4	C6	CB
V1	G4	S249 Aahs	C2	0	B2	0				█		
V2	G4	S242 Aahs	C3	0	B3	0				█		
V3	G1	S242 Aahs	C4	0	B4	0				█		
V4	G1	S243 Aahs	C5	0	B5	0					█	

Another way of visualizing this assignment is shown below.

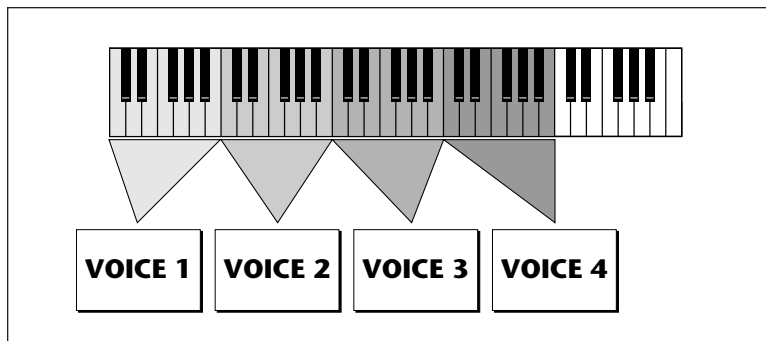

Tip: Samples can be arranged in a voice in exactly the same way that voices are arranged on the keyboard. They can be arranged side by side on the keyboard to minimize the negative effects of pitch shifting or stacked on top of each other to create huge layered sounds, all within a single voice.

► **To Layer Voices and Samples**

The ranges of two or more voices may overlap, and all voices assigned to a key will sound.

1. Press the **Preset Edit** key. The LED will illuminate and the main preset edit screen will appear.
2. Press the **Voices** soft key (F5) to select the voice edit pages of the editor. The Voices soft key will be highlighted.
3. Press the **Next Page** key. The Voices - Key Window will appear.
4. Edit the high and low keys of the voice ranges so they overlap as shown in the screen below. Both voices will now sound when their key range is played.

Vces-KyWin		low	fade	high	fade	C-2	C0	C2	C4	C6	CB
V1	G4	S249	Aahs	C2	0	B2	0				
V2	G4	S242	Aahs	C2	0	B2	0				
V3	G1	S242	Aahs	C3	0	B3	0				
V4	G1	S243	Aahs	C3	0	B3	0				

Utils SZone [Global Links **Voices 1** EditVce

Another way of visualizing this assignment is shown below.

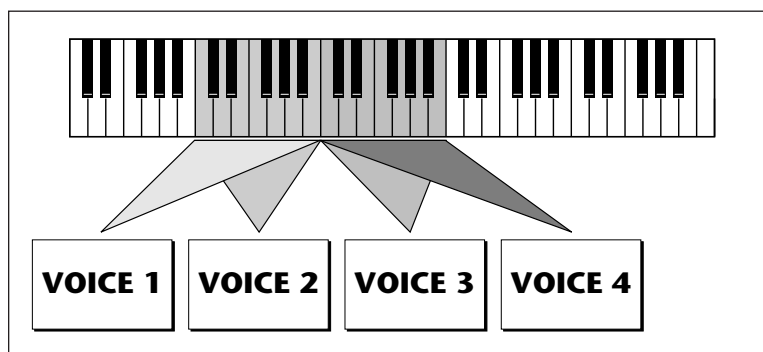

You may wish to assign voices in different layers to different groups. This will allow you to select all the voices in each layer just by selecting the group number. You can edit the group number of a voice in any of the Voice screens.

► **To Positionally Crossfade**

This technique can help mask the point at which two sounds meet. The fade parameters allow the volume of the voice or sample to be faded out as a function of key position. In the screen shown below, voices 1 and 2 are being positionally crossfaded over a range of five notes.

Vces-KeyWin			low	fade	high	fade	C-2	C0	C2	C4	C6	CB
V1	G4	S249 Aqhs	C2	0	d#3	5						
V2	G4	S242 Aqhs	g#2	5	B3	0						
V3	G1	S242 Aqhs	C4	0	B4	0						
V4	G1	S243 Aqhs	C5	0	B5	0						

Utils SZone [Global Links **Voices**] EditVce

As the voice boundaries are crossed playing up the keyboard, the lower voice gradually fades out as the upper voice fades in.

1. Press the **Preset Edit** key. The LED will illuminate and the main preset edit screen will appear.
2. Press the **Voices** soft key (F5) to select the voice edit pages of the editor. The Voices soft key will be highlighted.
3. Press the **Next Page** key. The Voices - Key Window will appear.
4. Edit the high and low keys of the voice ranges so they overlap as shown in the screen below, then set the low and high fades for the two voices. In the center of the crossfade range, both voices will at equal volume.

■ **Note:** These same techniques work when assigning samples within multisampled voices.

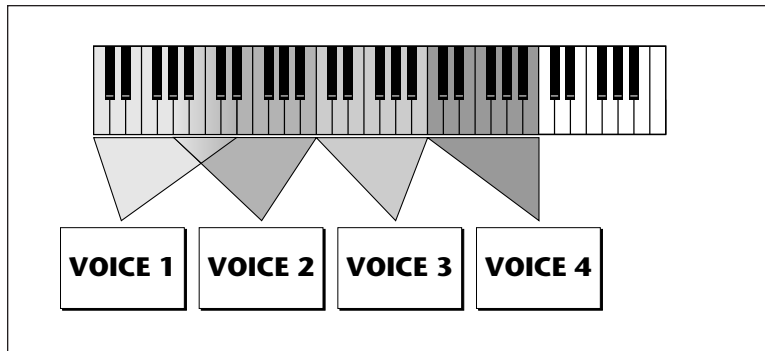

Voices - Velocity Window

Uces-VelWin			low	fade	high	fade	0	32	64	96
V1	G1	S249 Aahs	0	0	63	0	[Bar chart showing velocity range from 0 to 63]			
V2	G2	S242 Aahs	64	0	127	0	[Bar chart showing velocity range from 64 to 127]			

[Utils▲] [SZone▲] [Global] Links [Voices] [EditVce]

The Velocity Window of the Voices screen is accessed by pressing the **Next Page** key on the front panel from the Voices - Key Window screen. A screen similar to the one shown above will appear. In the screen above, the two voices will be “velocity-switched” at a key velocity of 64. At key velocities below 64, voice 1 will play; at key velocities of 64 and above, voice 2 will play.

VELOCITY WINDOW CONTROLS

- **Voice Field:** The voice can be selected using the numeric keypad or data entry control.
- **Group Field:** The group number of the voice can be changed using the numeric keypad or data entry control.
- **Sample Name & Number:** The voice's sample(s) can be changed from this window using the data entry control or inc/dec keys.
- **Velocity Controls:** These controls set the high and low velocity range and the crossfade range for each voice and sample.
- **Graphic Display:** Shows the velocity ranges of each voice and sample.
- **Utilities:** New, Copy, Delete, and Split.
- **Sample Zone:** New Sample Zone, Get Multisample, Delete Sample Zone, Combine and Expand.
- **Edit:** Voice Selection & Dynamic Processing parameters.

Velocity Range

The Velocity Range screen allows you to control the volume of a voice by the key velocity. Using this function, you can crossfade or cross-switch between voices by key velocity. Suppose you had several samples (voices) of the same piano note, one played soft, the next played medium hard, and the third played hard. Using this function, you could set the velocity at which each of the voices would sound, thus recreating the response of the actual instrument.

► To Velocity Switch Voices:

1. Press the **Preset Edit** key. The LED will illuminate and the main preset edit screen will appear.
2. Press the **Voices** soft key (F5) to select the voice edit page of the editor. The Voices soft key will be highlighted.
3. Press the **Next Page** key. The Voices - Key Window will appear.
4. Edit the high and low **Key Range** of the voices so they overlap as shown in the screen below. In order to velocity switch voices, they must first be assigned to the same keyboard range.

❑ **Note:** Remember to *SAVE* the bank to disk or export the preset or all your programming will be lost.

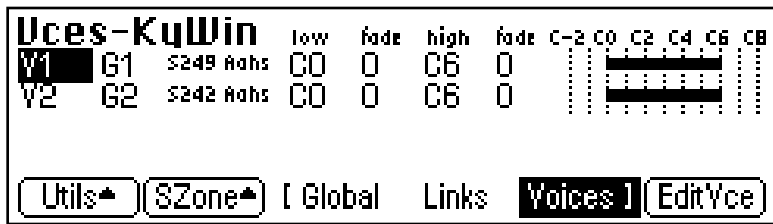

5. Press the **Next Page** key. The Voices - Velocity Window will appear. The default velocity range is from 0-127 or full range. Both voices will sound regardless of what velocity is played.

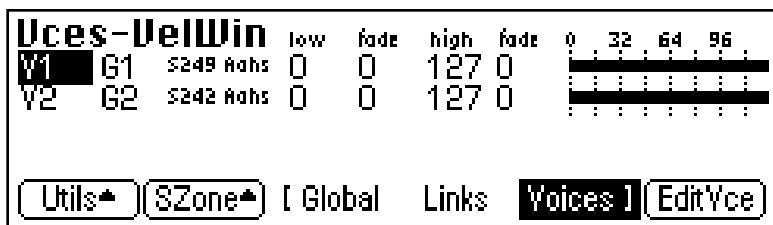

- Set the velocity range of each voice so that voice one sounds in the velocity range of 0-63, while voice two sounds in the velocity range of 64-127.

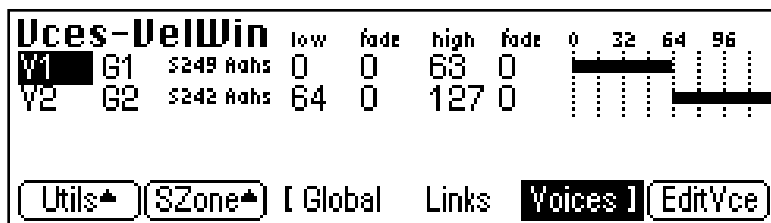

► To Velocity Crossfade Voices:

- Press the **Preset Edit** key. The LED will illuminate and the main preset edit screen will appear.
- Press the **Voices** soft key (F5) to select the voice edit page of the editor. The Voices soft key will be highlighted.
- Press the **Next Page** key. The Voices - Key Window will appear.
- Edit the high and low **Key Range** of the voices so they completely overlap each other. In order to velocity crossfade voices, they must first be assigned to the same keyboard range.
- Press the **Next Page** key. The Voices - Velocity Window will appear.
- The default velocity range is from 0-127 or full range. Set the velocity fades so that voice one fades out the higher the key velocity, while voice 2 fades in, the higher the key velocity. At a velocity of 64, the two sounds will be equal volume. Adjust the fade-in and fade-out points to achieve a natural sounding crossfade. The actual crossfades points will vary depending on the sounds.

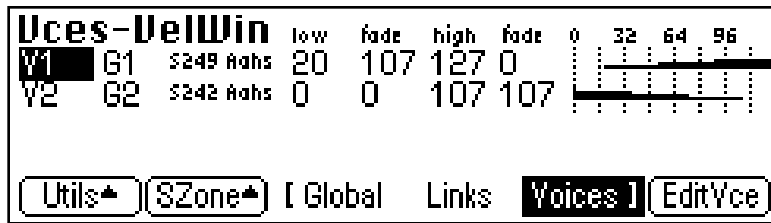

Voices - Realtime Window

Preset
Edit

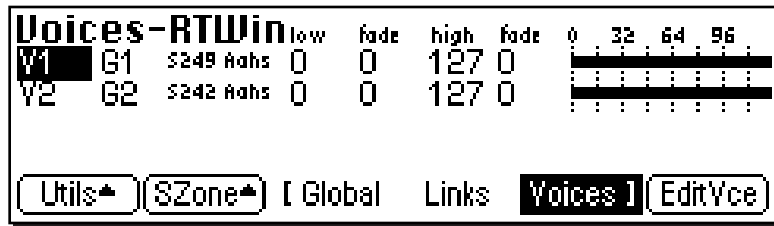

The Realtime Window allows you to control the volume of any number of voices using a realtime controller such as a modulation wheel, a pedal or an LFO or Envelope Generator. It works in a manner very similar to the velocity window except that a realtime controller is used to control the crossfade instead of velocity.

The Realtime Window of the Voices screen is accessed by pressing the **Next Page** key on the front panel three times from the Main Voices screen.

REALTIME WINDOW CONTROLS

- **Voice Field:** The voice can be selected using the numeric keypad or data entry control.
- **Group Field:** The group number of the voice can be changed using the numeric keypad or data entry control.
- **Sample Name & Number:** The voice's sample(s) can be changed from this window using the data entry control or inc/dec keys.
- **Realtime Crossfade Controls:** These controls set the high and low controller value range and the crossfade range for each voice and sample.
- **Graphic Display:** Shows the realtime control ranges of each voice and sample.
- **Utilities:** New, Copy, Delete, and Split.
- **Sample Zone:** New Sample Zone, Get Multisample, Combine and Expand.
- **Edit:** Voice Selection & Dynamic Processing parameters.

Caution:
Realtime Crossfading is one of the more "advanced" applications of the machine. Make sure you understand how to select voices and assign cords before attempting to perform realtime crossfades.

► **To Realtime Crossfade Voices:**

1. Press the **Preset Edit** key. The LED will illuminate and the main preset edit screen will appear.
2. Press the **Voices** soft key (F5) to select the voice edit page of the editor. The Voices soft key will be highlighted.
3. Press the **Next Page** key. The Voices - Key Window will appear.
4. Edit the high and low **Key Range** of the voices so they completely overlap each other. In order to velocity crossfade voices, they must first be assigned to the same keyboard range.
5. Press the **Next Page** key twice. The Voices - Realtime Window will appear.
6. Set the realtime range of each voice. The next screen shows the realtime ranges set so that voice one will begin fading in after the realtime controller reaches a value of 32. Voice two will begin fading out when the realtime control reaches 32 and fades completely out by a value of 80.

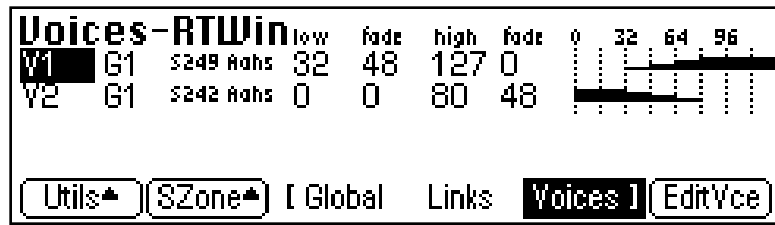

7. So far so good, but this is a Realtime Range. We have to assign a realtime *Controller* to control the crossfade. Press **EditVce** to enter the Dynamic Processing level.
8. Press the **Utils** function key (F1) and then the **VSelect** function key (F2) to bring up the voice selection screen. Select all voices you wish to realtime crossfade. Press **OK**.
9. Press the **Cords** function key (F5). The patchcord assign screen will appear.
10. Assign one of the realtime control sources such as the mod wheel or an LFO to **AmpXfd**. Turn up the Amount parameter to 100%. You should be able to hear the crossfade. Adjust the crossfade ranges and the AmpXfd amount until the crossfade responds correctly.

► **To Randomly Cross-Switch Between Voices:**

In certain situations, such as setting up drum kits, you may want to randomly switch between several voices. **Crossfade Random** is a modulation source specifically designed to handle this situation. Unlike the other random sources, Crossfade Random generates one random number for all voices that are assigned to the same key.

1. Press the **Preset Edit** key. The LED will illuminate and the main preset edit screen will appear.
2. Press the **Voices** soft key (F5) to select the voice edit page of the editor. The Voices soft key will be highlighted.
3. Press the **Next Page** key. The Voices - Key Window will appear.
4. Edit the high and low **Key Range** of the voices so they completely overlap each other. In order to randomly crossfade voices, they must first be assigned to the same keyboard range.
5. Press the **Next Page** key twice. The Voices - Realtime Window will appear.
6. Set the realtime range of each voice. The next screen shows the realtime ranges set so that voice 1 will sound whenever the random value is from 0 to 64. Voice 2 will sound whenever the random value is greater than 64.

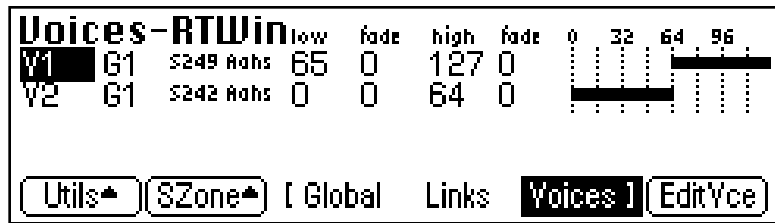

7. Now you have to assign a realtime *Controller* to control the cross-switch. Press **EditVce** to enter the Dynamic Processing level.
8. Press the **Utils** function key (F1) and then the **VSelect** function key (F1) to bring up the voice selection screen. Select all voices you wish to realtime crossfade. Press **OK**.
9. Press the **Cords** function key (F5). The patchcord assign screen will appear.
10. Assign **XfdRnd** to **AmpXfd**. Turn up the Amount to 100%.

PRESET EDIT

Dynamic Processing Level

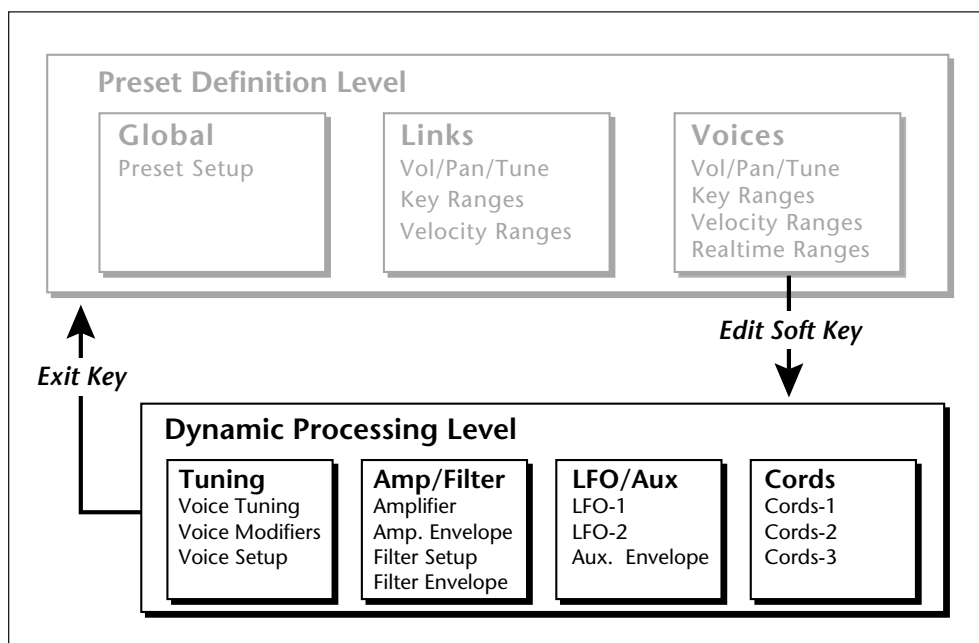

The **Dynamic Processing** level contains the traditional synthesizer controls such as envelope shaping of amplitude and filters as well as modulation parameters. Multiple voices can be selected in this level, unlike in Preset Definition where only one voice can be selected or edited at a time.

The dynamic processing parameters are accessed by pressing the **Edit** soft key while in one of the Voice screens (or directly via an assignable key). Multiple voice selection is supported in any of the dynamic processing editing screens using a MIDI keyboard.

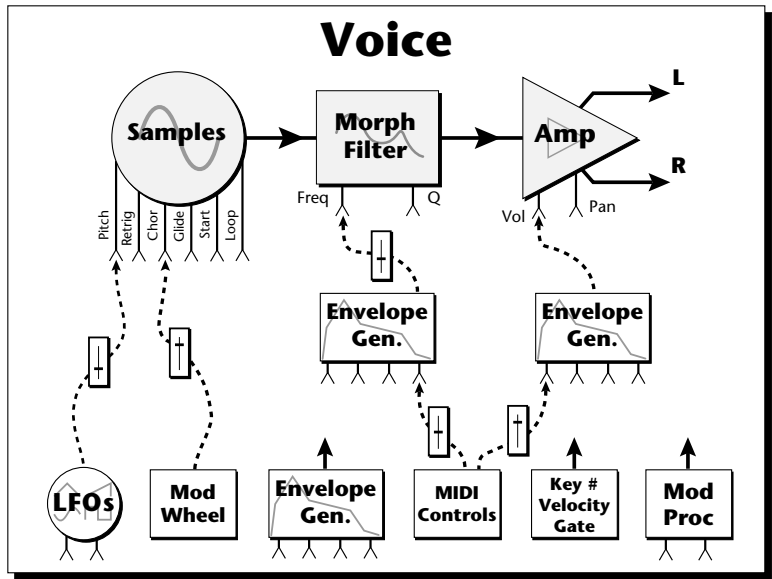

The signal path of the E4K is actually very simple. You have one or more samples, a dynamically controlled filter, and a dynamically controlled amplifier with a panning network. Modulation parameters operate simultaneously on all samples contained in a voice.

Each voice can have its own complete set of synthesizer parameters and modulation routings, or you can select a range of keyboard and edit any parameters you wish for that range. The E4K voice system is very flexible because you can work with multisampled voices or single sample voices.

■ **Note:** When several samples are simultaneously sounding, each one goes through its own filter and amplifier, even though the voice modulation parameters are the same.

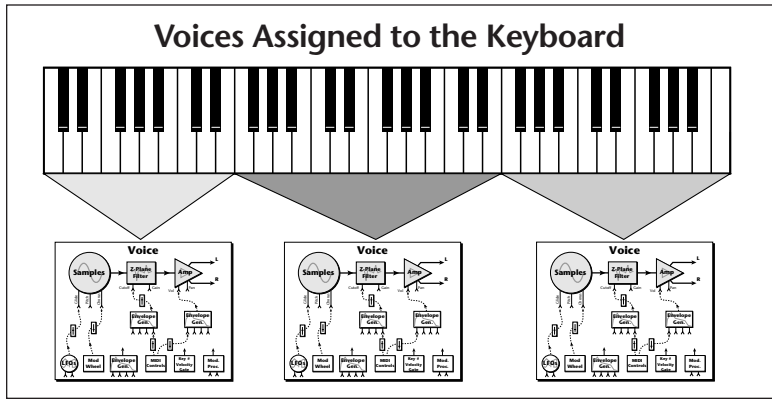

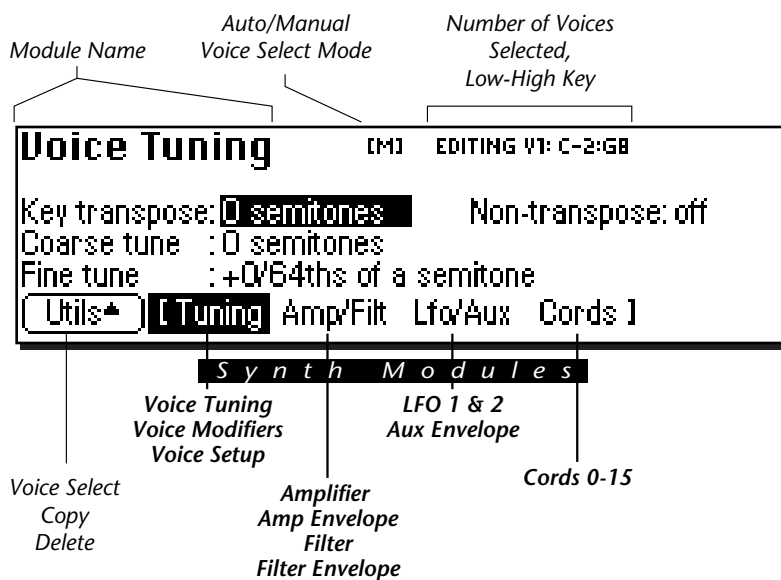

The screen shown above is part of the Dynamic Processing level of the Preset Editor. The page name is shown in the upper left hand corner. The small [M] indicates that voice selection is in Manual Mode. A small diamond ♦ appears next to the Auto/Manual indicator if the range you selected on the keyboard does not correspond with the actual boundaries of the selected voices.

The number of selected voices and the low and high key of the voice range is indicated by the top right line of the display. The lower left soft key enables the Utilities menu. There are also four toggling soft keys which select the synthesizer modules.

- **Tuning:** Contains parameters which control the samples such as Transpose, Tuning, Nontranspose, Chorus, Delay, Start Offset, Glide, and Assign mode.
- **Amp/Filter:** Controls the Dynamic Filter and Amplifier including their dedicated six-part envelopes.
- **LFO/Aux:** Controls two low frequency oscillators and an auxiliary six-part envelope.
- **Cords:** Contains the 18 assignable patchcords which connect everything together.

Tip: The last selected screen in each of the four submodules is remembered by the E4K.

Utilities



The **Utilities** function in the Dynamic Processing level of the Preset Edit module contains the voice selection functions as well as utilities that allow you to perform operations on multiple voices at a time.

Pressing the **Utils** function key (F1) from the Dynamic Processing level enables a second row of soft keys.

- **Voice Select:** Invokes a graphic keyboard display with controls which provide you various ways of selecting voices.
- **Copy Voice(s):** Allows you to copy a group of selected voices to another preset.
- **Delete Voice(s):** Allows you to delete a group of selected voices from the preset.
- **Manual/Auto:** Toggles between Automatic and Manual voice selection modes (without having to go into the Voice Selection screen).
- **Set:** This function allows you to isolate a range of the keyboard and create a new voice from just that range.

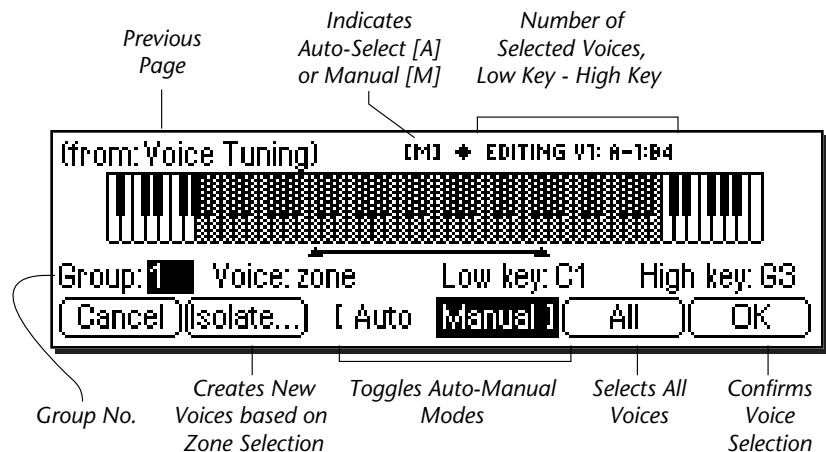

VOICE SELECT

You might want to process one voice, one group, several voices, or the entire keyboard. This important function allows you to select which voice or voices will be processed by the dynamic processing parameters. If there is only one group in the preset, the group selection field will be faded out, indicating that it cannot be selected. Set a specific group number (rather than “all”) to select voices from a specific group.

Soft Keys

- **Cancel:** Cancels the new voice selection.
- **Isolate:** Automatically creates new voices based on new zone selection.
- **Auto/Manual:** Toggles between Auto/Manual voice select modes. *See Automatic Voice Selection.*
- **All:** Selects all voices in the preset.
- **OK:** Confirms the new voice selection.

The Voice field contains several selections

- **All:** Selects all voices in the group.
- **Zone:** This type of selection allows you to select any arbitrary range by selecting low and high keys on the keyboard. The zone range can also be selected by moving the cursor to the low and high key fields and selecting low and high keys with the data entry control. Zone will be automatically selected if you play two different keys on the keyboard.

Pressing the **Isolate** soft key creates a new voice based on the zone selection. Pressing OK after defining a new zone, you will be asked if you wish to “Create new voices based on selection range?”. If you selected a subset of the current voice range, the voice will be split if you answer Yes. If you extend the range of the current voice, the range will be extended by answering Yes. Answering No simply selects the voices without changing them.

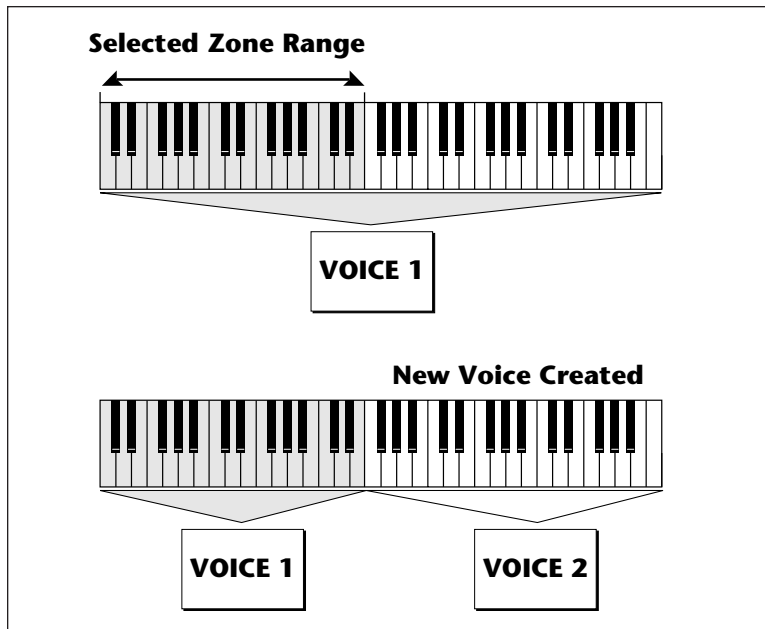

 **Tip:** *This is where having your voices grouped really comes in handy. Simply select the desired group and you're done!*

- **Includes:** If you play a single note the keyboard twice, the voice field will change to “includes”, and the graphic display will indicate the entire range of the voice or voices in which that key is included. The number of voices selected is shown in the upper right corner of the display.
- **Number:** allows you to pick out single voices using the inc/dec keys or the data entry control.

► **To Select a Voice:**

1. Press the **Preset Edit** key. The LED will illuminate and the main preset edit screen will appear.
2. Press the **Voices** soft key (F5) to select the voice edit page of the editor. The Voices soft key will be highlighted.
3. Press the **Edit** function key (F6). The most recently selected Preset Edit screen will appear.
4. Press the **Utils** function key (F1). Another row of function keys will appear.
5. Press the **VSelect** function key (F1). The Voice Select screen will appear.
6. Select the group containing the voices you wish to process. If there is only one group, the group field will be faded out, indicating that it cannot be selected. If the voices you want are not grouped, go on to the next step.
7. Select the voices you wish to process by playing a note on the keyboard or by selecting the voice number for the “Voice” field.
 - Playing a single note on the keyboard changes the voice selector field to “includes” and the voice range you have selected will be darkened on the keyboard display. The upper right corner of the display shows the number of voices you have selected.
 - Playing two different notes on the keyboard changes the voice selector field to “zone”. The voice range you have selected will be shown by the range bar below the display. If you press OK a pop up window will ask you if you want to create a new voice from the selected range. Choosing Yes creates a new voice. Choosing No simply selects the included voices.
8. Press **OK** to confirm the selected voice(s) or **Cancel** to cancel the operation.

► **The Isolate Key:**

Use this key when you want to make a new voice from a section of another voice in order to separately process it.

1. In the voice selection screen, set the Voice parameter to zone.
2. Move the cursor and set the low and high keys of the new voice range using the data entry control, inc/dec keys or the keyboard.
3. Press the **Isolate** soft key (F2). A new voice will instantly be created.
4. Select the new voice and process it.

COPY VOICE(S)

In the Preset Definition level, only one voice could be selected and copied at a time. In this layer, the Dynamic Processing level, multiple voices can be selected. This copy function is different in that it allows multiple voices to be copied and pasted.

► **To Copy Multiple Voices:**

1. Press the **Preset Edit** key. The LED will illuminate and the main preset edit screen will appear.
2. Press the **Voices** soft key (F5) to select the voice edit pages of the editor. The Voices soft key will be highlighted.
3. Press the **Edit** soft key (F6) to select the dynamic processing level of the editor.
4. Press the **Utils** soft key (F1) and then **VSelect** (F1).
5. Select the voices you wish to copy, then press **OK**.
6. Press the **Utils** soft key (F1).
7. Press the **Copy...** soft key (F3).

■ **Note:** For more information about Groups, see Background: Groups, at the beginning of this section.

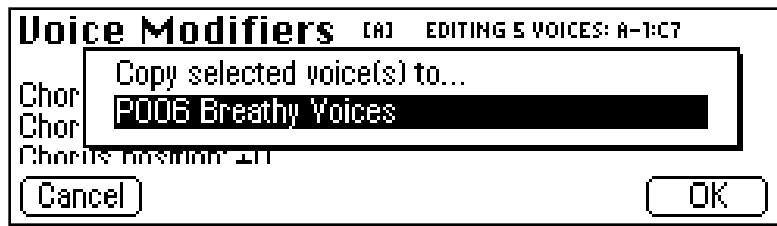

8. Select the destination preset using the data entry control, the inc/dec keys, or the numeric keypad. Press OK when you have selected the destination preset or **Cancel** to cancel the operation. The following screen will appear.



9. Enter the starting key where the copied voices will be placed using the data entry control, the inc/dec keys or your MIDI keyboard. You also have the option to offset the group number of the copied voices. This feature can be used to keep the copied voices separate from voices already in the preset. Press **OK** to copy the voices or **Cancel** to cancel the operation.
10. If you copied the voice(s) to an empty preset, you will be asked to name the new preset.

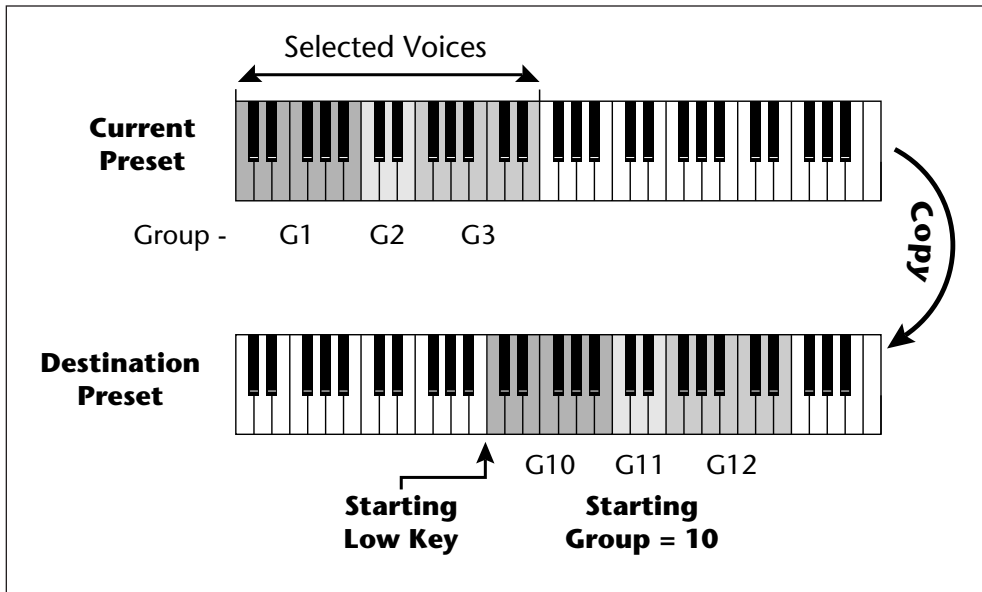

Copied voices can be placed in the destination preset starting at any key number and starting at any group number.

DELETE VOICE(S)

Multiple voices can be deleted at a time using this function. The samples contained within the voices are not deleted.

► To Delete Multiple Voices:

1. Press the **Preset Edit** key. The LED will illuminate and the main preset edit screen will appear.
2. Press the **Voices** soft key (F5) to select the voice edit page of the editor. The Voices soft key will be highlighted.
3. Press the **Edit** soft key (F6) to select the dynamic processing level of the editor.
4. Press the **Utils** soft key (F1) and then **VSelect** (F1).
5. Select the voices you wish to delete, then press **OK**.
6. Press the **Utils** soft key (F1). A pop up window will appear asking you if you really do want to erase the selected voices.
7. Press **OK** to delete the selected voices or **Cancel** to cancel the operation.

AUTOMATIC VOICE SELECTION

Voices within the currently selected group (or All) may also be selected directly from any voice edit screen without having to go back to the voice select screen.

► To Select a Voice using the Auto Select feature:

1. From the Voice Selection screen (Preset Edit, Edit Voice, Utils, VSelect), press **Auto** (F3).
 2. Select a group number (if desired) from the voice selection screen. Auto Select will only select voices from the group you choose (group number or all). Press **OK** to exit voice selection.
 3. Voices will now be selected by playing the keyboard in any voice edit screen (Tuning, Amp/Filt, LFO/Aux, Cords).
- **Selecting a single note will select all voices assigned to that key.**
 - **Selecting a keyboard range by pressing two notes at once will select all voices within that range.**

WARNING

Be careful when selecting a range of voices using Auto Select! When you play the keyboard to hear the results of your edit, you are changing the voice selection range. Be sure to re-key the voice selection range before resuming your editing.

SET

This button performs the same function as the Isolate key in the Voice Selection screen. If the selected key range does not exactly match the voice ranges, you will be asked if you want to isolate new voices from the existing range. Pressing Yes creates a new voice or voices based on your selected range. Pressing No simply selects the included voices.

Voice Tuning, Modifiers & Setup

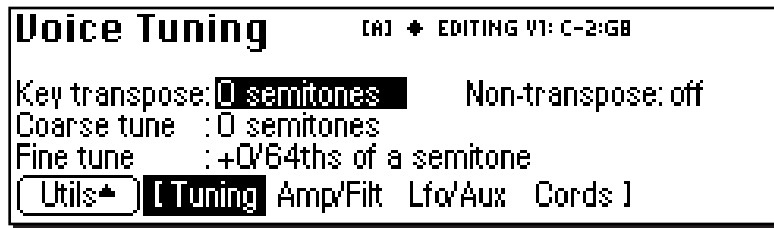

The voice contains several tuning and setup parameters.

- Key Transpose
- Coarse Tuning
- Fine Tuning
- Non-Transpose Mode
- Chorus Parameters
- Delay
- Start Offset
- Glide Parameters
- Solo Modes
- Assignment Group
- Latch Mode

Tip: Transpose, coarse tune, and fine tune can also be edited at the preset definition level in the Voices-Main screen.

KEY TRANSPOSE

This function allows you to transpose the key of the selected voice(s) in semitone intervals by shifting the keyboard position relative to middle C. The transpose range is -24 to +24 semitones. You will normally use the transpose function to tune a voice to its keyboard location, or simply to transpose the voice.

► To Transpose a Voice:

1. From the Dynamic Processing level of the Preset Editor, select the voice(s) you wish to transpose using the voice selection screen, then press the **Tuning** soft key (F2).

2. Use the Previous and Next **Page** keys to locate the Voice Tuning screen shown on the previous page.
3. Select Key transpose, using the cursor keys.
4. Change the transpose parameter to the desired amount using the data entry control or the inc/dec keys.
5. Press the **Exit** key to return to the Preset Definition level of the Preset Editor or press any of the dynamic processing soft keys to move to another module.

COARSE TUNING

This function allows you to change the tuning of the voice in semitone intervals. The coarse tuning range is -72 to +24 semitones. Unlike the transpose function, coarse tuning stretches the pitch of the individual samples assigned to a key and may change the timbre of a voice.

Tip: Use Transpose when you want the voice's timbre to remain constant.

Use Coarse Tuning when you want to change the timbre of the voice.

Tip: Use the Coarse Tuning control to change the tuning of multiple drum voices.

► To Coarse Tune a Voice:

1. From the Dynamic Processing level of the Preset Editor, select the voice(s) you wish to coarse tune using the voice selection screen, then press the **Tuning** soft key (F2).
2. Use the Previous and Next **Page** keys to locate the Voice Tuning screen.
3. Select Coarse tune, using the cursor keys.
4. Change the coarse tuning parameter to the desired amount using the data entry control or the inc/dec keys.
5. Press the **Exit** key to return to the Preset Definition level of the Preset Editor or press any of the dynamic processing soft keys to move to another module.

FINE TUNING

This function allows you to change the tuning of the voice in 1/64 semitone intervals (approx. 1.56 cents). The fine tuning range is ± 1 semitone. Fine tuning can be used to slightly detune a voice, creating a “fatter” sound when it is combined with another voice.

► To Fine Tune a Voice:

1. From the Dynamic Processing level of the Preset Editor, select the voice(s) you wish to fine tune using the voice selection screen, then press the **Tuning** soft key (F2).
2. Use the Previous and Next **Page** keys to locate the Voice Tuning screen.
3. Select Fine tuning, using the cursor keys.
4. Change the fine tuning parameter to the desired amount using the data entry control or the inc/dec keys.
5. Press the **Exit** key to return to the Preset Definition level of the Preset Editor or press any of the dynamic processing soft keys to move to another module.

NON-TRANSCOPE MODE

This function turns keyboard transposition On or Off for the voice. With Nontranspose On, the keyboard will not control the pitch of the voice. This is a useful function for drones or “chiffs”, which you may not want to track the keyboard.

► To Set a Voice to Non-Transpose:

1. From the Dynamic Processing level of the Preset Editor, select the voice(s) you wish to put in non-transpose mode using the voice selection screen, then press the **Tuning** soft key (F2).
2. Use the Previous and Next **Page** keys to locate the Voice Tuning screen.
3. Select nontranspose, using the cursor keys.
4. Turn non-transpose On or Off using the data entry control or the inc/dec keys.
5. Press the **Exit** key to return to the Preset Definition level of the Preset Editor or press any of the dynamic processing soft keys to move to another module.

Tip #1 To avoid L/R pitch drift, use “~” type of modulation in the cords menu.

Tip #2 Set chorus amount to 1% and use chorus width as a pan control which does not span the entire L/R spread.

Tip #3 Set the chorus width to 0% and adjust the ITD to create a through-zero flange effect. With 100% width a panning chorus effect is obtained.

Tip #4 Modulate the ITD to create “Hass Panning” effects.

Tip #5 For a detuned oscillator sound, set stereo width to 100%. Route a free running LFO (~) to chorus position with the amount set to about 25%.

CHORUS AMOUNT

Chorus “thickens” the sound by doubling the sound in stereo and then detuning it.

Amount: is the amount of detuning and is variable from Off to 100%.

Stereo Width: controls the stereo spread. 0% reduces the chorus to mono and 100% gives the most stereo separation.

Inter-Aural Time Delay (ITD): adjusts the delay of the left and right sounds. Positive values start the right channel early and the left late.

Chorus amount and ITD can be modulated in the Cords screen, although ITD can only be changed at the time of the key depression. When Chorus is on, a mono voice will use twice as many channels.

► To Chorus a Voice:

1. From the Dynamic Processing level of the Preset Editor, select the voice(s) you wish to chorus using the voice selection screen, then press the **Tuning** soft key (F2).

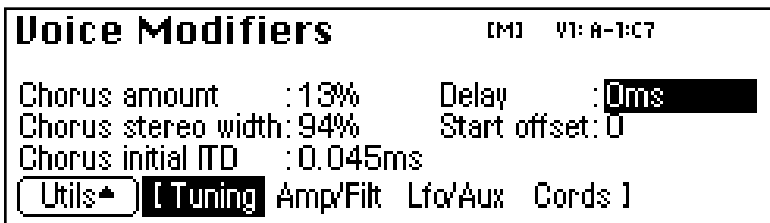

2. Use the Previous and Next Page keys to locate the Voice Modifiers screen shown above.
3. Select Chorus Amount using the cursor keys. Adjust using the data entry control or inc/dec keys.
4. Select the Chorus Stereo Width using the cursor keys. Adjust using the data entry control or inc/dec keys.
5. Select the Inter-Aural Time Delay using the cursor keys. Adjust using the data entry control or inc/dec keys.
6. Press the **Exit** key to return to the Preset Definition level of the Preset Editor or press any of the dynamic processing soft keys to move to another module.

DELAY

Delay varies the time between the arrival of a MIDI Note-On message and the onset of a note. The delay time is adjustable from 0 to 10,000 milliseconds (0-10 seconds). Delay can be used to create echo effects or to thicken the sound when using layered voices.

► To Delay a Voice:

1. From the Dynamic Processing level of the Preset Editor, select the voice(s) you wish to delay using the voice selection screen, then press the **Tuning** soft key (F2).
2. Use the Previous and Next **Page** keys to locate the Voice Modifiers screen.
3. Select delay using the cursor keys.
4. Set the delay time using the data entry control or the inc/dec keys.
5. Press the **Exit** key to return to the Preset Definition level of the Preset Editor or press any of the dynamic processing soft keys to move to another module.

START OFFSET

This function allows you to set where the voice's sample begins playing when you hit a key. A setting of 0 plays a sample from the beginning, higher values move the sample start point toward the end of the sound.

► To Offset the Samples in a Voice:

1. From the Dynamic Processing level of the Preset Editor, select the voice(s) you wish to process using the voice selection screen, then press the **Tuning** soft key (F2).
2. Use the Previous and Next **Page** keys to locate the Voice Modifiers screen.
3. Select start offset using the cursor keys.
4. Adjust the start offset using the data entry control or the inc/dec keys.
5. Press the **Exit** key to return to the Preset Definition level of the Preset Editor or press any of the dynamic processing soft keys to move to another module.

GLIDE RATE

Glide is a smooth gliding between notes instead of the normal instantaneous change in pitch when a new key is pressed. The glide rate determines the time it takes to glide to the new pitch. The larger the value, the slower the glide rate. The rate is adjustable from 0 to 32.738 seconds. Zero seconds equals Off. A glide curve setting of 0 equals linear. Higher values make the curve more exponential. Glide is polyphonic, but can be monophonic when in Solo mode.

► To Change the Glide Rate of a Voice:

1. From the Dynamic Processing level of the Preset Editor, select the voice(s) you wish to glide using the voice selection screen, then press the **Tuning** soft key (F2).
2. Use the Previous and Next **Page** keys to locate the Voice Setup screen shown below.





3. Select glide rate using the cursor keys.
4. Select the rate of glide using the data entry control or the inc/dec keys.
5. Select the glide curve using the cursor keys.
6. Select curve number using the data entry control or the inc/dec keys.
7. Press the **Exit** key to return to the Preset Definition level of the Preset Editor or press any of the dynamic processing soft keys to move to another module.

SOLO MODES

Solo mode provides the playing action of a monophonic instrument. It can make wind and string instruments sound more realistic by preventing more than one note from sounding at once. There are eight different solo modes provided which can be used with monophonic synthesizer sounds or to create other performance effects.

- **Multiple Trigger:** Last note priority. No key-up action. Retrigger envelopes and samples when a key is pressed.
- **Melody (last):** Last note priority. No key-up action.
 - First solo note:* Envelopes start at Attack segment from zero. Samples start at the beginning.
 - If previous note is releasing:* Envelopes start at Attack segment, but from current level. Samples start at the beginning.
 - When playing “Legato”:* Envelopes continue from current segment and level. Samples start at the loop or the beginning if unlooped.
- **Melody (low):** Same as Melody (last), but with low-note priority. Newly played keys which are higher than the lowest solo key held will not sound.
- **Melody (high):** Same as Melody (last), but with high-note priority. Newly played keys which are lower than the highest solo key held will not sound.
- **Synth (last):** Similar to Melody (last), but has key-up action. When the currently sounding solo key is released when other keys are still held, the highest held solo key will sound in a Legato fashion (envelopes not retriggered).
- **Synth (low):** Same as Synth (last), but with low note priority. When the currently sounding solo key is released when other keys are still held, the lowest held solo key will sound in a Legato fashion. (MiniMoog)
- **Synth (high):** Same as Synth (last), but with high-note priority. When the currently sounding solo key is released when other keys are still held, the highest held solo key will sound in a Legato fashion.
- **Fingered Glide:** Same as Synth (last), except that Glide is disabled when playing Staccato, enabled when playing Legato.

 **Tip #1:** Use Melody (high) for chord melody playing where you have a pad layered with a solo sound. Play block chords and have the melody in the outer voice.

 **Tip#2:** A Melody (low) voice overlaid with a Melody (high) voice works well for a “duet”.

► **To Put a Voice into Solo Mode:**

1. From the Dynamic Processing level of the Preset Editor, select the voice(s) you wish to place in solo mode using the voice selection screen, then press **Tuning** (F2).
2. Use the Previous and Next **Page** keys to locate the Voice Setup screen.
3. Select solo mode using the cursor keys.

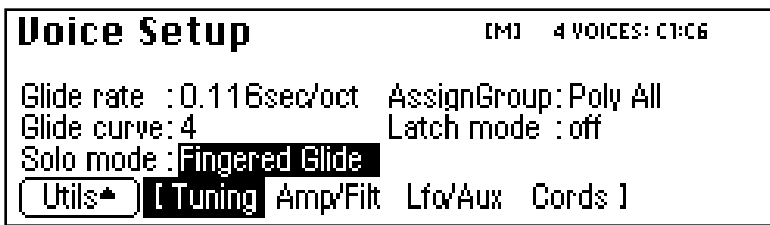

4. Select one of the solo modes using the data entry control or the inc/dec keys.
5. Press the **Exit** key to return to the Preset Definition level of the Preset Editor or press any of the dynamic processing soft keys to move to another module.

LATCH MODE

When Latch mode is On, pressing a key once will latch the key on. Pressing the key again will unlatch the key. This mode was originally designed for doing sound effects work, but you can probably find many other uses for it, such as latching sampled grooves. Any voices assigned to the same key as a latched voice will also latch.

► **To Put a Voice into Latch Mode**

1. From the Dynamic Processing level of the Preset Editor, select the voice(s) you wish to place in solo mode using the voice selection screen, then press the **Tuning** soft key (F2).
2. Use the Previous and Next **Page** keys to locate the Voice Setup screen.
3. Select latch mode using the cursor keys.
4. Press the **Exit** key to return to the Preset Definition level of the Preset Editor or press any of the dynamic processing soft keys to move to another module.

ASSIGN GROUP

This function allows you to assign a certain number of output channels to each voice. By assigning all voices in the preset to assign groups, important parts can be protected from being “stolen” by more recently played keys. Or, a voice such as an open high hat can be assigned to a mono channel so it *will* be cancelled by a closed high hat. Voices will rotate within their assigned bin of channels not interfering with other bins. Poly All is the default mode.

The modes are as follows.

- **Poly All:** Notes are played polyphonically with dynamic channel assignment, using all 128 channels.
- **Poly 16 A-B:** Two bins of 16 channels each. Notes are played polyphonically with dynamic channel assignment, but using no more than 16 channels.
- **Poly 8 A-D:** Four bins of 8 channels each. Notes are played polyphonically with dynamic channel assignment, but using no more than 8 channels.
- **Poly 4 A-D:** Four bins of 4 channels each. Notes are played polyphonically with dynamic channel assignment, but using no more than 4 channels.
- **Poly 2 A-D:** Four bins of 2 channels each. Notes are played polyphonically with dynamic channel assignment, but using no more than 2 channels.
- **Mono A-I:** Nine monophonic channels. Any voices assigned to the same letter interrupt each other, but does not affect other voices.

► To Assign Voices to a Group:

1. From the Dynamic Processing level of the Preset Editor, select the voice(s) you wish to group using the voice selection screen, then press the **Tuning** soft key (F2).
2. Use the Previous and Next **Page** keys to locate the Voice Setup screen.
3. Select assign group using the cursor keys.
4. Select the type of assign group using the data entry control or the inc/dec keys.
5. Press the **Exit** key to return to the Preset Definition level of the Preset Editor or press any of the dynamic processing soft keys to move to another module.

Amplifier/Filter

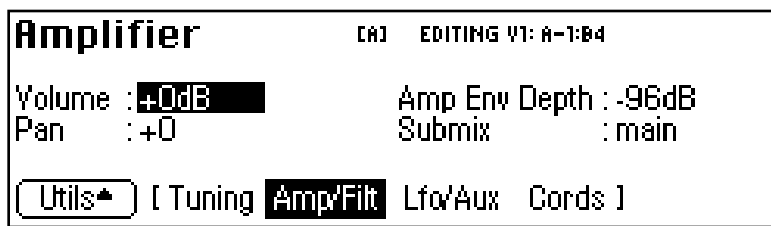

AMPLIFIER PARAMETERS

These parameters set the overall volume and pan settings, as well as the output channels for the selected voice(s).

- **Volume:** Sets the initial volume of the voice. Variable from -96 dB (off) to +10 dB. The default setting is 0 dB which allows a bit of headroom so that other modulators can be added in without clipping. Use this volume control to balance the voice output against others. If you hear clipping, reduce volume setting.
- **Pan:** Sets the initial stereo pan position of the voice. Subsequent modulation is added to or subtracted from this value.
- **Amp Envelope Depth:** Sets the maximum amount of attenuation from the amplifier envelope generator. Variable from -96 dB to -48 dB. With longer attack times, reducing the envelope depth (towards -48 dB) has the perceived effect of providing a more natural volume envelope.
- **Submix:** Allows you to route the selected voice(s) to a pair of output channels.

Note: The submix outputs on the E4K incorporate an automatic “plug-sensing” scheme which ignores submix routings if plugs are not inserted into the appropriate submix output jacks.

► **To Set the Amplifier Parameters:**

1. From the Dynamic Processing level of the Preset Editor, select the voice(s) you wish to process using the voice selection screen, then press the **Amp/Filt** soft key (F3).
2. Use the Previous and Next **Page** keys to locate the Amplifier screen.
3. Adjust the amplifier parameters as desired.
4. Press the **Exit** key to return to the Preset Definition level of the Preset Editor or press any of the dynamic processing soft keys to move to another module.

AMPLIFIER ENVELOPE

The amplifier envelope generator is permanently connected to control the dynamic amplifier although it can also be patched to control any other modulation destination.

- The way the volume of a sound changes over time determines how we perceive that sound. A bell struck with a hammer is instantly at full volume, then slowly dies away. A bowed violin sound fades in more slowly and dies away slowly. Using the amplifier envelope, you can simulate different types of instrument volume envelopes.

Tip: *The envelope rates can be modulated by any controller in the Cords page.*

Attack Rates, Decay Rates, Release Rates or All Rates can be modulated.

► **To Set the Amplifier Envelope:**

1. From the Dynamic Processing level of the Preset Editor, select the voice(s) you wish to process using the voice selection screen, then press the **Amp/Filt** soft key (F3).

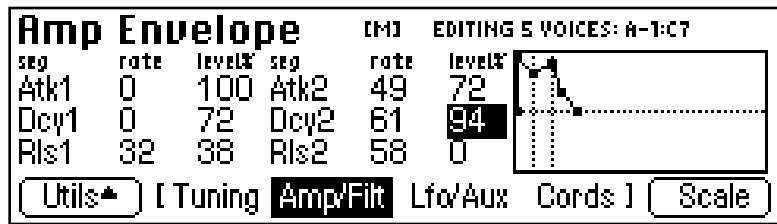

2. Use the Previous and Next **Page** keys to locate the Amp Envelope screen.

Tip: For more information on the Amplifier Envelope see Background: Programming Basics at the beginning of this section.

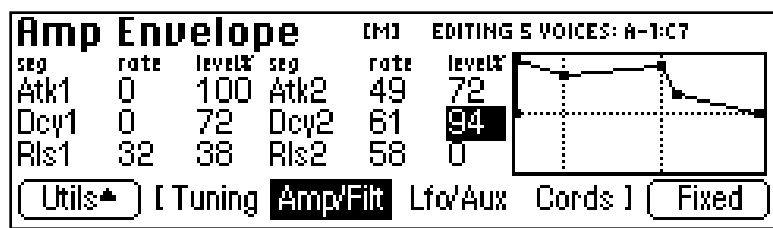

3. Press the **Scale** function key. The graphic display of the filter envelope changes from a “fixed-rate” display to a “time-scaled” display.
4. Select and adjust the amplifier envelope parameters. Use the cursor keys to move the cursor around to the various parameters and the data entry control or inc/dec keys to change the time and level of each stage.
 - Unlike the filter envelope generator, the amplifier envelope does not allow you to set negative levels.
5. Press the **Exit** key to return to the Preset Definition level of the Preset Editor or press any of the dynamic processing soft keys to move to another module.

FILTER PARAMETERS

A low pass filter allows only the low frequencies to pass and can be used to simulate many natural sounds since it is common in the physical world for the high frequencies to die away first as the sound decays. Set the frequency of a lowpass filter at maximum if you do not want any filtering action. The various filter types are described at the beginning of this chapter.

- **Filter Type:** 21 filter types are currently implemented. Standard lowpass, bandpass, and highpass filters are included as well as swept parametrics, phasers, flangers, vocal formant filters and programmable morphing filters.
- **Frequency (Morph):** Sets the initial frequency of the filter. In the case of a Morphing filter, this parameter sets the initial position between the two filters.
- **Resonance (Q, Gain, Resonance, Body Size):** High values of Q amplify frequencies near the cutoff or center frequency.

In a swept EQ, gain controls the amount of boost or cut. In a phaser or flanger, the resonance determines the depth of the effect. In the vocal filters, body size determines the apparent size of the mouth cavity. Gain is a “Note-on parameter, meaning that it is set at note-on time and cannot be continuously varied during the note.

► FILTER TYPES

2-Pole Lowpass

Lowpass filter with 12dB/octave rolloff and Q control.

4-Pole Lowpass

Lowpass filter with 24dB/octave rolloff and Q control.

6-Pole Lowpass

Lowpass filter with 36 dB/octave rolloff and Q control.

2nd Order Highpass

Highpass filter with 12 dB/octave rolloff and Q control.

4th Order Highpass

Highpass filter with 24 dB/octave rolloff and Q control.

2nd Order Bandpass

Bandpass filter with 6 dB/octave rolloff on either side of the passband and Q control.

4th Order Bandpass

Bandpass filter with 12 dB/octave rolloff on either side of the passband and Q control.

Contrary Bandpass

A novel bandpass filter where the poles and zeros cross midway in the frequency range.

Swept EQ, 1-octave

Parametric filter with 24 dB of boost or cut and a one octave bandwidth.

Swept EQ, 2->1-octave

Parametric filter with 24 dB of boost or cut. The bandwidth of the filter is two octaves wide at the low end of the audio spectrum, gradually changing to one octave wide at the upper end of the spectrum.

Tip: The second filter parameter (resonance, Q, gain, body size, peak, expression) is controlled by the 'FilRes parameter in the Cords screen.

Tip: The morphing filters allow high resonance values without losing bass power.

Swept EQ, 3->1-octave

Parametric filter with 24 dB of boost or cut. The bandwidth of the filter is three octaves wide at the low end of the audio spectrum, gradually changing to one octave wide at the upper end of the spectrum.

Phaser 1

Recreates a comb filter effect typical of phase shifters. Frequency moves position of notches. Resonance varies the depth of the notches.

Phaser 2

Comb filter with slightly different notch spacing than Phaser 1. Frequency moves position of notches. Resonance varies the depth of the notches.

Bat Phaser

Phase shift filter with peaks as well as notches.

Flanger Lite

Contains three notches. Frequency moves frequency and spacing of notches. Resonance increases flanging depth.

Vocal Ah-Ay-Ee

Vowel formant filter which sweeps from "Ah" sound, through "Ay" sound to "Ee" sound at maximum morph. Body size varies the apparent size of mouth cavity.

Vocal Oo-Ah

Vowel formant filter which sweeps from "Oo" sound, through "Oh" sound to "Ah" sound at maximum morph. Body size varies the apparent size of mouth cavity.

Dual EQ Morph

This is a programmable 2-frame Morphing filter with two EQ sections. As the Morph value is increased, the filter interpolates from the low to high settings. The Gain of each section remains constant during the Morph, but can be scaled at note-on time by controlling the Initial Gain parameter. This filter can be used to create your own vocal formant filters.

2EQ + Lowpass Morph

This unusual filter has two EQ sections and a lowpass filter whose Fc is also controlled by the Morph parameter. The Lowpass filter is completely open at a setting of 255. As the Morph value is increased, the filter interpolates

from the low to high settings and the lowpass filter allows more high frequencies to pass. The Q of the lowpass filter has an initial setting and can be also modulated at note-on time.

2EQ Morph + Expression

This filter also has two EQ sections and a lowpass filter with independent control over the lowpass filter frequency (Expression). This allows you to use velocity (for example) to control expressive timbre via the lowpass filter, while the Morph parameter is modulated for another effect. As the Morph value is increased, the filter interpolates from the low to high settings.

Peak/Shelf Morph

This 2-frame morphing filter offers independent control over frequency, shelving and peak for each of the two filter “frames”. The Peak parameter can also be scaled at note-on time by controlling the Initial Peak parameter.

When the Shelf parameter is negative, the filter will have a low shelving response. When the Shelf parameter is positive, the filter will assume a high shelving response. With Shelf at zero, the filter assumes a peak filter response.

- Note that the two frames of this filter are displayed from left to right unlike the frames of the other morphing filters which are displayed low to high.

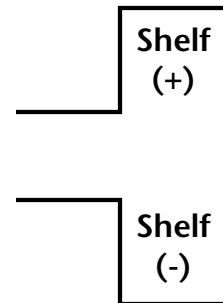

Remember:

*Positive = High Shelf
Negative = Low Shelf*

► To Set the Filter Parameters:

1. From the Dynamic Processing level of the Preset Editor, select the voice(s) you wish to process using the voice selection screen, then press the **Amp/Filt** soft key (F3).
2. Use the Previous and Next **Page** keys to locate the Filter screen.
3. Adjust the filter parameters as desired. The filter envelope, the filter envelope amount (adjusted in the Cords screen), and the initial filter parameters all interact.
4. Press the **Exit** key to return to the Preset Definition level of the Preset Editor or press any of the dynamic processing soft keys to move to another module.

MORPHING FILTER RESPONSE CURVES

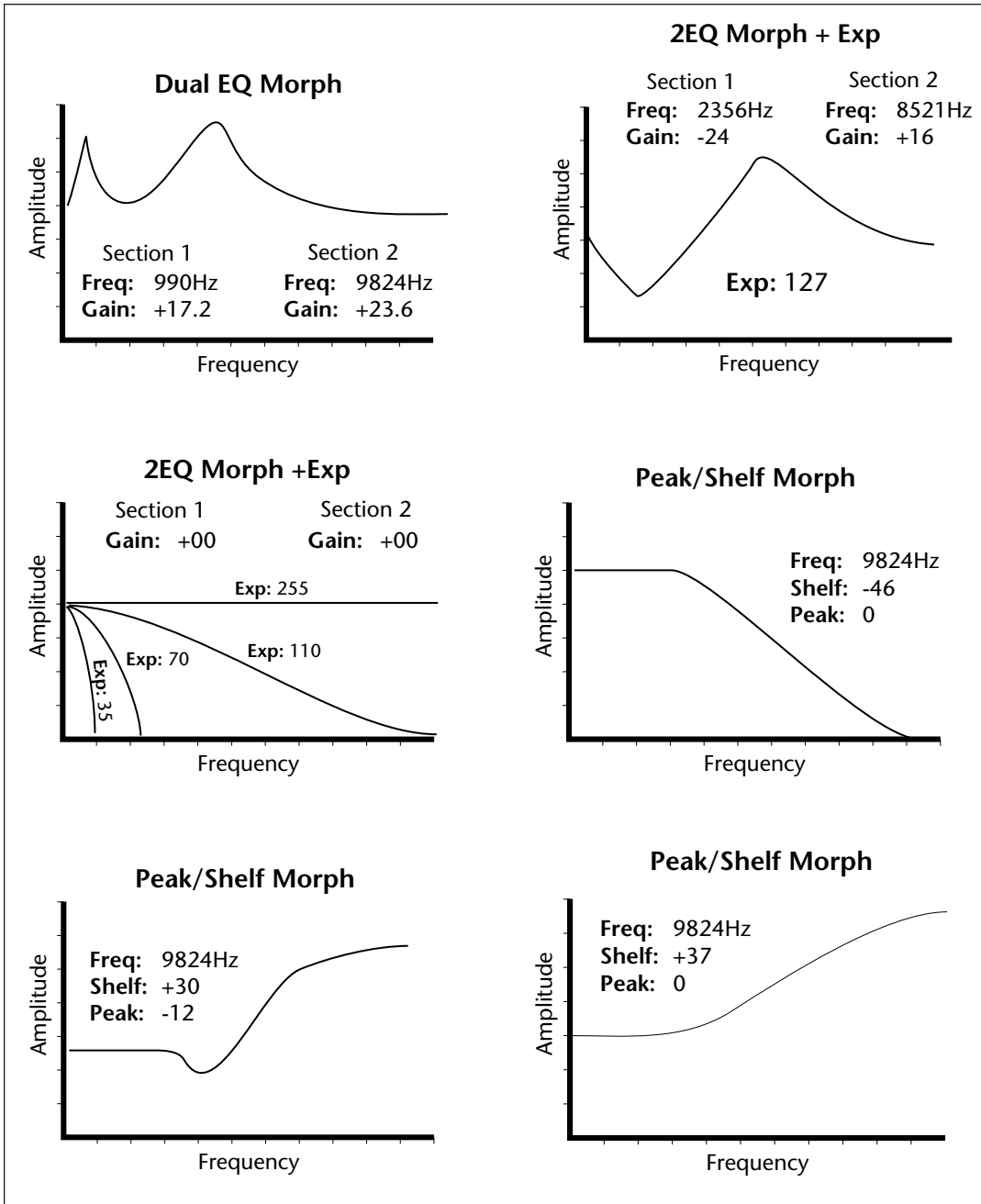

FILTER ENVELOPE

The Filter Envelope is usually assigned to control the filter cutoff parameter although it can be patched to any modulation destination.

► To Set the Filter Envelope:

1. From the Dynamic Processing level of the Preset Editor, select the voice(s) you wish to process using the voice selection screen, then press the **Amp/Filt** soft key (F3).
2. Use the Previous and Next **Page** keys to locate the Filter Envelope screen.
3. Press the **Scale** function key. The graphic display of the filter envelope changes from a “fixed-rate” display to a “time-scaled” display. Use the display view that works best for the envelope you are using.

Tip: For more information on the Filter Envelope see *Background: Programming Basics* at the beginning of this section.

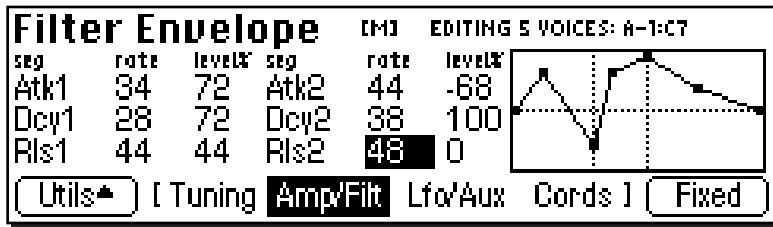

4. Select and adjust the filter envelope parameters. Use the cursor keys to move the cursor around to the various parameters and the data entry control or inc/dec keys to change the time and level of each stage.
- The filter envelope allows you to set negative levels. When patched to the filter cutoff frequency, this useful feature allows the envelope to lower the cutoff frequency below the initial setting.
5. Press the **Exit** key to return to the Preset Definition level of the Preset Editor or press any of the dynamic processing soft keys to move to another module.

LFO/Auxiliary Envelope

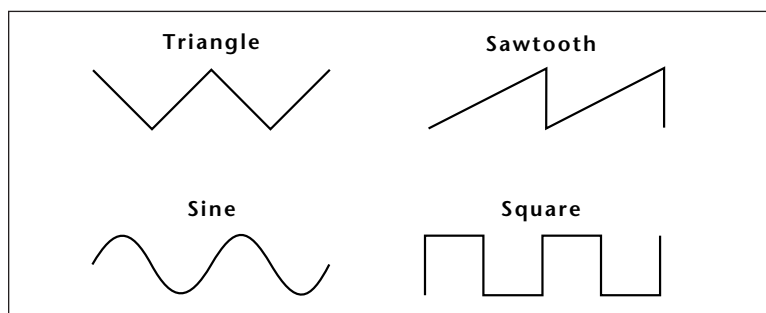

Tip: You must connect the LFO to a destination in the Cords screen in order for it to have any effect.

- **Delay:** Sets the amount of time between playing a key and the onset of modulation. This can be used to simulate an effect often used by acoustic instrument players, where the vibrato is brought in only after the initial note pitch has been established. The delay range is adjustable from 0 seconds to 20 seconds.
- **Variation:** Sets the amount of random variation on an LFO each time a key is pressed. This function is useful for ensemble effects, where each note played has a slightly different modulation rate. The higher the number, the greater the note to note variation in the LFOs.
- **Sync:** Key Sync or Free Running. With key sync selected the LFO wave starts at the beginning of its cycle at each key depression. In free run mode, the LFO wave begins at a random point in its cycle on each key depression.

► To Program an LFO:

1. From the Dynamic Processing level of the Preset Editor, select the voice(s) you wish to process using the voice selection screen, then press the **Lfo/Aux** soft key (F4).
2. Use the Previous and Next **Page** keys to locate the LFO 1 or LFO 2 screen.
3. Adjust the LFO parameters as desired.

4. Press the **Exit** key to return to the Preset Definition level of the Preset Editor or press any of the dynamic processing soft keys to move to another module.

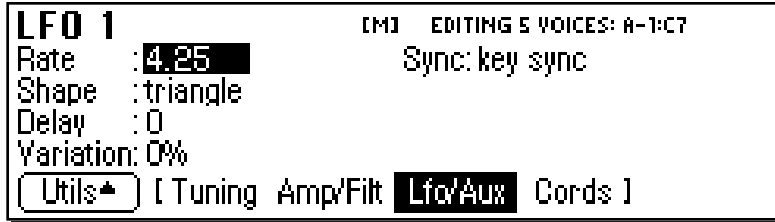

LAG PROCESSORS

The LFO 2 screen contains controls for the two lag processors used in the modulation Cords screens. Lag processors can be inserted in a modulation patch to inhibit rapid changes in the modulation source or cause it to lag behind the input. The amount (rate) of lag is adjustable from 0 to 10. A setting of 0 will cause the least amount of lag. 10 is the slowest lag. The diagram below illustrates one way that a lag processor might be used.

► To Program the Lag Processors:

1. From the Dynamic Processing level of the Preset Editor, select the voice(s) you wish to modify using the voice selection screen, then press the **Lfo/Aux** soft key (F4).
2. Use the Previous and Next **Page** keys to locate the LFO 2 screen.
3. Use the cursor keys to select the lag processors.

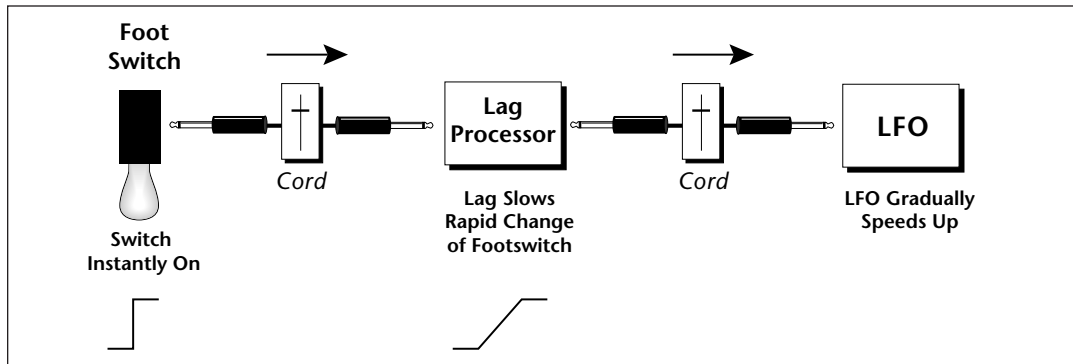

4. Adjust the lag time of processor 1 or 2.
5. Insert the lag processor after a modulation source in the Cords screen.
6. Press the **Exit** key to return to the Preset Definition level of the Preset Editor or press any of the dynamic processing soft keys to move to another module.

AUXILIARY ENVELOPE

The auxiliary envelope is a general purpose envelope generator that can be patched to any modulation destination.

► To Set the Auxiliary Envelope:

1. From the Dynamic Processing level of the Preset Editor, select the voice(s) you wish to modify using the voice selection screen, then press the **Lfo/Aux** soft key (F4).
2. Use the Previous and Next **Page** keys to locate the Aux Envelope screen.
3. Select and adjust the auxiliary envelope parameters. Use the cursor keys to move the cursor around to the various parameters and the data entry control or inc/dec keys to change the time and level of each stage.

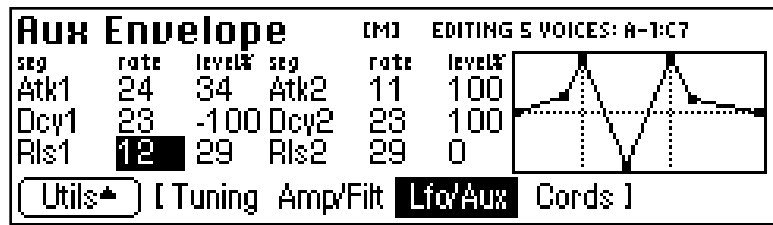

- Like the filter envelope generator, the auxiliary envelope allows you to set negative levels. This can be very useful to create attack “blips” when controlling the pitch of a voice.
4. Press the **Exit** key to return to the Preset Definition level of the Preset Editor or press any of the dynamic processing soft keys to move to another module.

Cords

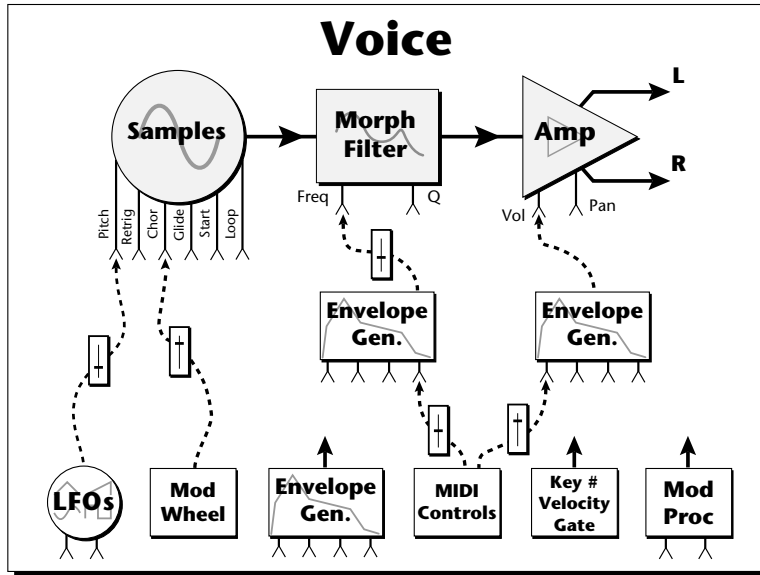

Cords 00 to 05		[M]	EDITING 5 VOICES: A-1:C7			
# source	dest	amount	# source	dest	amount	
00: Yel<	FillFreq	+28%	03: ModWl	CO2Amt	+13%	
01: PitWl	Pitch	+6%	04: Yel<	FillFreq	+36%	
02: Lfo1~	Pitch	+0%	05: FEnv+	FillFreq	+0%	

Utils [Tuning Amp/Filt Lfo/Aux **Cords 1** Zoom

+	0 ... 127
~	-64 ... +63
<	-127 ... 0

Several of the modulation sources use the designators shown at left to indicate their polarity.

- +** modulation ADDs to the current value. (Normal modulation.)
- ~** centers modulation around zero. (Good to control Filter Fc.)
- <** would be useful for controlling volume, as it only subtracts from the initial value. (Max. control = 0)

Modulation Sources

- Off
- Crossfade Random
- Key (+, ~), Velocity (+, ~, <)
- Release Velocity, Gate
- Pitch Wheel, Mod Wheel
- Pressure, Pedal
- MIDI A-H, Foot Switch 1 & 2
- Flip-Flop Foot Switch 1 & 2
- MIDI Volume (Contr. 7)
- MIDI Pan (Contr. 10)
- Key Glide
- Volume Envelope (+, ~, <)
- Filter Envelope (+, ~, <)
- Aux. Envelope (+, ~, <)
- LFO 1 & 2 (+, ~)
- White Noise, Pink Noise
- kRandom 1 & 2,
- Lag 1 in (summing amp out)
- Lag 2 in (summing amp out)
- Lag Processor 0 & 1
- DC Offset, Summing Amp
- Switch, Absolute Value
- Diode, Flip-Flop, Quantizer
- Gain 4x

Modulation Destinations

- Off
- Key Sustain, Fine Pitch, Pitch
- Glide, Chorus Amt
- Chorus Position ITD
- Sample Start, Sample Loop
- Sample Retrigger
- Filter Freq., Filter Resonance
- Amplifier Volume, Amp Pan
- Amplifier Crossfade
- Volume Envelope Rates (all)
- Vol. Env. Atk, Dcy, Release
- Filter Envelope Rates (all)
- Filt. Env. Atk, Dcy, Release
- Aux. Envelope Rates (all)
- Aux. Env. Atk, Dcy, Release
- LFO 1 & 2 Rates
- Lag Processor In 0 & 1
- Summing Amp, Switch
- Absolute Value
- Diode, Flip-Flop, Quantizer
- Gain 4x
- Cord 0-15 Amount

Tip: Realtime events happen first on lower numbered cords, so it is usually a good idea to put important functions on lower numbered cords and to place components of complex modulations patches in the proper order in the Cords screens. This also makes it easier to visualize your patch.

Tip: The Flip-Flop Footswitch will stay On until it is pressed again. Then it will toggle Off.

CORDS

The 18 “patchcords” allow you to route modulation sources to destinations and control the amount of modulation. The cords connect everything together in the voice. There are only two permanently connected cords: amp envelope to amplifier, and key to pitch. Any other connections must be connected with a cord. There are currently 56 modulation sources and 53 destinations for the patchcords. Some of the modulation sources, such as the lag processors and the diode, are control processors. They modify control signals. All these devices can be combined to create almost infinite patching possibilities.

► To Connect a Patch Cord:

1. From the Dynamic Processing level of the Preset Editor, select the voice(s) you wish to process using the voice selection screen, then press the **Lfo/Aux** soft key (F4).
2. Use the Previous and Next **Page** keys to locate one of the three Cords screens.

Cords 00 to 05			[M]	EDITING 5 VOICES: A-1-C7		
source	dest	amount	source	dest	amount	
00: Vel:	AmpVol	+28%	03: ModWl	CO2Amt	+13%	
01: PitWl	Pitch	+6%	04: Vel:	FltFreq	+36%	
02: Lfo1~	Pitch	+0%	05: FEnv+	FltFreq	+0%	

Utils* [Tuning Amp/Filt Lfo/Aux **Cords**] Zoom

3. Connect the modulation sources to destinations and set an amount. The possible sources and destinations are listed at left. Keep in mind that modulation amounts interact with the initial settings.
4. Press the **NEXT** page key to move on to the second page and third pages of modulation cords. There are a total of 16 cords.
5. The **Zoom** soft key immediately jumps you to the screen related to the currently selected patchcord destination.
6. Press the **Exit** key to return to the Preset Definition level of the Preset Editor or press any of the dynamic processing soft keys to move to another module.

SAMPLE RETRIGGER

This modulation destination allows you to retrigger a sample using a modulation source. A **negative going zero-crossing** triggers the sample from the sample start.

LFOs (~) and envelopes are obvious choices for trigger sources. By adjusting the envelope rates, you can time the onset of each sample retrigger. A continuous controller such as a mod wheel will retrigger the sample when it goes to zero. White and pink noise cause random retriggering. By adjusting the Amp Envelope to create an artificial decay, Sample Retrigger can be used to create echo effects.

► To Retrigger the Sample:

1. From the Dynamic Processing level of the Preset Editor, select the voice(s) you wish to process using the voice selection screen, then press the **Cords** soft key (F5).
2. Select a free patchcord and connect any negative going modulation source (such as an LFO ~) to SRetrig.

Tip: Use negative cord amounts with an LFO to create a more realistic echo effect.

Cords 06 to 11			[M] 4 VOICES: C1:C6				
#	source	dest	amount	#	source	dest	amount
06:	Lfo1~	SRetrig	-1%	09:	Off	Off	+0%
07:	Off	Off	+0%	10:	Off	Off	+0%
08:	Off	Off	+0%	11:	Off	Off	+0%

Utils* [Tuning Amp/Filt Lfo/Aux **Cords 1**]

3. Set the Cord Amount to any value other than 0.
4. Press the LFO/Aux function key and use the page keys to locate the LFO 1 screen.
5. Adjust the LFO rate to the desired frequency. When a key is pressed, you should hear the sample retriggering.
6. Press the **Exit** key to return to the Preset Definition level of the Preset Editor or press any of the dynamic processing soft keys to move to another module.

Appendix

SCSI	345
SMDI Transfers	349
Multiple Samplers on SCSI	350
E4K Menu Maps	351
Memory Upgrade	354
Specifications	361
Warranty	362
Index	364

Appendix

SCSI

SCSI (pronounced skuzzy) stands for Small Computer System Interface. SCSI is an industry standard hardware and software specification that allows high-speed data transfers between different pieces of equipment. SCSI devices can include hard disks, tape drives, optical disks and other types of digital equipment.

Why Use SCSI?

- **SCSI is fast!** SCSI is a parallel interface which transmits eight bits of information at a time at high speed over the SCSI cable. MIDI, in comparison, is a serial interface which can only send one bit of information at a time over its line.
- **Compatibility:** Since SCSI is an industry standard, equipment from many different manufacturers can be linked to work together.
- **Expandability:** Up to eight SCSI devices can be linked together (the E4K counts as one SCSI device on the chain).

The SCSI Bus

You may have noticed that the rear panel of most external storage devices have two SCSI connectors. This is because SCSI devices are connected together in a chain arrangement. The wires that connect the different pieces of equipment are called the SCSI bus.

ID Numbers

Each device on the SCSI bus has its own ID number so that it can distinguish its data from data meant for another device. If data is being saved to a device with ID-2 for instance, all the other devices on the SCSI bus will ignore that

data. If two devices have the same ID number, the system **will not work**. Each device must have its own unique ID number.

The SCSI ID number of a Macintosh computer is fixed at ID-7 and cannot be changed. The SCSI ID numbers of most other devices can be changed.

Many SCSI devices have hardware defined ID numbers, which means that they have a switch on the front or the back of the unit which allows the ID number to be easily identified and changed.

The following is a list of the default SCSI ID numbers:

ID - 7 (fixed)	Macintosh
ID - 6	E4K (this number can be changed)
ID - 5	Unassigned
ID - 4	Unassigned
ID - 3	Unassigned
ID - 2	Unassigned
ID - 1	Internal E4K HD
ID - 0	Internal Macintosh HD (if installed)

Types of SCSI Cables

There are two basic types of SCSI cables in use: DB25 and 50-pin Centronics. The two types of cable can be identified by their connectors, which are quite different. When buying SCSI extension cables, it is important to choose ones with the right type of connectors, since the two types will not interconnect without a special adapter. The type of SCSI connectors on the Macintosh are DB25 connectors. These are the type commonly found on the back of personal computers. The SCSI connectors on the E4K SCSI ports are the 50-pin Centronics type. Use only high quality shielded cables that have all the pins connected. Many cables only have some of the pins wired.

Terminating SCSI Cables

The total length of the SCSI chain should not exceed 15 feet. A general rule for SCSI cables is: **The Shorter the Better!**

Terminating resistors or terminators are special resistor packs that are installed on the **first and last device in the SCSI chain**. Terminators are used to reduce line echoes or standing waves on the SCSI bus. An analogy in an audio system would be impedance matching.

Terminators can either be hidden inside a SCSI device or they can take the form of termination blocks which can simply be plugged into the SCSI port.

Terminators apply power to an array of resistors to ensure a full 5 volt swing between high and low levels on the SCSI line. The host system is required to provide Termination Power. Termination power has its own wire in the SCSI cable and supplies power to the termination block. On external hard disk drives, SCSI terminator power is almost always turned Off and the drives are left un-terminated.

The E4K is shipped with termination power On and termination resistors On. This assumes that the E4K will be placed at one end of the SCSI chain. **The E4K has an automatic system which ONLY supplies terminator power when it is NOT being supplied by another device.** Therefore, you do not need to worry about terminator power when connecting the E4K. The termination resistors in the E4K can be turned On or Off under software control. This function is located under **Miscellaneous** in the **Master** menu. If you have an E4K connected in the middle of a SCSI chain (which can be done using a special SCSI "Y" cable), you would want to turn SCSI termination Off. Normally, the E4K will be at one end of the chain and will have termination On.

The more devices you have connected to SCSI and the longer your cables are, the more it becomes important to have the cables properly terminated.

 **Caution:** Turn all devices OFF whenever you change the SCSI cable. Serious damage to the E4K may result from connecting and disconnecting SCSI cables with power applied.

SCSI PROBLEMS

In diagnosing SCSI problems the first rule is: Don't panic, experiment! If you have several SCSI devices hooked up, first check the SCSI ID numbers, then try disconnecting one of the devices and maybe change the order of the units on the line. There are quite a number of different SCSI drives on the market each with slightly different electrical characteristics. The following checklist may help you find the solution to your unique SCSI setup.

1. **Make sure the drive is mounted.** Mount the drives using the Mount Drive utility (Disk, Utilities).
2. **Check the SCSI ID numbers.** No two numbers on the bus can be the same.
3. **Read the documentation again.** Learn all you can about your peripheral devices. The answer to your problem may be right in front of you.
4. **Play with the order in which devices are powered up.** Normally the "Big Bang" method works best (turn everything on at once), but another order may work better in your unique system. Experiment!
5. **Always suspect the cable when something doesn't work on the SCSI bus.** Remember: The shorter the cables are, the better.
6. **Simplify the situation.** Disconnect one or more drives until you get the system to work.
7. **Are the ends of the SCSI bus terminated?**
8. **If all else fails, call us.** We're here if you need us. 408-438-1921 Telephone support hours are 9:00 to 5:00 PST, Monday through Friday.

SAMPLE TRANSFERS VIA SMDI

The E4K can now be connected to the SCSI along with another E4K, an EIV, an e-64, an ESI-32, or a personal computer. Multiple “Master” devices on the SCSI bus is not normally allowed by the standard SCSI protocol but is possible because of E4K's advanced SCSI and SMDI (or SCSI Musical Data Interchange) implementation. Sample data can now be exchanged over the SCSI bus in a way similar to the MIDI Sample Dump Standard, except *MUCH* faster.

The computer should normally be positioned at one end of the chain and the E4K at the other. The SCSI chain is properly terminated at each end by the computer and the E4K. Devices in the middle of the chain should not have termination resistors installed.

- **PC Compatibles** - The E4K has been tested with IBM PC compatible computers using the Adaptec model 1542C SCSI option card. Sound files can be transferred between a PC computer and the E4K using Sound Forge™, Recycle™ or other sample editing software.

- **Macintosh** - Sound files can be transferred between a Macintosh computer and the E4K using Recycle™, Transfer Station™, Alchemy™ or other digital sample editing software. The E4K is able to access approved Macintosh internal CD-ROM drives with CD-ROMs containing E4K compatible files.

- The E4K is strictly a “Slave Device” when using SMDI, meaning that it CANNOT initiate SMDI transfers. This should not normally present a problem, since a computer based editor will always have a facility for initiating SMDI transfers.

✦ **Caution:** A sample transferred into the E4K will be automatically placed across the entire keyboard, overwriting the current preset's sample placement. Create a new empty preset before downloading via SMDI to avoid trashing the current preset.

- Besides the raw sample data, additional information about the sample is included in a SMDI file.

✦ **Tip:** You can check the “Memory Statistics” screen when downloading samples via SMDI to keep track of how much RAM you have left.

✦ **Caution:** When using Alchemy, you must add one to the sample number you want transferred.

✦ **Caution:** You cannot transfer to or from sample 000 (the clipboard).

™ Alchemy, Recycle, Sound Forge and Transfer Station are all trademarks of their respective companies.

- » Sample name and number (samples 1-999)
- » Multichannel/Stereo/Mono status
- » Sample length plus one set of loop begin/end points
- » Sample rate, pitch and bit resolution
- » Sample key placement (an E-mu extension to SMDI)

Using Multiple Samplers on the SCSI Bus

E4K software contain SCSI bus arbitration so that multiple “Master” devices can share the bus without a system crash. Two E4K's (an EIIIIX, an ESI-32, an e-64, or an E-IV) can share the same sound library, without having to duplicate the storage media.

When connecting your system for use with multiple E4K's, be sure to observe the following rules:

- **NEVER try to write to two devices at the same time or write to one device while loading from another.** Designate one unit as the Master which is the **ONLY** unit allowed to write. Turn Undo Off on all units except the Master. Simultaneous reads are OK.
- Keep SCSI cable lengths as short as possible (Under 12 feet total).
- Make sure that each SCSI device has its own unique ID number. (Remember that the E4K and EIIIIX each use up an ID number in addition to their internal hard disks.)
- Make sure the system is correctly terminated - The E4K's should normally be on the ends of the SCSI chain.

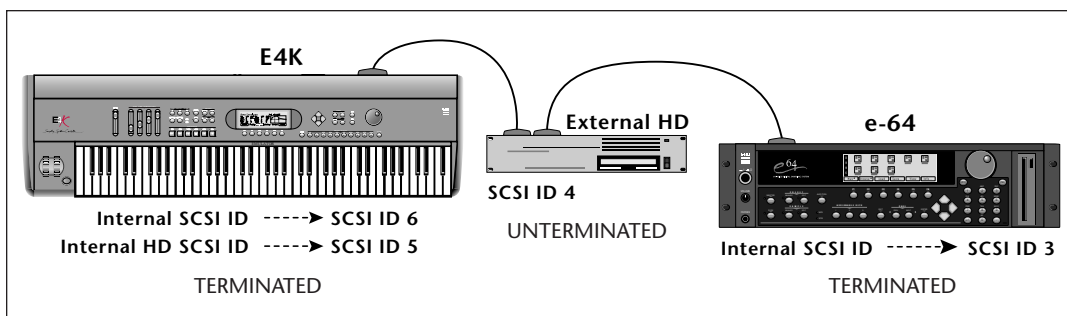

E4K Menu Maps

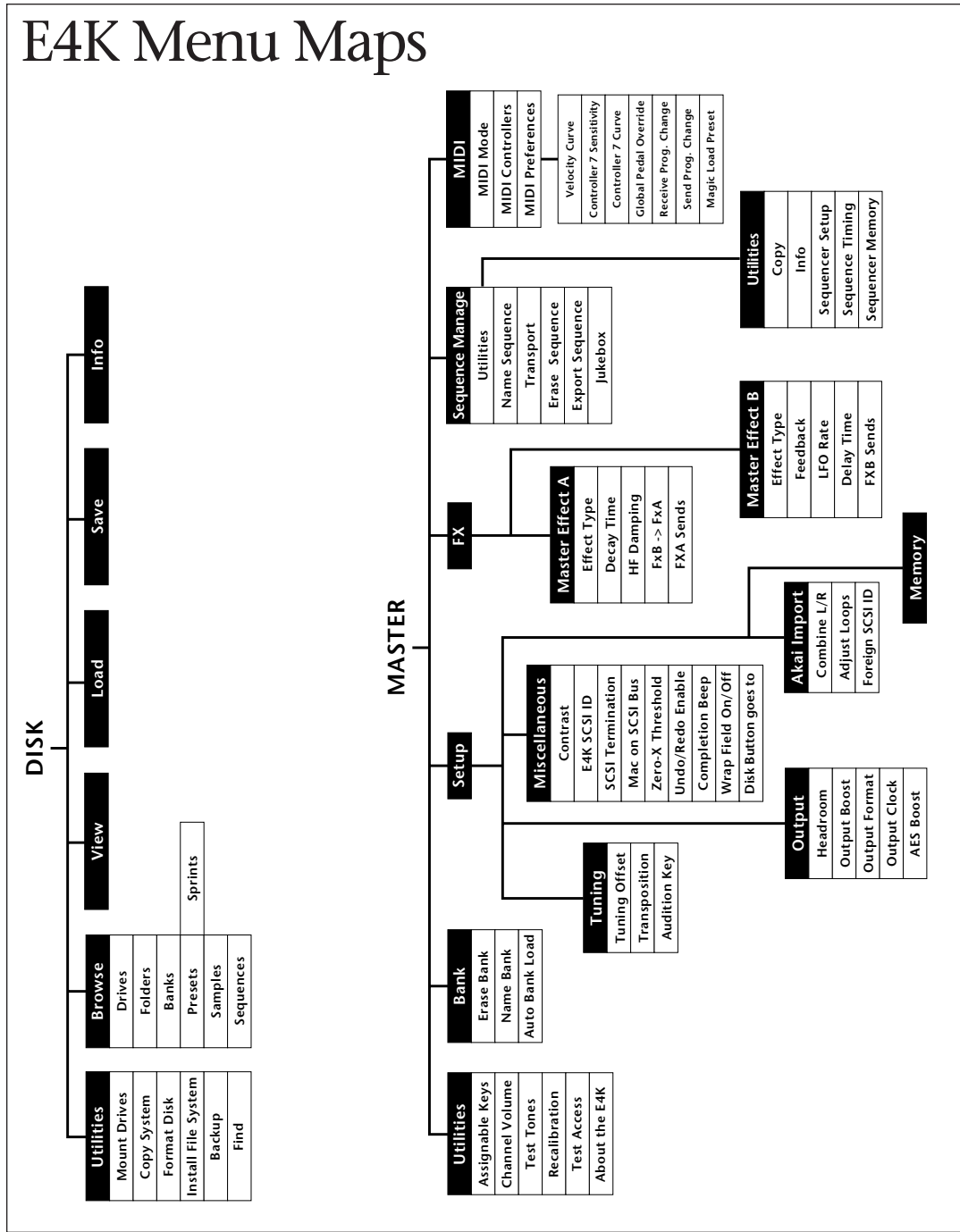

E4K Menu Maps

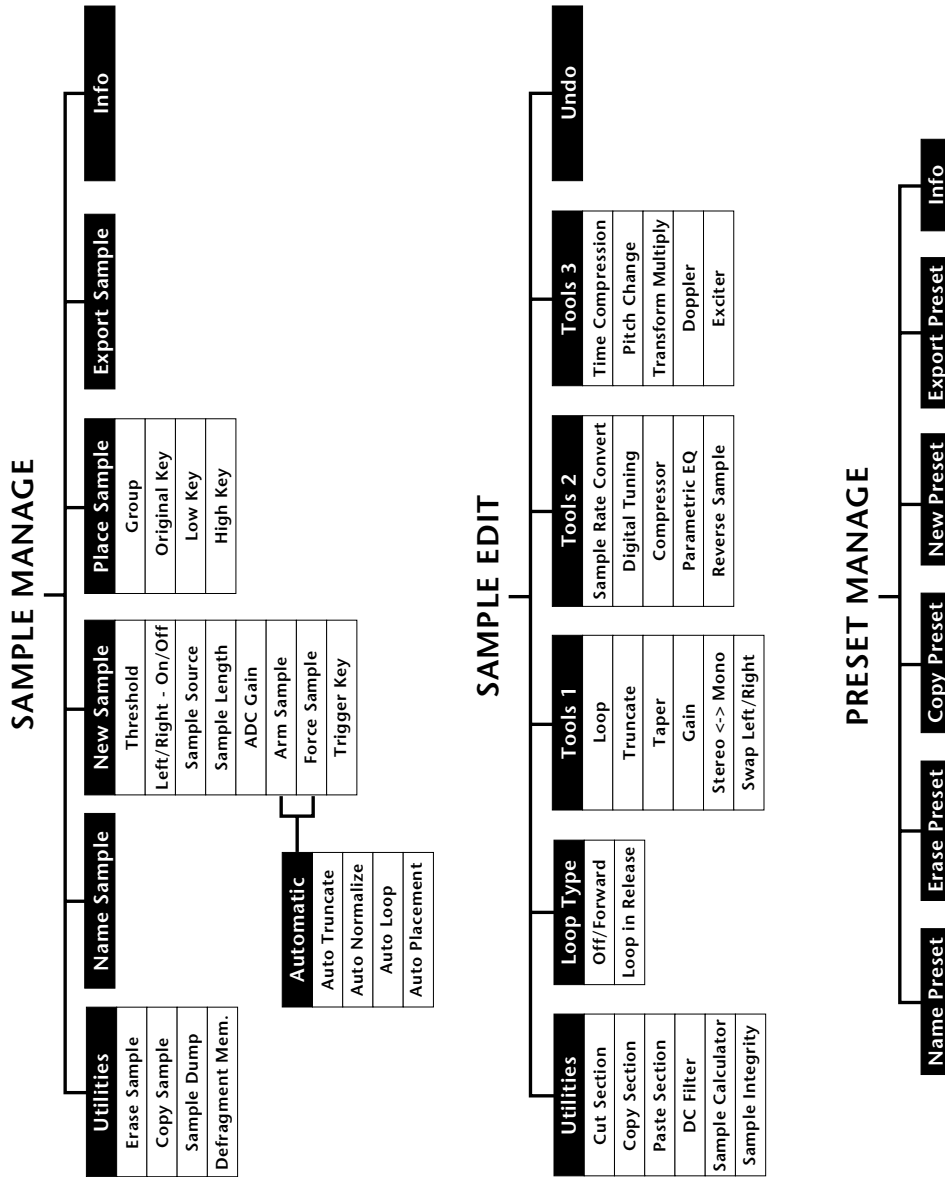

E4K Menu Maps

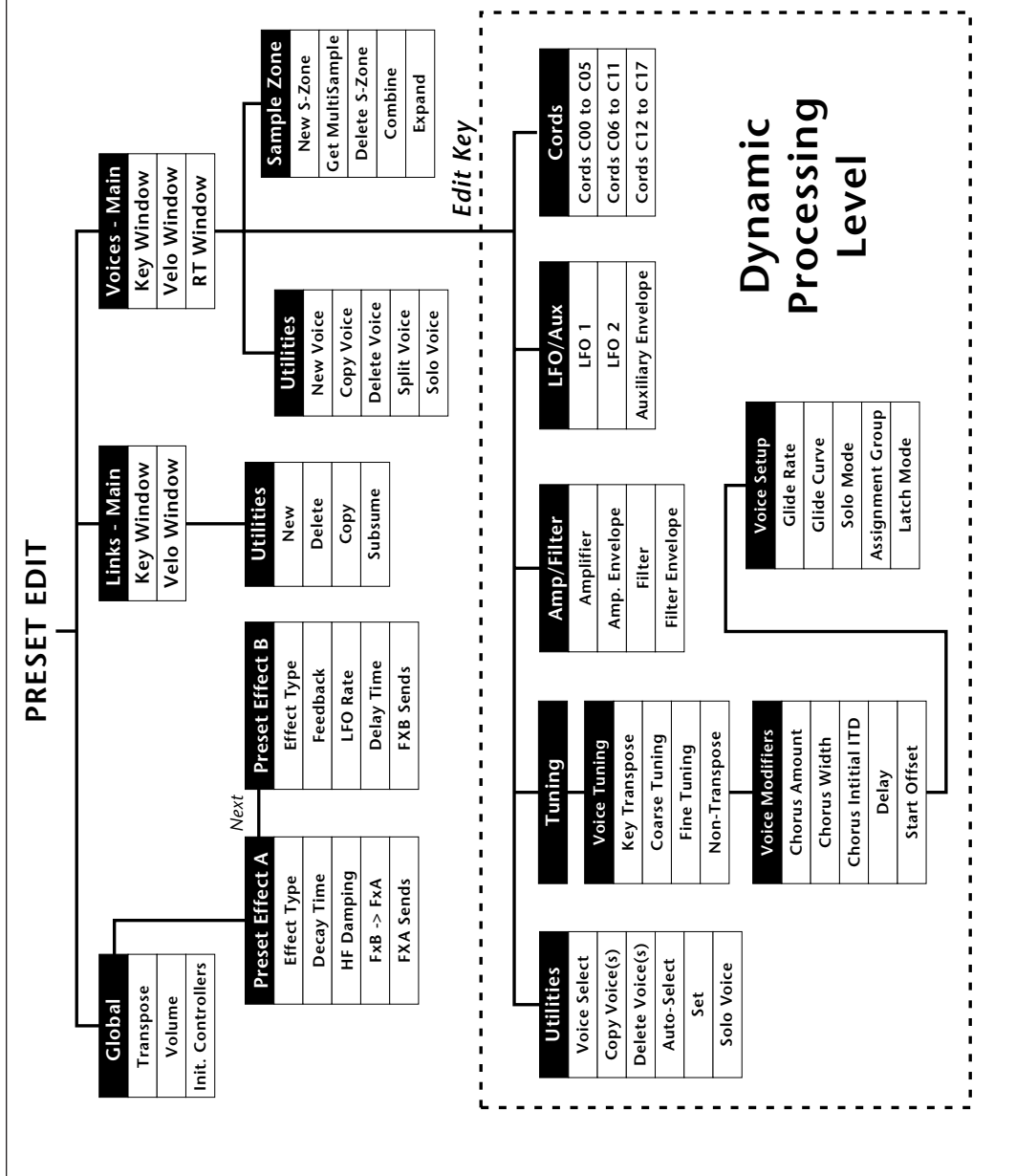

Memory Expansion

The memory of the E4K is user-expandable and consists of one or two SIMM RAM memory modules. (The front two sockets are for special E-mu ROM modules.) **Do not plug RAM SIMMs into these sockets!** The requirements for the SIMM modules are as follows:

- 72-pin SIMM (4 MB, 16 MB or 64MB)
- 8 or 9 bits (Mac or IBM)
- 70 nS or faster
- **No 8 MB or 32 MB SIMMs are allowed in the E4K!**
- The charts below show the allowable combinations of SIMMs. The standard E4K comes with (1) 4 MB SIMM installed. Either socket can be used when only one SIMM is installed.
- **If the SIMMs are of different size, the smaller SIMM will be divided in half.** That is, you will get only half of the memory of the smaller SIMM. You **MUST** install the larger SIMM in the slot towards the rear of the unit.

BEFORE YOU BEGIN, determine the proper locations of the SIMMs you plan to install.

<p>4 MB <i>Rear</i></p> <p>RAM 2 <input type="text" value="Empty"/></p> <p>RAM 1 <input type="text" value="4 MB"/></p> <p>ROM 1 <input type="text" value="DON'T USE"/></p> <p>ROM 2 <input type="text" value="DON'T USE"/></p>	<p>8 MB <i>Rear</i></p> <p>RAM 2 <input type="text" value="4 MB"/></p> <p>RAM 1 <input type="text" value="4 MB"/></p> <p>ROM 1 <input type="text" value="DON'T USE"/></p> <p>ROM 2 <input type="text" value="DON'T USE"/></p>	<p>16 MB <i>Rear</i></p> <p>RAM 2 <input type="text" value="16 MB"/></p> <p>RAM 1 <input type="text" value="Empty"/></p> <p>ROM 1 <input type="text" value="DON'T USE"/></p> <p>ROM 2 <input type="text" value="DON'T USE"/></p>	<p>18 MB <i>Rear</i></p> <p>RAM 2 <input type="text" value="16 MB"/></p> <p>RAM 1 <input type="text" value="4 MB"/></p> <p>ROM 1 <input type="text" value="DON'T USE"/></p> <p>ROM 2 <input type="text" value="DON'T USE"/></p>
<p>32 MB <i>Rear</i></p> <p>RAM 2 <input type="text" value="16 MB"/></p> <p>RAM 1 <input type="text" value="16 MB"/></p> <p>ROM 1 <input type="text" value="DON'T USE"/></p> <p>ROM 2 <input type="text" value="DON'T USE"/></p>	<p>64 MB <i>Rear</i></p> <p>RAM 2 <input type="text" value="Empty"/></p> <p>RAM 1 <input type="text" value="64 MB"/></p> <p>ROM 1 <input type="text" value="DON'T USE"/></p> <p>ROM 2 <input type="text" value="DON'T USE"/></p>	<p>72 MB <i>Rear</i></p> <p>RAM 2 <input type="text" value="64 MB"/></p> <p>RAM 1 <input type="text" value="16 MB"/></p> <p>ROM 1 <input type="text" value="DON'T USE"/></p> <p>ROM 2 <input type="text" value="DON'T USE"/></p>	<p>128 MB <i>Rear</i></p> <p>RAM 2 <input type="text" value="64 MB"/></p> <p>RAM 1 <input type="text" value="64 MB"/></p> <p>ROM 1 <input type="text" value="DON'T USE"/></p> <p>ROM 2 <input type="text" value="DON'T USE"/></p>

Groundwork

Before you begin, find a clean, well lit place in which to work.

UNPLUG THE AC CORD BEFORE WORKING ON E4K

This procedure requires that you periodically “Ground” yourself, by touching a grounded object such as a water pipe or a grounded piece of equipment. A good location might be your kitchen counter somewhat near the sink and the grounded water faucet. Grounding yourself prevents the static charge in your body from damaging the sensitive memory chips. When you are asked to “Ground” yourself, simply reach over and touch the metal on the water faucet. Do not walk across the room or across a rug, as this will defeat the purpose of grounding.

Tip: Use an end cap as a cup to hold the screws.

Disassembly

1. **Remove the End Caps:** To gain access to the interior of E4K, the end caps must first be removed. The two end caps are attached by means of (3) phillips head screws each. Looking directly at the end of the unit, you can see the three screws. The front screw is slightly shorter.

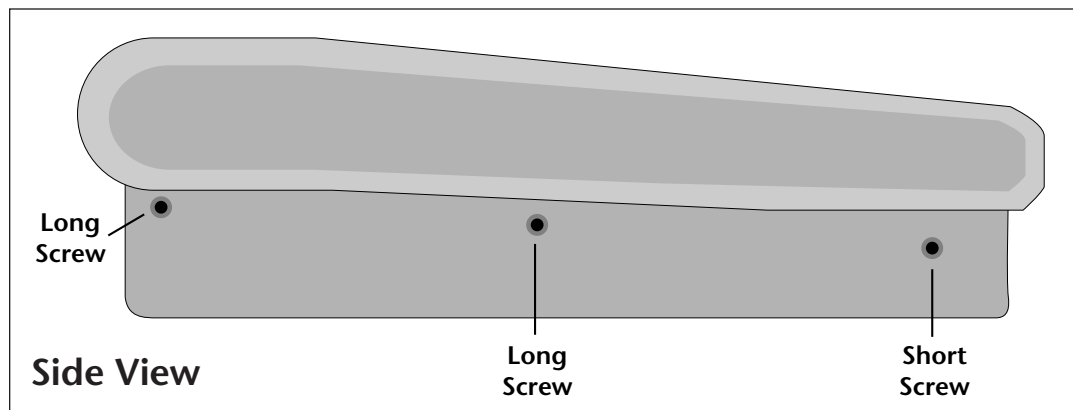

2. When the screws are removed (and set aside in a safe place), pull the end cap straight out from the end.
3. **Remove the Display Bezel:** There are two more screws located underneath the display bezel. Lift the **right** edge of the plastic bezel slightly with your fingernail, then slide the entire bezel assembly to the right. The bezel assembly should easily pop out.

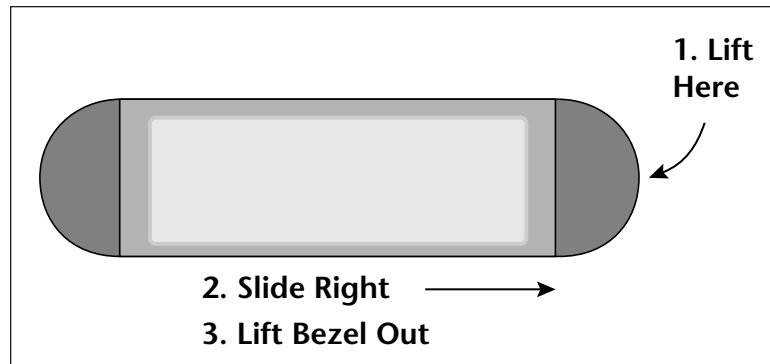

4. Remove the two screws on either side of the bezel and set them aside in a safe place.

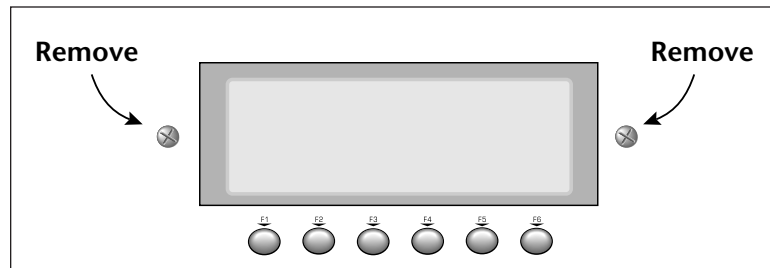

5. Remove the two phillips head screws on the sides of the display. Set these aside in a safe place.

6. There are three screws on each side of the control panel. Remove these six screws and set aside. Refer to the diagram below.

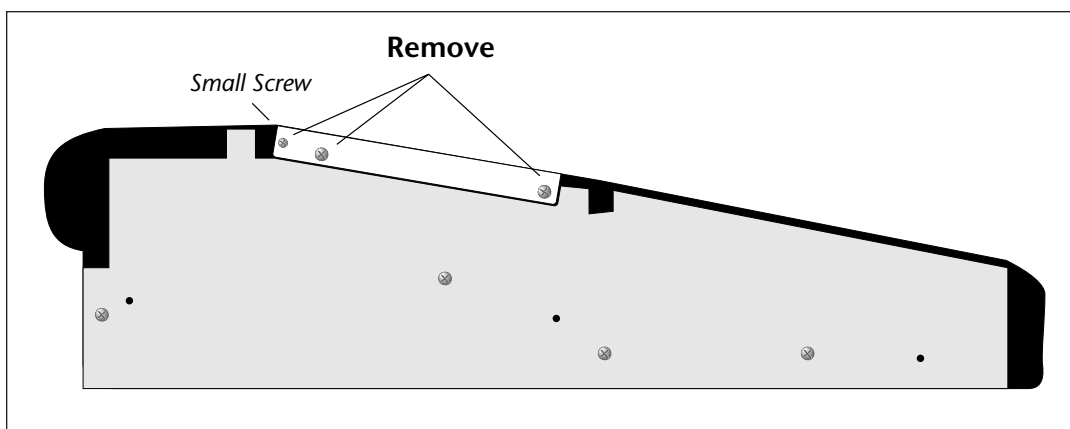

7. **Lift the Control Panel:** Lift the metal top FROM THE FRONT and lift off the panel assembly with cables still attached. Tilt the panel back and prop it up using the slot in the top of the metal extrusion. This slot holds the control panel propped up like an automobile hood.

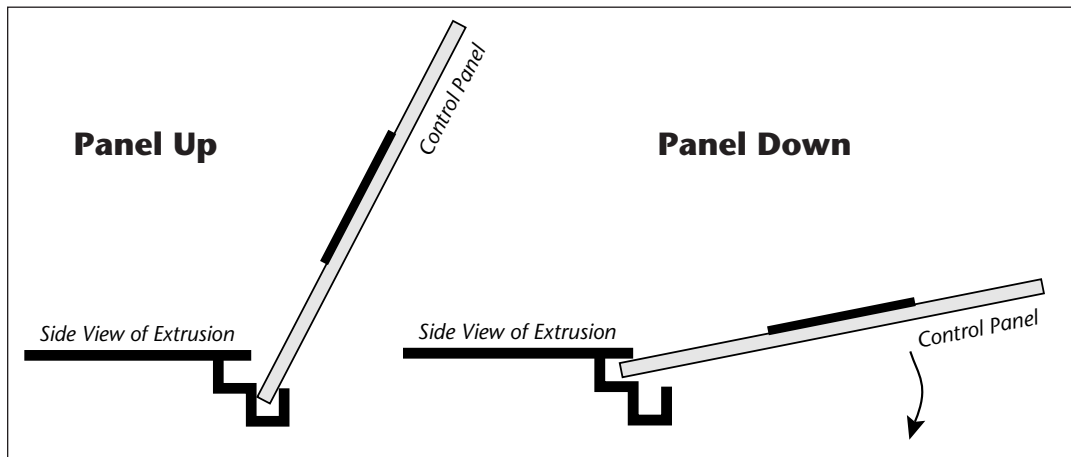

Remove the Old Memory SIMMs (if necessary)

The memory SIMMs are located near the center towards the keyboard. The front of the E4K should be facing you. To remove a SIMM:

1. Ground yourself by touching a grounded object.
2. On each end of the SIMM socket, facing toward the rear, there is a little plastic tab. Use a screwdriver or a ball point pen to squeeze the tabs toward the outside of the socket while gently pushing the SIMM toward the rear of the unit. The old SIMM should “hinge” backward and can now be removed.

Caution: The rear of the control panel is rimmed with little beryllium clips. Take care that these do not fall off inside the unit. If one falls off, simply clip it back in place.

Install the New Memory SIMMs

1. Ground yourself by touching a grounded object, then remove the memory SIMM modules from the static protected packaging.
2. Gently set the SIMM deep into the SIMM socket at a 45° angle. One end of the SIMM is notched. This notched end should be on the same side as the RAM 1 and RAM 2 labels. Without forcing the insertion, let the board rest in the socket **as deep as it will go**. See the diagram on the following page.

1. Insert the SIMM module as shown with the notch indicating PIN 1 on the label side of the socket.

The SIMM should fall naturally in place.

Appendix

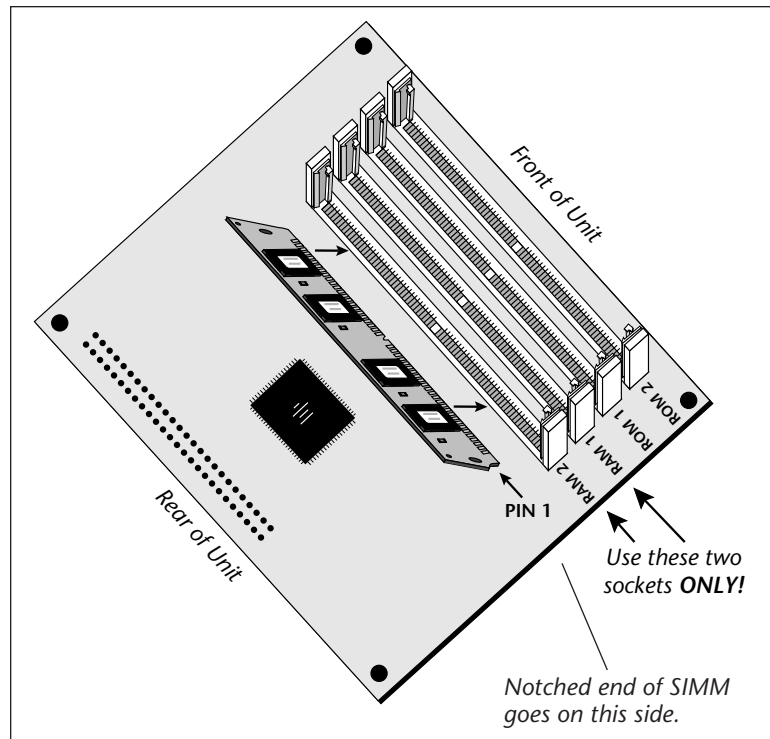

2. Tilt the SIMM into a vertical position. Both end tabs should lock.

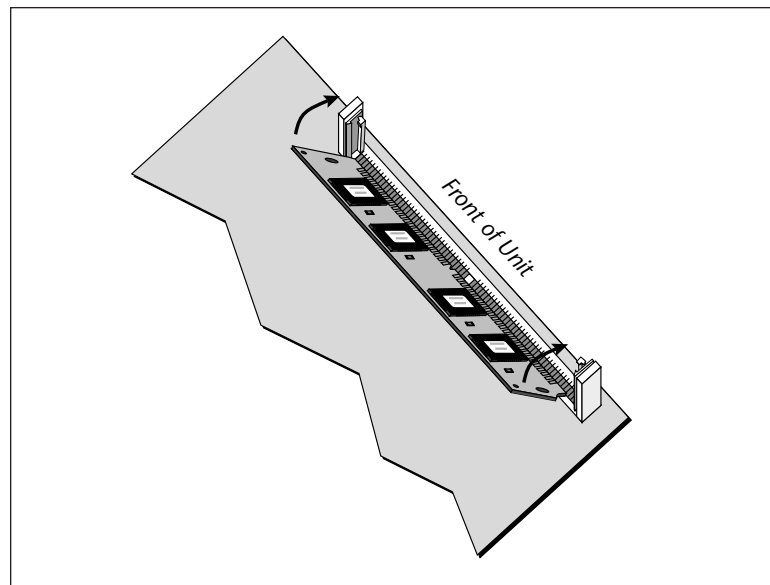

3. While applying a slight downward pressure on the top of the SIMM to keep it from popping out of the socket, tilt the SIMM board into a vertical position. You should hear an audible click. Make sure both sides of the plastic tabs have latched.

Reassemble the Unit

1. Lift the control panel out of the slot and slide the rear edge back into the horizontal slot in the rear extrusion. Align the control panel to the outer edges on each side of the unit.
2. Replace the two screws on either side of the display.
3. Replace the three screws on each end of the control panel. The small screw goes in the rear. You may have to adjust the control panel slightly so the screw holes line up.
4. Replace the end caps. The lip on the top of the end cap rests on top of the control panel. Reinstall the three screws on end. The short screw goes in front.
5. Replace the display bezel. Set the bezel in the slots with the two pins on the right bottom of the bezel. Slide the bezel to the left, then press down on the right side.

Test It

At this point, the installation is almost finished. Plug in the power cord and turn on power to the E4K. If the display boots up showing the new memory size, everything is probably OK.

If the unit comes up without showing the proper memory size, you may have installed the SIMMs incorrectly.

To Test Memory:

1. Activate the **Master** module.
2. Select **Utilities**.
3. Select **Tests**. A pop up window will appear asking you to enter the Diagnostics Password. Ah, you've got us now. We'll have to reveal the secret password after all. Enter the secret password: **1-3-5-8**, then press **OK**. Another row of soft keys will appear.

A Word of Warning: Now that you know how to get into the hidden diagnostics, be careful not to erase your hard disk by running the Automatic or Hard Disk tests!

4. Press the **RAM** soft key to begin testing memory. The display will warn you that the test destroys any data currently residing in RAM. Don't worry, this test does **NOT** affect your hard disk data. Press **OK** to continue.
5. CPU memory will be tested first (cRAM). After four cycles, the sound memory (gRAM) will be tested. Allow this test to run through at least four complete cycles or longer if you want. (This time will vary with the amount of RAM installed.)
6. Press **EXIT** to abort the test. Any errors will be displayed. If the memory tests bad, you may have incorrectly installed the SIMMs.

Problems?

Disconnect power, open the unit, and try re-seating the SIMMs. Check that both SIMMs are of the same type. If all else fails, return the E4K to its original configuration and call E-mu Customer Service at (408) 438-1921. Telephone support hours are 8:00-5:00 PST, Monday through Friday.

Specifications

Number of Voices	64 or 128, depending on model (expandable)
Sound Memory	4 MB standard, expandable to 128 MB
Output Sample Rate.....	44.1 kHz, 48 kHz
Main Outputs	2 balanced 1/4" jacks
Submix Outputs	6 unbalanced 1/4" stereo jacks, (tip = output, ring = sub input, analog summed into main outputs.)
Output Level	-2 dBu nominal
Output Impedance	50 Ω , will drive 600 Ω load
Analog Inputs	2 balanced 1/4" jacks, TRS
Input Impedance	4 K Ω
Input Gain Scaling	-10 to +50 dB
Data Encoding	Input: 16-bit Sigma-Delta, 128x oversampling Output: 18-bits
Digital I/O	S/PDIF or AES/EBU format, RCA connectors
Keyboard	76-note weighted, velocity and pressure sensitive
ASCII Keyboard	ASCII keyboard connector
External Controllers	Footswitch and control pedal inputs, 1/4" jacks
SCSI.....	50-pin connector, active termination
Sample Rates	Analog: 48, 44.1, 24, 22.05 kHz; Digital: 48, 44.1, 32 kHz.
Pitch Shift Range	\pm 5 octaves, constant sample rate technology
Frequency Response.....	20 Hz to 20 kHz, +2/-1 dB
Signal to Noise Ratio	>90 dB
Signal/Quiescent Noise ..	>100 dB
THD + Noise	Less than 0.02% (1 kHz sine wave, A-weighting)
Stereo Phase	Phase Coherent \pm 1 $^\circ$ at 1 kHz
ASCII KYBD Interface	PC-AT style ASCII keyboard
Weight	35 pounds (16 kg)
Dimensions	W - 13.5" (39.3 cm), H - 4.1" (10.4 cm), L - 49.2" (125 cm)
Power	100-240 VAC, 50/60 Hz, auto-select, < 50 watts

Warranty

Please read this warranty, as it gives you specific legal rights.

Length of Warranty

Your E4K warranty covers all defects in materials and workmanship for a period of one year (90 days for disk drives) from the date of purchase by the original owner, provided that the Warranty Registration Card is filled out and returned to E-mu Systems within 14 days from the date of purchase. Cases may arise where E-mu's Service Department or one of E-mu's authorized service centers will ask for a copy of your sales receipt to facilitate warranty service. Please keep your purchase receipt in a safe place.

E-mu Systems does not cover:

- Damages due to improper or inadequate maintenance, accident, abuse, misuse, alteration, unauthorized repairs, tampering, or failure to follow normal operating procedures as outlined in the owner's manual.
- Deterioration or damage of the cabinet.
- Damages occurring during any shipment of the E4K for any reason.
- An E4K that has in any way been modified by anyone other than E-mu Systems, Inc.

Limitation of Implied Warranties

No warranty is expressed or implied. E-mu Systems specifically disclaims the implied warranties of merchantability and fitness for a particular purpose.

Exclusion of Certain Damages

E-mu Systems' liability for an E4K found defective is limited to repair or replacement of the unit at E-mu's option. In no event shall E-mu Systems be liable for damages based on inconvenience, whether incidental or consequential, loss of use of the unit, loss of time, interrupted operation or commercial loss, or any other consequential damages.

Some states do not allow limitation of the duration of implied warranties or the exclusion or limitation of incidental or consequential damages, so the above limitations and exclusions may not apply to you.

How To Obtain Warranty Service

All E-mu products are manufactured with the highest standards of quality. If you find that your instrument does require service, it may be done by any authorized E-mu service center. If you are unable to locate a service center in your area, please contact E-mu Systems Service Department at (408) 438-1921. They will either refer you to an authorized service center or ask that you return your E4K to the factory. When returning an E4K to the factory, you will be issued a Return Merchandise Authorization number (RMA). Please label all cartons, shipping documents and correspondence with this number. E-mu suggests you carefully and securely pack your E4K for return to the factory. (*Do not send the power cord or operation manual.*) Mark the outside of the shipping carton clearly with your RMA number. Send to E-mu Systems, Inc. 1600 Green Hills Road, Scotts Valley, California, 95066. You must pre-pay shipping charges to E-mu Systems. E-mu will pay return shipping fees. You will be responsible for any damage or loss sustained during shipment in any direction.



Index

Symbols

2-pole filter 261
 4-pole filter 261
 4x Gain 252

A

Absolute Value 252
 AC Power Connection 14
 Activating a Module 30
 ADC Gain 167
 Adjust Fractional Loops 101
 AES Boost 92
 AES/EBU 14
 Aftertouch 246
 Akai Import 100
 Amp/Filter Modules 310
 Amplifier Envelope 329
 Amplifier Parameters 328
 Arm Sampling 169
 ASCII Keyboard Interface 15
 Assign Group 327
 Assign Voices to Group 327
 Assignable Keys 8, 78
 Audition Key 87
 Audition, sample 70
 Auto
 Bank Load 84
 Correlation 188
 Loop 172
 Multisample 173, 174
 Normalize 171
 Repeat 228
 Truncate 171
 Voice Selection 318
 Auto/Manual Indicator 310
 Auxiliary Envelope 338

B

Backup & Restore 48
 Bandpass 331
 Bandpass Filter 260
 Bandwidth, para EQ 221
 Bank 57
 Bank, definition 27
 Bank Info 61
 Bank Utilities 57, 71
 Basic MIDI Channel 110
 Below, compressor 216
 B into A, effect 129
 Body Size 330, 332
 Bookmarks 64

C

CD-ROM Drive 29
 Center Freq, EQ 221
 Channel Volume 79
 Chorus, effect 138
 Chorus, doubling 322
 Clipboard 185
 Clipping 88, 90
 Coarse Tuning 320
 Combine 295
 Combine L/R 100
 Compress Loop 205
 Compression Ratio 217
 Compressor 215
 Continuous Controller 117, 118
 Contour 248
 Contrast 93
 Controller #7 Sensitivity: 120
 Controller Wheels 7
 Controls/FX Access Key 8

- Copy 315, 317, 318
 - Background 185
 - Link 282
 - Preset 238
 - Sample 161
 - Section 193
 - Sequence 143
 - System 46
 - Voice 289
 - Voice(s) 315
- Cord 247, 250, 340
- Cords module 310
- Creamy, digital tuning 214
- Creamy, s/r convert 213
- Create Preset 239
- Create Sample 165
- Crossfade Loop 184, 205
- Crossfade Random 250, 307
- Crossfade Type 205
- Crunchy, digital tuning 214
- Crunchy, s/r convert 213
- Cursor, definition 32
- Cursor Keys 10
- Cut, background 185
- Cut Section 191

D

- Data Entry Control 12
- DC Filter 198
- Decay Time 137
- Decay Time, preset fx 274
- Default 32
- Definitions 22
- Defragment Memory 163
- Delay, effect 140
- Delay, voice 322, 323
- Delay Time, preset fx 278
- Delete
 - Bank 58
 - Folder 54
 - Link 282
 - Sample Zone 294
 - Voice 290
 - Voice(s) 317
- Diagnostics 82
- Digital Interface 14
- Digital Output Level 92

- Digital Tuning 214
- Dimensions 361
- Diode 252
- Disk Browser 40
- Disk Button Goes To: 99
- Disk Info 52
- Disk Utilities 45
- Display View 52, 56, 72
- Doppler 227
- Doubling 139
- Duration, doppler 228
- Dynamic Processing Level 308

E

- EIIIIX, export sample 175
- E4K SCSI ID 94
- Early Reflection, reverb 138
- Edit All 270
- Editing Presets 244
- Effects 128
 - Amount, preset 275, 279
 - Bus 127
 - Bypass 135
 - Control 113, 130
 - Control Channel 113, 134
 - Only mix
 - Sends 127
 - Types 105, 106, 136
 - Type, preset 273, 277
- Enter Key 10
- Envelope Generators 246, 248
- Equal Power Mix 196
- Erase
 - Bank 83
 - Preset 237
 - Sample 160
 - Sequence 153
- Exciter 230
- Exit key 10
- Expand, voices 296
- Expansion, dyn. range 217
- Export sequence 154
- Expression 333
- External Drives 18, 28

F

Fade In/Out, exciter 230
 Feedback, effects 140
 Feedback Amount, preset fx 277
 Filter 258
 Envelope 335
 Parameters 330
 Type 330
 Find
 Bank 59
 Folder 55
 Preset 66, 72
 Sample 68
 Fine Tuning 321
 Fingered Glide 325
 Flanger, effect 139
 Flanger, filter 332
 Flip-flop
 footswitch 340
 mod. processor 252
 Floppy Disk Drive 28
 Folder 53
 Definition 27
 Info: 56
 Utilities 53
 Footpedal Input 16
 Footswitch Inputs 16
 Footswitch assign 246
 Force Sampling 169, 170, 174
 Foreign Sampler SCSI ID 101
 Format Disk 47
 Formatting a hard disk 18
 Fragmented Memory 163
 Function Keys 10

G

Gain, para EQ 221
 Gain Change 209
 Gate 246
 Get Info, sample 177
 Get Info, preset 241
 Get Multisample 293
 Glide Rate & Curve 324
 Global Editor 270
 Global Effects 104, 132
 Global Pedal Override 121
 Groups 266

H

Hall, effect 138
 Hard Disk Drive 28, 29
 Headphone Output 17
 Headroom 88
 HF Damping, preset fx 274
 High Frequency Damping 137
 High Pass Filter 260
 Highpass 331

I

Icon, definition 32
 Import Options 100
 Inc/Dec Keys 12
 Includes 314
 Insert 196
 Install File System 48
 Inter-Aural Time Delay 322
 Isolate 313
 Isolate Key 315
 ITD 322

K

Keep, sample 171
 Key Glide 246
 Key Random 250
 Key Transpose 319
 Key Velocity 246
 Keyboard Key 246
 Keyboard Pressure 246
 Keyboard Ranges 298

L

Lag Processors 252, 337
 Latch mode 326
 LFO 140, 249
 Delay 336
 Rate, preset fx 278
 Sync 336
 Variation 336
 LFO/Aux modules 310
 Limiter 219
 Linear Mix 196

- Link
 - Controls 280
 - Field 280, 284
 - Key Position 284
 - Preset Name 280, 284
 - Utilities 280, 284
 - Velocity Range 286
 - Velocity Window 286
 - Key Window 284
 - Velocity Controls 286
- Load
 - Bank 50, 59
 - Preset 66
 - Sample 70, 73
 - Standard MIDI File 74
- Loading a Bank 34
- Local Control 112
- Lock Drive 52
- Lock Key 12, 65
- Loop
 - Compression 184
 - Description 182
 - In Release 201
 - Points 203
 - Type 201
- Low Freq. Oscillator 246, 249
- Low Pass Filter 259
- Lowpass 331

M

- Mac on SCSI Bus 95
- Magic Load Preset 122
- Magneto-Optical Drive 29
- Main Outputs 16
- Master Effects 103, 132
- Master Effects in Multi Mode 132
- Melody, solo mode 325
- Memory
 - Adjust 102
 - Configuration 102
 - Expansion 354
 - Test 359
- Meter, sequencer 146

- MIDI
 - Connection 14
 - Continuous Controller 117
 - Controller #7 Sens. 120
 - Controllers 118
 - Globals 109
 - Indicator LED 9
 - Mix 36, 115
 - Mix, adjusting 37
 - Mode 111
 - Sample Dump 161
- Miscellaneous 93
- Misc. Controllers A & B 246
- Modifiers 319
- Modulation 245
 - Cords 247
 - Destinations 250, 251, 339
 - Processors 252, 254
 - Sources 246, 251, 339
- Module Select Keys 9
- Modules 30
- Monitor on/off 169
- Mono A-I 325, 327
- Morphing Filter 332
- Mount Drives 46
- Multi Mode 111
- Multiple trig., solo 325
- Multisample 298
- Musical Compression 219

N

- Name
 - Bank 84
 - Preset 236
 - Sequence 148
 - Folder 54
- New
 - Folder 54
 - Link 281
 - Preset 239
 - Sample 165
 - Sample Zone 293
 - Voice 289
- Noise/Random Generators 246, 250, 256



Noise Reduction 219
 Non-transpose Mode 321
 Normalize 210
 Normalize After 228
 Notch Filter 260
 Numeric keys 11

O

Omni Mode 111
 Option Port 14
 Output
 Boost 90
 Clock 92
 Clock Rate 92
 Format 90, 91

P

Page Select Keys 11
 Pan 328
 Parametric Equalizer 220
 Parametric Filters 262
 Paste, background 185
 Paste Section 194
 Peak 216
 Pedal 246
 Phaser, filter 332
 Pitch & Mod Wheels 246
 Place Sample 175
 Plate, reverb 138
 Poles, filter 261
 Poly All 325, 327
 Poly Mode, MIDI 111
 Positional Cross-switch 299
 Positional Crossfade 285, 300, 301
 Power 361
 Presampling 168
 Preset 62
 Definition 26
 Effects A 271
 Effects B 276
 Info 67
 Programming Effects 271

Q

Q 260, 330
 Quantizer 252

R

Random Sources 250
 Real Time Faders 8
 Realtime Crossfade
 305, 306, 307
 Recalibration 80
 Recording SysEx 153
 Redo 97, 186, 231
 Reference Tone 80
 Removable Media Drives 29
 Rename Bank 58
 Rename Folder 54
 Replace Multisample 294
 Replace multisample 294
 Resampling 166
 Resonance, filter 260, 330
 Restore 48
 Retrigger, sample 341
 Reverberation 137, 138
 Reverse Section 222
 RMS 216
 Roland, import 100
 Room, reverb 138

S

S/PDIF 14
 Sample 23, 68
 Basics 20
 Calculator 199
 Dump 161
 Edit, definition 23
 Info 70, 73
 Inputs 16
 Integrity 200
 Length 168
 Process 182
 Rate 166
 Rate Convert 212
 Rate, output 92
 Retrigger 341
 Source 166
 Threshold 168
 Save Bank 51, 60
 Sawtooth, wave 249
 Scrub Wheel 187

SCSI 345
 ID, changing 94
 ID number 346
 Port 13
 Problems 348
 Termination On/Off 94
 Select
 Voice 314
 Voice(s) 264
 All Voices 265
 Multimode 36
 Presets 36
 Send Prog. Change On/Off 122
 Sequencer
 Clock type 145
 Controls 142
 Definition 40
 Info 73, 144
 Jukebox 156
 Loop Mode 145
 Manage 141
 Manage Key 8
 Memory 147
 Recording 151
 Record Mode 145
 Timing 146
 Transport 142, 148
 Transport Controls 9, 142
 Set 318
 Set Key 12
 Signal Path 309
 Sine, wave 249
 Slapback, effect 139
 SMDI 349
 Smooth, digital tuning 214
 Smooth, s/r convert 213
 Soft-Keys 10
 Software Version 82
 Solo mode 325
 Solo Voice 292
 SoundSprint 41, 62
 Definition 26
 Loading 34
 Specifications 361

 Split, keyboard 290
 Square, wave 249
 Standard MIDI Files 154
 Start Offset 323
 Stereo <-> Mono 211
 Stereo Width, chorus 322
 Submix 328
 Submix Outputs 17
 Subsume Link 283
 Summing Amp 252
 Swap Left & Right 211
 Swept EQ 331
 Switch, mod. proc. 252
 Synth, solo mode 325
 SysEx 153

T
 Taper 207
 Target group 173
 Target preset 173
 Tempo 146
 Termination 94, 347
 Test Access 82
 Threshold 168, 216
 Thumbby Button 7
 Time Compression 224
 Tones, reference 80
 Track Status, sequence 149
 Transform Mult. 226
 Transpose 87
 Transpose & Volume 270
 Transposition, def. 23
 Tremolo 250
 Triangle, wave 249
 Truncate: (after loop) 205
 Truncation 206

Tuning
 Master 86
 Digital 214
 Exciter 230
 Modules 310
 Offset 86

U

Undo 97, 186, 231
Up Velocity 246
Update Software 28, 46
Utilities
 Disk 45
 Dynamic Proc. 311
 Links 280
 Sample Edit 190
 Sample Manage 160
 Sequencer 143
 Voices 288

V

Velocity
 Crossfade 287, 304
 Curves 119
 Range 286, 303
 Switch 303
Vibrato, effect 140
Vibrato, modulation 250
View, display 52
Viewing Angle, LCD 93
Vocal Filters 332
Voice
 Definition 23
 Key Window 297
 Main Controls 288
 Number 288
 Realtime Window 305
 Select 312
 Utilities 289
 Velocity Window 302
Volume 328

W

Warranty 362
Weight 361
What is a Filter? 259

White Key, voice 174
Wrap Field Selection 98

X

Xfade amp 251, 306
Xfade random 251, 307

Z

Z-Plane Filter 258, 262
Zero Crossing 188
Zero Crossing Threshold 95
Zone Selection 313
Zoom 204