

# MONOMACHINE

SFX-6/SFX-60/SFX-60 MKII/SFX-60+ MKII

USER'S MANUAL

### **FCC compliance statement**

This device complies with part 15 of the FCC rules. Operation is subject to the following two conditions: (1) This device may not cause harmful interference, and (2) this device must accept any interference received, including interference that may cause undesired operation.

NOTE: This equipment has been tested and found to comply with the limits for a Class B digital device, pursuant to Part 15 of the FCC Rules. These limits are designed to provide reasonable protection against harmful interference in a residential installation. This equipment generates, uses and can radiate radio frequency energy and, if not installed and used in accordance with the instructions, may cause harmful interference to radio communications. However, there is no guarantee that interference will not occur in a particular installation. If this equipment does cause harmful interference to radio or television reception, which can be determined by turning the equipment off and on, the user is encouraged to try to correct the interference by one or more of the following measures:

- Reorient or relocate the receiving antenna.
- Increase the separation between the equipment and receiver.
- Connect the equipment into an outlet on a circuit different from that to which the receiver is connected.
- Consult the dealer or an experienced radio/TV technician for help.

### **European Union regulation compliance statement**

This product has been tested to comply with the 2004/108/EC EMC Directive and the 72/23/EC Low Voltage directive.

This symbol indicates that your product must be disposed of properly according to local laws and regulations.



The included switched-mode power supply is CEC Level IV compliant.

The device contains a non-rechargeable lithium perchlorate battery cell that may need to be recycled separately depending on local environmental laws. If the battery needs replacing, please contact Elektron or a local professional technician for servicing.

---

<b>INTRODUCTION</b> .....	<b>1-1</b>
CONVENTIONS IN THIS MANUAL.....	1-1
<b>THE PHILOSOPHY OF THE MONOMACHINE</b> .....	<b>1-2</b>
KEEP IN MIND .....	1-2
HIGHLIGHTS.....	1-2
+DRIVE FEATURES.....	1-3
<b>USER INTERFACE AND CONNECTORS</b> .....	<b>1-4</b>
FRONT / MAIN CONTROL PANEL .....	1-4
KEYBOARD INTERFACE, SFX-6.....	1-6
REAR CONNECTORS .....	1-7
ADDITIONAL REAR CONNECTORS, SFX-6.....	1-8
RACK MOUNT KIT .....	1-8
RACK MOUNT KIT ASSEMBLY.....	1-8
CONNECTING THE UNIT .....	1-8
CARE INSTRUCTIONS.....	1-9
<b>THE LCD USER INTERFACE</b> .....	<b>1-10</b>
LAYER EDIT AND WINDOWS .....	1-10
<b>QUICK START</b> .....	<b>1-11</b>
SELECTING AND PLAYING A PATTERN.....	1-11
PLAYING IN MULTI TRIG MODE.....	1-12
EXPLORING A PATTERN .....	1-12
DIFFERENT TYPES OF RECORDING.....	1-12
OVERVIEW OF GRID RECORDING MODE.....	1-12
OVERVIEW OF LIVE RECORDING MODE.....	1-13
PARAMETER LOCKS .....	1-13
<b>MONOMACHINE OVERVIEW</b> .....	<b>1-15</b>
CHOOSE YOUR WAY OF WORKING.....	1-15
SIX INDIVIDUAL TRACKS .....	1-15
SIX TRACK SEQUENCING.....	1-15
MIDI SEQUENCING .....	1-15
POLY MODE.....	1-15
MULTI TRIG MODE.....	1-15
MULTI MAP MODE.....	1-15
<b>MONOMACHINE SYNTHESIS ARRANGEMENT</b> .....	<b>1-17</b>
MONOMACHINE KITS .....	1-18
THE LINK BETWEEN KITS AND PATTERNS.....	1-18
LOADING A KIT.....	1-19
LOADING AN EMPTY KIT.....	1-19
SAVING AND NAMING A KIT .....	1-19
UNDO KIT.....	1-20
COPY KIT .....	1-21
CLEAR KIT .....	1-21
KIT EDITING.....	1-22
ASSIGNING A MACHINE TO A TRACK .....	1-22
COPY MACHINE .....	1-23
CLEAR MACHINE .....	1-24
SETTING THE MIX BUS .....	1-24
PARAMETER EDITING .....	1-25
<b>TRACK EFFECTS</b> .....	<b>1-26</b>
LEVEL.....	1-26

---



---

AMPLIFICATION PAGE .....	1-26
AMPLIFIER ENVELOPE.....	1-26
DISTORTION.....	1-27
TRACK VOLUME.....	1-28
PAN.....	1-29
PORTAMENTO.....	1-29
FILTER PAGE .....	1-29
BASIC FILTER CONTROLS .....	1-30
FILTER ENVELOPE .....	1-31
FILTER TRACKING .....	1-31
EFFECTS PAGE.....	1-32
EQ.....	1-32
SAMPLE RATE REDUCTION.....	1-32
DELAY .....	1-33
<b>LOW FREQUENCY OSCILLATORS.....</b>	<b>1-35</b>
LFO CONTROLS.....	1-35
<b>ADDITIONAL KIT SETTINGS .....</b>	<b>1-38</b>
ASSIGN .....	1-38
JOYSTICK .....	1-39
VELOCITY .....	1-39
KEY TRACKING .....	1-40
TRIG TRACK SETTINGS .....	1-40
MULTI TRIG.....	1-41
MULTI ENV .....	1-43
<b>THE PATTERN SEQUENCER.....</b>	<b>1-45</b>
BASIC PATTERN OPERATION .....	1-45
PATTERN SELECTION .....	1-45
PATTERN CHAINING .....	1-46
SCALE SETUP .....	1-46
COMPOSING A PATTERN .....	1-47
RECORDING PREPARATIONS .....	1-47
GRID RECORDING.....	1-47
LIVE RECORDING.....	1-49
STEP RECORDING.....	1-50
NOTE COPY.....	1-50
CLEAR NOTE PARAMETER LOCKS.....	1-50
TRACK PAGE COPY.....	1-51
CLEAR TRACK PAGE.....	1-51
TRACK COPY.....	1-52
CLEAR TRACK.....	1-53
PATTERN COPY .....	1-53
CLEAR PATTERN.....	1-54
SUPER COPY .....	1-54
SUPER CLEAR.....	1-55
TEMPO .....	1-55
THE TEMPO SCREEN .....	1-56
TAP TEMPO .....	1-56
EXTERNAL SYNCHRONISATION .....	1-56
PARAMETER LOCKS.....	1-57
PARAMETER LOCKS IN GRID RECORDING MODE .....	1-57
PARAMETER LOCKS IN LIVE RECORDING MODE .....	1-58
ADVANCED SEQUENCER CONTROL.....	1-58

---

---

TRIG TRACKS.....	1-58
TRIGLESS TRIGS.....	1-59
PITCHLESS TRIGS.....	1-59
<b>ADDITIONAL SEQUENCER FEATURES .....</b>	<b>1-61</b>
THE ARPEGGIATOR.....	1-61
ARPEGGIATOR BASIC SETTINGS.....	1-61
ARPEGGIATOR ENVELOPE TRIGGERING SWITCHES.....	1-62
ARPEGGIATOR RHYTHM AND OFFSET TRACK .....	1-63
TRANPOSE.....	1-63
SWING.....	1-64
THE SWING TRACK .....	1-65
SLIDE .....	1-66
THE MUTE MODE.....	1-67
MINIMISING THE MUTE WINDOW .....	1-68
POLY MODE.....	1-69
<b>THE MIDI SEQUENCER.....</b>	<b>1-70</b>
USING THE MIDI SEQUENCER.....	1-70
THE MAIN MIDI SEQUENCER INTERFACE .....	1-71
COMPARISON WITH THE INTERNAL SEQUENCER .....	1-71
<b>THE SONG MODE.....</b>	<b>1-73</b>
LOAD SONG .....	1-73
SAVE SONG.....	1-74
SONG PLAY .....	1-75
SONG TRANSPORT .....	1-75
SONG EDITING.....	1-76
SONG EDIT TRANSPORT .....	1-77
SONG LOOPS.....	1-78
SONG JUMP .....	1-78
SONG HALT .....	1-78
SONG TRACK TRANSPOSE.....	1-79
SONG EXTRA .....	1-79
<b>MONOMACHINE ROUTING.....</b>	<b>1-81</b>
THE MONOMACHINE MIXER .....	1-81
THE FX MACHINES.....	1-81
USING THE AUDIO INPUTS.....	1-82
NEIGHBOUR ROUTING .....	1-83
MIX BUS ROUTING .....	1-84
ROUTING MODE AB=MIX .....	1-85
ROUTING MODE 6xMONO .....	1-85
<b>GLOBAL SETTINGS .....</b>	<b>1-87</b>
TURBO MENU.....	1-87
AUDIO .....	1-88
MASTER TUNE .....	1-88
ROUTING .....	1-89
CONTROL .....	1-89
MIDI CHANNELS.....	1-89
MORE ON THE MONOMACHINE MIDI FUNCTIONALITY .....	1-90
CONTROL OUT1.....	1-91
CONTROL OUT2.....	1-92
CONTROL IN.....	1-92
MULTI MAP EDIT .....	1-93

---



---

MECHANICAL SETTINGS .....	1-94
FILE .....	1-95
SYSEX SEND .....	1-95
SYSEX RECEIVE .....	1-97
DIGIPRO MANAGER (MKII UNITS ONLY) .....	1-99
RECEIVE WAVEFORMS .....	1-100
SEND WAVEFORMS .....	1-102
ERASE WAVEFORMS .....	1-103
RENAME WAVEFORMS .....	1-104
+DRIVE SETTINGS (+DRIVE UNITS ONLY) .....	1-105
SNAPSHOT MANAGER (+DRIVE UNITS ONLY) .....	1-106
DIGIBANK MANAGER (MKII +DRIVE UNITS ONLY) .....	1-107
MIDI SEQ .....	1-108
MIDI SEQ SETTINGS .....	1-108
<b>EARLY STARTUP MENU .....</b>	<b>1-110</b>
TEST MODE .....	1-110
EMPTY RESET .....	1-110
FACTORY RESET .....	1-110
SOFT RESET .....	1-111
MIDI UPGRADE .....	1-111
SEND UPGRADE .....	1-111
<b>TECHNICAL INFORMATION .....</b>	<b>1-113</b>
SPECIFICATIONS .....	1-113
<b>DIFFERENCES BETWEEN THE MKI AND MKII MODELS .....</b>	<b>1-114</b>
DESIGN .....	1-114
POWER SUPPLY .....	1-114
SNR RATIO AND OUTPUTS .....	1-114
USER WAVEFORMS .....	1-114
<b>CREDITS .....</b>	<b>1-115</b>
PRODUCT DESIGN AND DEVELOPMENT .....	1-115
INDUSTRIAL DESIGN .....	1-115
ADDITIONAL DESIGN .....	1-115
USER'S MANUAL .....	1-115
FACTORY DEFAULT SOUND DESIGN .....	1-115
FACTORY WAVEFORMS .....	1-115
<b>CONTACT INFORMATION .....</b>	<b>1-116</b>
ELEKTRON WEBSITE .....	1-116
POSTAL ADDRESS .....	1-116
TELEPHONE .....	1-116
<b>APPENDIX A: MACHINE REFERENCE</b>	
<b>SUPERWAVE .....</b>	<b>A-1</b>
SUPERWAVE SAW "SWAVE-SAW" .....	A-1
SUPERWAVE PULSE "SWAVE-PULSE" .....	A-2
SUPERWAVE ENSEMBLE "SWAVE-ENS" .....	A-2
<b>SID .....</b>	<b>A-3</b>
SID 6581 .....	A-3
<b>DIGIPRO .....</b>	<b>A-4</b>
DIGIPRO WAVE "DPRO-WAVE" .....	A-4
DIGIPRO BEAT BOX "DPRO-BBOX" .....	A-4

---

---

DIGIPRO DOUBLEDRAW "DPRO-DDRW" .....	A-5
DIGIPRO ENSEMBLE "DPRO-DENS" .....	A-5
<b>FM+ .....</b>	<b>A-6</b>
FM+STATIC "FM+STAT" .....	A-6
FM+PARALLELL "FM+PAR" .....	A-7
FM+DYNAMIC "FM+DYN" .....	A-7
<b>VO .....</b>	<b>A-8</b>
VO-6 .....	A-8
VO-6 TUTORIAL .....	A-9
<b>GND MACHINES .....</b>	<b>A-10</b>
GROUND "GND" .....	A-10
SINE WAVE "SIN" .....	A-10
NOISE "NOIS" .....	A-10
<b>FX MACHINES .....</b>	<b>A-12</b>
THRU .....	A-12
REVERB .....	A-12
CHORUS .....	A-13
DYNAMIX .....	A-13
DYNAMIX TUTORIAL .....	A-14
RING MODULATOR .....	A-14
PHASER .....	A-14
FLANGER .....	A-14
<b>APPENDIX B: MIDI CONTROL REFERENCE</b>	
MONOMACHINE MIDI SPECIFICATION .....	B-1
NOTE ON & NOTE OFF MESSAGES .....	B-1
CONTROL CHANGE MESSAGES .....	B-2
NRPN MAPPING .....	B-5
OTHER MIDI MESSAGES .....	B-6
<b>APPENDIX C: SYSEX REFERENCE</b>	
<b>INDEX</b>	





---

## INTRODUCTION

Thank you for choosing the Monomachine SFX-6/SFX-60/SFX-60 MKII/SFX-60+ MKII as your companion for music creation. It is a powerful and intuitive tool for creating sounds, melodies and musical compositions of all kinds. We hope you will have a lot of fun while exploring the vast possibilities of the Monomachine. To make the most of the machine, we would like you to carefully read the relevant parts of this manual before operating the instrument.

Two main versions of the Monomachine exist. The keyboard variant SFX-6 and the keyboardless SFX-60/SFX-60 MKII/SFX-60+ MKII modules. To avoid confusion the SFX-60/SFX-60 MKII/SFX-60+ MKII models will from here on be referred to as the Monomachine tabletop versions.

### CONVENTIONS IN THIS MANUAL

In this manual we have used certain conventions for indicating input using knobs and buttons through the user interface. These conventions are listed below.

Keys (buttons) are written in upper case with bold style, and they are enclosed in brackets. For instance, the key “function” on the main panel is written **[FUNCTION]**.

Menu names, certain modes and operations are written in upper case. The SYNTHESIS menu is an example of that.

Setting alternatives are written in bulleted form.

Messages visible on the screen will be written in upper case with quotation marks. Like this, “RECEIVING DUMP”.

Parameter abbreviations as they appear on the screen are written in bold style, for example **PTCH**

Knobs are written in upper case with bold, italic style. For instance, the ***LEVEL*** knob is an example of this.

LED indicators like the record LED are written <RECORD>.

The following symbols are used throughout the manual:



This symbol indicates information that you need to pay attention to.



This symbol indicates a tip that might make it easier interacting with the Monomachine.



This symbol is used to caution you to protect your hearing (once).



---

## THE PHILOSOPHY OF THE MONOMACHINE

Synthesizers are available in many different types and forms. Nevertheless, for most part they follow the norm how a synthesizer of its era is expected to be. Development for musical tools generally comes in the form of new synthesis techniques or an increase in polyphony, memory or other quantitative elements. The advances in the music machine world have brought numerous good inventions for musicians. However, we believe usability is easily lost in the hunt for the highest specifications.

With the Monomachine we have tried creating a synthesizer free from prejudice, and focus on what actually spurs creativity without letting technology stand in your way. We want to inspire you to make sounds and music you haven't even thought of.

We have put all our efforts into exploring, to the fullest extent, the concept we believe is one of the most creative in the history of synthesizers - the monophonic synthesizer with a tightly integrated sequencer. The Monomachine offers ground breaking sound synthesis machines, divided into five Monosynths, together with dedicated track effects. The sound synthesis tracks are controlled with the world's most advanced pattern based sequencer, inspired by the concept found in grid programmed drum machines.

### KEEP IN MIND

The Monomachine is a very multifaceted synthesizer. Depending on how you choose to use it certain aspects of it will be more important to you. We have combined many new creative approaches with what we enjoy most in the tradition of synthesizers.

Try to find your own way of working, whether it being using the song sequencer to build complete songs, building patterns for real-time manipulation using the MULTI TRIG function, or using your favourite sound in POLY mode. This user's manual will guide you through all the functions and give some hints on relevant applications.

### HIGHLIGHTS

- **6 Track Internal Sequencer with sound synthesis**
- **6 Track External MIDI Sequencer**
- **5x Monosynths: SuperWave, SID, DigiPRO, FM+, VO**
- **Dynamically controlled Stereo effects.**
- **6x Tape-style Tempo synced delays**
- **18x Tempo synced LFO's**
- **12 Arpeggiators**
- **Full real-time control**
- **DigiPro user waveforms (MKII units only)**
- **Man-machine potential**

## +DRIVE FEATURES

The Monomachine SFX-60+ MKII comes with the +Drive installed by default. A +Drive allows for thousands of patterns, sounds, songs and waveforms to be stored internally and more or less instantly recalled. All Monomachine models can be upgraded with a +Drive. Read more about the +Drive menus and settings on page 105.

The +Drive adds 128 Snapshots. A Monomachine Snapshot can contain up to 128 patterns, 128 kits, 24 songs and 8 globals. If the Monomachine is a MKII model, each Snapshot is also linked to a Digibank. A Digibank consists of 64 user replaceable waveforms. Digibanks can be dynamically switched within a Snapshot.

When you load a Snapshot it is transferred to the Battery Backed Memory of the Monomachine. From here you can edit the patterns, kits, songs and globals of the Snapshot. In the case of MKII models, the Digibank associated with the Snapshot is transferred to the DSP.

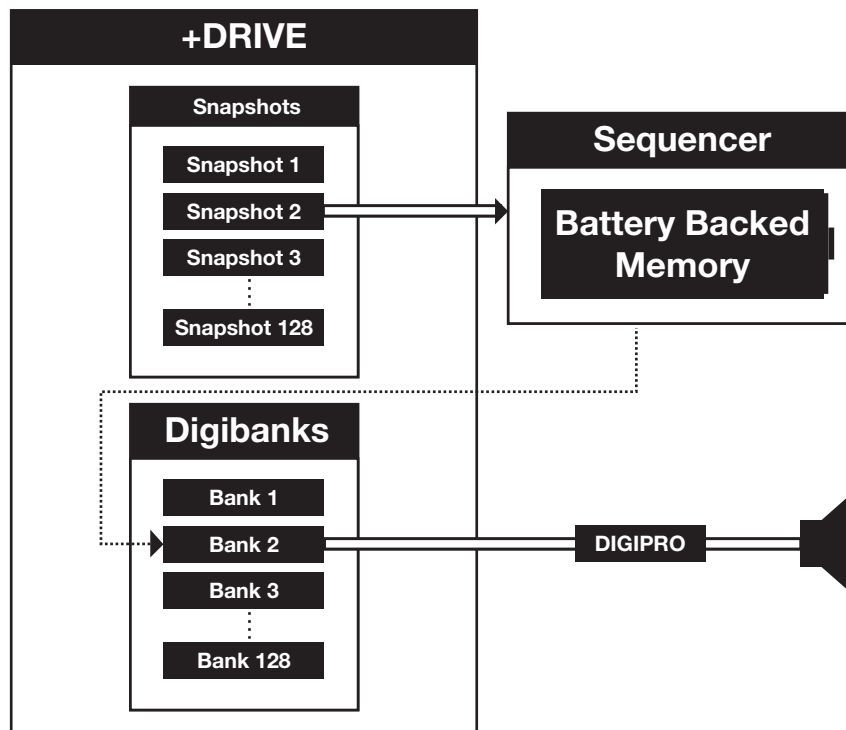

USER INTERFACE AND CONNECTORS

FRONT / MAIN CONTROL PANEL

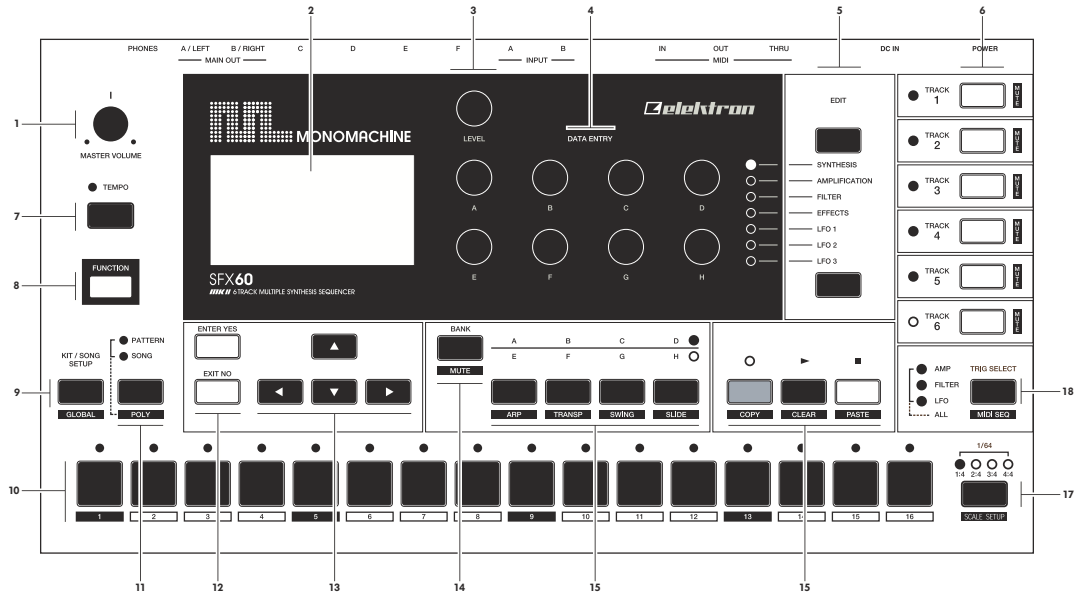

The Monomachine main control panel:

1. Master volume control. Sets the volume for the main output and the headphone jack.
2. The LCD graphical interface display.
3. **LEVEL** knob. Sets the overall volume level of the track in focus.
4. **DATA ENTRY** knobs. Used for tweaking parameters for the machines and effects.



- The **DATA ENTRY** and **LEVEL** knobs allow accelerated editing by pressing the knob while turning it.
- 5. **[DATA PAGE]** selection keys. These keys are used for browsing through the seven DATA pages. The current selection is indicated by the <DATA PAGE> LED's to the left of these keys.

Press both **[DATA PAGE]** keys simultaneously to open the MULTI ENV window.

6. **[TRACK]** keys 1-6. These keys are used for selecting which track is in focus of editing. The secondary function is to mute or activate the track. The <TRACK> LED's are located to the left of the **[TRACK]** keys. These indicate which tracks are active or muted, and also which track is in the editing focus. The LED colours indicate the following: Green = Active, Non-lit = Muted, Red = Active in focus, Yellow = Muted in focus
7. **[TEMPO]** key. Press to bring up the tempo window for adjustment. The current tempo is always indicated by the speed of the flashing of the <TEMPO> LED. While holding **[FUNCTION]** you can use **[TEMPO]** for tapping the tempo.
8. **[FUNCTION]** key. Press and hold it for accessing the secondary function of another key.
9. **[KIT/SONG]** key. Opens the kit menu, or the song menu if in song mode. The secondary function is calling the **[GLOBAL]** menu.

10. **[TRIG]** keys 1 to 16. Main functions of these keys are as keyboard for triggering notes, and for editing notes in GRID RECORDING mode. They are also used for choosing patterns, if pressed while holding one of the **[BANK]** keys. When functioning as a keyboard, the notes are played with velocity 80. Hold **[FUNCTION]** while playing to play with full velocity (127).
11. **[PATTERN/SONG]** key. Switches between pattern and song sequencer mode. The current sequencer mode is indicated by the <PATTERN> and <SONG> LED's. The secondary function is to set the unit in **[POLY]** mode.
12. **[ENTER/YES]** and **[EXIT/NO]** keys. Used for entering and exiting menus and for confirming choices or aborting functions.
13. The **[ARROW]** keys. Used for menu navigation. The **[ARROW]** keys are individually named **[UP]**, **[DOWN]**, **[LEFT]** and **[RIGHT]**.  
In the main interface screen **[UP]** and **[DOWN]** are used for setting the octave for the **[TRIG]** keys.
14. **[BANK GROUP]** key. Used for switching between bank group A to D and E to H. The <BANK GROUP> LED's to the right indicate the current selection. The secondary function is to enter the dedicated **[MUTE MODE]**.
15. **[A/E]**, **[B/F]**, **[C/G]** and **[D/H]** **[BANK]** keys. Hold one of the **[BANK]** keys and then press one of the **[TRIG]** keys to select the pattern (A01-H16) indicated by the label of the **[BANK]** key and the <BANK GROUP> LED's. The secondary functions are to edit the track settings for the arpeggiator and the transpose, swing and slide functions.
16. **[REC]**, **[PLAY]**, **[STOP]** keys. The **[REC]** key is used for toggling GRID RECORDING mode on/off. **[PLAY]** Initiates playback of a pattern or song. Pressing **[PLAY]** a second time pauses playback. Press **[PLAY]** while holding **[REC]** to enter LIVE RECORDING mode. Press **[REC]** while holding **[STOP]** to enter STEP RECORDING mode. **[STOP]** halts the playback of a pattern or song. Press **[STOP]** twice to rewind the song and turn off all sound and reset various things. In GRID RECORDING mode, the <RECORD> LED gives a steady light, in LIVE RECORDING it flashes and in STEP RECORDING mode it double flashes. The secondary functions of these keys are to perform copy, paste and clear commands.
17. **[SCALE]** key. In GRID RECORDING mode: switches the track page focus of the **[TRIG]** keys if the scale length exceed 16. The trig positions are organised in up to four pages with 16 positions in each. The <TRACK PAGE> above the **[SCALE]** key indicate which page is currently being edited or played. The secondary function is calling the SCALE SETUP menu.
18. **[TRIG SELECT]** key. Switches which trig track is programmed from the **[TRIG]** keys. The <TRIG TRACK> LED's to the left indicate the current track selection. The secondary function is to enter or exit the MIDI SEQ mode.

KEYBOARD INTERFACE, SFX-6

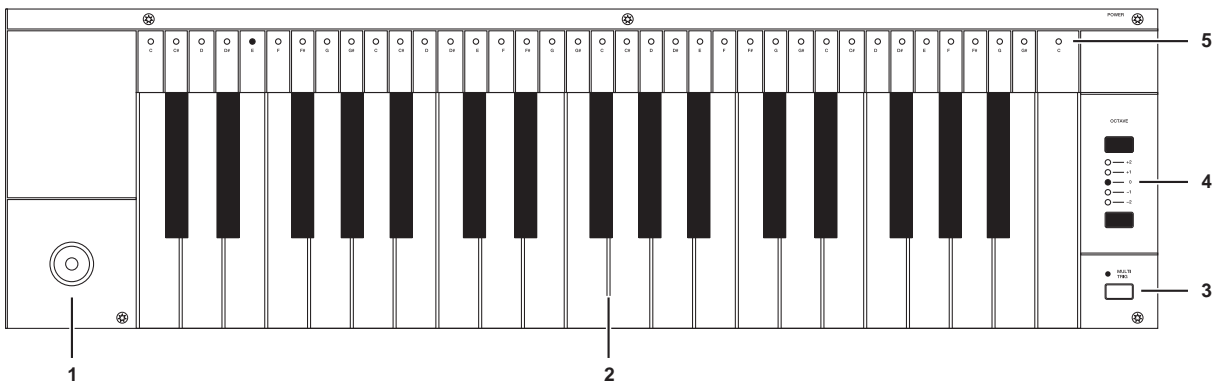

1. Joystick, for real-time expression control. The joystick can individually control parameters for all tracks.
2. Keyboard, for real-time playing and for use in the GRID RECORDING and LIVE RECORDING modes.
3. **[MULTI TRIG]** key, used for toggling the MULTI TRIG mode. The current state of the MULTI TRIG mode is being indicated by the <MULTI TRIG> LED above. The secondary function of this key is to toggle the MULTI MAP mode. MULTI MAP mode is indicated by the <MULTI TRIG> LED flashing. Read more about these modes of operation in the section "MULTI TRIG" on page 41 .
4. **[OCTAVE]** keys. Control which octaves the keyboard is playing, and which notes are represented on the <KEYBOARD> LED's.
5. <KEYBOARD> LED's. Shows the notes being played on the active track, or programmed on a step selected in GRID RECORDING mode.

REAR CONNECTORS

SFX-60

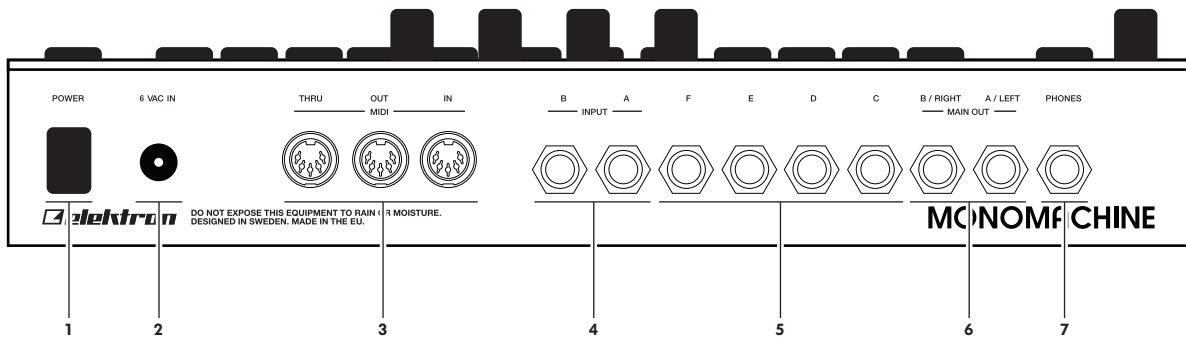

SFX-60 MKII

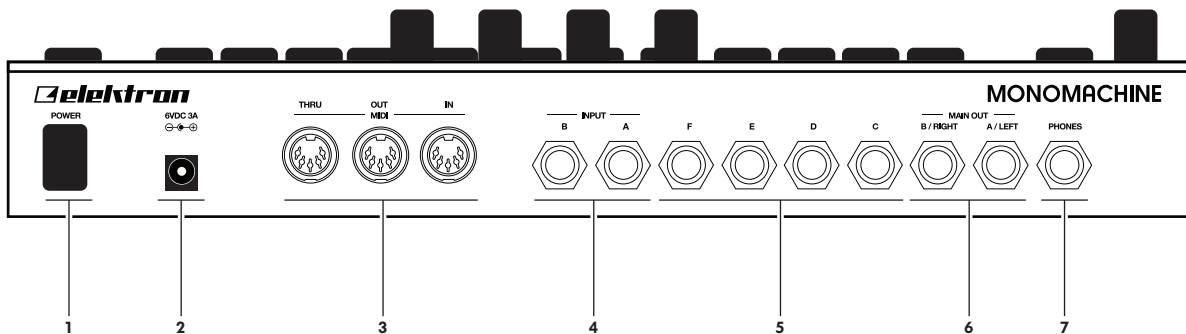

1. Power On/Off switch.
2. Power in.



- **Caution! Use only an Elektron-approved power supply with your Monomachine MKII version. It allows the unit to be used all over the globe without the need of voltage converters. If you need a new power supply the specifications are 6VDC, 3A, 5.5x2.5mm (2.5mm inner diameter) DC power plug (power at center), ungrounded 2 prong inlet (IEC320-C8). Using the wrong type of adapter may result in damage to your unit. Damage caused by the use of incorrect power supply is not covered by warranty. If you are unsure about your power supply, please contact Elektron support.**
- **Note that the MKI models require a different power supply compared to the MKII models. Please see “DIFFERENCES BETWEEN THE MKI AND MKII MODELS” on page 114 for detailed info about the specifications of the power supply that should be used with the MKI models of the Monomachine.**

3. MIDI Thru/Out/In
4. Audio Input B/A
5. Individual Audio Outputs F/E/D/C

6. Main/Individual Audio Outputs B/A
7. Stereo Headphone Outputs (Amplified copy of output AB)

### ADDITIONAL REAR CONNECTORS, SFX-6



1. AC 115/230V 50/60Hz Input with integrated fuse holder and spare fuse storage.



- **Caution! Although the Monomachine SFX-6 can accept both 115 and 230 Volts main current, both the voltage selector and the fuse need to be matched to the voltage. The fuse holder has two sections. The inner is the one currently in use. For 115V operation the fuse should be specified as 250mA, 125V. For 230V operation the fuse should be specified as 125mA, 250V.**
2. Power On/Off switch.
  3. Voltage selector.



- **Caution! If you want to change the voltage for the Monomachine, please take notice of the warning found in the first point of this section.**

### RACK MOUNT KIT

All Monomachine versions, except the SFX-6, can be rack mounted in a standard 19" rack, using the Monomachine/Machinedrum rack mount kit which is ordered separately. When rack mounted, the Monomachine occupies four standard height units plus additional space needed to accommodate for cables plugged into the unit at the back.

### RACK MOUNT KIT ASSEMBLY

Make sure that you use a Philips screwdriver of the right size, and in good condition. Use the included M3x6mm size screws to secure the rack mount consoles on each side of the Monomachine. Make sure that all screws are fastened for secure operation of the unit.

### CONNECTING THE UNIT

Follow the basic guide below to power up your unit for the first time.

1. For SFX-6: Insert the supplied power cord in a grounded wall socket, specified as the voltage selector on the back of your SFX-6.  
For MKI/MKII versions: Connect the supplied power supply unit to a wall socket, and connect the small plug into the rear of the unit.
2. Connect the Main Audio Out A/B from the Monomachine to your mixer or amplifier, and/or connect a pair of stereo headphones to the Headphone Output.
3. If MIDI control is desired, connect the MIDI OUT from the Monomachine to the MIDI IN of the device you wish to send data to. Connect the MIDI IN of the Monomachine to the MIDI OUT of device you wish to receive data from. The MIDI THRU port is "echoing" the data coming in from the MIDI IN port, so it can be used for daisy chaining other MIDI units.



4. Switch all units on.
5. If you do not have any previous experience of the Monomachine we suggest that you follow the “QUICK START” on page 11.

### CARE INSTRUCTIONS

To ensure many years of trouble free operation, please follow the advice below:

- **Never use any aggressive cleaners on the casing or the LCD overlay. Remove dust, dirt and fingerprints with a soft dry cloth. More persistent dirt can be removed with a slightly damp cloth using only water.**
- **Never use sharp objects near the display to avoid scratches or damage. Also avoid applying any pressure to the display itself.**
- **When transporting the Monomachine, try to use the box in which it was originally shipped with the padding supplied, or equivalent packaging.**
- **Make sure that you place the unit on a stable surface before use. If you mount the unit in a rack, be sure to tighten all four screws in the rack mount holes.**
- **The memory used for storing patches and kits is powered by a battery inside the unit. It will hold data for at least 6 years before needing replacement. If the battery needs replacement, the “BATTERY LOW” message will appear in the display. Contact Elektron support or your nearest repair center.**
- **Turn off the machine when not in use.**

## THE LCD USER INTERFACE

The center of the Monomachine editing is the LCD graphical interface display. The interface screen for the SYNTHESIS page is printed below:

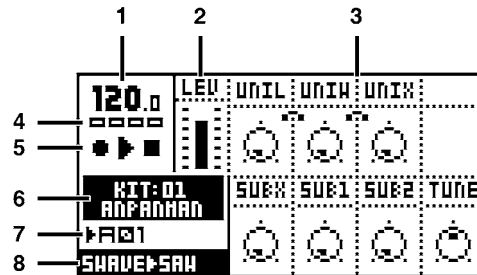

1. The current tempo. This will show “EXT” when synced to external tempo.
2. Level bar showing the selected volume level of the machine on the track in focus.
3. Up to eight parameters. They correspond to the layout of the 8 **DATA ENTRY** knobs. The little dot in the circle indicates the current parameter value. If an knob isn’t represented it means it serves no function at that particular screen. Above the graphical representation of the knobs are up to four characters, the abbreviation for the parameter the knob controls.
4. Four rectangular boxes showing the playback position in the pattern page.
5. The playback/recording status shown by the standard “record”, “play”, “pause” and “stop” symbols; ■, ▶, || and ■.
6. Name and number of the current kit.
7. The index of the current pattern, ranging from A01 to H16.
8. Specification of the Mono-synth and machine of the track in focus.

## LAYER EDIT AND WINDOWS

When a function which puts a window on top of the main interface screen is opened, the function of certain buttons and/or knobs will change. The buttons that are not used or blocked can still be used to control the layer underneath. For example, when you have called the tempo function it will make use of the **LEVEL** knob, but you can still use the **DATA ENTRY** knobs to control the track in focus. When a window has functions mapped to such interface controls, help is provided at the bottom of the window in the form of icons representing these controls. The icons are:

- The arrow buttons
- ⊙ The **LEVEL** knob
- ⊠ The [FUNCTION] key
- The [TRIG] keys
- ⋮ The **DATA ENTRY** knobs



- All windows can be closed using the [EXIT/NO] key.

## QUICK START

This quick start will guide you through some of the basic operations to get you started using the Monomachine. First connect your unit as described in section “CONNECTING THE UNIT”, on page 8.



- The **DATA ENTRY** knobs have accelerated editing when being pressed. By default, the knobs increase/decrease the parameter value in steps of +1/-1. When pressed, the step length is higher, allowing quicker adjustments.

This guide assumes you have a Monomachine SFX-6 or a Monomachine tabletop with a MIDI keyboard connected to it. You need to take care to set the MIDI keyboard to play on the correct MIDI channel. When we refer to play a sound in MULTI TRIG mode, a MIDI keyboard should be sending on the multi trig channel. By default this is set to MIDI channel 7. When playing on a specific track we recommend using the auto track channel which will switch focus depending on which track is selected with the **[TRACK]** keys. By default the auto channel is assigned to MIDI channel 9. Please refer to section “MIDI CHANNELS”, on page 89 for more information on the MIDI channel assignment of the Monomachine.

## SELECTING AND PLAYING A PATTERN

1. Verify that the <PATTERN> LED is lit and the <SONG LED> is not. If this isn't the case, press the **[PATTERN/SONG]**.
2. Check the <BANK GROUP> LED to see if bank group A-D or E-H is active. If needed press **[BANK GROUP]** key to toggle the active bank group. For this demonstration use group A-D.
3. To select pattern A01, press and hold the pattern selection key **[A/E]** and then press the **[TRIG]** key 1. You can see the index of the currently selected pattern in the lower left corner of the display. Each pattern automatically loads the kit it is linked with. The name of the kit is also shown in the display.
4. To listen to the pattern, press the **[PLAY]** key. The pattern starts playing and loops back to the beginning again when it has reached its end. Pressing **[PLAY]** while playing pauses the playback.

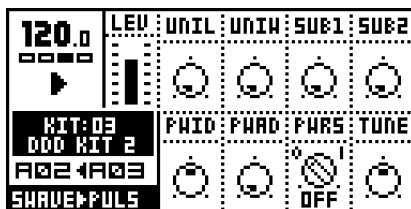

5. To change patterns during playback, simply select a pattern the same way as in step 3. The display will show the selected pattern next to the current one, but with an arrow pointing between them. This indicates that once the current pattern has played to its end, the new selected pattern will start playing.
6. To stop the playback of the pattern, press the **[STOP]** key.

## PLAYING IN MULTI TRIG MODE

1. Select a pattern, ranging from A01-D16. All the Monomachine presets are located in this range. Make sure the sequencer is stopped.
2. Enter MULTI TRIG mode. On SFX-6 press the **[MULTI TRIG]** key and check that the <MULTI TRIG> LED is lit with a steady light. For the Monomachine tabletop versions, select the multi trig channel on your MIDI keyboard.
3. Play some notes!
4. Depending on the trig mode selected in the kit a number of things could happen. Please refer to section “MULTI TRIG”, on page 41 for the full story.

## EXPLORING A PATTERN

1. Select a pattern as previously described.
2. Make sure the sequencer is stopped and that MULTI TRIG mode is switched off on the SFX-6 (<MULTI TRIG> LED not lit) and that the sequencer is not in GRID RECORDING mode (<REC> LED not lit). Use the auto channel if using an external MIDI control keyboard.
3. Select one of the six tracks as the active track by pressing a **[TRACK]** key.
4. For each track the machine loaded is displayed in the lower left corner of the display.
5. Play some notes on each of the tracks, either using the keyboard or the **[TRIG]** keys. Note that it's possible that not all tracks will sound, the track can be an FX that needs input from another track or silenced due to the output assigning, machine selection or track effect settings. If you don't hear anything, try selecting another track.
6. Use the **[DATA PAGE]** keys to navigate between the DATA pages. The <DATA PAGE> LED's will indicate the current selection. Select the SYNTHESIS page.
7. Now, turn any of the **DATA ENTRY** knobs to tweak the machine synthesis parameters on the selected track. You can change any parameters without fear of losing presets or other kits stored, as the changes will not be saved if you don't save the kit. The parameters presented on the SYNTHESIS page are specific to the machine loaded. See Appendix A for information about the parameters and functions of the machines.
8. Use the **[DATA PAGE]** keys to continue to the DATA pages named AMPLIFICATION, FILTER and EFFECTS pages and explore the wide range of sound shaping tools available. You can find information about the track effects on page 26.

## DIFFERENT TYPES OF RECORDING

### OVERVIEW OF GRID RECORDING MODE

You can input notes into a pattern of the sequencer, both while the sequencer is running and when it is stopped. First select the pattern you wish to edit. You might want to select an empty pattern, as all changes are made “live” to the pattern. As factory default, patterns E01-H16 are empty.

1. If you wish you can change the kit assigned to the pattern by, press the **[KIT]** key, then select LOAD in the menu, and select the kit you prefer from the list presented.
2. Press the **[RECORD]** key to enter GRID RECORDING mode. The <RECORD> LED should be firmly lit.

- Choose to active a track using the **[TRACK]** keys. Below is a screen shot of how the SYNTHESIS page could look like after selecting a track.

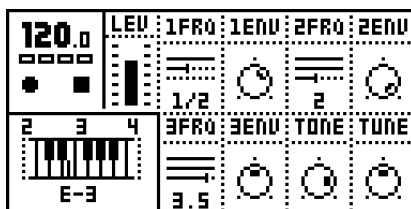

- Press a **[TRIG]** key to add a note trig. A note trig is indicated by a red <TRIG> LED. Pressing the same **[TRIG]** key once more removes the note trig.
- To change the pitch of a note, press and hold the **[TRIG]** key. You will see a mini keyboard pop up in the lower left corner of the screen. Either input the new note on the keyboard or use the **[ARROW]** keys to select the new note. When done release the **[TRIG]** key.
- To enter a note off trig, press a **[TRIG]** key while holding the **[FUNCTION]** key. A Note Off is indicated by a yellow <TRIG> LED. To remove a note off the same **[TRIG]** key must be pressed twice.

### OVERVIEW OF LIVE RECORDING MODE

The LIVE RECORDING mode allows you to record notes in real-time while the pattern is playing.

To enter this mode, press and hold **[RECORD]** and then **[PLAY]**. You can now play notes on the track you want to record, using either the **[TRIG]** or a keyboard. All played notes will be quantised to the closest trig step.

If a note is played on a position where there already was a note programmed the new note will replace the note on that step.

To erase notes in LIVE RECORDING mode hold **[EXIT/NO]** while the notes you want to remove are heard.

The pattern will loop and be ready for further recording until you press the **[STOP]** key.

### PARAMETER LOCKS

A parameter lock is a parameter locked to a certain value for a specific step. Parameter locks can be programmed in GRID RECORDING mode and recorded in LIVE RECORDING mode. Parameter locks are a very important part of creating unique and dynamic patterns.

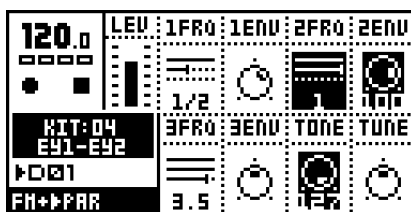

To lock parameters on a specific step in the track in GRID RECORDING mode, hold a **[TRIG]** key and turn or click a **DATA ENTRY** knob. The parameter connected to the knob will be inverted to indicate that it now is has a parameter lock. The corresponding <TRIG> LED will flash rapidly to indicate that a parameter is locked for that step.



In LIVE RECORDING mode, you can lock parameters by turning a knob while recording.

Parameters can be locked for any parameter and track. To lock parameters for a new track, select that track with the **[TRACK]** button and repeat the steps above.

To remove a single lock in GRID RECORDING mode, press and hold the **[TRIG]** key and click the knob connected to the parameter you wish to remove. You will see that the inverted square around the parameter is removed. To remove all parameter locks for a trig, hold the **[TRIG]** key and press **[CLEAR]**. The locks are also cleared when the note is removed.

---

**MONOMACHINE OVERVIEW**

---

The sound generating structure of the Monomachine differs in many ways from what is common for contemporary sound synthesizers and sequencers. The Monomachine offers six tracks of audio synthesis/FX, effects and sequencing. All six tracks can be equipped with a sound generating or sound effecting machine of your choice, Track Effect engine including amplifier envelope, LP/BP/HP filter, synchronised tape-style delay, three LFO's and the most refined step sequencer. Please refer to Figure 1, "Monomachine sound synthesis overview," on page 16 for an overview of the general structure of the Monomachine.

**CHOOSE YOUR WAY OF WORKING**

The Monomachine offers you many ways of working. The six tracks of synthesis can be approached in several ways. Some suggestions how you could organise your work is described below. All the techniques presented will be discussed in detail later in this manual.

**SIX INDIVIDUAL TRACKS**

Each of the six tracks can be programmed with individual sound generating machines and sound and effects settings. Using the Monomachine this way offers you access to six independent tracks of monophonic synthesis. All tracks can also be externally controlled by their assigned MIDI channels if preferred.

**SIX TRACK SEQUENCING**

The six tracks can be controlled by the Monomachine sequencer. In addition to the traditional pitch and note on/off commands, it allows direct control over all sound generating parameters and envelope trigs.

**MIDI SEQUENCING**

Six additional tracks of polyphonic MIDI sequencing for controlling external gear are lined up beside the sequencer for the internal sound generating tracks.

**POLY MODE**

By entering POLY MODE the Monomachine dedicates all six sound generating tracks to offer one track with six-voice polyphony.

**MULTI TRIG MODE**

In MULTI TRIG mode, all six sound generating tracks are controlled simultaneously from a single control source. The sequencer can be a part of the control, and your sequences can be transposed in real-time. This way you can construct the most dynamic and complex monophonic super-sounds imaginable.

**MULTI MAP MODE**

Using the MULTI MAP mode you can lay out your sequences over a keyboard, for live or studio use.

FIGURE 1. Monomachine sound synthesis overview

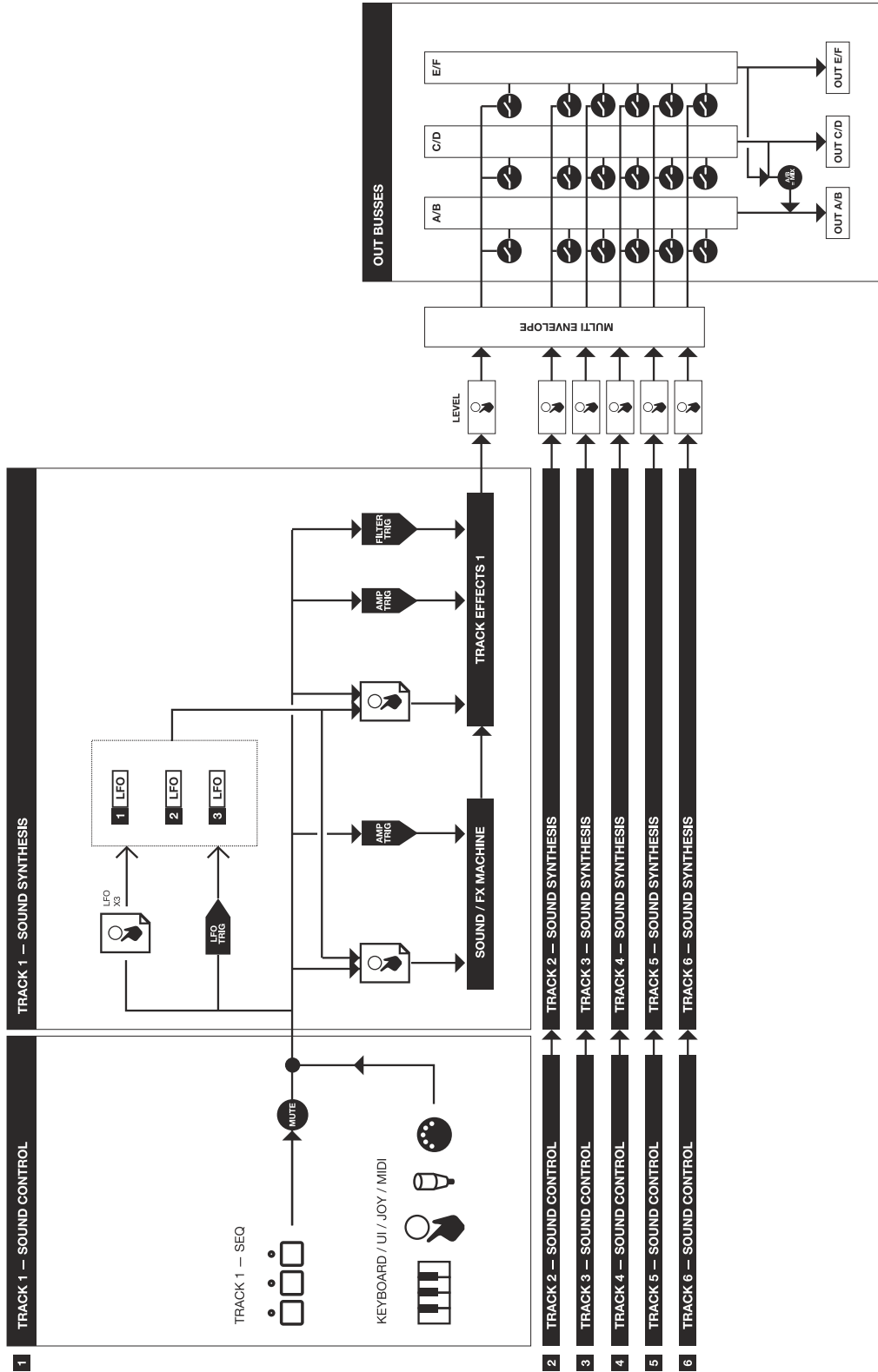



---

### MONOMACHINE SYNTHESIS ARRANGEMENT

The basic sound generating unit in the Monomachine is called a *machine*. Each machine is designed for generating sounds from a specific technique or method, such as analogue style pulse, SID MOS 6581 or dynamic FM. The sound generating machines allow you to get many different starting points with varied sound characteristics.

The machines are grouped in so called *Mono-synths*. It can be viewed as if the machines in a Mono-synth belong to the same family. For example, in the FM+ family there are a total of 3 machines for static, parallel and dynamic FM synthesis. Despite the fact that each machine is based on the family synthesis, each machine can have a unique parameter set. The parameters are selected individually to give the user the best control of the machines. There is a special Mono-synth named FX. The machines in this family do not generate sounds, but offer effects for other tracks.

Description of Mono-synths and their parameters are covered in Appendix A.

Each of the six tracks can have any machine assigned to it. The assignment of machines and their parameter settings are collected in *kits*. Editing the kits is discussed in section "KIT EDITING", on page 22.

All six tracks have their dedicated effect modules. The track effect system consists of the parameters found in the AMPLIFICATION, FILTER and EFFECT pages. Each track effect system delivers hi/lo/band-pass resonant 24-db filter with envelope and individual Q-control, 1-band eq, sample rate reduction, distortion and tempo synchronised tape-style delay. You will also find controls for left/right-pan and portamento speed among the the track effects. The track effects are explained in depth in section "TRACK EFFECTS", on page 26.

Each track offers three powerful Low Frequency Oscillators (LFO's). The three LFO's offer identical functionality, and can be assigned to any machine, track effect or LFO parameter. You will find more information about the LFO's on page 35.

## MONOMACHINE KITS

The Monomachine does not arrange sounds in what is commonly referred to as “patches”. The Monomachine equivalence of a “patch” depends on which way you are using it.

- **If you use the six tracks as individual synthesizers, or in POLY mode, then you could see a kit as carrying six “patches”. The kit would then be the equivalence to what in common synthesizer terms is referred to as a “performance”.**
- **If you use the MULTI TRIG mode, then all six tracks would be triggered from the Multi Trig track. A kit would then be the direct equivalence of what is commonly referred to as a “patch”.**
- **If you use the MULTI TRIG mode and incorporate the sequencer, then your “patch” would incorporate both the kit and the sequencer pattern from which it is linked.**

If you are used to the structure of ordinary synthesizers, the Monomachine way of structuring sounds in patterns and kit might be confusing at first. Hopefully, after some time of use you will appreciate the flexibility and ease of use of the Monomachine implementation.

## THE LINK BETWEEN KITS AND PATTERNS

Each pattern with data is associated with a certain kit, which will be recalled when the pattern is played. This way, you know playing a certain pattern always gives the same result, and that the parameter locks make sense.



- **Be careful to save any changes you have made to your kit that you want to keep. Changing pattern might change kit and then you will lose the old kit settings.**
- **If two patterns use the same kit, the kit will not be reloaded when changing pattern.**

As a reference, Monomachine kits hold the information specified below:

- **The machines selected for each of the 6 tracks**
- **Parameter settings for the 6 machines**
- **Parameter settings for the 6 Track Effects**
- **Parameter settings for the 6x3 LFO's**
- **Parameter settings for the 6 MIDI sequencer tracks**
- **Input and output routings for the 6 tracks.**
- **Trig track and multi trig settings for the 6 tracks.**
- **Parameters for the Multi-envelope.**
- **The kit name**

All kits are battery backed and user definable.

### LOADING A KIT

1. Open the KIT window by pressing the [KIT] key and select the LOAD icon using the [ARROW] keys.

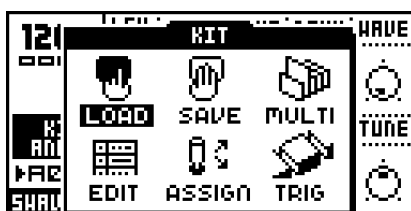

2. Press [ENTER/YES] to open the LOAD KIT window.



3. The window presents a list of the kits stored in memory. Use the [UP] and [DOWN] keys to choose among the 128 kit slots. Press [ENTER/YES] to load the kit of your choice. If you want to exit without loading a kit, press [EXIT/NO].



- Kits that are not associated with any pattern are distinguished by a little star after the kit name.



- The kit currently loaded is indicated by an inverted selection box. The focus, when moved away from the kit currently loaded, is a hollow square box.

### LOADING AN EMPTY KIT

To get a clean kit, open the KIT LOAD window as described above and load a position where no kit was previously saved. The empty positions are indicated with "--" as the kits in the figure below.



After loading an empty kit, you will get six tracks loaded with the GND>SIN machine, and all track effects and other parameters reset to default values.

### SAVING AND NAMING A KIT

1. Open the KIT window.

- Use the arrow keys to move to the “SAVE” icon. Press **[ENTER/YES]** to open the KIT SAVE menu.



- The screen presents a list of the kits stored in memory. Use the **[UP]** and **[DOWN]** keys to choose from the 128 kit slots. Press **[ENTER/YES]** to select the slot where you want to save your kit.
- The next window appearing will allow you to name the kit. Use the **LEVEL** knob or the **[UP]** and **[DOWN]** keys to cycle through the letters. The **[LEFT]** and **[RIGHT]** keys move the cursor backwards and forwards on the line.

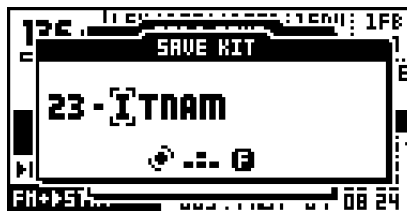

- Pressing the **[FUNCTION]** key gives access to the “high score” selection method, in which you see all characters at the same time. Keep the **[FUNCTION]** key held while navigating using the **[ARROW]** keys. Release the **[FUNCTION]** key, when you have located the letter of your choice.



- When the kit name is complete, press **[ENTER/YES]** to save it.
- If you want to exit without saving the kit, press **[EXIT/NO]**.

### UNDO KIT

There is a special kit in the first position of the kit list named the “UNDO KIT”.



When you have made unsaved changes to a kit and a new one is loaded, the unsaved old kit will be stored in the “UNDO KIT” position. When saving a kit over an occupied position in the kit list, the overwritten kit will also be saved in the “UNDO KIT”.

You can load the “UNDO KIT” to restore your most recent unintentionally lost kit. This can be useful when accidentally changing pattern and the kit is changed so that your unsaved changes are lost. When you have restored your kit using the undo kit, don't forget to save it.

### COPY KIT

When in the KIT SAVE or KIT LOAD menus you can copy and paste kits. For loading a kit, see section “LOADING A KIT”, on page 19. For saving a kit, see section “SAVING AND NAMING A KIT”, on page 19.

1. When you are in either the KIT SAVE or KIT LOAD menus, select the kit you want to copy, hold down the **[FUNCTION]** key and press the **[RECORD]** button. A message saying “COPY KIT” appears.



2. Use the **[UP]** and **[DOWN]** keys to scroll to the slot you want to copy the kit to.
3. To paste the kit into the slot, hold **[FUNCTION]** and press the **[STOP]** button. The message “PASTE KIT” appears.



- If you want to undo the action, press the **[FUNCTION]** + **[STOP]** buttons again. The message saying “UNDO KIT” indicates that the paste operation has been undone.

### CLEAR KIT

You can also clear kits while in the KIT SAVE or KIT LOAD menus.

1. Select the kit you want to clear, hold down the **[FUNCTION]** key and press the **[PLAY]** button. A message saying “CLEAR KIT” appears.





- It is also possible to undo this operation. To undo the action, hold the function [FUNCTION] button and press the [PLAY] button. The message saying “UNDO KIT” indicates that the clear operation has been undone.

## KIT EDITING

You can either create your kit from scratch, or modify an existing one and then save it to a new position. To load an empty kit, see section “LOADING AN EMPTY KIT”, on page 19.

## ASSIGNING A MACHINE TO A TRACK

If you want to create a kit from scratch, follow the instructions below.

1. Open the KIT window and select EDIT KIT using the [ARROW] keys].

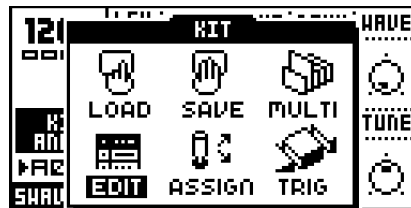

2. Press [ENTER/YES] to enter the EDIT KIT Menu. The EDIT KIT menu is used for changing the machine for the active track, and for specifying audio bus routing. For FX machines you also select the audio input routing for the machine. Read more about FX machines and routing in section “MONOMACHINE ROUTING”, on page 81.

The <TRACK> LED’s indicate which track you are editing, and it is also displayed in the name bar at the top of the window. To change the track in focus, use the [TRACK] keys.



3. Use [LEFT] and [RIGHT] to move between the SYNTH, MACHINE and MIX columns. [LEFT] and [RIGHT] are also used for moving between the OUT BUS positions. You will notice that the name of the active column is inverted. You can use the [UP] and [DOWN] arrows to choose from the available menu choices in the column.

To assing a new machine, first move to the SYNTH column with the [LEFT] and [RIGHT] keys. Select the Mono-synth of your choice by moving the focus using [UP] and [DOWN].

Press **[RIGHT]** once to move the focus to the MACHINE column. Select the machine using **[UP]** and **[DOWN]**.

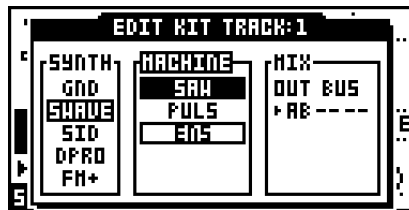

Finally you need to press the **[ENTER/YES]** key to confirm your selection.



- The Mono-synth and the machine currently assigned to the track are indicated by inverted selection boxes. The focus, when moved away from the machine currently loaded, is a hollow square box. When **[ENTER/YES]** is pressed, the current focus will be assigned, thus changing the square hollow focus to the inverted box.

### COPY MACHINE

You can copy one machine and its settings from one track to another. It is also possible to copy the current machine and its settings to another kit.

1. In the EDIT KIT menu, press and hold **[FUNCTION]** and then press **[RECORD]**. A message saying “COPY MACHINE” appears.

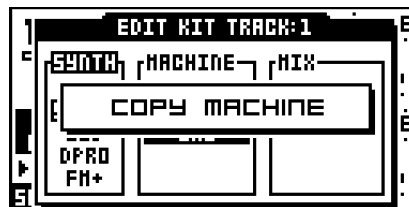

2. The settings are placed in the machine copy buffer. Now you can either change track using the **[TRACK]** keys, or load a new kit and select a target track in there.
3. Once the target track is selected, press and hold **[FUNCTION]** and then press **[STOP]** to paste the machine settings from the copy buffer. A message saying “PASTE MACHINE” appears.

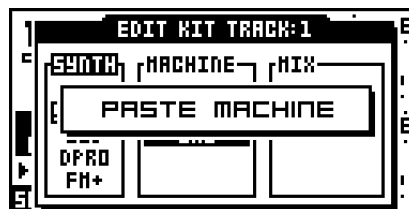

- Any previous machine settings will be overwritten when pasting.



- Once the machine is copied into the copy buffer, it can be pasted many times to several tracks or kits. It will stay in the buffer until it is replaced by a new one.
- See section “SUPER COPY”, on page 54 for a variant of the copy operation.
- The UNDO command is available for this operation. Press the [FUNCTION] + [STOP] once more to undo the paste operation.

### CLEAR MACHINE

It is possible to clear a track, so that it is initialised to the default GND SIN machine.

1. In the EDIT KIT menu, press and hold [FUNCTION] and then [PLAY] to clear the machine. A message saying “CLEAR MACHINE” appears.

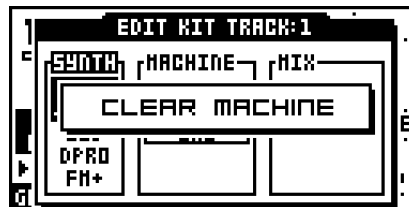

2. A track that you have used the clear machine function on will be displayed like this:

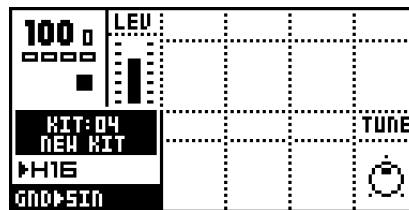

- The clear machine operation can be undone by performing the operation one more time. A message “UNDO MACHINE” will be shown in the display.

### SETTING THE MIX BUS

The Mix bus settings are used for routing the track to the three individual mix busses. It is also used for routing audio to FX machine effects.

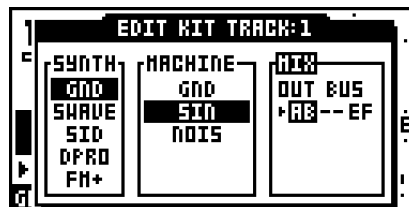

When FX machines are not used on any track, and the master routing is not changed from the default “3xSTEREO”, the OUT BUS selection in the MIX column select to which pair(s) of stereo outputs the track will be directed.

For more information on FX machines and how the Mix bus routing can benefit them, please check section “MONOMACHINE ROUTING”, on page 81.



## PARAMETER EDITING

Each Monomachine track offers up to 56 parameters for the sound generation and effects. They are divided into seven pages with at most eight parameters in each.

The sound generating machines form their sound from one page of up to eight parameters, called the SYNTHESIS parameters. The track effects are composed from 24 parameters, divided into three pages of AMPLIFICATION, FILTER and EFFECTS. There are also three LFO pages, these also bring 24 parameters in total.

First, exit all windows using [EXIT/NO] key. Press the [DATA PAGE] keys until the SYNTHESIS page is chosen. You should see the base window displayed below. The visual parameter names and symbols will depend on the machine assigned.

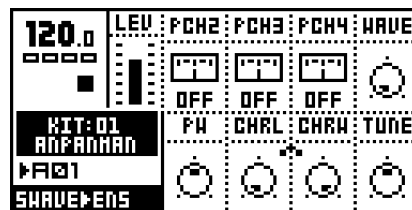

Use the [DATA PAGE] keys to browse through the seven available DATA pages. The <DATA PAGE> LED's will indicate the current focus and the visual parameters will be updated depending on the focus.

Turn the **DATA ENTRY** knobs. The corresponding visual parameter on the LCD screen should be updated accordingly. Press and turn the **DATA ENTRY** knobs for accelerated editing. Just press it to see the numerical value of the parameter.



- **If you want to keep the changes you have done to a kit, don't forget to save it!**

The **TUNE** parameter is available for all synthesis machines. It allows fine pitch tuning of 100 cents up or down.

For information about the various Mono-synths, and their respective machines, please see Appendix A. Here you will find background information about all the Mono-synths, and specifications of the parameters of all machines.

For information about the track effects, please refer to section "TRACK EFFECTS", on page 26. For information about the LFO's, please refer to "LOW FREQUENCY OSCILLATORS" on page 35.

## TRACK EFFECTS

The track effects are independent effects systems, available to the six tracks as extensions to the machine synthesis. This chapter is a reference to all the functions you will find on the AMPLIFICATION, EFFECT and FILTER pages.

The stereo track effects are applied to the sound signal as described in the figure below:

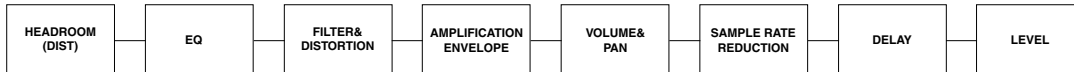

### LEVEL

This parameter is available from all DATA pages. You can always reach it with the dedicated **LEVEL** knob.

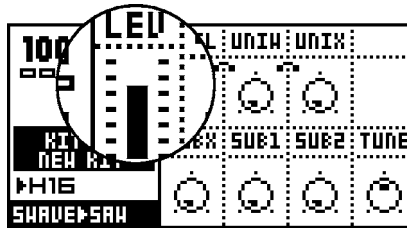

**LEV** controls the overall audio level of the track. It is applied at the end of the audio signal path of the track. The level is designed as a master level control that can not be parameter locked or assigned as a destination for the LFO's. If you want to change the volume of a track, use the track volume parameter on the AMPLIFICATION page. See section "TRACK VOLUME", on page 28 for more information on this parameter.

### AMPLIFICATION PAGE

In the Amplification page you find the controls for the amplifier envelope (AHDR), distortion, volume, pan and portamento.

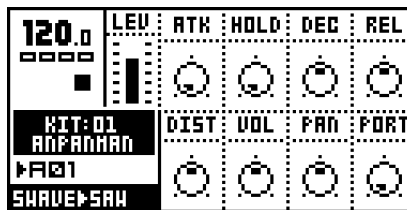

### AMPLIFIER ENVELOPE

The amplifier envelope is triggered every time an AMP-trig is received. This normally happens when a key has been pressed on the keyboard or if the **[TRIG]** keys has been pressed, or if notes have been played from the sequencer or received over MIDI. The

AMP-trig can be controlled individually from the sequencer, see section “TRIG TRACKS”, on page 58 for more information.

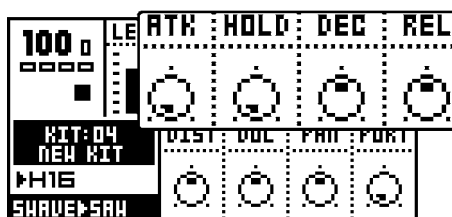

**ATK** (attack). This parameter controls how long time the envelope takes to reach full level.

**HOLD** (hold) specifies the amount of time the signal is held at full level.

**DEC** (decay) dictates the amount of time it takes for the audio signal to completely fade out after the **HOLD** phase has been passed.

**REL** (release). If the key played is released at any time (in MIDI this event is named NOTE OFF), the release phase takes over. The level will then fade by the time specified by the **REL** parameter



- The traditional envelope for synthesizers is in the **ADSR** (attack, decay, sustain, release) form. For the Monomachine sustain has been exchanged for hold. The **HOLD** parameter is very handy when using the sequencer, as it allows you to skip setting **NOTE OFF** events in normal use. If you want to simulate **ADSR** behaviour you can use the ramp and exp shapes of the LFO's, with the **VOL** as destination parameter.

### DISTORTION

Used for adding distortion to a track.

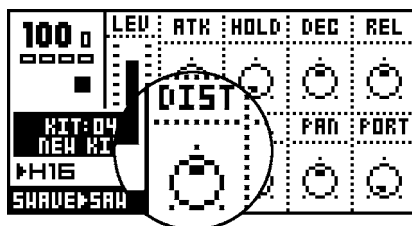

**DIST** (distortion) controls the signal overload distortion. The distortion is applied as an integrated part of the filter, and controls part of the filter characteristics. It also controls the headroom for the filter and the EQ.

If the EQ or filter has been used to enhance the signal, the signal might be distorted even when distortion is set to 0. If you want to remove the overload effect you then need to increase the headroom by decreasing the distortion parameter below zero. You will hear the increase in headroom by the signal level decreasing, and the distortion gradually being removed.



- The headroom is not automatically added when the filter **Q** and **EQ** are used to enhance the signal. This is because increasing the headroom means that the

audio level decline, and if the audio level would decrease when Q is raised, it would feel like a loss of bass and a weaker sound. Always leaving full headroom would result in decreased signal quality, with increased noise. Therefore we allow you to adjust the distortion to allow for the headroom your sound needs.

FIGURE 2. Simplified visualisation of headroom and distortion

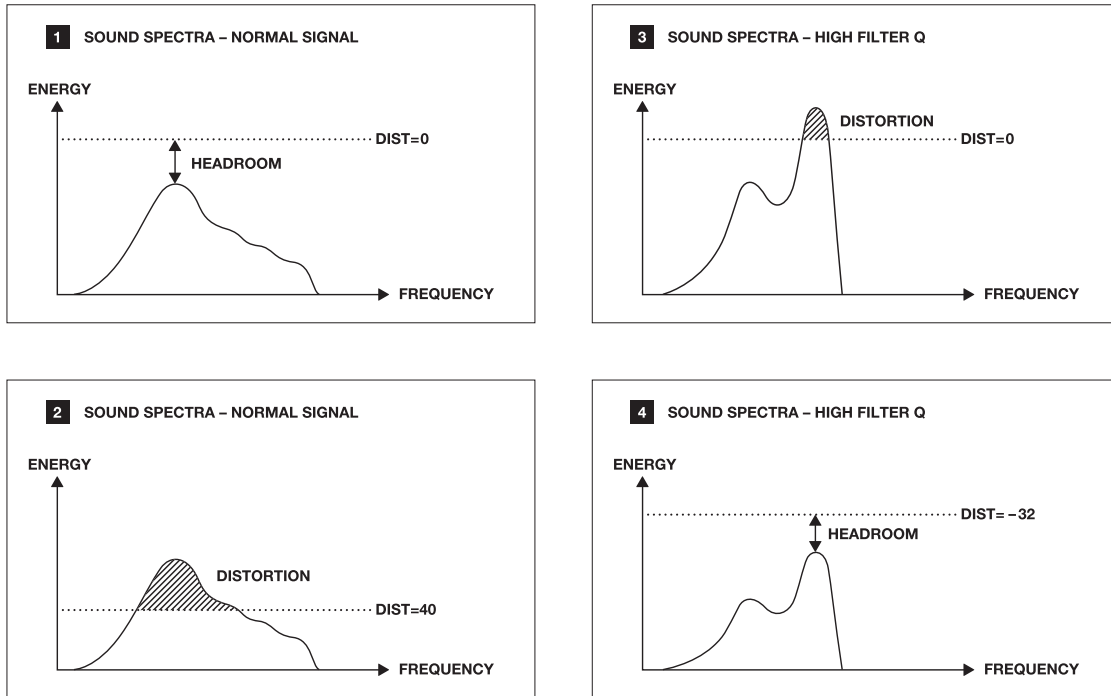

**TRACK VOLUME**

This volume control is separate from the **LEV** overall gain control. Track volume can be parameter locked and controlled by the LFO system.

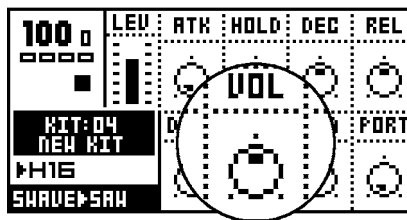

**VOL** (volume) controls the volume of the track.

**PAN**

Here the panning for the stereo output is controlled. It operates in stereo when needed (balance), for example when effecting FX Machines. The default value is center.

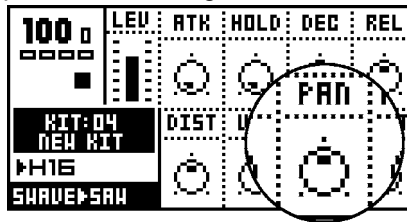

PAN (pan) positions the sound in the stereo field. A value of -64 will pan the sound hard left, a value of + 63 will pan the sound hard right.

**PORTAMENTO**

Portamento controls the sliding between two consecutive notes played. A slow portamento speed gives the effect of a slow pitch-glide to the next note.

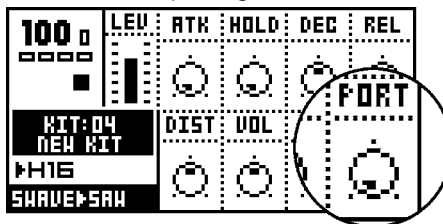

PORT (portamento) specifies the time it takes for the pitch to slide between any two notes.

See also section “TRIG TRACK SETTINGS”, on page 40 for information on the Trig Portamento setting in the KIT>TRIG menu.



- Use the parameter lock feature in the sequencer to control the portamento speed individually for separate notes.
- See also section “TRIG TRACK SETTINGS”, on page 40 for information on the TRIG PORTAMENTO setting in the TRIG menu.

**FILTER PAGE**

In the Filter page you find the controls for the combined resonant 24dB low/band/high-pass filter of the Monomachine, including the filter envelope.

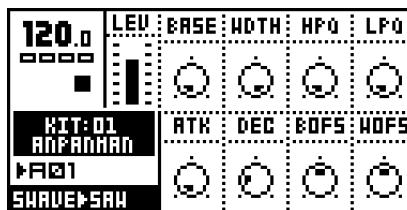

**BASIC FILTER CONTROLS**

The track effect system offers a resonant 24dB low/high/band-pass filter. The parameters are untraditional, giving the user control of both the low and high filter cut-offs, as well as a variable gap band-pass filter.

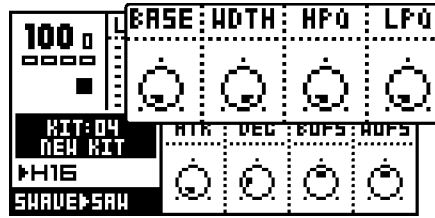

**BASE** (filter base) controls the base filter cut-off frequency. When **WDTH** is set to its maximal value, the **BASE** parameter functions as the cut off parameter of a high-pass filter.

**WDTH** (filter width) controls the filter gap width, that is the distance between the high pass and low pass cut-off frequencies. When the **BASE** is set to its minimum value, the **WDTH** parameter functions as the cut off parameter of a low-pass filter.

**HPQ** (high pass filter Q) controls how much the volume is boosted around the high-pass cut off frequency.

**LPQ** (low pass filter Q) controls how much the volume is boosted around the low-pass cut off frequency.

FIGURE 3.

How the **BASE** and **WDTH** parameters works.

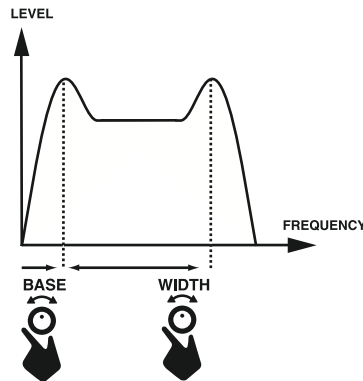
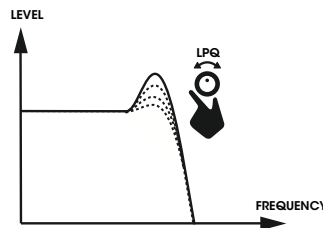

FIGURE 4.

How **LPQ** affects the audio signal.



### FILTER ENVELOPE

The filter envelope is triggered every time a FILTER-trig is received. This normally happens when a key on the keyboard or one of the [TRIG] keys has been pressed, or played from the sequencer or received over MIDI. The FILTER-trig can be controlled individually from the sequencer, see section “TRIG TRACKS”, on page 58 for more information.

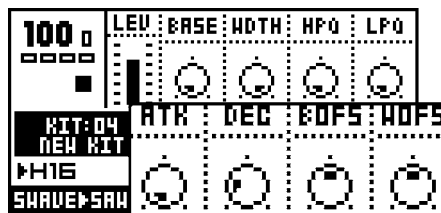

**ATK** (filter envelope attack) controls the attack of the filter envelope

**DEC** (filter envelope decay) controls the decay of the filter envelope

**BOFS** (filter base envelope offset) sets the value that will be added to the filter **BASE** parameter. **BOFS** is controlled by **ATK** and **DEC**.

**WOFS** (filter width envelope offset) sets the value that will be added to the filter **WDTH** parameter. **WOFS** is controlled by **ATK** and **DEC**.



- To make a familiar “synth-bass” low pass filter bump each time the note is triggered, set the **WDTH** to around 64, and turn up the **WOFS** to around 32. Then turn the **LPQ** up until you get the amount of Low Pass filter **Q** you prefer.

### FILTER TRACKING

The filter normally tracks the pitch of the note played. The high pass filter starts cutting two octaves under the base pitch when the **BASE** parameter is set to zero.

Both the **BASE** and the **WDTH** parameters rise one octave for eight steps. This exact locking of the filter to octaves is useful if you want to use high filter **Q** settings to be used for pitch.

The filter tracking can be bypassed for the high pass and the low pass filter individually. You find the controls for doing this under the **KEY** tab in the **KIT>ASSIGN** window, see section “KEY TRACKING”, on page 40 for more information.



- If you want to use the high pass filter **Q** as low frequency “loudness” boost, it is good to turn off the filter tracking parameter **HPF**.

## EFFECTS PAGE

In the EFFECTS page you find the controls for the 1-band EQ, sample rate reduction, and the tempo-synchronised tape-style delay.

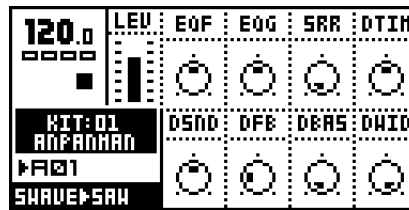

### EQ

Using the 1-band parametric EQ, you can boost or reduce a certain frequency band.

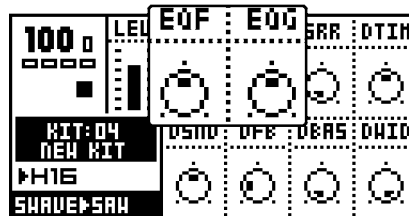

**EQF** (EQ frequency) sets the frequency that will be affected by the **EQG** parameter.

**EQG** (EQ gain) parameter controls how much the EQ will boost (gain) or reduce the signal around the **EQF** frequency. Positive values boost, and negative reduce the signal up to a maximum of 36dB.



- If you notice signal overload when you boost the signal you might need to increase your headroom by decreasing the **DIST** parameter on the Amplification page. Please see section “DISTORTION”, on page 27 for more information.

### SAMPLE RATE REDUCTION

The sample rate reduction effect resamples the signal at a lower sample rate, introducing aliasing effects which gives a digital “lo-fi” effect.

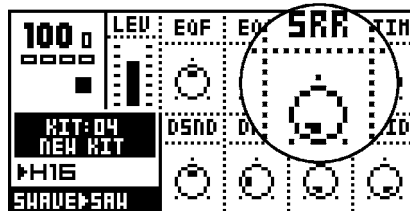

**SRR** (sample rate reduction) controls the amount of sample rate reduction down to a low-est of 2.8kHz.



- The sample rate reduction often gives best effect on signals with some, but not too much, high frequency contents. Sound with too much high frequency information might introduce too much aliasing, resulting in a very disharmonic signal.



**DELAY**

The delay of the Monomachine is a single tap delay with real-time adjustable delay time. Some of its functionality can resemble tape loops and solid state CCD delays. The delay time is always synchronised to the global tempo setting.

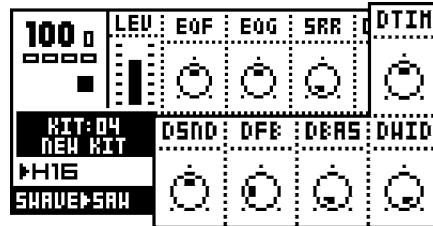

**DSND** (delay send) controls the level of sound that will be sent to the delay loop. To get any effect from the delay you first need to adjust **DSND** to some value other than zero and then generate some sound.

The parameter can be set to positive or negative values. For negative values the stereo image of the signal will be preserved and for positive values it will be switched left-right. The feedback loop will also be switched depending if the **DSND** is set to positive or negative values. This means that you should set negative **DSND** values to get delay with preserved stereo image, and positive values for ping-pong delay.

**DTIM** (delay time) controls the delay time of the delay loop. The actual delay time is relative to the current tempo, and it is measured in 256th notes. For instance, for a one beat delay (four 16th notes) delay time should be set to 64.

When changing the **DTIM** parameter or changing the tempo you will hear the contents in the delay loop speed up or down to adjust to the new tempo set. This behaviour allows the delay time parameter to be changed at any time, without the typical digital artefacts or brief silence sometimes experienced when adjusting delay time of digital delays.

**DFB** (delay feedback) parameter controls how much of the delay output sound will be fed back into the input of the delay. Using the delay feedback you can make delays with several or infinite echoes.

**DBAS** (delay filter base) controls the high pass filtering of the signal from the delay feedback loop.

**DWID** (delay filter width) controls the low pass filtering of the signal from the delay feedback loop, relative the **DBAS** parameter.

FIGURE 5. The function of the delay

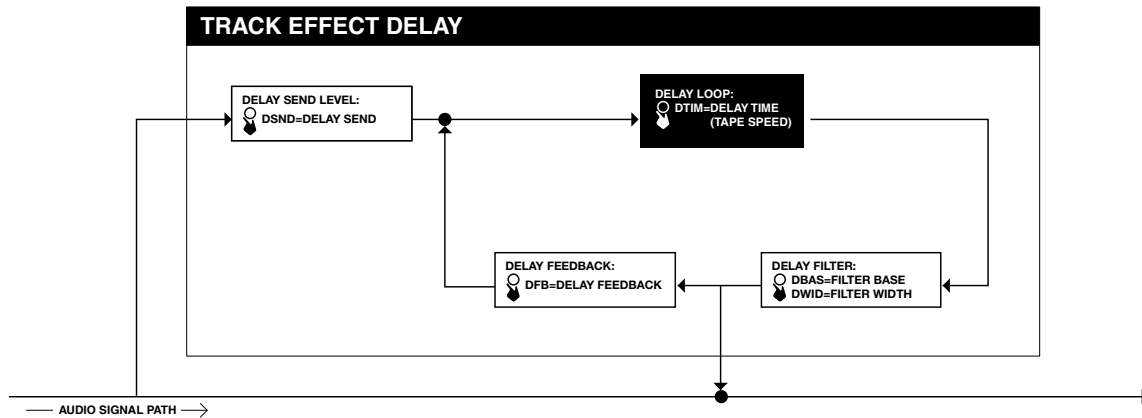

- For using the delay for delay-line style sound sculpturing, try setting DTIM very low together with a DFB value above 32. Then play around with the delay filter settings.
- Try applying an LFO to DTIM for interesting speed-modulating effects!
- Using the DBAS and DWID parameters you can make the delay “echoes” sound sequentially different as the sound goes round the delay loop. Good for dub-inspired delays.



- Watch your tweeters and ears! Feedback values below 64 will cause the sound in the delay loop to diminish over time, but values above 64 will cause the sound to grow until maximum audio level is reached and then distort!

---

## LOW FREQUENCY OSCILLATORS

Each of the 6 tracks in the Monomachine offers 3 interlaced low frequency oscillators (LFO's), which can be used to modulate any track parameter. A typical application of an LFO is to let it sweep a filter cut-off frequency. The 18 interlaced LFO's offer 11 waveforms and 5 trig modes. The LFO's are tied to their specific tracks, and are shared between the internal sequencer and the midi sequencer. The speed of the LFO's is synchronised to the global tempo.

First select a track using the **[TRACK]** keys that you want to alter the LFO's for. Then use the **[DATA PAGE]** keys to locate one of the three LFO pages. All the three LFO's of the track are identical. The <DATA ENTRY> LED's indicate which DATA page is currently selected, and the **DATA ENTRY** knobs control the parameters of the DATA page selected.

### LFO CONTROLS

The three LFO's of each track are identical. They can control any parameter of the track for the internal or the MIDI sequencer, as well as the other LFO's. The LFO control interface is printed below:

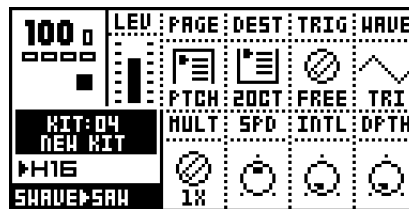

**PAGE** (page) selects which DATA page the LFO targets.

**DEST** (destination) chooses the parameter from the DATA page chosen by the PAGE that is modulated. All seven DATA pages, plus the MIDI sequencer are accessible by the LFO's. There's also a special pitch page, PTCH. If the **DEST** is PTCH 8 destinations are available, offering various ranges to allow for both subtle vibrato and full range frequency sweeps.

**TRIG** (trig mode) is an important parameter for getting the most out of the LFO's. The trig modes are described in the list below, and their function is visualised in combination with the waveforms in Figure 3 on page 32.

- **FREE** = The LFO is running continuously, never restarting or stopping.
- **TRIG** = The waveform is restarted for each LFO-trig, and then runs continuously.
- **HOLD** = The waveform is running free in the background, but the output LFO level is latched for each LFO-trig and held still until the next LFO-trig.
- **ONE** = The waveform is restarted for each LFO-trig, then runs for one cycle and finally stops and holds the last LFO level.
- **HALF** = The waveform is restarted for each LFO-trig, then runs for one half cycle and finally stops and holds the last LFO level.

**WAVE** (waveform) selects the waveform for the LFO from the eleven shapes available. There are 5 basic shapes plus mirrored copies of all but the RND random ("RND") shape. Select the appropriate waveform with the WAVE knob.

**MULT** (multiplier) multiplies the SPD parameter by the set amount of times.

**SPD** (speed) is a linear controller that sets a base speed that is multiplied with the **MULT** parameter, always in relation to the master tempo. The use of both a speed controller and a multiplier allows a very wide range of speeds, but still provides a high degree of control. To get the finest resolution keep the **MULT** parameter set as low as possible.

Increasing **SPD** values gives shorter LFO cycle times. Each increase of the Multiplier halves the LFO cycle time. For LFO speed synchronised to straight beats, try setting **SPD** to 16, 32, 64 or 127. For example setting the **MULT** to 2x and **SPD** to 64 gives a cycle time of sixteen 16th notes (one full page).

**INTL** (interlace) is a function taken straight from the Sidstation. Interlace is the process of alternating the LFO waveform with zero. The speed of the zero-alternating cycles is controlled by the **INTL** parameter. The interlace is switched off when set to zero.

**DPTH** (depth) is the amount of the LFO output level that is applied to the target parameter. Setting **DPTH** to 127 allows for modulating a parameter to and from any extreme value. For example, if the target parameter is set to 64 a **DPTH** setting of 64 is sufficient for modulating the target value to its minimum (0) and maximum (127).

**FIGURE 6.** Monomachine LFO waveform and trig modes

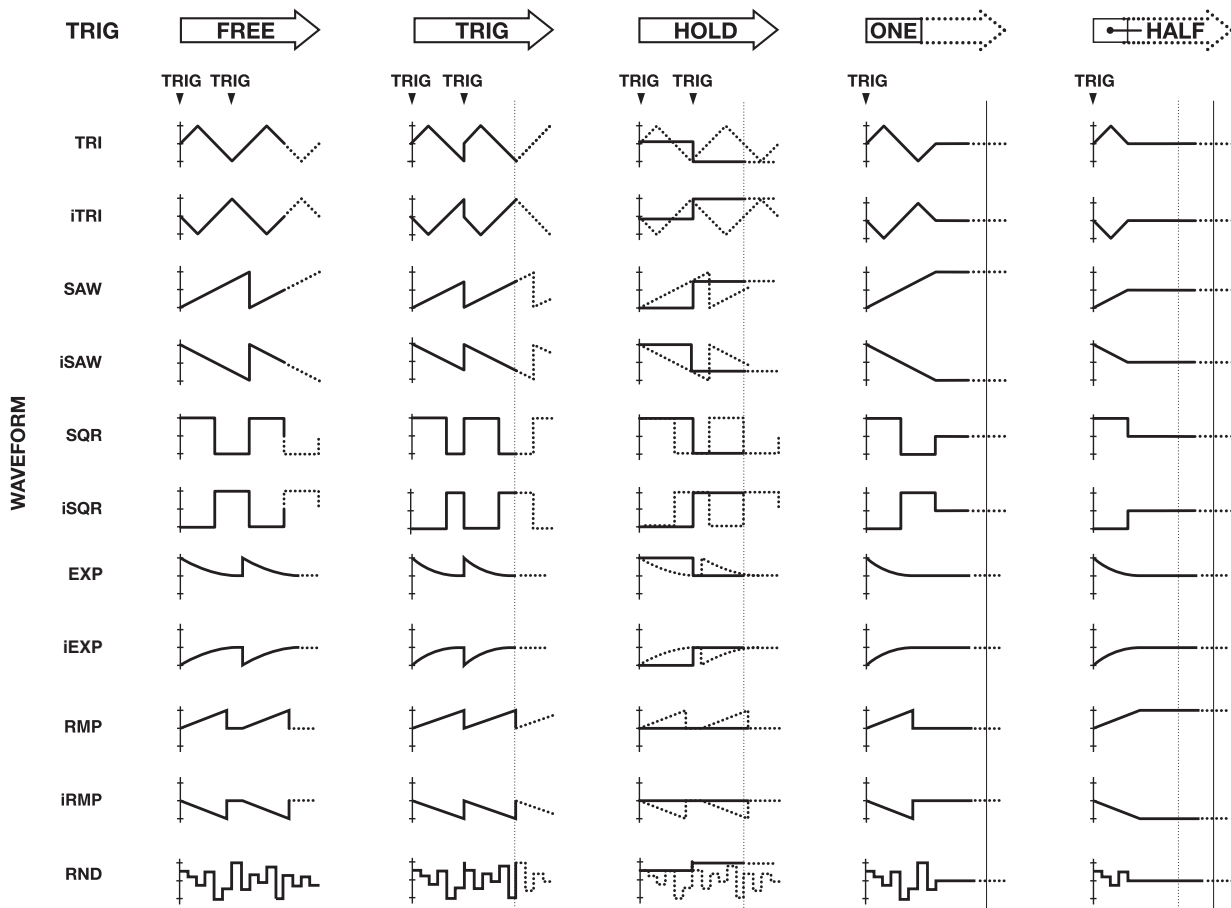



- If you select the same destination for two different LFO tracks their outputs will be added, making advanced layered LFO's possible.
- You can create complex modulations by letting an LFO control a parameter of another one.
- In the Monomachine you can sequence LFO-trig separately from other trigs. Check page 58 for more information on the trig tracks.
- Interlace can be particularly interesting to use with triggered ramps with pitch as destination for creating glittery rain-style effects.
- For arcade game sounds, use a saw LFO with a DPTH of 127, a MULT of 64x and modulate PTCH set to 16OCT.

## ADDITIONAL KIT SETTINGS

This chapter deals with all kit settings not covered in the previous chapters.

### ASSIGN

This menu allows the joystick, note velocity and note position tracking to be assigned to up to two parameters of choice. This can allow for a lot of dynamic depth of the sound with little effort.

1. Press the **[KIT]** key and navigate to the ASSIGN icon using the **[ARROW]** keys.

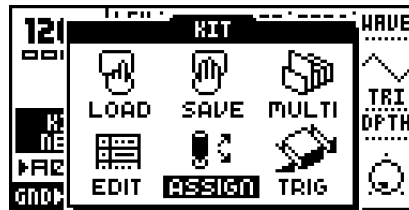

2. Press **[ENTER/YES]** to enter the ASSIGN menu. In the ASSIGN window you will find a minimum of four and a maximum of six tabs. Navigate between the tabs using the **[LEFT]** and **[RIGHT]** keys. Use the **DATA ENTRY** knobs to change settings of the parameters found in the tabs. The settings made here are applied per track. Select which track you want to edit the assign for with the **[TRACK]** keys.

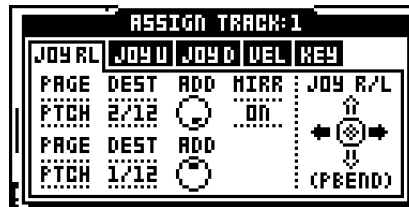

All tabs have two rows with three parameters in each in common.

**PAGE** (page) selects between the seven DATA pages, plus the special pitch destination, just as on the LFO's.

**DEST** (destination) parameter allows to select one of the eight parameters in the DATA page chosen by the **PAGE** parameter.

**ADD** (add/depth) controls how much of the chosen parameter that will affect the destination. **ADD** can be set to positive and negative amounts.



- Setting **ADD** to **+63** or **-64** allows for modulating a parameter to any extreme value. For example, if the target parameter is set to 64 an **ADD** setting of **+32** is sufficient for modulating the target value to its maximum (127). If the target value is set to zero, an **ADD** setting of **+64** is needed for the target to be able to reach its maximum value.

- The copy, clear, paste and undo commands are available in the ASSIGN menu. Press [FUNCTION] + [REC], [PLAY] and [STOP] to conduct these operations. All tabs are copied as a whole, for easy transformation to other tracks or kits.

### JOYSTICK

The first two to four tabs contain the parameters for the joystick.

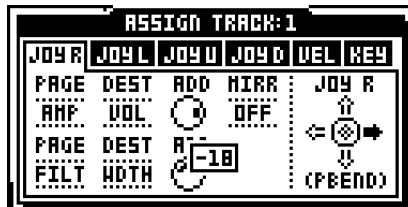

The first tab can control the right or the left, or both right and left directions of the joystick, depending of the value of the

**MIRR** (mirror) dictates how the joystick should react. If **MIRR** is set to OFF, the right and left directions of the joystick have individual parameter pages named "JOY R" and "JOY L". If **MIRR** is set to ON, the right and left directions get the same settings. The parameters of the "JOY RL" page are applied to the right direction, and inverted for the left.

The "JOY U/D" tab has the same function as the "JOY R/L" just described, but controls the assign for the up and down directions of the joystick.



- Information for the Monomachine tabletop versions, and for controlling the SFX-6 externally:  
The Joystick is mapped to Pitch bend for left and right directions, Modulation Wheel (CTRL CHANGE 1) for upward direction and Breath controller (CTRL CHANGE 2) for downward direction.

### VELOCITY

Key velocity is the name for how hard the key is played on the keyboard, or more correctly, the amount of time it takes from the key is pressed until it reaches the base. No parameters additional to the **DEST** and **ADD** are found here.

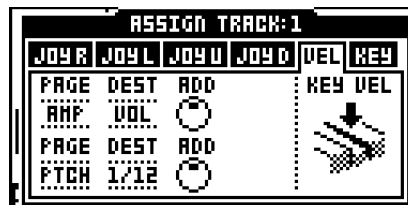

- The key velocity control is mainly for live keyboard playing or sequencing with an external sequencer. The internal sequencer always plays notes with velocity set to 100. Volume and other parameters are instead usually controlled with the parameter locks.

### KEY TRACKING

The Key Tracking is connected to the note index from the last key pressed. For example, if C-1 was pressed, the key tracking value will be low, and if C-8 was pressed it would reach almost its maximum value.

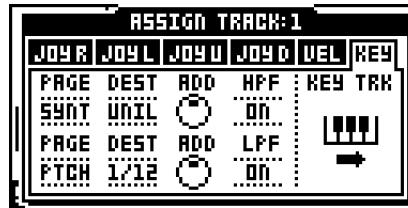

There are two additional parameters on the Key Tracking controlling if the high pass and/or low pass filter should automatically track the pitch. See page 30 for more information on the filter.

**HPF** (High pass filter tracking) disconnects the standard filter tracking of the high pass filter if set to OFF.

**LPF** (Low pass filter tracking) disconnects the standard filter tracking of the low pass filter if set to OFF.

### TRIG TRACK SETTINGS

The trig track settings is a group of parameters which affect the way certain aspects of the sound in the track are triggered.

1. You find the TRIG window in the KIT menu. Press the **[KIT]** key and navigate to the TRIG icon using the **[ARROW]** keys.

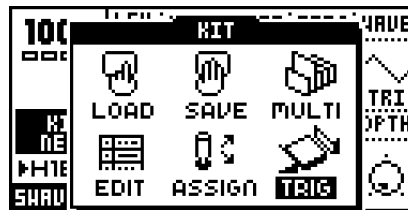

2. Press **[ENTER/YES]** to enter the TRIG TRACK menu. In the TRIG TRACK window you will find five parameters. Navigate between the parameters using the **[UP]** and **[DOWN]** keys. Use the **[LEFT]** and **[RIGHT]** keys to adjust the parameter values.



**TRIG POS** (trig position) allows you to forward the notes being played on the current track to another. For example, if you edit **TRIG POS** for track 1, and set it to point to track 3, then track 3 will also play notes that are sent to track 1. You can chain **TRIG POS**, so that several tracks can be triggered from one.



**PORTAMENTO** (portamento has two options. ALWAYS means the portamento will always be active, gliding between all notes played. ONLY LEGATO makes the portamento active only when playing overlapped so called legato notes.

**LEGATO TRIG MODES** The three parameters at the bottom of the window control which of the AMP, FILTER and LFO trigs will be active for notes played legato.



- For a staccato bass sound it is useful for all trigs to be activated, so the sound will sound the same, even if two notes are played overlapped by mistake. But for a lead sound it might be better to not initiate any trigs for notes played legato.

## MULTI TRIG

The Multi Trig is a link between the synthesis and the sequencer of the Monomachine. Using the keyboard MULTI TRIG mode on the SFX-6, or the Multi Trig MIDI channel (see "MULTI TRIG" on page 90 for more information) you can make advanced monophonic arrangements. All tracks can unite their efforts in creating one dynamic sound, and the sequencer can be part of the arrangement.

1. Press the **[KIT]** key and navigate to the MULTI trig icon using the **[ARROW]** keys.

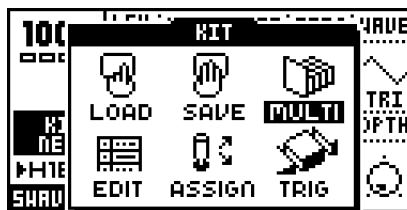

2. Press **[ENTER/YES]** to enter the MULTI TRIG window. Navigate between the available selections using the **[UP]** and **[DOWN]** keys.

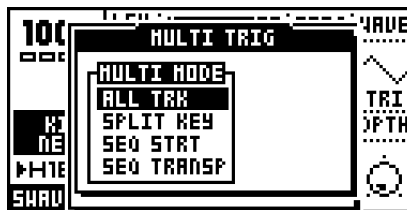

In the MULTI TRIG window you will find one main tab named "MULTI MODE" with four options. To the right there is room for an additional context tab with extra settings for some selections of the first tab. Navigate between the tabs, and inside the context tab (when available) using the **[LEFT]** and **[RIGHT]** keys. Use the **[UP]** and **[DOWN]** keys to adjust the parameter values. Selections in the MULTI MODE tab need to be confirmed with the **[ENTER/YES]** key, whereas the selections in the context tab are effecting immediately.

**ALL TRK** (all track) makes the multi trig channel control all six tracks at once.

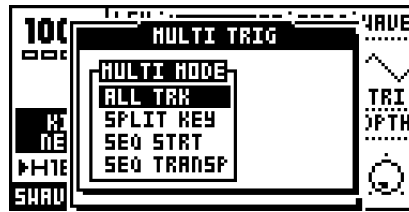

Note events received on the multi trig channel will be distributed to all six tracks for parallel mono operation. The joystick controllers, velocity and key tracking will control all tracks simultaneously, as assigned in the Assign window (see page 38). The Multi Env is applied to the All Track MULTI TRIG mode (see page 43). There is no context tab for the All Track selection.

**SPLIT KEY** (split mode) allows you to split the keyboard in two zones, each controlling part of the tracks.

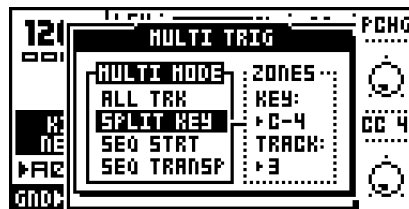

There is an additional tab for the split mode, called ZONES. From the ZONES tab you control which tracks will be devoted to the upper and the lower part of the keyboard, and where the split point is located on the keyboard.

The **TRACK** parameter controls which will be the first track to be controlled by the upper part of the keyboard. All tracks above this one will be controlled by the upper part and the rest by the lower.

The **KEY** parameter controls which key is the first to control the upper part of the tracks. All keys from this one will be directed to control the upper section of the tracks.

For example the settings **KEY: C-4** and **TRACK: 3** plays tracks 3 to 6 from C-4 and up and tracks 1 to 2 below C-4.

**SEQ START** (sequencer start) makes the sequence restart for each note played. The

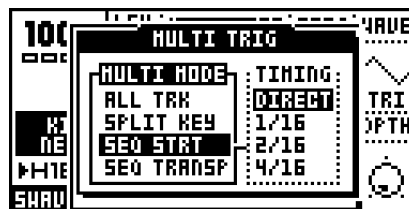

sequence will be transposed based on which note is played. The original pitch will be invoked on C-4. The multi envelope is triggered when notes are played (see page 43).

**SEQ TRNSP** (sequencer transpose) makes a sequence start and transposes the sequence for the first note received on the multi trig channel.

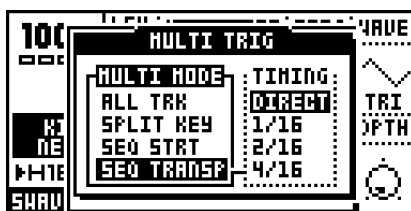

Subsequent notes will only transpose the sequence and trig the multi envelope, so that the sequence loop is never broken.

The action of the **SEQ START** and **SEQ TRNSP** modes can be delayed to an even bar of the loop. This is controlled by the context menu named **TIMING**. If you want to stay in the beat, set the **TIMING** parameter to what you prefer. A setting of 16/16 delays the action until a full page of 16 trigs is played (four beats) in normal tempo mode.



- All arpeggiators of the tracks retain their function in the All Track MULTI TRIG mode. Interesting results can be yield with different arpeggiator settings and speeds for the tracks that then are activated in parallel from the Multi Trig channel.

## MULTI ENV

The multi envelope is an additional envelope applied to all the tracks in the MULTI TRIG modes excluding the SPLIT mode. You reach it by pressing both the **[DATA PAGE]** keys simultaneously.

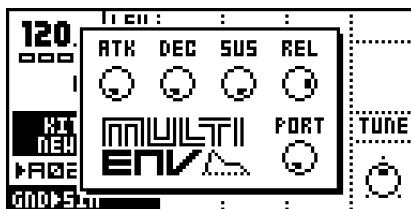

The multi envelope is a standard ADSR envelope that is applied on top of the track envelopes, allowing all the tracks to be treated as one massive monophonic track. Note that you will only hear the effects of the multi envelope when sound are played from the multi trig channel, and not from the SPLIT mode.

**ATK** (attack) dictates the amount of time it take for the audio to rise to full volume after pressing a key.

**DEC** (decay) sets the time it takes for the sound, after the attack phase, to reach the sustain level.

**SUS** (sustain) is the signal level during the time a key is being held.

**REL** (release) sets the time it takes for the signal to decay to zero, once the key has been released.(127 means infinite time to decay)

**PORT** (portamento) sets the amount time it will take the for pitch of the sequence to slide between two different notes.



- **Sound played on the individual tracks while the multi trig is active will be under the influence of the multi envelope, so the sound level might be lower than usual.**



- **If you prefer to let the effect of the Multi Env be inaudible, apply settings of ATK 0, DEC 127, SUS 127 and REL 127.**

## THE PATTERN SEQUENCER

The pattern step sequencer is a central part of the Monomachine sound. It is designed to be an inspirational tool for pattern based music, or a component in the creation of dynamic multi-track monophonic sounds.

The sequencer is designed both for live and studio use. The patterns can either be triggered individually from the user interface or by MIDI commands or they can be linked together with pattern chaining or in song mode.

### BASIC PATTERN OPERATION

The sequencer has several modes of operation, in this chapter we will start by looking at how you select and record patterns. Please prepare by following the instructions below.

1. First make sure that the <PATTERN> LED is lit and the <SONG> LED is unlit. If necessary toggle it by pressing the **[PATTERN/SONG]** key.
2. Check that the <MULTI TRIG> LED is unlit so that you are not in MULTI TRIG mode. If necessary, toggle it by pressing the **[MULTI TRIG]** key. (SFX-6 only)
3. For external control we recommend using the MIDI auto track channel (see "AUTO TRACK CH" on page 90). On the tabletop versions you can use an external MIDI keyboard on this channel when we refer to the keyboard.

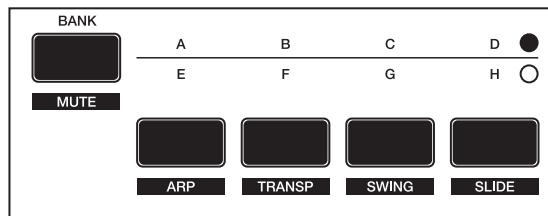

### PATTERN SELECTION

The Monomachine offers 8 banks with 16 patterns in each. The banks are named by the index A,B,C,D,E,F,G,H. The **[BANK GROUP]** key selects between pattern bank groups A to D and E to H. The <BANK GROUP> LED's indicate the current bank group selection.

1. To select a pattern, press and hold the bank key while pressing a **[TRIG]** key. For selecting pattern A05, first make sure the bank LED's indicate that bank group A to D are selected, then press and hold key **[A/E]** while pressing the fifth **[TRIG]** key.
2. While the **[BANK]** keys are pressed you can tell which patterns are used by the 16 <TRIG> LED's. LED's that are red indicate that the corresponding pattern contains data.

If pattern selection is done while the sequencer is playing, the selected pattern will not be active until the current pattern has played to its end. You will see the index of the pattern to be played next blinking to the right of the current pattern..

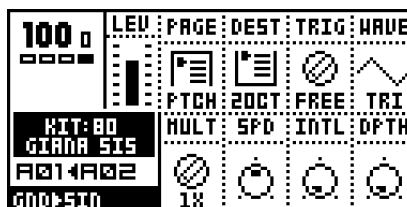

### PATTERN CHAINING

You can use pattern chaining to cue up patterns to be played after one another in a loop, like a simple live sequencer for patterns. In pattern mode, hold a **[BANK]** button and then press the **[TRIG]** key for the pattern you want to be first in the chain. As long as you keep the first **[TRIG]** key down, subsequent **[TRIG]** keys pressed will add patterns to the end of the chain. It is only possible to chain patterns from one bank, and each pattern may only be chained once.

Chaining is indicated by a double arrow between the current and the next pattern.

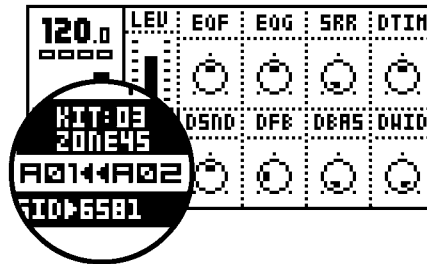

**[STOP]** will reset the pattern chain to the beginning. Pressing **[STOP]** twice will exit the pattern chaining and return to normal operation. Selecting a new pattern exits pattern chaining as well.

### SCALE SETUP

By default the length of a pattern is 4/4 bars, built from 16 steps. We refer to these 16 steps as one *page*. A pattern can be extended to up to 64 steps, which uses a maximum of four pages. All tracks share the same scale length, and are always played in sync.

In GRID RECORDING The **[SCALE]** key is used to cycle between the active pages, and the <TRACK PAGE> LED's indicate which one is currently being edited. When not in GRID RECORDING mode the LED's for the available pages for the track are lit with a steady light. The LED for the page currently playing is flashing.

Press the **[SCALE SETUP]** key while holding **[FUNCTION]** to open the SCALE SETUP window. From here you can set the scale length and playback speed of the pattern currently selected.

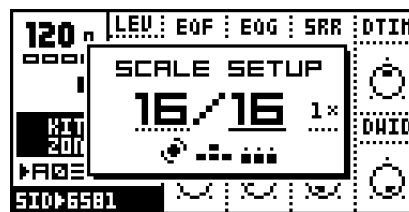

There are three parameters available in the SCALE SETUP window. The underlined focus is moved with the **[LEFT]** and **[RIGHT]** keys.

1. The first parameter sets the total number of steps of the pattern. Use **[UP]** and **[DOWN]** to increase/decrease the number of steps. The **LEVEL** knob is also controlling this parameter, and the **[TRIG]** keys can be used as well to set the end step.
2. The second parameter sets the scale length in divisions of 16 (one full page). If the scale length is higher than 16 the **[SCALE]** key need to be used in GRID RECORDING mode to toggle the focus of the **[TRIG]** keys between the pages.

3. The third parameter is the tempo multiplier. There are four possible settings, “1X”, “2X”, “3/4X” and “3/2X”. 2X allows a pattern to be played back at twice the global tempo. 3/4X allows a pattern to be played back at three quarters of the global tempo. 3/2X will play back a pattern twice as fast as the 3/4X setting. Double speed is useful for increasing the step resolution to 32th notes. Three quarter-speed is useful when the Monomachine is playing alongside other instruments set to the same BPM and you want the Monomachine to play triplets.



- Even though you set a pattern to have a certain length using scale setup, you can change this row by row in the song editor. See section “THE SONG MODE”, on page 73 for more information.
- The [SCALE] key offers a quick way to cycle the scale length in steps of 16.
- When changing the scale length so more pages come in use, lower pages will automatically be copied to higher, but only if nothing so far has been programmed on the pages added. Pages can also be manually copied, see section “TRACK PAGE COPY”, on page 51.
- The default scale length is 16 which gives the time signature 4/4. Setting the scale length to 32 gives the double length of the pattern with 4/4 signature.

## COMPOSING A PATTERN

This chapter will take you through the details how to create a pattern in GRID RECORDING, LIVE RECORDING and STEP RECORDING mode.

### RECORDING PREPARATIONS

Follow the steps below before continuing with any pattern composing.

1. Close all windows that might be open using the [EXIT/NO] key.
2. For SFX-6: Check that the <MULTI TRIG> LED is unlit. Press the [MULTI TRIG] key to switch it off if needed.
3. Check that one and only one of the <DATA ENTRY> LED's are lit. If the four top LED's are lit you need to exit the MIDI SEQ mode by pressing [TRIG SELECT] while holding [FUNCTION].
4. Select a pattern as described in section “PATTERN SELECTION”, on page 45. We recommend starting with an empty pattern. All patterns in banks E-H are empty as factory default.
5. Select a kit for the pattern as described in section “LOADING A KIT”, on page 19.
6. Select the track you wish to edit using the [TRACK] keys. Check that the track makes sound by triggering it using either the *Keyboard* or the [TRIG] keys.
7. Verify that all the <TRIG TRACK> LED's are lit. Press the [TRIG SELECT] key to cycle until all <TRIG TRACK> LED's are lit if needed.

### GRID RECORDING

Grid recording is a method of percussion composing that first was used in vintage drum machines. In the Monomachine it has been adapted and extended to fit intuitive pattern based arrangements of melodies and rhythms. In the default GRID RECORDING state, the 16 [TRIG] keys represent 1 page of 16th notes.

1. Perform the recording preparations as described in the previous section.

2. Enter GRID RECORDING mode by pressing the **[RECORD]** key. The <RECORD> LED above the key should now be firmly lit.
3. You can press **[PLAY]** if you prefer to listen to the pattern playing while composing. It will loop over and over, until you press **[STOP]** to stop the playback or **[PLAY]** to pause it.
4. Press a **[TRIG]** key to set a note trig for the corresponding step. The <TRIG> LED's indicate which steps contain note trigs. You will see that the LED above the **[TRIG]** key lights up with a red light as you press it. You can remove a note trig by pressing the corresponding **[TRIG]** key one more time. The LED should now be switched off.

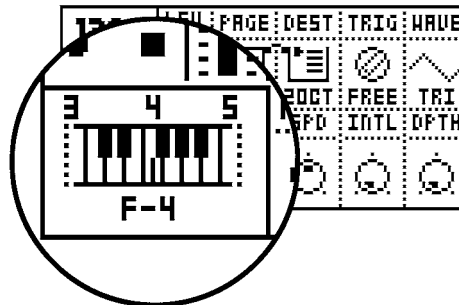

5. While holding a **[TRIG]** key you can see a mini-keyboard appearing after a short delay. It is located in the lower left corner of the LCD interface. This mini-keyboard indicates the pitch of the note, both by a marker on the mini-keyboard and the note printed below. The <KEYBOARD> LED's of the SFX-6 also indicate the pitch programmed.
6. There are two methods for adjusting the pitch of a trig. You can either press a key on the keyboard while holding the **[TRIG]** key to set the pitch indicated by the keyboard key. You can also use the **[ARROW]** keys to adjust the pitch programmed while holding the **[TRIG]** key. Holding **[FUNCTION]** while pressing the **[RIGHT]** or **[LEFT]** key adjusts the pitch one full octave up or down.
7. You can set NOTE OFF trigs by pressing the **[TRIG]** key while holding **[FUNCTION]**. NOTE OFF trigs are events that tell that the key is lift up, starting the *Release phase* of the Amplitude Envelope (see page 26). NOTE OFF are indicated with yellow <TRIG> LED's.

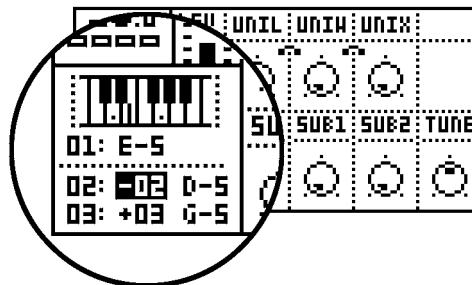

8. Chords can also be programmed. These can be used for POLY mode (see section "POLY MODE", on page 69) and triggering the arpeggiator (see section "THE ARPEGGIATOR", on page 61). If not in POLY mode and if the arpeggiator is not activated, only the base pitch will sound. You can program chords with the keyboard by pressing more keys while holding the first base pitch key. The mini-keyboard shows chord-notes as dots. A scroll list will appear below the mini-keyboard and the base pitch. This list can also be edited using the **[ARROW]** keys. Press **[ENTER/YES]** to enter the list if no chord key is yet entered.





- In the Monomachine, you work directly in the pattern memory. There is no need to save patterns. If you wish to keep the pattern intact you will have to copy it to another pattern before you begin editing it. See section “PATTERN COPY”, on page 53 for more information on copying patterns.



- In GRID RECORDING mode, pressing keys [LEFT] and [RIGHT] while holding [FUNCTION] rotates the trigs and locks of the track one step.
- You can avoid general need of NOTE OFF trigs by making good use of the HOLD parameter (see section “AMPLIFIER ENVELOPE”, on page 26).
- Depending on the scale setup, you might have a longer pattern than what is possible to edit with the 16 LED's and [TRIG] keys. In that case, you need to use the [SCALE] key to change between the pages. See section “SCALE SETUP”, on page 46 for more information.
- The copy, clear, paste and undo functions operate on a specific track when in GRID RECORDING mode. See section “TRACK COPY” on page 52.
- The copy, clear, paste and undo functions operate on the full pattern when not in GRID RECORDING mode. See section “PATTERN COPY” on page 53.

### LIVE RECORDING

The second method of recording notes in the sequencer is by recording them live while playing. You can record both from the keyboard and the [TRIG] keys.

1. Begin with following the instruction in section “RECORDING PREPARATIONS”, on page 47.
2. To start recording in LIVE RECORDING mode, hold [RECORD] while pressing [PLAY]. This starts the sequencer recording and the record LED will start flashing.
3. You can now play notes on the keyboard or the [TRIG] keys, and they will be quantised and recorded to the closest trig step in the pattern. If a note is played on a step where there already was a note programmed the new note will replace the old note.
4. Chords can also be recorded in the sequencer. They will only make effect when in POLY mode (see section “POLY MODE”, on page 69) or when the arpeggiator (see section “THE ARPEGGIATOR”, on page 61) is active.
5. To erase notes on LIVE RECORDING mode hold [EXIT/NO] when the notes you want to remove are played.
6. The pattern will loop and be ready for further recording until you press the [STOP] key.



- All live recorded data will be quantised to the current scale resolution (16th or 32th notes).



- If you want to edit the recorded notes, you can use grid recording as described in section “GRID RECORDING”, on page 47.

### STEP RECORDING

The third method of recording notes differs a bit from the other two methods as data is input on a step by step basis. You can input notes from the keyboard and the **[TRIG]** keys

1. Begin with following the instruction in section “RECORDING PREPARATIONS”, on page 47.
2. To enter STEP RECORDING mode, press **[REC]** and **[STOP]** at the same time.
3. The pattern will start on the first step of the sequencer. From here the active position will automatically advance one step forward when a note or chord is programmed.
4. You can use the **[LEFT]** and **[RIGHT]** keys to move the editing focus of the pattern. Press the **[EXIT/NO]** key to program a NOTE OFF, press **[ENTER/YES]** to clear a note.



- Use the step recording method as an experimental way of creating patterns. Interesting results can be had!

### NOTE COPY

It is possible to copy a note trig, complete with all parameter lock settings, and paste it to a new location in the track.

1. Make sure you are in GRID RECORDING mode, indicated by the <RECORD> LED giving off a steady light.
2. Press and hold the note trig you want to copy and press the **[RECORD]** key. A message “COPY NOTE” will appear.

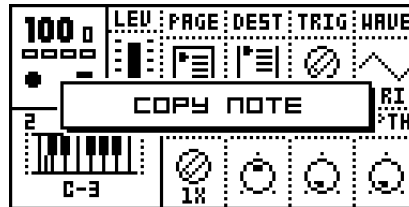

3. Hold the **[TRIG]** key corresponding to the location you want to paste the note to and press the **[STOP]** key to complete the paste operation. A message “PASTE NOTE” will be shown.

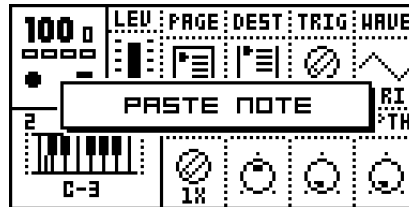

### CLEAR NOTE PARAMETER LOCKS

Instead of removing the parameter locks from a note you can also use the clear note locks command.

1. Make sure you are in GRID RECORDING mode. The <RECORD> LED should be lit.

2. Hold and press the **[TRIG]** key whose content you want to clear. Then press **[PLAY]** to clear the note. The message "CLEAR NOTE LOCKS" will appear.



The clear note lock operation can be undone by performing the clear note operation one more time. The message "UNDO NOTE LOCKS" will be shown in the display.

### TRACK PAGE COPY

In GRID RECORDING mode you can copy one page of trig data and paste it to another page.

1. Make sure you are in GRID RECORDING mode, indicated by the <RECORD> LED giving off a steady light. Select the source track using the **[TRACK]** keys.
2. Select which page you want to copy by pressing the **[SCALE SETUP]** key.
3. When you have chosen the page you want to copy, hold the **[SCALE SETUP]** key and press **[REC]**. The message "COPY PAGE" page will appear.

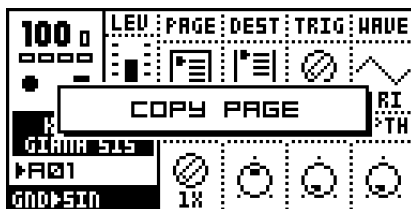

4. Select the pattern page you want to paste the copied page into by pressing the **[SCALE SETUP]** key. Paste the data by holding **[SCALE SETUP]** and then pressing the **[STOP]** key. A message saying "PASTE PAGE" will be shown in the display



- Page copy operates on trigs, pitches and parameter locks. Pasting data into a track overwrites any previous notes, data and parameter locks.



- The track page paste operation can be undone by holding down the **[SCALE SETUP]** key while pressing the **[STOP]** key. A message saying "UNDO PAGE" will be shown in the display.

### CLEAR TRACK PAGE

It is also possible to clear a track page.

1. Make sure you are in GRID RECORDING mode.
2. When you are on the track you wish to clear, press and hold **[SCALE SETUP]**. Then press **[PLAY]** to clear the track. The message “CLEAR PAGE” will appear.



- The clear track page operation can be undone by holding the **[SCALE KEY]** and pressing the **[PLAY]** key directly after the clear operation. The message “UNDO PAGE” will be shown in the display.

### TRACK COPY

In GRID RECORDING mode, it is possible to copy the contents of one track to another.

1. Make sure you are in GRID RECORDING mode, indicated by the <RECORD> LED giving off a steady light. Select the source track pressing the appropriate **[TRACK]** key.
2. Press **[REC]** while holding **[FUNCTION]** to copy the data of the track. The message “COPY TRACK” will be shown in the display.

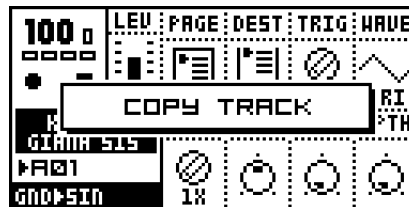

3. Select the destination track using the **[TRACK]** wheel.
4. Paste the data by pressing and holding **[FUNCTION]** and then pressing the **[STOP]** key. A message saying “PASTE TRACK” will be shown in the display.

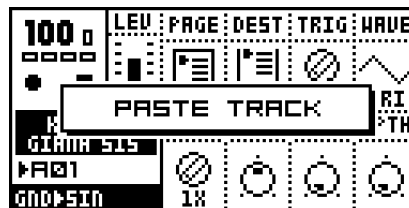

- The track data copied consists of notes, parameter locks, the machine selection, DATA pages and arpeggiator, transpose, swing and slide settings.
- Pasting data into a track overwrites any previous notes, data and parameter locks.



- The paste track operation can be undone by holding down the **[FUNCTION]** key while pressing the **[STOP]** key. A message saying “UNDO TRACK” will be shown in the display.

### CLEAR TRACK

While in GRID RECORDING mode, it is possible to clear a track.

1. Make sure you are in GRID RECORDING mode. The <RECORD> LED should be lit.
2. When you are on the track you wish to clear, press and hold **[FUNCTION]**. Then press **[PLAY]** to clear the track. The message “CLEAR TRACK” will appear.



- The clear track operation can be undone by performing the clear track operation one more time. The message “UNDO TRACK” will be shown in the display.

### PATTERN COPY

To copy the contents of a pattern to another pattern location, follow the steps below.

1. Make sure that the <RECORD> LED is **not** lit, so you are **not** in GRID RECORDING mode.

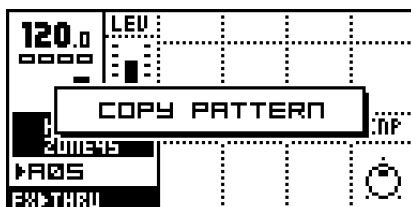

2. Select the source pattern by using the **[BANK]** and **[TRIG]** keys. Hold **[FUNCTION]** and then press **[REC]**. A message “COPY PATTERN” will be shown in the display.
3. Choose the pattern where you wish to paste your pattern data.



4. Paste the data by holding **[FUNCTION]** and then pressing the **[STOP]** key. A message “PASTE PATTERN” will be shown in the display.



- Pasting data into a pattern overwrites any previous data in the pattern.
- The pattern data that is copied consists of notes, parameter locks, the kit association, MIDI sequencer notes and arpeggiato, transpose, swing and slide settings for all six tracks.



- The paste pattern operation can be undone by holding the [FUNCTION] key and then pressing the [STOP] key. A message saying “UNDO PATTERN” will be shown in the display.

### CLEAR PATTERN

It is also possible to completely clear a pattern of all its content.

1. Make sure you are not in GRID RECORDING mode. The <RECORD> LED should be not be lit.
2. When you have chosen the pattern you wish to clear, press and hold [FUNCTION] and then press [PLAY] to clear the pattern. The message “CLEAR PATTERN” will appear

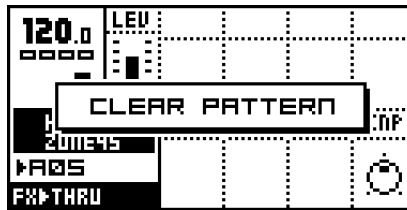

- The clear pattern operation can be undone by performing the clear pattern operation one more time. The message “UNDO PATTERN” will be shown in the display.
- Pattern clear clears everything, except the kit association.

### SUPER COPY

For track, pattern and machine copy operations the default copy behaviour can be replaced by the super copy function.

1. Hold the [FUNCTION] and [REC] for around a second and the default message-box will expand to a larger one including a selection box.

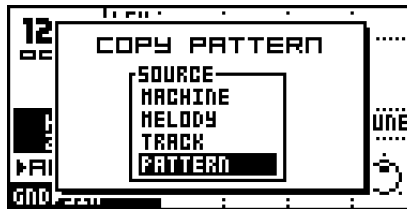

2. You can now release [FUNCTION] while holding [REC]. While still holding [REC], use the [UP] and [DOWN] keys to manoeuvre the inverted selection box.
3. When [REC] is released the selected copy action will be performed.
4. Paste the data by pressing [FUNCTION] and [STOP]. If you chose to paste a copied pattern, a window showing “PASTE PATTERN” will appear.

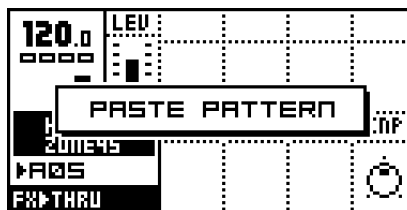



- **Melody copy** is a special copy function which copies all pitch data from the track, but excludes parameter locks and machine selection and settings. Use this to transport a melody between tracks you are using different machines for.
- The **MACHINE** selection is a shortcut for copying the machine selection and all **DATA** pages, which is normally performed from the **EDIT KIT** window.
- All super copy functions are delayed until the **[REC]**, **[PLAY]** or **[STOP]** key is released. So even if you get the message “**CLEAR PATTERN**” it is not performed until the **[REC]**, **[PLAY]** or **[STOP]** key is released, so that you get the chance to change the default action in the selection box.
- The **SUPER COPY** screen can only be called when in pattern, grid edit and kit edit modes.
- You can cancel super copy/clear/paste by pressing the **[EXIT/NO]** key.
- The super paste operation can be undone by performing the super paste operation one more time. The message “**UNDO PATTERN**” will be shown in the display (if a pattern has been copied).

### SUPER CLEAR

For track, pattern and machine clear operations the default clear behavior can be replaced by the super clear function.

1. Hold the **[FUNCTION]** and **[PLAY]** for around a second and the default message-box will expand to a larger one including a selection box.



2. You can now release **[FUNCTION]** while holding **[PLAY]**. While still holding **[PLAY]**, use the **[UP]** and **[DOWN]** keys to manoeuvre the selection box.
3. When **[PLAY]** is released the selected clear action will be performed.



- The super clear operation can be undone by performing the super clear operation one more time. An undo message will be shown in the display.

### TEMPO

The tempo in the Monomachine is a global parameter. It is however not stored in the global slots (see page 87). The tempo will control the playback speed of the patterns and also tempo synchronised parameters in the Monomachine, such as the **HOLD** parameter, the delay and LFO speeds and some machine parameters.

The tempo is controlled from the **TEMPO** screen, and can also be set by the song sequencer.

### THE TEMPO SCREEN

The tempo screen is opened by pressing the [TEMPO] key.

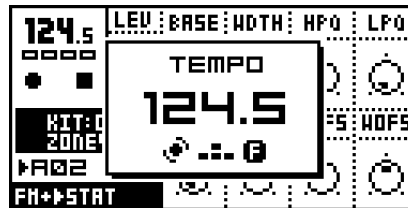

From here you can use the **LEVEL** knob to change the current tempo in integer steps. The [UP] and [DOWN] arrow keys change the decimal part of the tempo. Holding [FUNCTION] while editing the tempo will delay the change of tempo until you release the [FUNCTION] key.



- You can temporarily shift the tempo up or down by 10% by pressing the [LEFT] or [RIGHT] arrow keys. This is very handy when manually syncing your Monomachine to a turntable or a laptop. Note that you do not necessarily need to be in the TEMPO screen to perform this tempo shift.

### TAP TEMPO

To tap a tempo, hold the [FUNCTION] key and tap the [TEMPO] key in a steady rhythm.

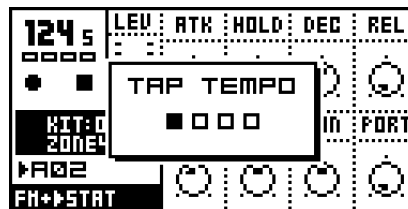

After four consecutive taps the average tempo of the taps will be set as the current tempo and it will be shown in the tap tempo window. You can continue tapping the [TEMPO] key, and the taps will be used to refine the average tempo. A maximum of 16 tempo taps are considered.

### EXTERNAL SYNCHRONISATION

The Monomachine can be set to either internal or external synchronisation. When in internal clock mode the Monomachine can output a high quality MIDI clock through the MIDI OUT port. This can be used for keeping external gear in sync with the Monomachine.

When in external MIDI clock synchronisation mode the Monomachine will stay in sync with an external MIDI clock if present. When in external clock mode the tempo in the upper left corner of the base LCD screen will show "EXT" for external synchronisation. The tempo screen will show the current average tempo. The tempo displayed in the tempo screen is only an average calculation. Even though it might appear to vary the Monomachine is tightly locked to each MIDI clock signal received.

Read more about how to set the external synchronisation of the Monomachine in section "CONTROL IN", on page 92.





- **The tempo is not stored in patterns or kits. However, songs can store tempo changes.**

### PARAMETER LOCKS

One major advantage of the Monomachine is the straightforward method to lock parameter settings to specific trigs steps. These snapshots are called *parameter locks*.

A lock is a snapshot of a parameter setting. It changes the parameter value from its original value stored in the kit, but only for that note triggering. The parameter will change back to its default state for the next trig if no further parameter locks are made for that note and parameter.

Parameter locks can be programmed in both GRID RECORDING and LIVE RECORDING mode and all parameters of the DATA pages can be locked. Parameter locks are an important tool for creating unique dynamic soundscapes with the Monomachine.

### PARAMETER LOCKS IN GRID RECORDING MODE

To program parameter locks in GRID RECORDING mode, follow the steps below.

1. Begin with following the instruction in section “RECORDING PREPARATIONS”, on page 47.
2. Enter GRID RECORDING mode by pressing the **[REC]** key. The <RECORD> LED above the key should now be firmly lit.
3. Press and hold a **[TRIG]** key for the step where you want to add a lock. Note that if there is a trig already set for the step it is not removed if you keep the **[TRIG]** held down until you see the mini-keyboard.
4. While holding the **[TRIG]** key, you can now tweak the parameter of your choice with the appropriate **DATA ENTRY** knob. You can tell that the parameter has been locked by the parameter being inverted on the LCD. Also, the <TRIG> LED above the parameter locked note will flash, indicating that parameters have been locked. You can also click the knob corresponding to an unlocked parameter to lock it to its current value. When the **[TRIG]** key is released, the trig for that step will hold the parameters that you just programmed. The parameter will be held until a new trig is played.

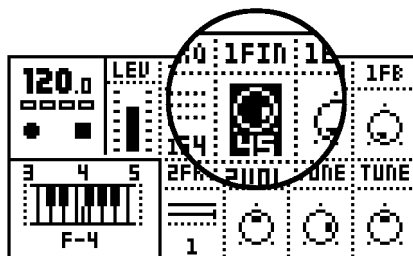

5. If you want to view the current parameter lock settings for a step, hold the **[TRIG]** key until you see the mini-keyboard appear. Locked parameters are inverted.
6. Remove a single parameter lock by clicking the **DATA ENTRY** knob while holding the **[TRIG]** key.
7. To remove all parameter locks for a step, hold the **[TRIG]** key and press the **[PLAY]** key.
8. You can copy a trig step, including pitch and all parameter locks. To do this, press and hold the **[TRIG]** key for the step you want to copy, and press the **[COPY]** to perform the

note copy. Then hold the **[TRIG]** key for the step you want to paste the trig to, and press **[STOP]** to perform the paste note operation.



- In **GRID RECORDING** mode, you can verify which steps have parameter locks by looking at the **<TRIG>** LED's. A firmly lit **<TRIG>** LED means that the corresponding step has no parameters locked, whereas a rapid interval flash indicates it does have one or more parameter locks.
- A pattern can have a total of **62** individually locked parameters divided freely between all tracks and parameters. When a parameter is locked on one step, that parameter can be locked to individual values on all the steps of the track.

**PARAMETER LOCKS IN LIVE RECORDING MODE**

In **LIVE RECORDING** mode, you can record parameter locks in real-time. To do this, follow the steps below:

1. Begin with following the instruction in section “**RECORDING PREPARATIONS**”, on page 47
2. To start recording in **LIVE RECORDING** mode, hold **[REC]** and then press **[PLAY]**. This starts the sequencer recording and the record LED will start flashing.
3. Record parameter locks by adjusting the corresponding **DATA ENTRY** knob while the sequencer is playing and recording. When changing a parameter, the parameter lock will be set to the next trig step played on the track. If a parameter is not changed between two trigs no parameter lock will be recorded for that step.
4. To remove parameter locks you need to enter **GRID RECORDING** mode and follow the instructions in “**PARAMETER LOCKS IN GRID RECORDING MODE**” on page 57



- It is often a good idea to edit and fine tune the parameter locks in **GRID RECORDING** mode, after recording them in **LIVE RECORDING** mode.

**ADVANCED SEQUENCER CONTROL**

For users that seek the most control over the creative process the Monomachine offer unique sequencer features for fine tuned sequencing.

**TRIG TRACKS**

For each track you have access to three individual sub tracks named *trig tracks*, offering individual control over the amplitude envelope, the filter envelope and the LFO trigs. This means you can separate pitch changes from envelopes and LFO triggering, allowing for very in-depth track sequencing.

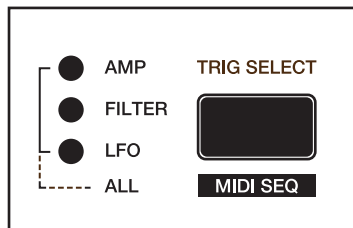

Traditionally synthesizers retrigger all envelopes when a NOTE ON event (a key pressed on the keyboard) occurs. In the Monomachine NOTE ON events can be split up, allowing you to trigger the amplitude envelope (AMP trig), filter envelope (FILTER trig) or the LFO's (LFO trig) at any step of the sequence. Please refer to the first two illustrations in Figure 7, "Trig track illustrations," on page 60.

The **[TRIG SELECT]** key cycles between which trig track is being programmed, and the <TRIG TRACK> LED's indicate the current active selection. All three <TRIG TRACK> LED's lit means the ALL mode, where trigs for all three trig tracks are set. The four states are listed below:

- **ALL** - This is the default state where all <TRIG TRACK> LED's are lit. **[TRIG]** keys pressed add or remove trigs on all three Trig tracks, and a pitch is added as default.
- **AMP** - Only adds or removes trigs on the AMP Trig track. No pitch is added as default.
- **FILTER** - Only adds or removes trigs on the FILTER Trig track. No pitch is added as default.
- **LFO** - Only adds or removes trigs on the LFO Trig track. No pitch is added as default.

When trig track AMP, FILTER or LFO is selected, the <TRIG> LED's are lit red if a trig is set for the corresponding step on the trig track selected. The <TRIG> LED's are green if the trig is not set for the trig track selected, but on some other trig track (or if it has a *Trigless Trig*, see section "TRIGLESS TRIGS", on page 59). For example, a FILTER trig will be indicated with a green <TRIG> LED when the AMP trig track is active, given an AMP trig is not placed on the same step.

When Trig Track ALL is selected, the <TRIG> LED's are lit red if a trig is set on all AMP, FILTER and LFO Trig Tracks. If one or more of them are missing then it is lit green. Steps with NOTE OFF events are lit yellow.

### TRIGLESS TRIGS

It is possible to change pitch or make parameter locks, even without triggering any envelopes. But since pitch and parameter locks are set with a **[TRIG]** key pressed, and trigs are added when the **[TRIG]** key is pressed you need to insert a trigless trig first.

The quickest way to do this is to press the **[TRIG]** key twice while holding **[FUNCTION]**. The corresponding <TRIG> LED will then first turn yellow (NOTE OFF) and then green which indicates it is a trigless trig. You can now hold the **[TRIG]** key and program a pitch or parameter lock as normal, but no envelopes will be triggered. You can add these later using the trig track functions as described in the previous section.

Normal trigs can also be converted into trigless trigs by removing the AMP, FILTER and LFO trigs manually using the trig track functions.

### PITCHLESS TRIGS

You can easily remove the pitch from a trig by pressing **[EXIT/NO]** while holding the **[TRIG]** key. The pitch from the previous note will then continue to sound for the trig.



FIGURE 7. Trig track illustrations

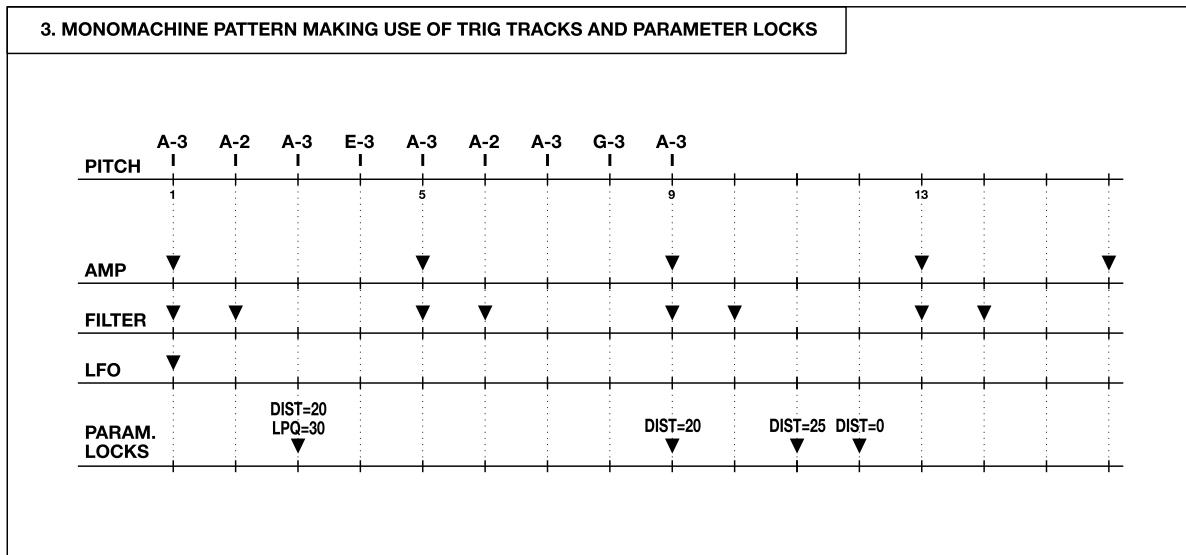
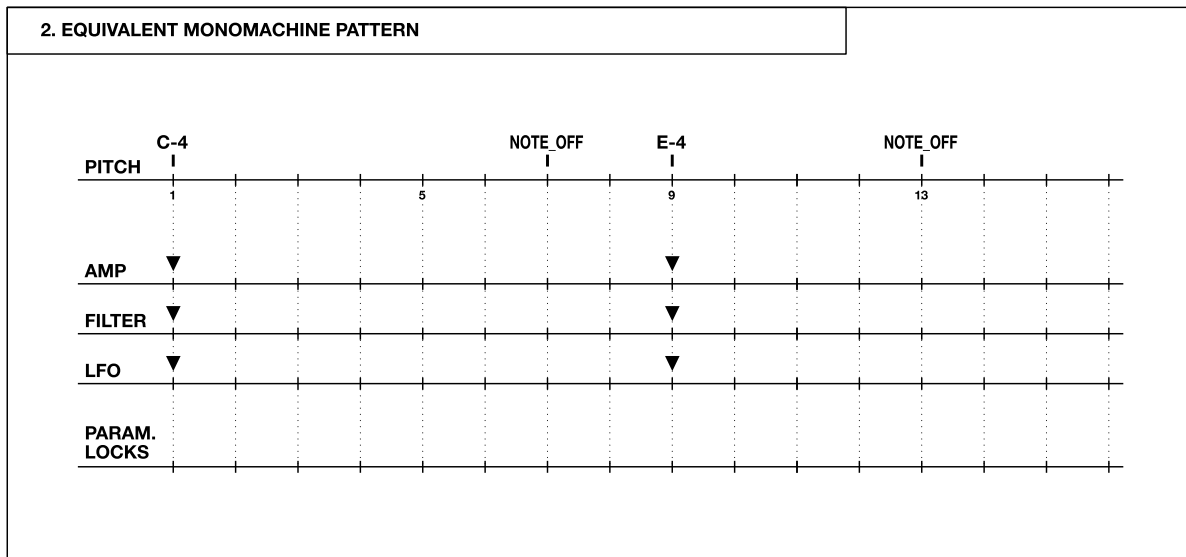
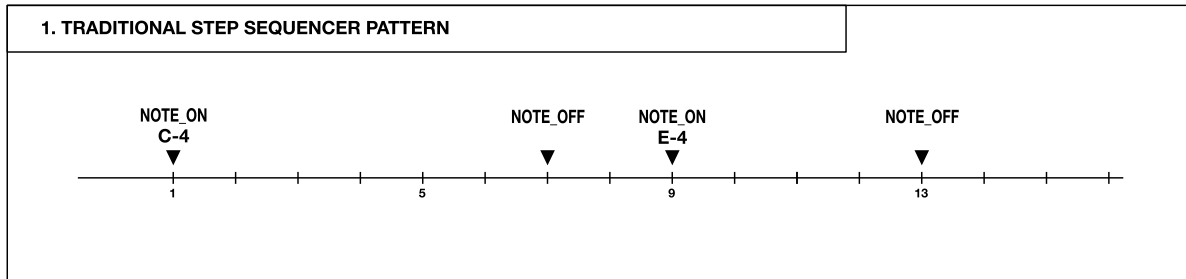

---

## ADDITIONAL SEQUENCER FEATURES

### THE ARPEGGIATOR

Each track of the Monomachine (including the MIDI sequencer tracks) offers an advanced arpeggiator. The arpeggiator is a note processor that generates rhythmic note patterns from the arpeggiator settings and notes played. Most commonly arpeggiators are used for making automated real-time monophonic cycled notes based on the chord played.

### ARPEGGIATOR BASIC SETTINGS

Each pattern offers 12 arpeggiators, one per track.

1. The arpeggiator window is opened by pressing **[ARP]** while holding **[FUNCTION]**.

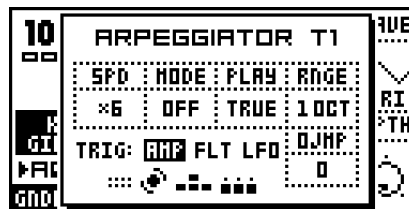

2. Select the track you want to edit the arpeggiator for using the **[TRACK]** keys.

Press **[MIDI SEQ]** while holding **[FUNCTION]** to edit the MIDI sequencer arpeggiators (see page 61 for more information on the MIDI sequencer).

The parameters are controlled using the **DATA ENTRY** knobs **A-D** and **H**.

**SPD** (speed) sets the speed of the arpeggiator. It is synchronised to the global tempo. A speed setting of 6 equals one 16th note, 12 equals 8th and so on.

**MODE** (mode) selects between four arpeggiator modes. Assuming you start with a uninitialised arpeggiator, you need to change the **MODE** from the the default value OFF to either KEY, SID or ADD.

- **OFF** - Deactivates the arpeggiator.
- **KEY** - The arpeggiator operates on the keys currently played. This is the way an arpeggiator traditionally works. When the first note is pressed the arpeggiator is activated and start playing the note repeatedly with the timing specified by the **SPD** parameter. When more notes are added the arpeggiator cycles between playing them. When keys are released they are removed from the arpeggiator cycle. When all keys are released the arpeggiator stops.
- **SID** - Keys pressed stay in the arpeggiator cycle even after a NOTE OFF command. This mode replicates the operation of the arpeggiator of the SidStation synthesizer. When only one key is pressed the arpeggiator is not activated. When more than one key is pressed the arpeggiator is activated and start playing the notes in cycle. When keys are released they are not removed from the cycle, but continue being played. The notes stay in the cycle until a new note is pressed. This way an arpeggiated chord can be held without keys being pressed down, while preparing for another chord. Stop the arpeggiato by pressing either one single key or pressing **[STOP]**.
- **ADD** - In this mode no notes are removed from the arpeggiator cycle until all keys are released. The arpeggiator start when the first key is pressed, and more notes can be

added to the cycle by pressing and releasing keys while still at least one key is pressed. This way you can build up large note-cycles quickly in auto-play sequencer style. The arpeggiator stops when all keys are released.

**PLAY** (play direction) selects between five modes of arpeggiator playback.

- **TRUE** - The arpeggiator plays the notes in the same order they were played.
- **UP** - The arpeggiator sorts the notes and plays them upwards, in rising order.
- **DOWN** - The arpeggiator sorts the notes and plays them downwards, in descending order.
- **CYCLE** - The arpeggiator sorts the notes and plays them cycling first upwards then downwards.
- **RND** - The arpeggiator plays the notes in random order.

**RNGE** (octave range) controls the octave range. If the parameter is set higher than the default "1 OCT", the arpeggiator will repeat the cycles in higher octaves repeatedly up to the specified setting.

**OJMP** (octave jump) tells the sequencer where in the arpeggiator chord the octave jump is made. '0' means after the full chord has played. '1' means one step before the end of the chord. '2' means two steps before the end of the chord and so on.



- **To activate the arpeggiator in a track, enter chords!**
- **To activate the arpeggiator on the Monomachine tabletop versions you can hold [FUNCTION] while pressing the [TRIG] keys.**
- **Copy, clear, paste and undo functions are available to the arpeggiato settings using [FUNCTION]+[REC]/[PLAY]/[STOP]**
- **To create computer-game-like arpeggiato chords, set SPD to a low value, select mode SID and turn off AMP FLT and LFO triggering as described in the section below.**

### **ARPEGGIATOR ENVELOPE TRIGGERING SWITCHES**

You will find three switches that control the envelope triggering of the arpeggiator below the four parameters described in "ARPEGGIATOR BASIC SETTINGS". You move the focus square to the right of the "TRIG:" label with the [LEFT] and [RIGHT] keys, and adjust the settings with [UP] and [DOWN].

- **AMP** = Amplitude envelope
- **FLT** = Filter envelope
- **LFO** = LFO envelope

If the label is displayed the envelope triggering connection is switched ON, and if "---" is shown it is switched OFF. If triggering is ON for an envelope, it will be triggered for each note played by the arpeggiator. All envelopes are always triggered when the first note of the arpeggiato is played.



- It can be useful to turn all envelope triggering off for fast arpeggiato speeds, and allow the envelopes to give the impression of the arpeggiated chord as one sound.
- If you are using a trigged LFO for a slow modulation of a parameter it can be useful to turn off LFO Envelope Triggering in the arpeggiator to let the LFO modulate without being restarted for each note.
- The envelope triggering switches are not available in the MIDI sequencer arpeggiators, as MIDI do not allow for such type of extended control.

### ARPEGGIATOR RHYTHM AND OFFSET TRACK

The arpeggiator offers a *rhythm and offset track* of up to sixteen steps. This can be used to make rhythmic arpeggiator patterns, one-finger melodies or very wild out-of-control arpeggiator patterns.

By default the rhythm and offset track is eight steps of length. The **LEVEL** knob is used for adjusting the length of the track. The length is indicated by the <TRACK> LED's being lit up.

Green LED's indicate that the arpeggiator is active for the step. Red LED's will be will mute out the arpeggiator for that step. Use the **[TRIG]** keys for switching the steps.

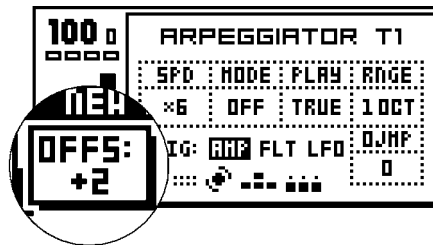

By holding a **[TRIG]** key and using the **[UP]** and **[DOWN]** keys, you can adjust the note offsets for the active steps. The current offset is displayed while the **[TRIG]** key is held in a small popup-window in the lower left corner of the LCD.



- Given the flexibility of the arpeggiator, you can think of it as a mini-sequencer within a sequencer. Using different SPD values and lengths of the rhythm and offset track can greatly affect the rhythmic structure of a pattern.

### TRANSPOSE

Each track of the Monomachine (including the MIDI sequencer tracks) offers transpose settings. Transposing in the Monomachine is made real-time and the pattern data programmed is not affected.

1. The transpose window is opened by pressing **[TRANSPOSE]** while holding **[FUNCTION]**.

2. Select the track you want to edit the transpose settings for using the [TRACK] keys.

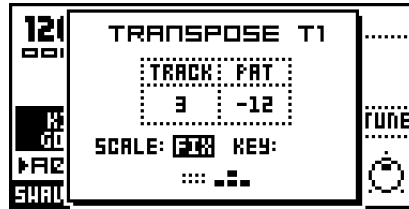

**TRACK** (track transpose) sets the individual track transpose in semitones for the selected track. The parameter is controlled with **DATA ENTRY** knob **A**.

**PAT** (pattern transpose) controls the transpose setting for the full pattern. This parameter is the same for all tracks. Use the **DATA ENTRY** knob **B** on the first row to alter the transpose amount.

**SCALE** (scale) is set per track. To alter this parameter, move the inverted focus square with the [LEFT] and [RIGHT] keys, and adjust the settings with [UP] and [DOWN].

- --- - The notes are transposed the exact amount of notes specified by the sum of the track, pattern, song and multi trig transpose. This is the normal mode. No **KEY** value can be set.
- **FIX** - Only the track transpose is used for transposing. No **KEY** value can be set.
- **MAJ** - The transposed notes are kept within the Major scale specified by the **KEY** value.
- **MIN** - The transposed notes are kept within the Minor scale specified by the **KEY** value.

**KEY** (key) is only available for certain **SCALE** selections and defines in which key the **MAJ** and **MIN** scale selections will be.



- **Set SCALE to "FIX" for tracks playing percussive sounds. If the track is transposed in a song or using multi trig transpose the percussion will then keep its sound while melodic tracks are transposed.**

## SWING

Swing can be used for adding shuffle, or other sub-step rhythmic adjustments to a pattern. The swing settings are saved as part of the pattern.

1. The SWING window is opened by pressing [SWING] while holding [FUNCTION].
2. Select which track you want to edit the swing settings for using the [TRACK] keys.

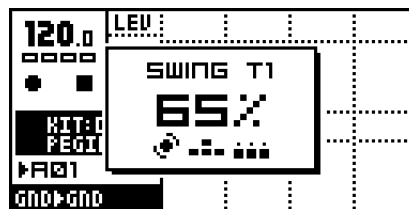

Use the **LEVEL** knob to control the swing amount. The swing amount is set between 50% and 80%. 50% is the default value which makes the pattern unaffected by swing, and the



maximal value is 80%. The swing amount parameter is the same for all the tracks of the pattern. Each track however has its own swing track.

Green <TRIG> LED's indicate the steps that will be time-shifted by swing, and the [TRIG] keys are used to switch their state. Use the [SCALE] key to cycle between the pages.

**THE SWING TRACK**

As default, the swing is programmed to shift every second 16th note, starting on step 2. This is how the swing pattern will be restored after a pattern clear operation (see page 54) or swing clear operation. This gives the traditional "shuffle"-style swing for a 4/4 normal speed pattern.

In double speed mode (see page 55) you need to modify the swing pattern to get the same result as was given by the default swing pattern in single speed mode, activate swing for every fourth note, starting with the third note.

Please check figure "Swing example" below for an example of the swing effect with different swing amount and swing track settings. The first eight steps use the default "shuffle" setting and the last eight use an edited swing track setting.



- When the Monomachine is locked to external MIDI clock, the swing amount will be quantised to the resolution of the MIDI clock, leaving only four effective swing amounts.



- Copy, clear, paste and undo functions are available on the swing tracks using [FUNCTION]+[REC]/[PLAY]/[STOP]

FIGURE 8. Swing example

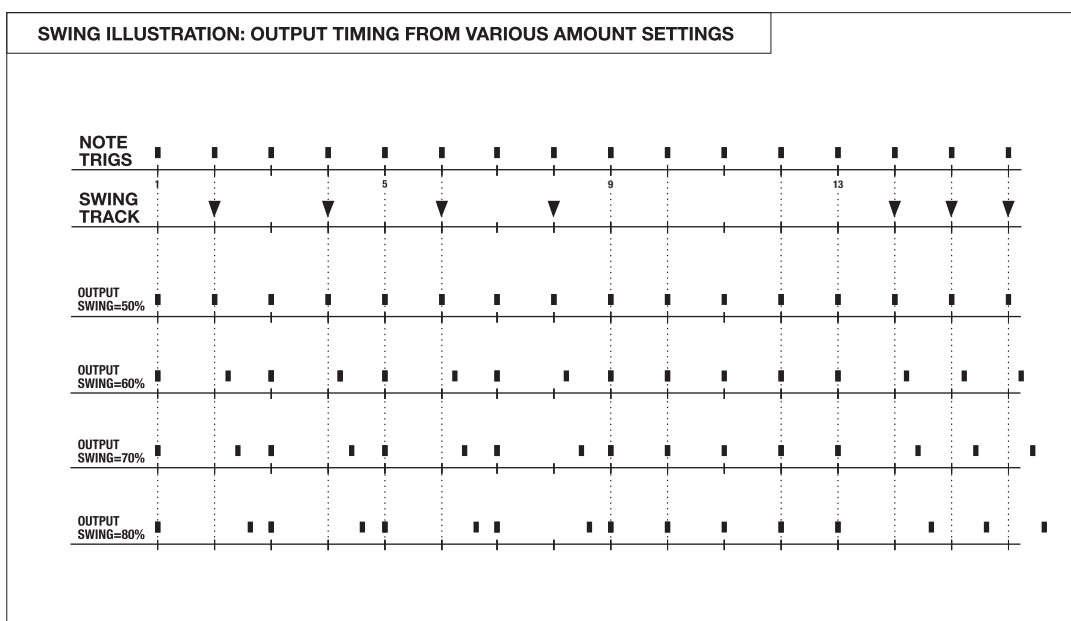

## SLIDE

The default behavior for parameter locks is that the value changes exactly when the step is played. By using the slide function, the parameter value changes made by parameter locks can be slid smoothly between the locked values. The slide tracks are saved as part of the pattern.

1. The SLIDE window is called by pressing **[SLIDE]** while holding **[FUNCTION]**.
2. Select the track you want to edit the slide track for using the **[TRACK]** keys.

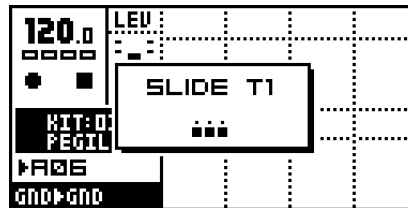

The <TRIG> LED's indicate which steps will slide, and the **[TRIG]** keys are used to switch their state. If your pattern is longer than 16 steps, use the **[SCALE]** key to cycle between the pages.

For a parameter to slide it needs to be locked at two steps. If the slide track is set for the same step as there is a parameter lock, the parameter will slide to the next value it is locked to. The speed of the slide is relative to the current tempo. The slide is always completed exactly when the next step with the same parameter locked is reached.



- **Only parameters locked on the steps selected in the slide track, and on a later step, will slide. Parameters that are unlocked, or only locked at one step will not slide.**
- **If there are trigs in between the two locked parameter where the parameter is not locked, the parameter will slide between the two locked positions and is not interrupted by the unlocked trigs in the middle.**



- **Copy, clear, paste and undo functions are available on the slide tracks using **[FUNCTION]+[REC]/[PLAY]/[STOP]****

The figure "Slide illustration" below show an example of how the slide track influence a locked parameter. The first slide trig makes the parameter slide to the next locked parameter value. Even though there is a trig in the middle it does not interrupt the slide. When the destination is reached the locked value is held and not slid, as there is no slide trig for that position. For the last three slide trigs, it is only the middle one that is causing any slide, as the other slide trigs do not have any parameter locked at the same step.

FIGURE 9. Slide illustration

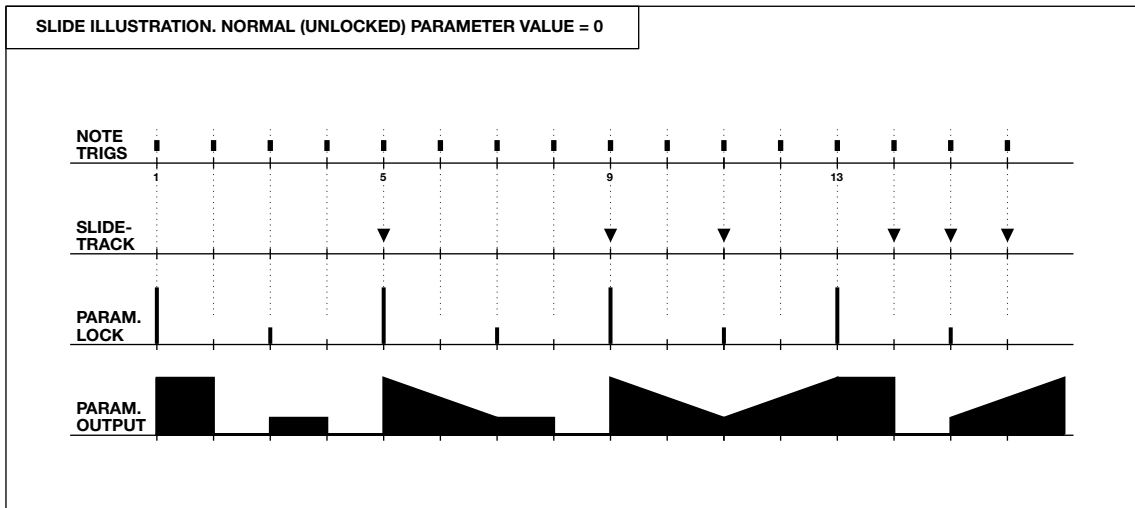

**THE MUTE MODE**

Track muting is normally performed by pressing the [TRACK] keys while holding [FUNCTION]. The Monomachine offers an additional interface for controlling the track muting. When one hand operation is preferred, or when you want simultaneous access to both the internal and the MIDI sequencer mute tracks at once, the MUTE window is the solution.

The the MUTE window by pressing [BANK] while holding [FUNCTION].

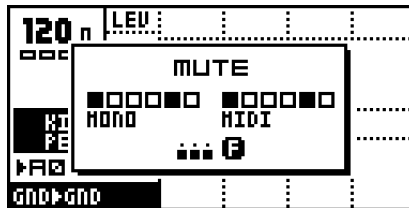

The six first boxes refer to the six internal Monomachine tracks. In the window above all tracks are un-muted. The six last boxes refer to the six MIDI sequencer tracks. Toggle the Monomachine tracks between muted and un-muted using [TRIG] keys 1-6. The MIDI sequencer tracks are reached through the [TRIG] keys 9-14. A muted track will be displayed as a "-" sign. The corresponding <TRIG> LED indicate the Mute-state of the track. If it is lit the track is not muted.

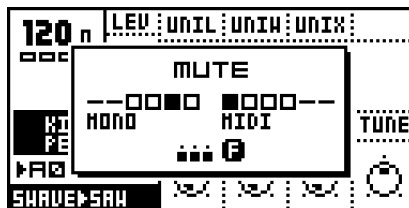

In addition to the <TRIG> LED's, the Mute-state is indicated in the MUTE window. Boxes means that the track is un-muted, and a dash means it is muted. The <TRACK> LED's will also be updated.

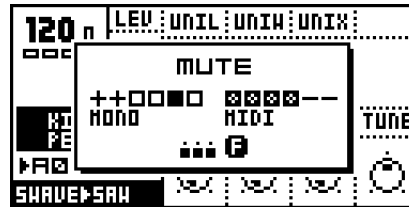

If you press the [TRIG] keys while holding [FUNCTION] the mute change is held until [FUNCTION] is released. A track that is currently muted but will be un-muted when [FUNCTION] is released is displayed as a "+" sign. A track that is currently not muted but will be muted when [FUNCTION] is released is displayed as an "X" sign.

### MINIMISING THE MUTE WINDOW

While working in MUTE mode, the MUTE window hide large parts of the main interface screen. This can be disturbing if you want to work with mutes at the same time as accessing the sound parameters.

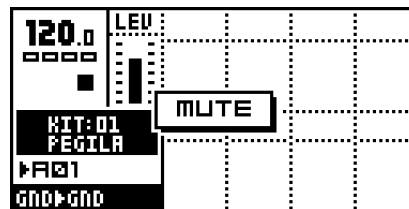

To avoid this problem, the MUTE window transforms to a small centered window when a **DATA ENTRY** knob is accessed while in MUTE mode. To return to the big MUTE window, press the [ENTER/YES] button.



- The mute works on note level. That means that sounds already triggered will continue sound, but further trigs will be masked. This allows sounds to fade out in a natural way.



- The track mutes are true global parameters, just like tempo. A muted track remains muted, even when the pattern is changed or song mode is entered or exited.
- Mute settings are remembered between reboots.

## POLY MODE

In normal operation the Monomachine offers six tracks of multitimbral monophonic sound synthesis. Ensemble machines (see Appendix A for more information) can be used to make up to four notes chords using only one track, but for using the other machines polyphonically you need to enter the POLY mode.

1. Press **[POLY]** while holding **[FUNCTION]** to enter POLY mode. The POLY mode is indicated by both the <PATTERN> and <SONG> LED's being lit.

In POLY mode all six Monomachine sound engines polyphonically generate the sound of only one track. All tracks beside the one currently selected with the **[TRACK]** keys are disabled. The currently selected track instead offers six notes of polyphony.



- In POLY mode, the internal sequencer operates polyphonically. You can use chords to generate polyphonic chords. Just remember that all other tracks except the one currently selected are disabled while in POLY mode.

## THE MIDI SEQUENCER

Each of the six internal sequencer tracks of the Monomachine sequencer is teamed with a MIDI sequencer track for controlling external MIDI gear. The six MIDI sequencer tracks are part of each pattern and operate individually, although with a few connections with the internal tracks since the LFO's are shared between the internal tracks and the MIDI sequencer tracks. The MIDI tracks play simultaneously and synchronised with their internal counterparts.

1. Switch between internal sequencer and MIDI sequencer editing by pressing **[MIDI SEQ]** while holding **[FUNCTION]**.
2. MIDI track editing is indicated by all the <TRIG TRACK> LED's being unlit, and the four uppermost <DATA PAGE> LED's lit.

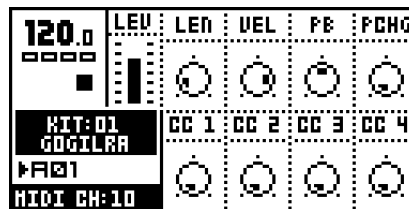

## USING THE MIDI SEQUENCER

The Monomachine MIDI Sequencer is used almost identically to the internal sequencer. The main difference being that no internal sound is generated, data is only transmitted on the MIDI OUT port, for controlling external MIDI gear.

Use the **[TRACK]** keys to select the MIDI track you wish to edit. Note that MIDI tracks are muted separately from the internal tracks with the **[TRACK]** keys while holding **[FUNCTION]**, or through the special MUTE mode interface (see section "THE MUTE MODE", on page 67).

To use the MIDI sequencer you need to connect the MIDI OUT port of the Monomachine to the MIDI IN port of another MIDI device. The external MIDI device needs to listen to the MIDI channel of the Monomachine MIDI track in focus. The keyboard, **[TRIG]** keys and MIDI sequencer output of the track is now directed to the MIDI channel selected in the Global "MIDI SEQUENCER SETTINGS" menu page (see section "MIDI SEQ SETTINGS", on page 108 for more information).

Please refer to sections "GRID RECORDING" on page 47 and "LIVE RECORDING" on page 49 for information on how to input notes in the sequencer.



- **Chords can be entered in the MIDI sequencer, but all notes of the chord need to be the same length. If you want to play true polyphonic notes you need to make use of several tracks and direct the output to the same MIDI channel.**



- **Parameter locks can be used by the MIDI sequencer, which is very handy to control for example the filter cut off parameter of an external synth.**

### THE MAIN MIDI SEQUENCER INTERFACE

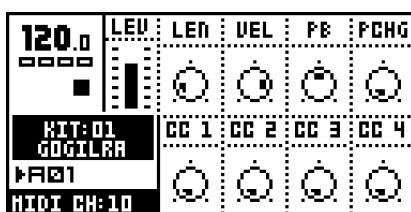

**LEN** (note length) sets the maximum time the note will be played until a NOTE OFF is sent. Notes can also be interrupted with NOTE OFF trigs (set by pressing a **[TRIG]** key while holding **[FUNCTION]**). If you prefer to stop notes with only NOTE OFF trigs, set LEN to the maximum value. Notes will then have infinite length. Use parameter locks to set different note lengths for different steps.

**VEL** (velocity) controls the MIDI velocity sent for each note. Use parameter locks to set different velocity values for different steps.

**PB** (pitch bend) controls the MIDI pitch bend setting.

**PCHG** (program change) can be used for outputting MIDI program change commands, in order to change the patch of the external MIDI device. The **PCHG** parameter only transmits data when parameter locked. It is not possible to slide this parameter.

**CC 1-4** (control change 1-4) set the control change parameter values. Which parameters that are used is set in the Global “MIDI SEQUENCER SETTINGS” menu page (see page 108 for more information).

### COMPARISON WITH THE INTERNAL SEQUENCER

The MIDI sequencer tracks function to some degree like their internal counterparts. Below is a list of similarities and differences:

- The MIDI sequencer tracks do not offer any trig tracks, since MIDI does not allow for such type of extended control.
- The MIDI sequencer offers six additional arpeggiators with individual settings, but they do not offer any envelope triggering switches for the same reason as mentioned above.
- The MIDI sequencer tracks offer individual swing and slide tracks, but the swing amount is a common parameter for the pattern.
- The MIDI sequencer offers individual track transpose, but the pattern transpose is a common parameter for the whole pattern.
- The MIDI sequencer tracks share the LFO's with their equally numbered internal sequence tracks.



- **The settings of the main MIDI sequencer interface is stored as part of the kit. If you make changes to the parameters you need to save the kit in order to keep them.**



- **The internal sequencer also transmits MIDI. If you want more tracks for controlling external MIDI gear you can mute the audio output of internal tracks, enable MIDI output and use them only for controlling external gear, extending the six MIDI**



sequencer tracks. Read more about how to configure the MIDI output of the internal sequencer in section “CONTROL OUT1”, on page 91. Note though that the same parameters won’t be available. Note off commands are also handled different when MIDI sequencing using the internal tracks. On the internal tracks you need to insert a NOTE OFF trig. For more info about NOTE OFF trigs, see “OVERVIEW OF GRID RECORDING MODE” on page 12.

- The Monomachine makes distinction between MIDI sent out of the unit and MIDI received. Even if the same MIDI channel is selected for one track of the MIDI sequencer and the one track of the internal sequencer, the MIDI sequencer will not control the internal sounds, as the MIDI sequencer data is only going out through the MIDI OUT.
- As the MIDI sequencer tracks are part of the pattern, they will also be played as part of the multi trig and the sequence start playback options. This allows tight integration of external MIDI gear in a Monomachine performance.



## THE SONG MODE

The Monomachine song sequencer is a tool for setting up sequences of patterns. Each song row can have unique settings for selected parameters such as pattern start, offset and length, repeats, tempo, mute information, and transposes. The song mode can be used for making a fully arranged song or for setting up looped sets of patterns for live use. A song can have up to 200 rows, and there are 24 song slots.

To enter SONG mode by press the **[PATTERN/SONG]** key, so that the <SONG> LED is lit. The screen will change to make room for the song list.

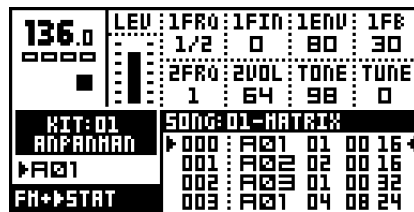

### LOAD SONG

1. To load a song, you first need to open the SONG window by pressing the **[KIT/SONG]** key.

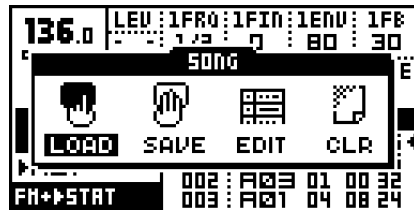

2. Use the **[ARROW]** keys to move the focus to the LOAD icon and press **[ENTER/YES]**.

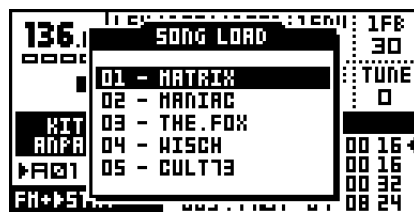

3. Choose the song you wish to load by using the **[UP]** and **[DOWN]** arrow keys. Press **[ENTER/YES]** to load the song.



- Loading a song will destroy any unsaved changes to the current song. Make sure to store unsaved work you wish to keep before loading a new song.



- Pattern/Song mode selection is remembered between reboots.

### SAVE SONG

1. Open the SONG window by pressing the **[KIT/SONG]** key. Use the **[LEFT]** and **[RIGHT]** keys to move to the SAVE icon.

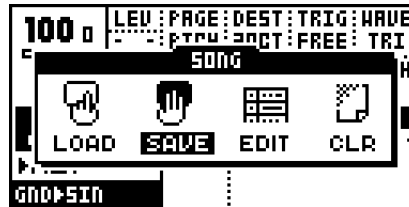

2. Press **[ENTER/YES]** to call the SAVE SONG menu.



3. In the menu, you find a list of the songs stored in memory. Use the **[UP]** and **[DOWN]** keys to choose among the 24 song slots. Press **[ENTER/YES]** to select the slot where you want to save your song.
4. A window opens where you can name the song.



Select characters using the **[UP]** and **[DOWN]** arrow keys or by using the **LEVEL** knob. The **[LEFT]** and **[RIGHT]** keys move the cursor backwards and forwards on the line.

5. Holding the **[FUNCTION]** key gives access to the “high score” selection method, in which you see all characters at the same time. Keep the **[FUNCTION]** key held while navigating using the **[LEFT]**, **[RIGHT]**, **[UP]** and **[DOWN]** buttons. Release the **[FUNCTION]** key, when you have found the right letter.



6. Once you are done naming the song, press **[ENTER/YES]** to save it.
7. If you want to exit without saving the song, press **[EXIT/NO]**.



- The commands copy, paste, clear and undo are available in the **SAVE SONG** and **LOAD SONG** menus.



- **Accurate playback of a previous song depends on the patterns it uses being unchanged since saving. Otherwise, the song will sound different.**

### SONG PLAY

To start playing a song, make sure that you are in SONG mode, and that a song is presently loaded or created.

1. Start the playback of the song by pressing [PLAY]. Pressing [PLAY] again pauses the playback. To stop the playback, press [STOP].
2. At any time you may switch back and forth between the song and the pattern mode by pressing the [PATTERN/SONG] key. The song pointer will be held until [STOP] is pressed. This way you can hold the song replaying, looping a pattern in pattern mode, until returning to song mode, continuing replaying the song at the position you left it.

### SONG TRANSPORT

While playing a song, it is possible to freely navigate within the patterns of the song.

1. Use the [UP] and [DOWN] keys to move the two song pointer position indicators at the left and right of the song list. They are shaped as two arrows. Press [ENTER/YES] to move the playback position to the position of the arrows.

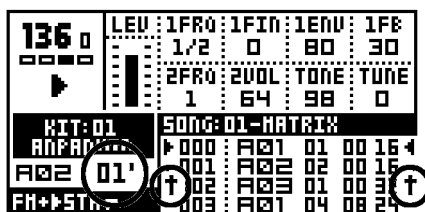

2. The arrows will flash and alternate between flashing toward the row and in the direction of the current song position. When a song row is repeated the number of remaining repeats flashes to the right of the current pattern index.
3. Once the current pattern has played to the end or the number of repeats has been completed the playback will continue from the row indicated by the arrows.



- **The song is played to its end and then it stops. Of course, infinite loops make never ending songs.**
- **If the song has tempo adjustments programmed the current global tempo will be changed.**



- **Monomachine sends and recognises MIDI Song Pointer Position. This means that you can control the position in the song list from an external sequencer, and you can control an external sequencer from the Monomachine.**
- **[STOP] stops the playback, but holds the song pointer position. A second [STOP] moves the song pointer position to the beginning of the song.**

### SONG EDITING

The song editor is where the song is built. Here patterns are assigned to the song. The behavior of the patterns is also set in the song editor.

1. Press the **[KIT/SONG]** key to open the SONG window. Move the cursor to the EDIT icon using the **[ARROW]** keys.



2. Press **[ENTER/YES]** to open the EDIT SONG screen.



This is the main screen where you arrange your patterns into a song. You can edit the song while it is playing. The two filled arrows on each side of one of the rows are the song position pointers. They indicate which song step the sequencer is currently playing. In the header of the menu, next to the text “EDIT SONG” there is a counter, indicating how many bars and beats the song has played.

Use the **[UP]** and **[DOWN]** keys to select the song row you wish to edit. The **[LEFT]** and **[RIGHT]** keys allow you to move the focus between columns. The **LEVEL** knob alters the value of each setting.

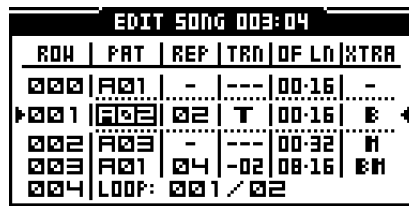

**ROW** (song row) is the amount of steps the song consists of. A song can consist of a maximum of 200 rows. The song is played from row 0 to the end row.

**PAT** (pattern) is the column which shows which pattern is assigned to the row. Set the pattern you want to be played on the song row using the **LEVEL** knob, or by pressing the appropriate **[BANK]+[TRIG]** keys. You can also program loops in this column. See section “SONG LOOPS”, on page 78 for more information on this. “END” marks can also be set from this column. It can be found as the first item in the list of patterns, and marks the end of the song, where the sequencer will be stopped.

**REP** (repeat) is the column where you control how many times the song row will be repeated. Use the **LEVEL** knob to alter the number of repeats.

**TRN** (transpose) sets a pattern transpose for the song row. Use the **LEVEL** knob to control the value. By pressing **[ENTER/YES]** you enter the SONG TRACK TRANSPOSE window, where individual transpose can be set for the tracks. If an individual song track transpose is set for a row, it is indicated by a bold "T" in the TRN column. You then need to enter the SONG TRACK TRANSPOSE window to see both the pattern and the individual track transpose. See section "SONG TRACK TRANSPOSE", on page 79 for more information on song track transpose.

**OF LN** (offset and length) is a column that can be used to override the default start offset and length settings for the pattern of the row. The default start offset of a pattern is always zero as this means to start playing from the beginning. The default length is set from scale setup (see section "SCALE SETUP", on page 46). The song row offset and length functions can be used to build complex rhythm structures. It can also be used for exchanging parts of a pattern, to add for example a fill in to the end of a pattern. Use the **LEVEL** knob to control the settings.

**XTRA** (song extra) column can be used for setting song row mutes and song row BPM. If any mute is set for the row, it is indicated by a bold "M" in the XTRA column. If a new BPM is set for the row, it is indicated by a bold "B". Press **[ENTER/YES]** to enter the SONG EXTRA menu. Please see section "SONG EXTRA", on page 79 for more information.



- To insert a row in the song, use **[FUNCTION]** together with the **[DOWN]** key.
- To remove a row in the song, use **[FUNCTION]** together with the **[UP]** key.
- Copy, paste, clear and undo functions operate on rows in song edit

### SONG EDIT TRANSPORT

It is possible to start playback from any row position in a song.

1. Move the editing focus to the row you wish to start the playback from and press the **[ENTER/YES]** button.
2. If the song is currently playing when you select another row, you will see two hollow arrows on each side of the newly selected row. They indicate that the selected row will play next once the current row reaches its end.

EDIT SONG 026:02						
ROW	PAT	REP	TRN	OF LN	XTRA	
005	A01	-	---	00-16	-	◀
006	A02	-	---	00-16	-	
007	<b>A01</b>	-	---	00-16	-	▶
008	A03	-	---	00-16	-	
009	A01	-	---	00-16	-	



- In the right part of the title bar the current song pointer position is displayed in bars and beats. This information is also updated when a new song pointer is set with **[ENTER/YES]**. This information can be used for synchronising the Monomachine song construction with the song of another sequencer.
- Use the loops and jumps to creating a live setup.

### SONG LOOPS

Song loops are a useful tool when creating a song. By using this command you can limit the number of rows and make the structure of the song clearer. They can also be used for setting up pattern loops in order to extend the limit of maximum 64 steps per pattern.

EDIT SONG 028:01						
ROW	PAT	REP	TRN	OF LN	XTRA	
005	A01	-	---	00-16	-	
006	A02	-	---	00-16	-	
007	LOOP: 005/03					
008	A03	-	---	00-16	-	
009	A01	-	---	00-16	-	

To create a loop, turn the **LEVEL** knob in the PAT column to the position right before the A01-pattern, after the END indicator. Use the [LEFT] and [RIGHT] keys to navigate between the different columns.

When a loop is selected the second edit column controls which row to jump back to. Use the **LEVEL** knob to control this. The third column selects how many times the loop should be repeated.



- Loops can be nested (that is, loops within other loops).
- A set of infinite loops can be very useful in a live setting. With a set of infinite loops, the song transport functions can be used to jump between the looping patterns.

### SONG JUMP

A loop can be converted into a forward jump. Insert a jump by turning the **LEVEL** knob so that the number of the second loop row becomes a number that is greater than the current row number. The jump command will appear and no loop count column will be available. Use the [RIGHT] arrow key to move the focus to the column where you insert which song row you want the song position pointer to jump to.

EDIT SONG 028:01						
ROW	PAT	REP	TRN	OF LN	XTRA	
005	A01	-	---	00-16	-	
006	A02	-	---	00-16	-	
007	JUMP: 01					
008	A03	-	---	00-16	-	
009	A01	-	---	00-16	-	

### SONG HALT

If you set the loop to jump to the current row it will change to a HALT statement. When the song pointer reaches a HALT statement it will pause the playback. You then need to use

the song transport controls as described in “SONG EDIT TRANSPORT” on page 77 to select a new position to start from.

EDIT SONG 028:01						
ROW	PAT	REP	TRN	OF LN	XTRA	
005	A01	-	---	00-16	-	
006	A02	-	---	00-16	-	
007	HALT:	007				
008	A03	-	---	00-16	-	
009	A01	-	---	00-16	-	

### SONG TRACK TRANSPOSE

Here the transpose settings for the patterns in a song are controlled.

1. By pressing **[ENTER/YES]** in the transpose column of the EDIT SONG window you reach the SONG TRACK TRANSPOSE menu.
2. Use the **[RIGHT]** and **[LEFT]** keys to move between the columns, and also to reach the lower row. Use **LEVEL** to update the parameter values. Use the **[UP]** and **[DOWN]** keys to move between the song rows. Press **[EXIT/NO]** to exit the SONG TRACK TRANSPOSE window.

SONG TRN ROW:001						
TRN	TR1	TR2	TR3	TR4	TR5	TR6
+02	<b>T03</b>	---	---	---	-10	---
MIDI	+04	---	+04	---	---	---

**TRN** (pattern transpose) control the pattern transpose.

**TR1..6** (track 1-6 transpose) controls the individual track transpose for the six internal Monomachine tracks. The six parameters on the MIDI row control track transpose for the six MIDI sequencer tracks.



- The track transpose settings made are only valid on that particular row.



- If individual track transposes are set for a row, the transpose value in the EDIT SONG window is exchanged for a bold “T”. You then need to enter the SONG TRACK TRANSPOSE window to check the settings.

### SONG EXTRA

The SONG EXTRA window is the interface for controlling song row mutes and song row BPM settings.

1. Reach it by pressing **[ENTER/YES]** in the SONG EXTRA column in the EDIT SONG window..

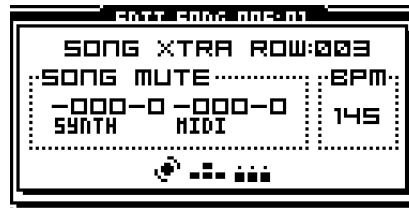

From here you can set the mutes for the song row. Use the **[TRIG]** keys 1 to 6 to set the mute mask for the internal tracks, and **[TRIG]** keys 9 to 14 for the MIDI sequencer tracks. A muted track will be displayed as a “-” sign.

Tempo adjustments can be programmed by setting a BPM value. Use the **LEVEL** knob to update the BPM setting. You need to start by increasing the assigned BPM-value. To remove the BPM value, turn the **LEVEL** knob so that the lowest possible value is selected. You will then see “-” printed in the BPM tab.



- If no BPM value is set for the step, the current tempo is used. If a song does not have any tempo settings, the current tempo is used for the full song.



- The global mutes applies as well as the song row mutes. Tracks muted in the global mutes (as described in section “THE MUTE MODE”, on page 67) or the song row mutes will be muted on that row.
- If a song row mute mask is set for the row, it is indicated in the XTRA column with a bold “M”. If a song row BPM value is set, it is indicated with a bold “B”.



---

## MONOMACHINE ROUTING

The Monomachine offers a flexible routing system for addressing the audio outputs, as well as using the audio inputs and routing between the synthesis and FX machines.

Most of the routing is controlled from the EDIT KIT TRACK:1 window. Please check section "ASSIGNING A MACHINE TO A TRACK", on page 22 for information on how to find, open and manoeuvre it.

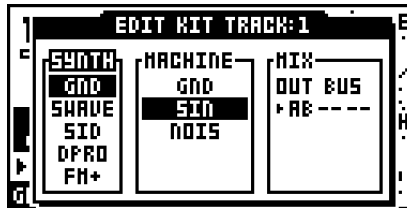

### THE MONOMACHINE MIXER

The **OUT BUS** parameter in the MIX tab is available for all machines. It selects which mix busses the track will be sent to. The Monomachine offers three stereo mix busses named AB, CD and EF. At the end of the mix bus the sound is by default sent to the audio output pairs AB CD and EF.

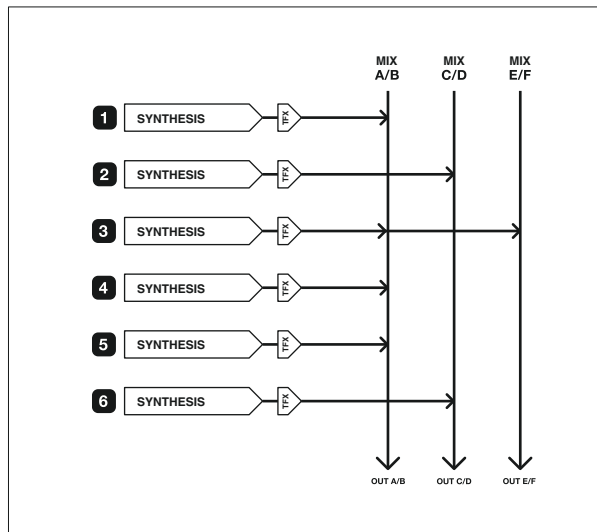

If no FX Machines are used the mix bus selection simply selects the audio stereo output(s) the track will be sent to. In the example above the synthesis tracks are sent to different audio outputs, so further external audio processing is possible for the individual tracks. The third track is sent to two outputs.

### THE FX MACHINES

The FX Machines works a little bit different compared to the synthesis machines as they do not generate any sound themselves. They need to be fed sound in order to work as supposed. The sound sources can either be the audio inputs, the sound of the previous track or the audio coming from one of the mix busses.

**USING THE AUDIO INPUTS**

Audio can be routed from the external inputs and be effected with both track effects and FX machines. The audio inputs are available to the FX machines found in the Monosynth named "FX". Follow the steps below to assign

1. Press the **[KIT/SONG SETUP]** key to open the KIT window. Move the focus to the EDIT icon and press **[ENTER/YES]** key.
2. Scroll down to the FX machines. You will find this selection at the end of the list.

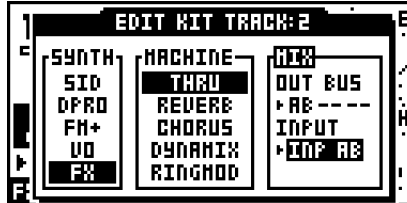

3. The THRU machine is a good starting point as it will just let the audio from the source selected through without other processing but a signal amplifier and of course the track effects. Assign the THRU machine to a track.
4. Use the **[LEFT]** and **[RIGHT]** keys go to the **INPUT** parameter field and select INP A, INP B or INP AB. Please note that the **INPUT** parameter field does not appear until an FX machine is selected with **[ENTER/YES]**.
  - **INP A** - Monophonic audio is used from Audio Input A.
  - **INP B** - Monophonic audio is used from Audio Input B.
  - **INP AB** - Stereo audio is used from Audio Input A and B.



- **Before any sound is heard from the audio input you need to trig the track so the machine is activated. Play any note for the track; the pitch of the key is ignored by the THRU machine.**

In the routing example below synthesis machines are mixed with FX machines with input taken from the audio inputs. The audio inputs are only printed explicitly in this example.

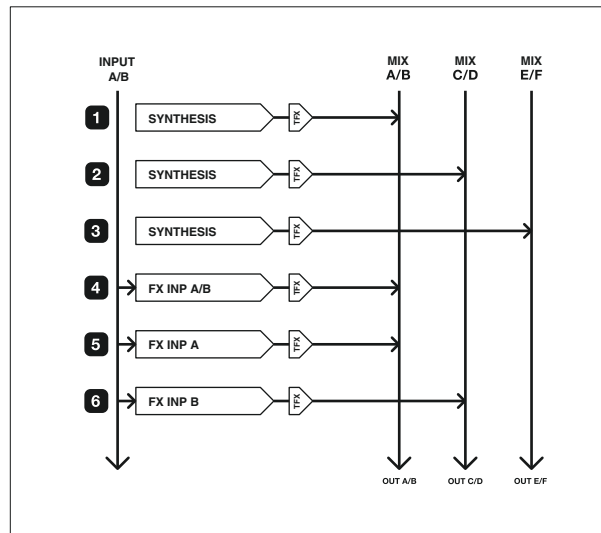



- All track effects, the LFO's and the sequencer are still at your hands when using the audio inputs! Set up six tracks with various track effect settings, LFO settings and use the sequencer on top of this, and you have a unique and powerful effects processor.
- The output of the tracks always pass through the track effects, of which the amplifier envelope is part. If you want the audio to pass through without decaying you need to set DEC and REL to their maximum levels (127) and retrigger the machine.

**NEIGHBOUR ROUTING**

The FX machines can also take their inputs from internal synthesis sound of the Monomachine. One of the modes for this is the NEIBOR mode. To use this mode, set track number two or higher to use an FX machine, and set INPUT to NEIBOR.

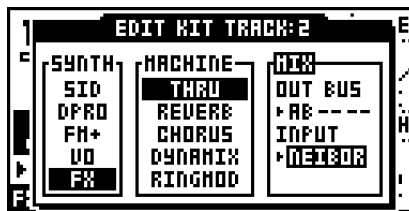

In NEIBOR mode, the output of the previous track is used directly, and fed into the input of the FX machine of the current track. Only the input of one track is used for the input, but NEIBOR FX machines can be chained.

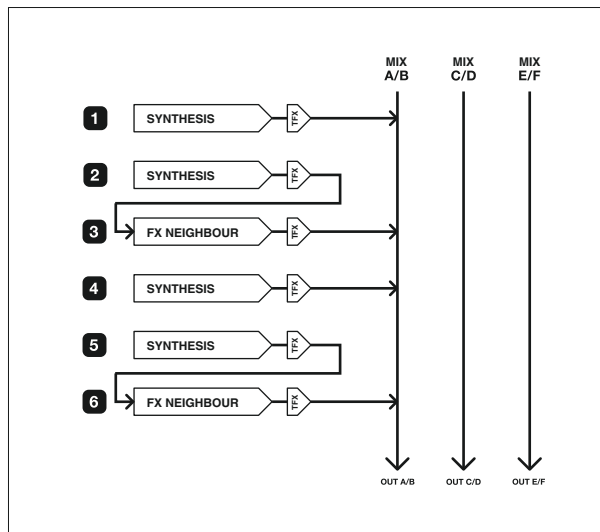

In the example above all audio outputs are set to the main AB mix bus. Track 2 and 6 is routed to FX machines set to NEIBOR mode, and the input is taken directly from the previous track. All outputs are turned off for track 2 and 5.



- Use the neighbour FX to get access to an additional track effect! If you rather want the distortion to be applied after all other effects, you can assign a THRU FX

machine in NEIBOR mode to the track after, and all the track effects of the second track will be applied after the first one. Just remember to turn off the outputs of the first track.

- NEIBOR mode is good for quick FX routing, when no more than one track need to be fed into the FX.

**MIX BUS ROUTING**

For applying an effect to two or more mixed tracks you need to use the mix buses as input for the FX machine. To use this mode, set track number two or higher to use an FX machine, and set INPUT to "BUS XX", where XX is the mix bus AB, CD or EF.

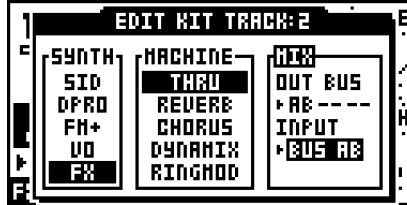

When the output of a track in the Monomachine is set to AB, CD or EF, it is fed to one of the three mix buses, which by default ends in the audio outputs with the same names. The tracks are mixed in the same order as their index, with track 1 first.

The contents of the mix bus can be used as input for the FX machines. If the same bus is used for input and output, the FX is applied as an insert effect. If another bus is used to output the FX output is mixed into the track normally, just like synthesis machines.

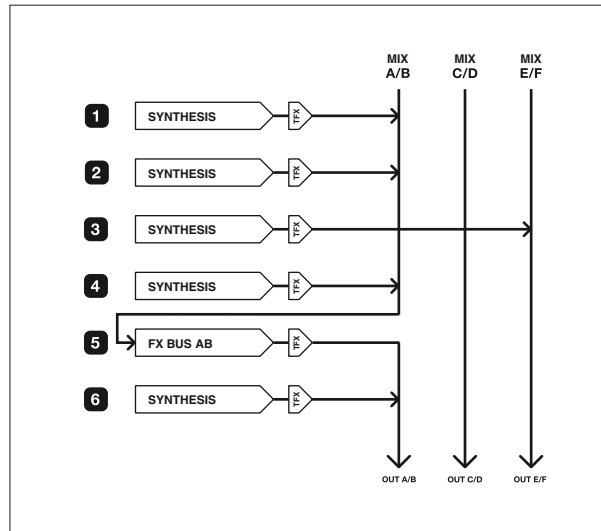

In the example above all tracks but the third is assigned to the AB mix bus. Track 5 is a FX machine, with INPUT and OUTPUT set to MIX AB. As the output is the same as the input the FX is applied as an insert effect. What will happen is that track 1, 2 and 4 will be mixed and effected by track 5. The output of the effect will then be mixed with track 6 and sent to the AB outputs. Track 3 is sent by itself to the EF outputs, non-effected.

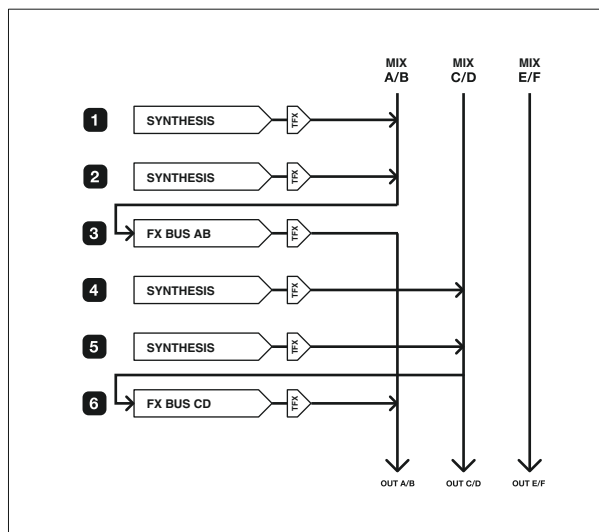

In the example above the two first tracks are sent on the AB bus, and are thus effected by the FX machine on track 3. Track 4 and 5 are sent to the CD mix bus. Track 6 is an FX machine with input taken from the CD Mix bus, which now contains the mixed signal of track 4 and 5. The output of the FX machine on track 6 is set to bus AB with differs from the input CD. Therefore the effected track 4 and 5 is effected and sent to mix bus AB, where they are mixed with the Track 1 and 2 effected by track 3.

#### **ROUTING MODE AB=MIX**

By default the mix buses are sent to the audio outputs with the same names. If you are using only the main AB stereo outputs, or the headphones which carry the same signal, you will not hear what is sent to the CD and EF outputs. By setting the global routing (see section "ROUTING", on page 89) to "3xSTEREO + AB=MIX" the CD and EF buses will be added to the stereo main AB/headphone outputs.

#### **ROUTING MODE 6xMONO**

By setting the global routing (see section "ROUTING", on page 89) to "6xMONO", the AB, CD and EF mix buses will not be sent to the audio outputs. Instead, each of the stereo outputs of the six Monomachine tracks are mixed to mono, and fed to an individual output. The mix buses can still be used, but the final output of them will not be sent to the AB, CD and EF outputs.

Using this mode makes it possible to get the output of each of the Monomachine tracks sent to an individual output, but the stereo effects and panning are lost.

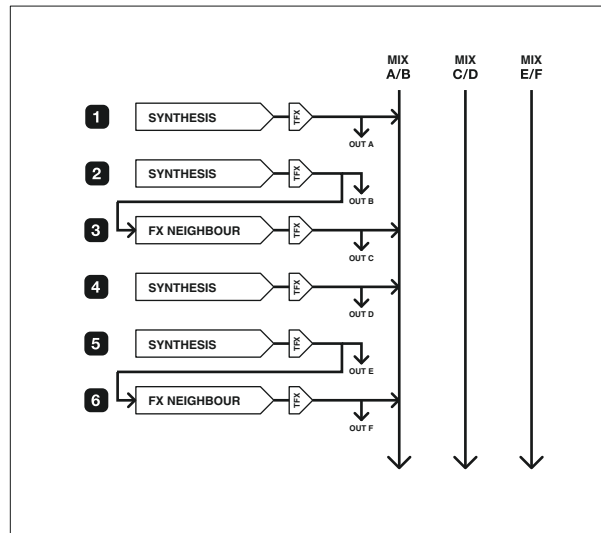

The example above visualises how a global routing configuration of 6xMONO configures the outputs.



- Like all machines, the FX machines need to be triggered before they make any sound. The track effects are active as always, so if you want the sound to go through without decaying you need to set the DEC and REL parameters to their maximum values (127).

## GLOBAL SETTINGS

The Monomachine offers 8 individual slots for storing global settings. The multiple global slots are useful for using the unit in different settings. You can have one setup for studio use and another for the live set, or maybe different setups for different parts of the live set.

The items listed below are available in the GLOBAL menu.

- Turbo menu
- Master tune
- Audio routing options
- MIDI channel setup
- MIDI control settings
- Multi map editor
- Mechanical settings (MKII units only)
- Keyboard velocity response (SFX-6 units only)
- SYSEX send/receive
- DigiPRO waveform manager
- MIDI sequencer settings

1. Press **[FUNCTION]** and then **[PATTERN/SONG]** to open the Global slot selection menu.

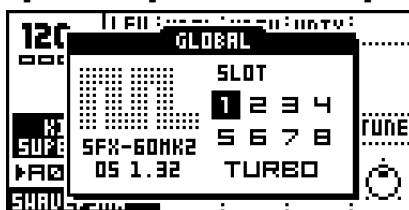

2. Use the **[ARROW]** keys for navigating to the Global slot you wish to use, and press **[ENTER/YES]** to select it. If it was already selected you have now also entered the Global menu for the slot. If not, press **[ENTER/YES]** one more time to enter it.



- It is possible to copy, paste and clear global slots.

## TURBO MENU

The TURBO menu, only available in OS 1.22 and higher, allows you to use the Turbo protocol when connecting the Monomachine to other units that have the Turbo protocol implemented. This will speed up MIDI transfer times considerably, which is handy if you for example want to transfer sysex data or waveforms to another Monomachine.

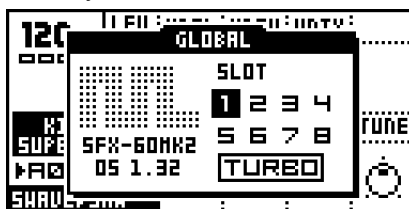

1. Connect the MIDI OUT of your Monomachine to the MIDI IN of the other unit and the MIDI IN of your Monomachine to the MIDI OUT of the other unit.
2. Press **[FUNCTION]** + **[KIT/SONG]** to open up the GLOBAL menu. Use the **[ARROW]** keys to select TURBO. Press **[ENTER/YES]**.



3. CURRENT SPEED shows the current multiplier of the MIDI transfer rate. When not connected to a device using Turbo protocol compatible software, the speed will therefore be x1.0. Select which NEGOTIATE speed you want use. The Monomachine defaults to x10, but this value can be lowered should it be needed. Press the **[ENTER/YES]** button to start to negotiate. The CURRENT SPEED value will display the change of the MIDI transfer rate.



- If you link two Monomachines together where one of them is a MKI model, you might not be able to get a CURRENT SPEED value exceeding 6.7x.

### AUDIO

Here you set the master tune as well as the routing.



### MASTER TUNE

The global master tune can be set in this menu.

1. Select the AUDIO in the GLOBAL menu. Then select MASTER TUNE using the **[ARROW]** keys and press **[ENTER/YES]**.



Use **[UP]/[DOWN]** keys to set the integer part, and **[RIGHT]/[LEFT]** keys to set the fraction. The default value is 440.0 HZ.



## ROUTING

In this menu one of three audio routing selections can be set.

1. Select the AUDIO in the GLOBAL menu. Then select ROUTING using the **[ARROW]** keys and press **[ENTER/YES]**.



Use **[UP]** and **[DOWN]** keys to move the focus, and confirm with **[ENTER/YES]**.

**3xSTEREO** is the default configuration, where the three internal stereo mix buses AB, CD and EF are sent to the audio outputs A/B, C/D and E/F.

**3xSTEREO + AB=MIX**, has the same function as mode 3xSTEREO described above, but the CD and EF buses are mixed also to the A/B outputs, for users only using the A/B main stereo outputs, or headphones.

**6xMONO** mixes the stereo output of each of the six Monomachine tracks to mono. The tracks are then sent directly to each of the audio outputs. Track 1 is sent to output A, Track 2 to output B and so on.

Please see section “MONOMACHINE ROUTING”, on page 81 for detailed information on the Monomachine routing possibilities.

## CONTROL

The Monomachine is designed to fit well into a MIDI environment. It is well equipped for controlling other units using the MIDI sequencer, the MIDI real-time messages (Timing clock, Start, Stop) and Song Pointer Position. It is also ready for a large number of control methods to fit in a wide range of environments. The CONTROL menu is also where you set the resolution of the encoders and the keyboard velocity response of the SFX-6 keyboard.



## MIDI CHANNELS

Here the MIDI channel setup of the Monomachine is found.

Select CONTROL in the GLOBAL menu. Then select MIDI CHANLS using the **[ARROW]** keys and press **[ENTER/YES]**.

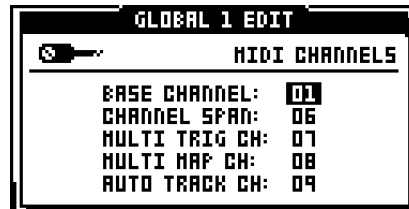

Navigate between the parameters using the **[UP]** and **[DOWN]** keys. Change the parameter values using **[LEFT]** and **[RIGHT]**.

By default the Monomachine responds to 9 MIDI channels. The first six channels directly control each of the six internal monomachine tracks and are called the Individual Track Channels. The MULTI TRIG, MULTI MAP and AUTO TRACK channels follow having specialised functions controlling the Monomachine.

**BASE CHANNEL** (base channel) is the default MIDI channel. Changing this can affect the other channel settings as well.

**CHANNEL SPAN** (channel span) determines the number of MIDI channels used for the individual track channels. The individual track channels are mainly useful if you are using the Monomachine as a sound module. If you use the Monomachine in pattern, song, multi trig or multi map mode, and you do not have the MIDI-channels to spare, you can disable the individual track channels by reducing **CHANNEL SPAN** to zero.

**MULTI TRIG CH** (multi trig channel) directly controls the multi trig monophonic super-synth functionality of the Monomachine. Please see section “MULTI TRIG”, on page 41 for more information. Output data on this channel can only be generated from the keyboard of the SFX-6 when MULTI TRIG Mode is selected.

**MULTI MAP CH** (multi map channel) controls the multi map functionality as described in section “MULTI TRIG”, on page 41. Output data on this channel can only be generated from the keyboard of the SFX-6 when MULTI MAP Mode is selected.

**AUTO TRACK CH** (auto track channel) is a control channel that follow the track selected as active on the Monomachine interface. It is very useful for the tabletop versions of the Monomachine as an external MIDI-keyboard assigned to this channel can function as the keyboard of the SFX-6. It saves the work of switching the channel on the external keyboard when changing track focus of the tabletop versions of the Monomachine. No output data is generated for the auto track channel.

#### **MORE ON THE MONOMACHINE MIDI FUNCTIONALITY**

Some MIDI commands are accepted on all active channels:

- **NRPN data is accepted to control the individual internal tracks**
- **PROGRAM CHANGE can be used for changing pattern**

The NRPN interface doubles with the normal CTRL CHANGE interface of the Individual Track Channels, and provide the same functionality. It is only accepted, never transmitted. See Appendix B for full MIDI specifications of the NRPN interface.

PROGRAM CHANGE can be disabled for MIDI input and output. See section “CONTROL OUT2”, on page 92 for more information.

The Monomachine SFX-6 joystick sends pitch-bend for right and left directions, CTRL CHANGE 1 (mod wheel) for the upward direction and CTRL CHANGE 2 (breath control) for the downward direction. The same messages are accepted by the Monomachine tabletop versions as joystick control.



- **If the individual track channel is disabled you can still control the individual track parameters using the NRPN interface.**

### CONTROL OUT1

This menu contains parameters that control how the Monomachine sends MIDI note and control data.

1. Select the CONTROL in the GLOBAL menu. Then select CONTROL OUT1 using the **[ARROW]** keys and press **[ENTER/YES]**.



Navigate between the parameters using the **[UP]** and **[DOWN]** keys. Change the parameter values using **[LEFT]** and **[RIGHT]**.

**SEQUENCER** controls whether MIDI data of the sequencer should be sent to the internal synthesizer tracks, MIDI OUT or both.

**ARP** controls whether MIDI data of the arpeggiator should be sent to the internal synthesizer tracks, MIDI OUT or both.

**KEYBOARD** controls whether MIDI data of the keyboard and joystick (SFX-6 only) should be sent to the internal synthesizer tracks, MIDI OUT or both. The keyboard on the Monomachine tabletop versions is represented by the **[TRIG]** buttons when not in the GRID RECORDING or LIVE RECORDING modes.

The available selections for all the parameters are:

- **INT** - Only internal control, no external MIDI data will be sent.
- **OUT** - No internal control, only external MIDI data will be sent.
- **INT+OUT** - Internal control, and MIDI data will be sent.



- **Parameter locks of the internal tracks are not transmitted over MIDI, because the data transfer rate of the MIDI standard is too low for delivering large number of control data in time.**

- Note that if internal control is shut off the Monomachine might appear non-functional if MIDI data is not echoed back from an external sequencer.

### CONTROL OUT2

Here parameters dealing with how the Monomachine handles outgoing MIDI sequencer control messages are found.

1. Select the CONTROL in the GLOBAL menu. Then select CONTROL OUT2 using the [ARROW] keys and press [ENTER/YES].

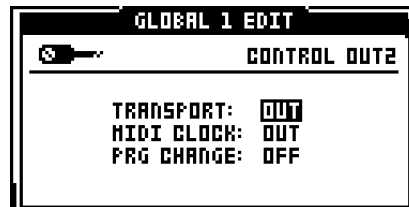

**TRANSPORT** controls whether MIDI Start, Stop and Song Pointer Position are sent.

**MIDI CLOCK** controls whether the Monomachine transmits MIDI clock or not.

**PRG CHANGE** controls on which MIDI channel the Monomachine should send a program change message when patterns are changed. If set to OFF no program change messages will be sent when patterns are changed. When set to BASE, program change messages will be sent on the specified base channel when patterns are changed. Read more on how to set the base channel in section “MIDI CHANNELS” on page 89.

### CONTROL IN

In this menu it is defined how the Monomachine should react to incoming MIDI.

1. Select the CONTROL in the GLOBAL menu. Then select CONTROL IN using the [ARROW] keys and press [ENTER/YES].

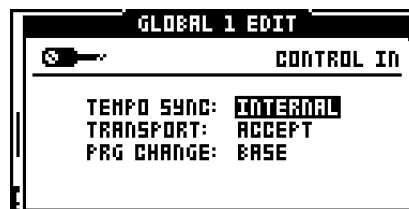

**TEMPO SYNC** defines how the Monomachine should react to incoming MIDI clock. When this parameter is set to EXTERNAL, the Monomachine tempo will be slaved to incoming MIDI time clock. The precision of the timing is limited to the precision of the unit transmitting the MIDI clock signal. When locked to external clock the BPM indicator on the main screen shows “EXT”. If no clock signal is received, the Monomachine will fall back to its internal tempo after a few seconds. When a clock signal is received again the Monomachine will be synced to the external tempo.

**TRANSPORT** controls if the Monomachine should respond to MIDI Start, Stop and Song Pointer Position.

When the Transport parameter is set to ACCEPT, MIDI start, stop and song pointer position messages are recognised.

When the **TRANSPORT** parameter is set to IGNORE, MIDI start, stop and song pointer positions are ignored.

**PRG CHANGE** (program change) controls which MIDI channel the Monomachine should receive program change messages on. When set to IGNORE, incoming program change messages will be disregarded. When set to BASE, program change messages will be received on the base channel plus the channel span channels. Read more on how to set the base channel and the channel span in section “MIDI CHANNELS” on page 89.



- **The Monomachine can transmit a high precision MIDI clock. It is often a good idea to use the Monomachine as master instead of slave, as the timing of other MIDI equipment including many setups with well-known Windows and Mac sequencers is not always reliable.**

### MULTI MAP EDIT

The MULTI MAP EDIT menu provides a fully configurable keymap for triggering patterns.

1. Select the CONTROL in the GLOBAL menu. Then select MULTIMAP EDIT using the **[ARROW]** keys and press **[ENTER/YES]**.

RANGE	PAT	OFS	LEN	TRN	TIM
C-1-E-1	AD1	----		+24	16..
C-2-E-2	AD2	----		+12	16..
C-3-E-3	AD2	00-08		---	DIR
C-4-E-4	AD3	----		---	DIR

Each row represents one range of the keyboard named *keymap range* where one selected pattern will be triggered according to the settings on the row.

Navigate in the keymap using the **[ARROW]** keys. Adjust the settings using the **LEVEL** knob.

**RANGE** is a column where the upper and lower key range limits for the keymap range is controlled. Only the upper range limit can be set. The lower range limit is set one key higher than the previous keymap range upper limit. Adjusting the upper range limit will update the lower range limit for the next range limit. Keymap ranges can be inserted using **[FUNCTION] + [DOWN]** and deleted using **[FUNCTION] + [UP]**. When inserting new keymap ranges there need to be room in the current keymap range. If the range is only one note no new range can be inserted at that position.

**PAT** (pattern) is the column where the patterns which will be triggered for the keymap range are set. The first pattern, called CUR, means the current pattern. If CUR is selected the keymap range settings will be applied to the pattern currently selected when the range is played.

**OFS LEN** (offset and length) is where the playback start and range of a pattern can be adjusted. The **OFS** column can set a start point for the pattern to begin to play and loop. The **LEN** column sets a maximum length of the pattern. Note; the offset need to be set for the **LEN** parameter to be accessible.

**TRN** (transpose) allows the pattern assigned to the keymap range to be transposed.

**TIM** (timing) allows the pattern start to be delayed for the pattern assigned to the keymap range. It has the same function as the timing parameter found in the MULTI TRIG menu (see “MULTI TRIG” on page 41).



- On the SFX-6 you can enter multi map mode by pressing [MULTI TRIG] while holding [FUNCTION]. The multi map mode is indicated by the <MULTI TRIG> LED flashing. The keyboard now trigs patterns as set up in the MULTI MAP EDIT menu.

## MECHANICAL SETTINGS

If you have a MKII unit you can select the resolution of the encoders.

1. Select the CONTROL row in the GLOBAL EDIT menu. Then select MECH SETTINGS and press [ENTER/YES].



**KNOB RESOLUTION** specifies the resolution of the Monomachine encoders. The default resolution setting is 24. Turning an encoder one revolution will cover 24 parameter steps. If you increase the resolution to 32, turning an encoder one revolution will cover 32 parameter steps.

**VELOCITY CURVE** changes the responsivity of the SFX-6 keyboard. There are three settings.

- **LINEAR** is the default setting. The harder you press, the higher the velocity value.
- **SOFT** applies a logarithmic curve to the velocity response. This means you won't have to press the keys especially hard to obtain high velocity values.
- **FIXED** allows you to set a fixed velocity. The velocity will always be the same, no matter how hard you press the keys.

**FIXED VELOCITY** sets the velocity value when **VELOCITY CURVE** is set to FIXED.

**JOYSTICK MAPPING** offers two settings.

- **TIGHT** is the default setting. Not all parameter value combinations can be reached.
- **FULL** makes it possible to reach the all parameter value combinations.

The illustration below exemplifies the relation of joystick position and parameter values. The white area in both illustrations represent the accessible parameter space. The gray area in the illustration of the TIGHT setting represents unaccessible parameter space. The black area in the illustration of the FULL setting shows the joystick positions where the

sound is no longer affected for that particular axis. This is because the maximal parameter value already has been reached.

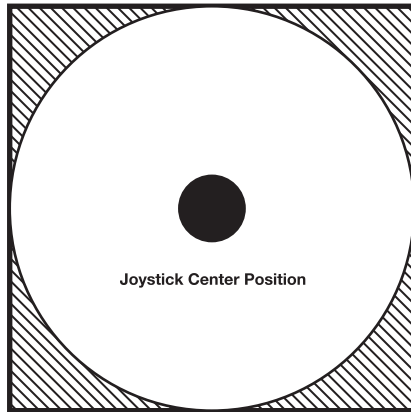

TIGHT



FULL

## FILE

From here you can save and load Monomachine data and settings. You can handle data for patterns, songs, kits and global slots individually or in combinations. You can save the whole memory and restore the state of the unit at a later time. The DIGIPRO MANAGER is also found here. It is used to manage your waveforms.



## SYSEX SEND

This menu is used for sending all or part of the patterns, songs, kits and global slots.

1. Select FILE in the GLOBAL menu. Then select SYSEX SEND using the [ARROW] keys and press [ENTER/YES].

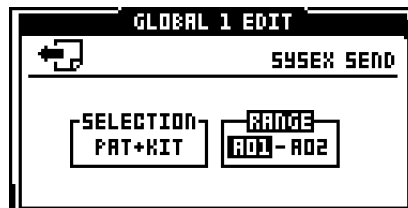

Use the [RIGHT] and [LEFT] keys to move between the tabs. Use the [UP] and [DOWN] keys to change the parameters. The **LEVEL** knob can also be used for setting the ranges.

**SELECTION** offers the following transfer options:

- **ALL** - All Monomachine data (patterns, kits and global data) will be sent. This can be used for making a full backup of all the Monomachine memory data. No **RANGE** parameters are available.

- **KIT** - Only the kits specified in the RANGE tab will be sent.
- **PAT+KIT** - Only the patterns and their associated kits, as selected in the RANGE tab, will be sent.
- **SONG+PAT+KITS** - The songs specified in the RANGE tab, together with their associated patterns and kits, will be sent.

**RANGE** (range) is where the range for the KIT, PAT+KIT and SONG+PAT+KIT transfer methods is set.

To perform a sysex send, follow the instructions below

1. Connect the Monomachine to the device you are sending the data to. See the figure below for an example of what the connections could look like when sending sysex data to a computer.

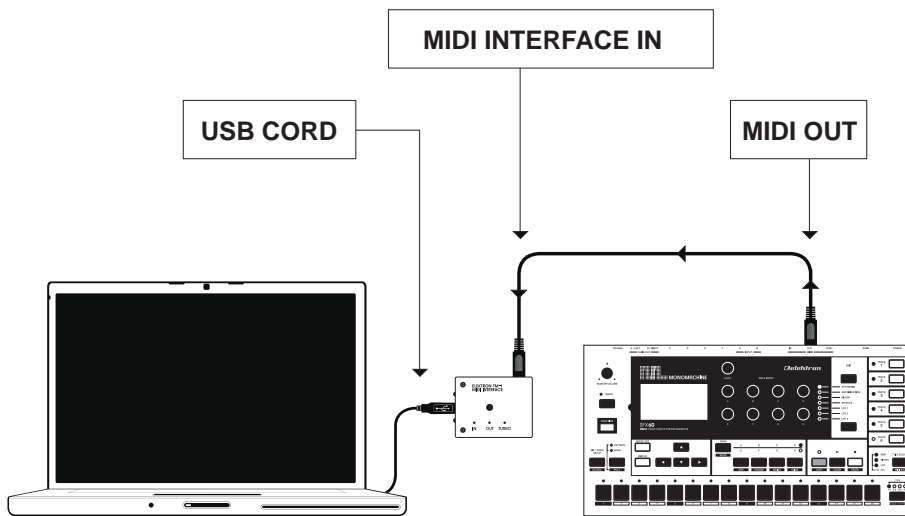

2. Select FILE in the GLOBAL menu. Then select SYSEX SEND using the **[ARROW]** keys and press **[ENTER/YES]**.
3. Select the preferred data send method using the **[UP]** and **[DOWN]** arrow keys.



4. If the selected send method has the option to select a range or a specific number, you can now move the focus to the right. After that, you use **[UP]** and **[DOWN]** or the **LEVEL** knob to select the lower and upper limit of the range. For pattern selection **[BANK A-H]** together with **[TRIG]** buttons can also be used.

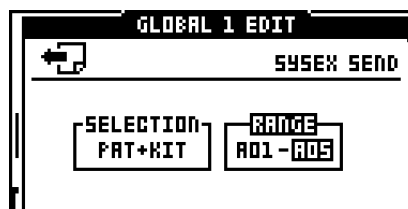



5. Make sure that the device you are sending the data to is ready and waiting.
6. To perform the send, press **[ENTER/YES]**. You will see a sysex message counter on the bottom of the screen indicating how many sysex messages have been sent of the total amount of messages.

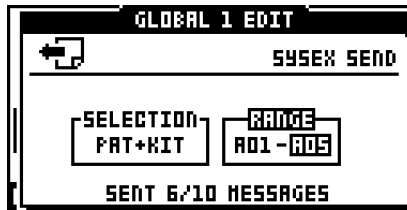

- SYSEX send mode “ALL” may take several minutes to complete, because of the large amount of data transmitted.
- Don’t forget to save the data on the device you recorded it to. At any time during the transfer you can also interrupt the transfer by pressing **[EXIT/NO]**.



- To ensure that your data was received and stored correctly, use the SYSEX VERIFY function found in the SYSEX RECV menu.
- You can always cancel the SYSEX SEND operation by pressing the **[EXIT/NO]** button.
- Use the TM-1 MIDI interface available from Elektron for up to 10x the normal MIDI transfer speed.

### SYSEX RECEIVE

The SYSEX receive function makes it possible to restore previously transmitted data back into the Monomachine.



1. Select FILE in the GLOBAL menu. Then select SYSEX RECV using the **[ARROW]** keys and press **[ENTER/YES]**.



Use the **[RIGHT]** and **[LEFT]** keys to move between the tabs. Use the **[UP]** and **[DOWN]** keys to alter the parameters. The **LEVEL** knob can also be used for setting the ranges.

**MODE** controls how the Monomachine receives incoming sysex data.

- **ORIG** - The kits, patterns, songs and global slot data received will be placed on the original positions they were located at when they were transmitted. Using this method it is not possible to select any start positions in the WRITE POS FROM window.
- **SPEC** - You may specify the positions where you want the kits, patterns, songs and global slots to be stored. Since the Monomachine does not know in advance what kind of, and how much data it will receive, all you can specify is that the data will be placed starting on the positions you specify. If you specify KIT 03 and receive four kits, positions 3 to 6 will be written over no matter where the kits received were originally placed.
- **VERF** - The SYSEX data received is only verified to be correct, it is not stored in memory. Using this method it is not possible to select any start positions in the WRITE POS FROM window.

**WRITE POS FROM** is only available when the SPEC method of recieval is chosen. After selecting SPEC in the MODE tab, enter the WRITE POS FROM tab using the **[RIGHT]** key, then use **[RIGHT]** and **[LEFT]** key to move between the parameters. Adjust the start positions parameters using the **[UP]** and **[DOWN]** keys or the **LEVEL** knob.

To load sysex data into the Monomachine, follow the steps below:

1. Connect the Monomachine to the device you are receiving the data from. See the figure below for an example of what the connections could look like when sending sysex data to a computer.

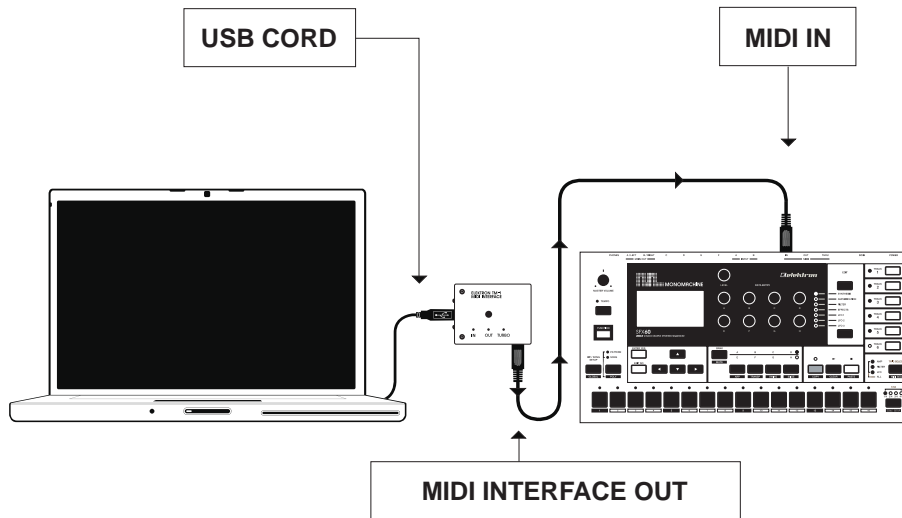

2. Select FILE row in the GLOBAL menu. Then select SYSEX RECV and press **[ENTER/YES]**.
3. Select the receive method you want using the **[UP]** and **[DOWN]** arrow keys. If you have chosen the SPEC option, specify the new start positions for the dump.



- Press **[ENTER/YES]** to start receiving data. A message displaying “WAITING...” shows up in the menu.



- Initiate the data send from the sending device.
- A counter will display how many messages have been received, and, if you have a bad transmission, how many erroneous messages that have been received and ignored.



- Received data will overwrite any previous data in the memory in the positions where it is placed. Make sure you have backed up any important data using SYSEX send.
- Receiving SYSEX data may take a while, depending on the amount of the transmitted data.
- Monomachine only accepts SYSEX data dumps while SYSEX receive is selected and “WAITING...” is displayed on screen.



- Use the TM-1 MIDI interface available from Elektron for up to 10x the normal MIDI transfer speed.

### DIGIPRO MANAGER (MKII UNITS ONLY)

This menu is used to send, receive, erase and rename waveforms. A set of 64 factory waveforms comes preinstalled, but they are replaceable by user waveforms.



When you want to upload your own waveforms there are a couple of things you need to know that will make it easier to obtain musical results. The bitrate and frequency of the audio file you want to use don't matter, the important thing is that you extract one period from it. After extracting one period, you then need to convert the audio file to a DigiPRO syx file. For this task you can for example use our free C6 program, which is found in the support section of the Elektron homepage. Supported formats are wav and aiff. Waveforms are sent and received via MIDI.

1. Select FILE in the GLOBAL menu. Then select DIGIPRO MGR using the **[ARROW]** keys and press **[ENTER/YES]**.



Use the **[UP]** and **[DOWN]** keys to choose the different options in the MODE column. Use the **[RIGHT]** and **[LEFT]** keys to move between the MODE and POS NAME columns.



- A “u” in front of a waveform indicates that it is a waveform uploaded by a user. The factory waveforms don’t have any letter in front of them.
- Move the focus over a waveform to see a graphic representation of it.
- If you have a +Drive equipped Monomachine the currently active Digibank will be displayed under the DigiPro logotype.

### RECEIVE WAVEFORMS

Waveforms can be received either in a specific waveform slot, to consecutive slots or by using the ORG option. The ORG option is handy when you want to transfer several waveforms to specified waveform slots.

To receive waveforms using the ORG method, follow the instructions below.

1. First of all, make sure that the MIDI cables are properly connected. The MIDI OUT of the sending device should be connected to the MIDI IN port of the Monomachine. To send waveforms from a computer you can use our free C6 program, found on the Elektron homepage. If loading a wav or aiff file, don’t forget to convert it to a DigiPRO syx file in C6 before sending it.
2. When in the DIGIPRO MGR, choose RECEIVE and then press the **[RIGHT]** arrow key to move the focus to the POS NAME column. Choose ORG.

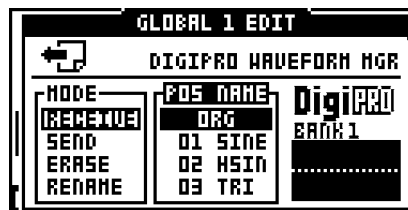

3. Press **[ENTER/YES]** to make the Monomachine ready to receive waveforms. The display will show “WAITING...”
4. Send the waveforms to the Monomachine. A counter on the display will show how many and to which position the waveforms have been received. If the waveforms have previously been dumped from the Monomachine, they will be stored in their former locations.

- When all waveforms have been sent to the Monomachine, press **[EXIT/NO]**. "WRITING WAVEFORMS" will be displayed on the screen. The transfer is now complete.



- If the waveforms sent to the Monomachine are newly made, after being converted to a syx file in C6, they will be stored starting from position 1 when using the ORG method of receipt. The rest of the waveforms will be stored in the following positions in the order they were converted.

To receive a single waveform, or a batch of waveforms, follow the instructions below.

- First of all, make sure that the MIDI cables are properly connected. The MIDI OUT of the sending device should be connected to the MIDI IN port of the Monomachine. To send waveforms from a computer you can use our free C6 program, found on the Elektron homepage. If loading a wav or aiff file, don't forget to convert it to a DigiPRO syx file in C6 before sending it.
- When in the DIGIPRO MGR, choose RECEIVE and then press the **[RIGHT]** arrow key to move the focus to the POS NAME column. Place the focus on the position you want to store the waveform or waveforms by using the **[UP]** and **[DOWN]** keys.

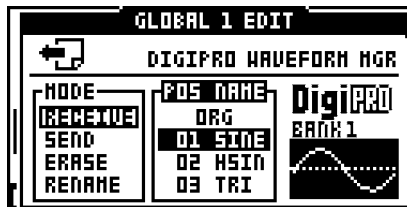

- Press **[ENTER/YES]** to make the Monomachine ready to receive waveforms. The display will show "WAITING..."
- Send the waveform/s to the Monomachine. A counter on the display will show how many and to which position the waveform/s have been received. If you send just one waveform, it will be stored at the chosen position. If you send several waveforms, they will be stored in the order they are sent, starting from the chosen position.
- When all the waveforms have been sent, press **[EXIT/NO]**. "WRITING WAVEFORMS" will be displayed on the screen. The transfer is now complete.

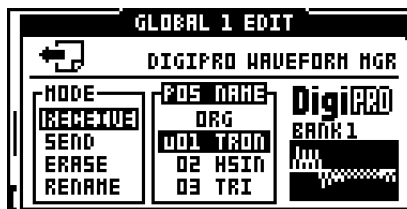



- Note that user waveforms previously stored at the positions you send new waveforms to will be overwritten.



- You can always exit the state where the Monomachine is waiting to receive waveforms. When the screen shows “WAITING...”, just press the [EXIT/NO] key.
- Use the TM-1 MIDI interface available from Elektron for up to 10x the normal MIDI transfer speed.

**SEND WAVEFORMS**

There are two methods of sending waveforms from the Monomachine to a receiving device. One method is called ALL and will send all the user waveforms. You can also send a single user waveform. It is not possible to send factory waveforms.

To send waveforms using the ALL method, follow the instructions below.

1. First of all, make sure that the MIDI cables are properly connected. The MIDI OUT of the Monomachine should be connected to the MIDI IN port of the receiving device. To receive waveforms to a computer you can use our free C6 program, found on the Elektron website.
2. When in the DIGIPRO MANAGER, choose SEND and then press the [RIGHT] arrow key to move the focus to the POS NAME column. Choose ALL.



3. Put the receiving device into a waiting state, ready to receive data.
4. Press [ENTER/YES] to make the Monomachine send all the waveforms. The display will show how many waveforms that have been sent.

To send a single waveform, follow the instructions below.

1. First of all, make sure that the MIDI cables are properly connected. The MIDI OUT of the Monomachine should be connected to the MIDI IN port of the receiving device. To receive waveforms to a computer you can use our free C6 program, found on the Elektron website.
2. When in the DIGIPRO MGR, choose SEND and then press the [RIGHT] arrow key to move the focus to the POS NAME column. Choose the waveform you want to send by pressing the [UP] and [DOWN] keys.



- Put the receiving device into a waiting state, ready to receive data.
- Press **[ENTER/YES]** to make the Monomachine send the waveform. The screen will indicate that a waveform has been sent.



- It is not possible to send factory waveforms. If you try to do so, the message “NOT A USER WAVEFORM” will be displayed on the screen.



- You can always cancel the send operation. When sending, just press the **[EXIT/NO]** key.
- Use the TM-1 MIDI interface available from Elektron for up to 10x the normal MIDI transfer speed.

### ERASE WAVEFORMS

You can erase either all waveforms at once or just a single waveform. When a user waveform is erased, it will be replaced by the factory waveform stored on that particular position. You can not erase the factory waveforms.

To erase all waveforms, follow the instructions below.

- When in the DIGIPRO MGR, choose ERASE and then press the **[RIGHT]** arrow key to move the focus to the POS NAME column. Choose ALL.

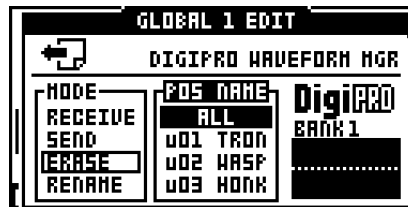

- Press **[ENTER/YES]**. A prompt will appear on the screen as seen below.

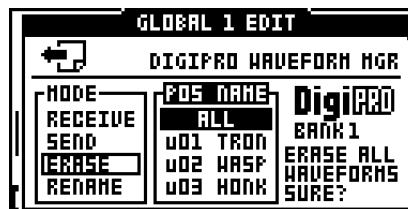

- Press **[ENTER/YES]** to erase all waveforms. To cancel the erase operation, press **[EXIT/NO]**.

To erase a single waveform, follow these instructions:

1. When in the DIGIPRO MGR, choose ERASE and then press the **[RIGHT]** arrow key to move the focus to the POS NAME column. Choose the waveform you want to erase by pressing the **[UP]** and **[DOWN]** keys.



2. Press **[ENTER/YES]**. A prompt will appear on the screen as seen below.

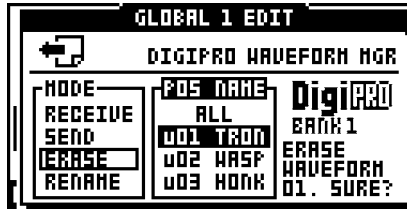

3. Press **[ENTER/YES]** to erase the waveform. To cancel the erase operation, press **[EXIT/NO]**.

### RENAME WAVEFORMS

It is possible to rename the user waveforms. Names can have up to four characters. It is not possible to rename the factory waveforms.

Follow the instructions below to rename a waveform.

1. When in the DIGIPRO MGR, choose RENAME and then press the **[RIGHT]** arrow key to move the focus to the POS NAME column. Choose the waveform you want to rename by pressing the **[UP]** and **[DOWN]** keys.

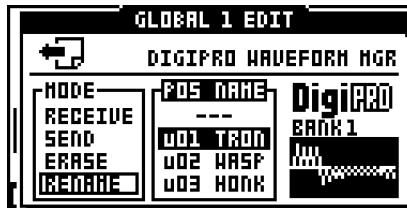

2. Press **[ENTER/YES]**. A window where you will be able to rename the waveform will appear. Use the **LEVEL** knob or the **[UP]** and **[DOWN]** keys to cycle through the letters. The **[LEFT]** and **[RIGHT]** keys move the cursor backwards and forwards on the line.



3. When satisfied with the name, press **[ENTER/YES]** to rename the waveform.





- Pressing the [FUNCTION] while in the WAVEFORM NAME window key gives access to the “high score” selection method, in which you see all characters at the same time. Keep the [FUNCTION] key held while navigating using the [ARROW] keys. Release the [FUNCTION] key, when you have located the letter of your choice.

### +DRIVE SETTINGS (+DRIVE UNITS ONLY)

Here you select how quick loading a new Snapshot will affect the data of the Snapshot currently stored in the Battery Backed Memory. In this menu you can also format your +Drive. Read a brief overview of how +Drive data is handled in relation to the Battery Backed Memory in the section “+DRIVE FEATURES” on page 3.



1. Select the FILE row in the GLOBAL EDIT menu. Then select +DRIVE and press [ENTER/YES].

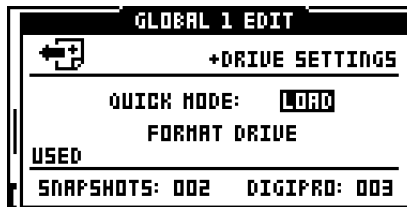

**QUICK MODE** decides the behavior of the QUICK MODE menu. The setting is truly global and will not be changed when changing Snapshots. The QUICK MODE menu allows you to load Snapshots efficiently. Access the QUICK MODE menu by holding down [FUNCTION] while pressing the [KIT/SONG] key. First the GLOBAL menu will be accessed, but after a short while the QUICK MODE menu will appear.

- **CHANGE** will save all pattern, kit, song and global data of the Battery Backed Memory to the Snapshot +Drive location it was loaded from before a new Snapshot is loaded. If this option is chosen, the QUICK MODE menu will be titled CHANGE SNAPSHOT.

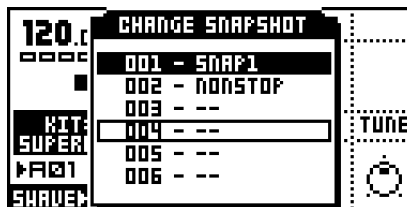

- **LOAD** means that all pattern, kit, song and global data of the Snapshot loaded to the Battery Backed Memory will be overwritten when a new Snapshot is loaded. If this option is chosen, the QUICK MODE menu will be titled LOAD SNAPSHOT.

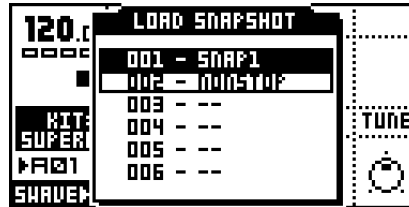

**FORMAT DRIVE** makes it possible to erase everything on the +Drive. If you want to format the +Drive press the **[ENTER/YES]** key. A prompt will appear. Press **[ENTER/YES]** to format the +Drive. Press **[EXIT/NO]** to cancel the operation.



- Note that formatting the +Drive will not erase the Snapshot loaded in the Battery Backed Memory. However, any user waveforms in the Digibank loaded in the DSP will be cleared immediately and replaced with factory waveforms.



- At the bottom of the +DRIVE SETTINGS menu you will see how many Snapshots and Digibanks your unit contains.
- The NEGOTIATE setting in the TURBO menu will just like the QUICK MODE setting stay the same no matter what Snapshot is loaded.

### SNAPSHOT MANAGER (+DRIVE UNITS ONLY)

In this menu you can load, save, rename and erase Snapshots.



1. Select the FILE row in the GLOBAL EDIT menu. Then select SNAPSHOTS and press **[ENTER/YES]**.

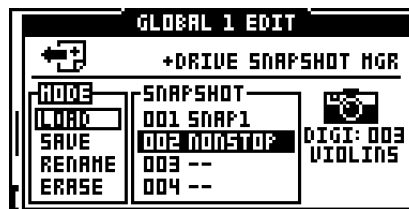

In the MODE column you select which action you want to perform.

**LOAD** will load one of the 128 available Snapshots.

**SAVE** will save the content in the Battery Backed Memory to one of the 128 Snapshot locations.

**RENAME** makes it possible to rename Snapshots. A Snapshot name can contain a maximum of 8 characters.

**ERASE** will erase the selected Snapshot from the +Drive.

**LOCK** will lock the Snapshot. When a Snapshot is locked it is not possible to overwrite, rename or erase it. If **QUICK MODE** in the +DRIVE menu is set to CHANGE the locked Snapshot will disregard this and instead function as if QUICK MODE was set to LOAD. Hence no altered pattern, kit, song, mute settings or global data will be saved when changing Snapshots. A locked Snapshot is indicated by a lock symbol in the lower right side of the menu window.

**UNLOCK** reverts a locked Snapshot to the default, unlocked, status.



- **Copy/Clear/Paste** commands are available in the **SNAPSHOT MANAGER** menu. **Warning! No Undo** command is available in this menu.
- For faster scrolling in the list, hold down the **[FUNCTION]** button and press the **[UP]/[DOWN]** arrow keys.
- To the right, under the camera icon, you can see which Digibank that is linked to the Snapshot. If you switch Digibanks the new Digibank assignment will be graphically updated once the Snapshot is saved. The changes will be reflected immediately in the **DIGIPRO MANAGER** menu though.

#### DIGIBANK MANAGER (MKII +DRIVE UNITS ONLY)

In the DIGIBANK MANAGER menu you can switch, rename and erase Digibanks.



1. Select the FILE row in the GLOBAL EDIT menu. Then select DIGIBANKS and press **[ENTER/YES]**.



In the MODE column you select which action you want to perform.

**SWITCH** allows you to switch to another Digibank.

**RENAME** will rename the selected Digibank. A Digibank name can contain a maximum of 8 characters.

**ERASE** will erase the selected Digibank.

**LOCK** will lock the Digibank. When a Digibank is locked it is not possible to overwrite, rename or erase it. Waveforms in the bank are protected and can't be overwritten or renamed. A locked Digibank is indicated by a lock symbol in the lower right side of the menu window.

**UNLOCK** reverts a locked Digibank to the default, unlocked, status.



- Copy/Clear/Paste commands are available in the DIGIBANK MANAGER menu. Warning! No Undo command is available in this menu.
- For faster scrolling in the Digibank list, hold down the [FUNCTION] button and press the [UP]/[DOWN] arrow keys.
- It's possible to copy DigiPro user waveforms between Digibanks. Open the DIGIPRO MGR in the FILE menu. Select the user waveform you want to copy and press [FUNCTION] + [REC] to copy it. Load a new Digibank. Enter the DIGIPRO MGR, select the position to which you want to paste the user waveform. Press [FUNCTION] + [STOP] to paste the user waveform. No undo function is available here. Factory waveforms are not possible to copy.

### MIDI SEQ

Here relevant settings for the MIDI sequencer are found.



### MIDI SEQ SETTINGS

The MIDI channels and CTRL-change parameters used per channel is set in this menu.

1. Select the MIDI SEQ in the GLOBAL menu. Then select MIDISEQ SET using the [ARROW] keys and press [ENTER/YES].

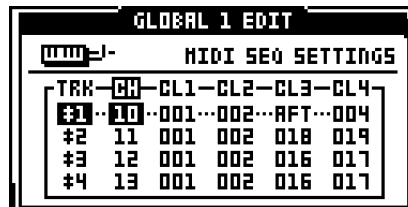

Use the [ARROW] keys for navigating in the window. Use **LEVEL** to update the parameters.

**TRK** (track) is the MIDI sequencer track you are about to edit.

---

## GLOBAL SETTINGS

---

**CH** (MIDI channel) is where you assign on which MIDI channels the six MIDI sequencer tracks send data.

**CL1-4** (control change 1-4) controls which MIDI CC commands that should be available for the MIDI sequencer track. In addition to CC 0-127, after touch ("AFT") can be selected in this column.

---

**EARLY STARTUP MENU**

To access this menu, hold the **[FUNCTION]** key while powering up the Monomachine. From here you can perform a variety of maintenance tasks. To choose the different alternatives, press the corresponding **[TRIG]** key.

```

MM MENU
1..TESTMODE
2..EMPTY RESET
3..FACTORY RESET
4..SOFT RESET
5..MIDI UPGRADE
6..SEND UPGRADE
7..EXIT
  
```

**TEST MODE**

To enter this mode, press the first **[TRIG]** key. If you have any trouble with your Monomachine and suspect it may be due to a hardware problem, perform this self test. Everything should come up as shown below. If not, contact Elektron support.

```

SELF TEST
HOST TEST
  DRAM...OK
  SRAM...OK
DSP TEST
  DSP2...OK
  DSP1...OK
FUNCTION TEST
  
```

Here you can also check that every button and knob work as intended. Press the buttons and turn the knobs and the <TRIG> and <TRACK PAGE> LEDs should light up accordingly. If something does not work as supposed, please contact Elektron Support.

On the SFX-6 the joystick may need calibration. To calibrate the joystick turn it around one lap reaching its extremal points and then press both **[OCTAVE]** keys at the same time. A star appears in the lower right corner of the display indicating that the calibration is done.

**EMPTY RESET**

To perform this operation, press the second **[TRIG]** key. This reset will clear all kits, patterns, songs and global settings. Factory or user waveforms will still be retained in memory.

If you have a +Drive equipped unit all kits, patterns, songs and global settings of the Battery backed memory will be cleared. No DigiPro waveforms will be erased.

**FACTORY RESET**

To perform this operation, press the third **[TRIG]** key. This reset restores all patterns, kits, songs and global settings to the factory presets that was preinstalled when the Monomachine originally shipped. User waveforms are erased and factory waveforms are initialized.

If you have a +Drive equipped unit the Battery Backed Memory will be replaced by factory patterns, kits, songs and global settings. The first Digibank will be replaced with factory waveforms, given you have a MKII version of the Monomachine. The first Snapshot will be

replaced with factory patterns, kits, songs and global settings. No other Snapshots or Digibanks on the +Drive will be affected.

### **SOFT RESET**

To perform this operation, press the fourth **[TRIG]** key. This is a milder form of reset which will retain all data inside your Monomachine.

### **MIDI UPGRADE**

By choosing this option, the Monomachine prepares itself to receive an OS upgrade via MIDI.

1. Check that all MIDI cables are connected correctly.
2. Load the new OS in an appropriate computer program capable of sending sysex files. We recommend the program C6 which can be found on the Elektron website. You can also use another Monomachine with an up to date OS. Connect it to the Monomachine that will be upgraded, and transmit the OS. Read more about this procedure in the "SEND UPGRADE" section.
3. Choose MIDI UPGRADE by pressing the fifth **[TRIG]** key. The Monomachine will wait for an OS to be transmitted to it and a message stating "READY TO RECEIVE MIDI UPGRADE..." will appear on the screen.

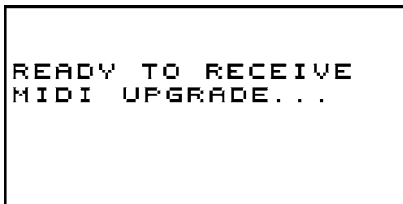

```
READY TO RECEIVE
MIDI UPGRADE...
```

4. Once the Monomachine senses that an OS is being sent to it the <TRIG> LED's will light up one after another. Please note that this procedure takes a while.
5. When the transfer is finished the message "PREPARING FLASH" appears.

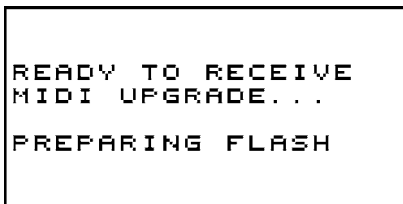

```
READY TO RECEIVE
MIDI UPGRADE...

PREPARING FLASH
```

6. "PREPARING FLASH" is shortly followed by "UPDATING FLASH". When this process is finished the OS is updated.

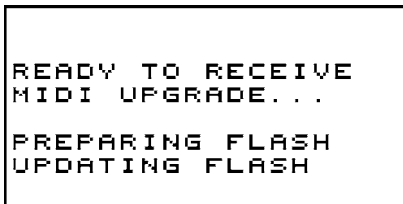

```
READY TO RECEIVE
MIDI UPGRADE...

PREPARING FLASH
UPDATING FLASH
```

### **SEND UPGRADE**

With this option you can send the OS installed in your Monomachine to a another unit.



1. Connect the MIDI OUT on the Monomachine with the latest OS to the MIDI IN on the Monomachine that is going to be upgraded. Enter the EARLY STARTUP menus on both machines.
2. Enter the MIDI UPGRADE mode in the Monomachine that is supposed to be upgraded by pressing the fifth **[TRIG KEY]**. Make sure you see the message “READY TO RECEIVE MIDI UPGRADE...” on the screen.
3. Press the sixth **[TRIG]** key of the Monomachine that is used to send the OS upgrade. This will start the transmission of the OS to the other Monomachine.



- **If you have installed OS 1.07 or above you will experience the speed of the Elektron TurboCharge protocol. You will need to have the MIDI IN port of the receiving machine connected to the MIDI OUT port of the transmitting machine and vice versa for this to function.**



---

TECHNICAL INFORMATION

**SPECIFICATIONS**

**SOUND CONTROL SEQUENCER**

6 internal sequencer tracks.  
6 external MIDI sequencer tracks  
128 x 64 step patterns  
24 songs  
3072 songs (+Drive models only)  
Supports swing, slide and accent  
62 possible parameter locks on each pattern step  
12 multi functional programmable Arpeggiators  
18 tempo synced interlaced LFO's  
Full MIDI support

**SOUND GENERATION SYSTEM**

5 Mono Synths  
14 individual audio generating machines  
4 individual stereo effect machines  
5 effects on each track  
6 part synthesis  
128 kits  
16384 kits (+Drive models only)  
Monomachine SFX-60 MKII only  
64 user waveform slots  
8192 user waveform slots (+Drive models only)

**TRACK EFFECTS**

Tape-style Tempo-synced Delay  
1-Band EQ  
Resonant 24dB lp/bp/hp filter  
Sample rate reduction  
Distortion

**MONO SYNTHS**

SuperWave analogue style synthesis  
SID MOS 6581 computer style synthesis  
DigiPRO digital wavetable and beatbox  
FM+ frequency modulation synthesis  
V0-6 vocal synthesizer

**FX SYNTH**

Reverb, gated stereo plate reverb  
Chorus, stereo 6 tap chorus  
Dynamix, dynamics compressor  
Ring Modulator  
Phaser  
Flanger

**ELECTRICAL SPECIFICATIONS**

Impedance balanced audio outputs:  
Main out level: +15dBu  
Assignable outs level: +10dBu  
Output impedance: 100  $\Omega$  unbalanced  
S/N ratio: 100dBFS (20-20.000Hz)  
Unbalanced audio inputs:  
Input level: +7dBu maximum  
Audio input impedance: 9 k $\Omega$   
SNR inputs: 98dBFS (20-20.000Hz)  
Unit power consumption: 10W typical, 18W maximum.  
Recommended power supply: 6V DC, 3A

**HARDWARE**

128x64 pixel backlit LCD  
MIDI In/Out/Thru  
6 x 1/4" impedance balanced audio out jacks  
2 x 1/4" audio in jacks  
1 x 1/4" stereo headphone jack  
Advanced dual DSP system  
44.1kHz, 24-bit D/A and A/D converters  
Flash-EEPROM upgradable OS  
+Drive (+Drive equipped models only)

**PHYSICAL SPECIFICATIONS**

Steel casing with brushed aluminium panel  
Dimensions: W340xD176xH63mm  
(height including knobs and rubber feet)  
Weight: approximately 2.8 kg

**POWER SUPPLY (PSU-2) ELECTRICAL SPECIFICATIONS**

Input voltage range: 100-240V (43-60Hz)  
Input connector: IEC320-C8 (2 prong)  
In-rush current: 50A maximum  
Output voltage: 5.7-6.3V DC  
Output current: 3.5A maximum  
Output connector: 5.5x2.5mm DC plug, power at center



---

## DIFFERENCES BETWEEN THE MKI AND MKII MODELS

There exist a number of hardware differences between the MKI and MKII models of the Monomachine. Below is a compilation of the most important differences.

### DESIGN

The height of the the MKII models are 63mm including rubber feet and knobs.

The height of a SFX-6/60 MKI unit including rubber feet and knobs is 77mm.

The SFX-6 measures 975x176x77mm including knobs and rubber feet and includes a full size 3 octave keyboard and a joystick.

### POWER SUPPLY

A switched-mode power supply is used for the MKII models which allow the units to be used all over the globe without the need of voltage converters. The SFX-60 MKI models use an AC power supply.

The output specification of the SFX-60 MKI power supply is: 6 Volts AC, 2800mA, 50/60Hz. The plug size of the SFX-60 MKI supply is the same as a MKII power supply.

The SFX-6 has an IEC 60320 C14 3-prong inlet to connect to a grounded main power supply using either using 115V or 230V (please see “ADDITIONAL REAR CONNECTORS, SFX-6” on page 8 for further details)

### SNR RATIO AND OUTPUTS

The S/N of the outputs on the Monomachine MKII is 100dB. The outputs of the MKII units are also impedance balanced.

The S/N for a MKI unit outputs is 91dB and the outputs are unbalanced.

### USER WAVEFORMS

The Monomachine MKII has the capability of hosting user waveforms.

---

## CREDITS

---

---

## CREDITS

### PRODUCT DESIGN AND DEVELOPMENT

Anders Andersson  
Magnus Forsell  
Anders Gärder  
Daniel Hansson  
Jimmy Myhrman  
David Möllerstedt  
Danjel Rydén  
Henrik Sallander  
Fredrik Åhfeldt

### INDUSTRIAL DESIGN

Thomas Ekelund  
Jesper Kouthoofd

### ADDITIONAL DESIGN

Göran Finnberg  
Charlie Storm

### USER'S MANUAL

Thomas Ekelund  
Daniel Hansson  
Jon Mårtensson

### FACTORY DEFAULT SOUND DESIGN

Pattern A01-A15  
Pattern B03-B06  
Pattern B08-B16  
Pattern C03-C16

by Daniel Troberg

Pattern A16  
Pattern B01-B02  
Pattern B07  
Pattern C01-C02

by Nils Odegaard

### FACTORY WAVEFORMS

Charlie Storm  
Daniel Troberg



---

**CONTACT INFORMATION**

**ELEKTRON WEBSITE**

<http://www.elektron.se>

**POSTAL ADDRESS**

Elektron Music Machines MAV AB  
Sockerbruket 9  
SE-414 51 Gothenburg  
Sweden

**TELEPHONE**

+46 (0)31 743 744 0

# Appendix A: MACHINE REFERENCE

In this section all the Mono-synths of the Monomachine are introduced, including specifications for individual machines.



## SUPERWAVE

SuperWave takes its inspiration from the analogue world. It gives warm and thick sounds made from unique algorithms. The Ensemble is specialised in creating polyphonic textures, chords and harmonies.

### SUPERWAVE SAW “SWAVE-SAW”

The SuperWave Saw machine offers eight analogue style oscillators, organised to bring thick sounds with relevant controls.

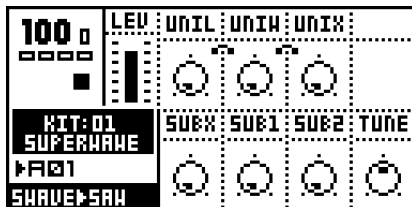

The core of the sound is made up from one base sawtooth oscillator. Setting all parameters to their lowest value leaves only the base sawtooth.

### SUPERWAVE SAW ILLUSTRATION

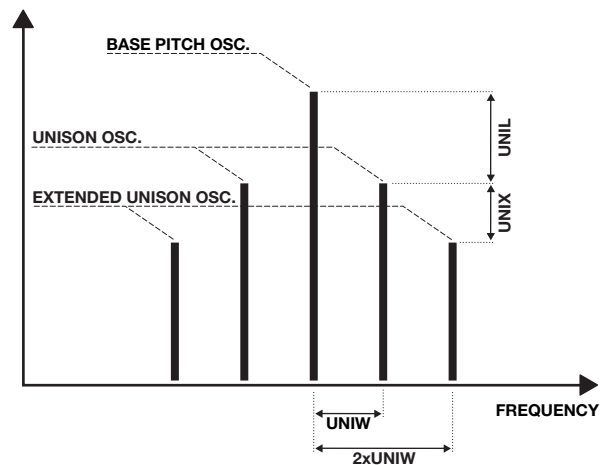

**UNIL** (unison level) controls the level for the *unison oscillator* pair of sawtooth oscillators, located over and under the base pitch.

**UNIW** (unison width) sets the distance between the unison oscillators and the base pitch.

**UNIX** (unison extended level) controls the level of the two additional *unison extended oscillators* (sawtooth). They are located over and under the base pitch, at double the **UNIW** distance. **UNIX** is limited by the **UNIL**, so to get any effect from the **UNIX**, **UNIL** has to be increased first.

**SUBX** controls a square wave suboscillator, located one octave below the base pitch.

**SUB1** controls a sine sub oscillator, located one octave below the base pitch.

**SUB2** controls a sine sub oscillator, located two octaves below the base pitch.

**TUNE** (tune) sets the tune of the oscillator.

### SUPERWAVE PULSE “SWAVE-PULSE”

The SuperWave Pulse machine offers five analogue style oscillators, three of which offer Pulse Width Modulation.

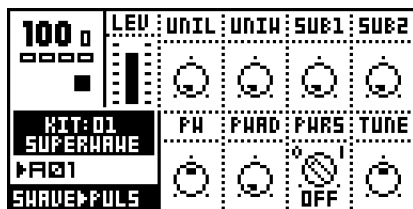

The core of the sound is made up from one base pulse oscillator.

**UNIL** (unison level) controls the *unison oscillator* pair of pulse oscillators, located over and under the base pitch.

**UNIW** (unison width) sets the distance between the unison oscillators and the base pitch.

**SUB1** controls a sine sub oscillator, located one octave below the base pitch.

**SUB2** controls a sine sub oscillator, located two octaves below the base pitch.

**PW** (pulse width) controls the pulse width of the base oscillator and the two unison oscillators. The center value (0) of the gives a square form, and the higher and lower settings turn the waveform towards a spike form.

**PWAD** (pulse width add) controls the sweep between the square and spike forms of the **PW** parameter. Setting **PWAD** to zero turns off the pulse sweep. The pulse sweep speed increases with higher settings of **PWAD**.

**PWRS** (pulse width restart) will when activated restart the pulse sweep controlled by

the **PWAD** parameter from the **PW** position each time a note is played.

**TUNE** (tune) sets the tune of the oscillator.

### SUPERWAVE ENSEMBLE “SWAVE-ENS”

The SuperWave Ensemble machine offers up to eight analogue style oscillators, set up with special controls to create up to four note chords with only one machine.

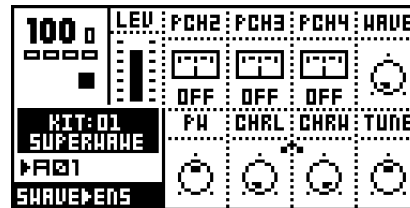

The Ensemble machine generates one single oscillator, single pitch sound with the default settings.

**PCH2-4** (pitch 2-4) adds an oscillator offset from the base pitch. If C-4 is played and **PCH2** = 4, **PCH3** = 7, **PCH4** = OFF, the notes C-4, E-4 and G-4 will sound.

The pitches can also be set to the exact octave intervals 6/5, 5/4, 4/3 and 3/2 for creating just intonated (cleaner sounding) chords. To change chord inside a pattern, use parameter locks!

**WAVE** (waveform) controls the oscillator shape. The ensemble waveforms are constructed from two saw tooth oscillators, which can unite to create a set of waveforms ranging from saw tooth through square to spikes. Adjusting **PW** will mutate the sound, giving various results depending on the **WAVE** settings.

**PW** (pulse width) mutates the sound, giving various results depending on the **WAVE** settings. Its center value (0) will take the **WAVE** from a saw wave to a square wave.

**CHRL** (chorus level) controls the chorus level of the ensemble chorus.

**CHRW** (chorus width) controls the width of the ensemble chorus.

**TUNE** (tune) sets the tune of the oscillator(s).



## SID

The Mono-synth SID is based on the synthesis of the legendary SID chip, found in the Commodore 64. The SID-chip was used in the first Elektron synthesizer, the SidStation.

### SID 6581

The SID 6581 machine offers one oscillator of high quality MOS 6581 synthesis, complete with ringmod and sync. Just like the original the oscillators are derived from an extremely fast main counter, giving a crisp and highly recognisable sound.

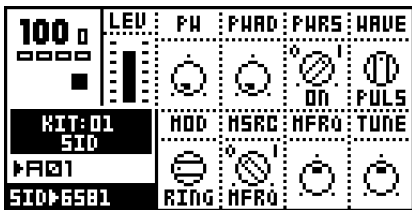

**PW** (pulse width) controls the sound of the PULSE waveform, and to some degree also the MIXED waveform.

**PWAD** (pulse width add) sets the depth of the pulse sweep. When set to 0 no pulse sweep will be added to the waveform.

**PWRS** (pulse width restart) will when activated restart the pulse sweep controlled by the **PWAD** parameter from the **PW** position each time a note-on is played.

**WAVE** (waveform) selects the basic waveform to be used. The available waveforms are:

- TRI - TRIANGLE
- SAW - SAW TOOTH
- PULS - PULSE
- MIX - MIXED
- NOIS - NOISE

Waveforms differing to the standard definitions are MIXED, which is a special digital SID waveform, and NOISE, which gives different sound depending on the pitch it is played with.

**MOD** (modulation) controls the type of modulation to be used. The available selections are:

- OFF - No modulation
- RING - Ring Modulation
- SYNC - Hard Sync
- R+S - Ring Modulation and Hard Sync

**MSRC** (modulation source) controls from where the second frequency is taken. All of the modulation options need a second frequency for their operation.

The first selection is MFRQ, which directs the SID to take the modulation frequency from the **MFRQ** parameter.

The second selection is PRCH. PRCH stands for previous channel, which directs the SID to look at the frequency played at the track one index less than the one it is placed on. If MSRC is set to PRCH for track 2 the SID will take its modulation frequency from the pitch played on track 1. This allows two tracks to simultaneously influence the SID sound.

**MFRQ** (modulation frequency) sets the modulation frequency if the **MSRC** parameter is set to MFRQ

**TUNE** (tune) sets the tune of the oscillator.

# DigiPRO

## DIGIPRO

DigiPRO offers raw digital waveforms, which can be put into animated life. Apart from the fixed waveforms, user waveforms can be used in the two special DigiPRO machines DPRO-DDRW and DPRO-DENS. These two machines are exclusive for the Monoma-chine MKII models. The BeatBox, which also is a part of DigiPRO, offers a percussive toolbox shaped in the traditions of the Machine-drum E12 synth.

### DIGIPRO WAVE “DPRO-WAVE”

DigiPRO WAVE is a crunchy waveform based synthesizer, proud of its digital heritage. The sounds are harsh and electrical and stand out in the mix. Often it comes to its best when tamed with a filter.

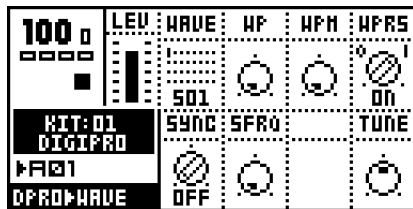

**WAVE** (waveform) selects from the 32 original 512-sample 12-bit waveforms.

**WP** (wave phase) is a parameter that can transform the waveform currently selected to the next one. The 128 steps between can offer a wealth of new sounds.

**WPM** (wave phase modulation) offers the possibility of a continuous sweep over the wave phase range. When value of WPM is 0 the sweep is turned off. Higher WPM settings increase the speed of the wave phase sweep.

**WPRS** (wave phase restart) will when activated restart the wave phase sweep controlled by the **WPM** parameter from the **WP** position each time a note-on is played.

**SYNC** (hard sync) offers the following selections:

- OFF - Hard Sync is turned off
- SFRQ - Hard Sync is active, frequency from SFRQ
- PRCH - H. Sync is active, frq from previous channel

If **SYNC** is set to SFRQ, the source frequency is taken from the **SFRQ** parameter. If it is set to PRCH, short for previous channel, the source frequency is taken from the track places before the current track.

**SFRQ** (source frequency) set the frequency that will modulate the **SYNC**, if set to SFRQ.

**TUNE** (tune) sets the tune of the oscillator.

### DIGIPRO BEAT BOX “DPRO-BBOX”

The DigiPRO BeatBox offers a percussive toolbox, with carefully processed 12-bit samples. Unlike the other machines, different sounds are generated depending on which key is played.

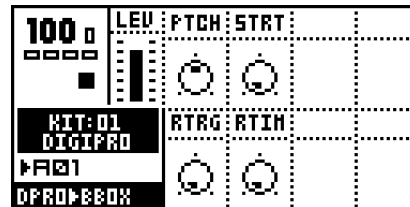

All parameters control all the percussive sounds simultaneously. If you want different settings for different steps of a pattern, use parameter locks.

**PTCH** (pitch) controls the general coarse pitch.

**START** (sample start position) adjusts the position where to start playing the sample. This can be used to avoid sharp transients at the beginning of the samples. Setting **START** to 127 makes the sample start playing at half the sample length.

**RTRG** (retrig) sets how many times the sample will restart. Setting the parameter to zero disables the the function, and setting Retrig to 127 gives infinite retrigs.

**RTIM** (retrig timing) sets the time between the retrigs. If **RTIM** is set low the retrigs will create a pitch, allowing the BeatBox sounds to be used as base for melodic sounds.



A total of 24 percussive sounds are available in the BeatBox. The sounds fill two octaves starting at C-3 and are repeated for the octaves above and under with adjusted pitch.

C-3 - Bass Drum 1	C-4 - Bass Drum 2
C#3 - Snare Drum 1	C#4 - Snare Drum 2
D-3 - Tom 1	D-4 - Timbale
D#3 - Tom 2	D#4 - Aggobell
E-3 - Bongo Congo	E-4 - Timpani
F-3 - Clap	F-4 - Snap
F#3 - Rim Shot	F#4 - Wood
G-3 - Cow Bell	G-4 - Triangle
G#3 - Closed HiHat	G#4 - Shaker
A-3 - Open HiHat	A-4 - Maracas
A#3 - Ride Cymbal	A#4 - Whistle
B-3 - Crash Cymbal	B-4 - Blipp

### DIGIPRO DOUBLEDRAW “DPRO-DDRW”

The DigiPRO Doubledraw machine makes it possible to make an oscillator out of two waveforms. This machine is only available in Monomachine MKII models.

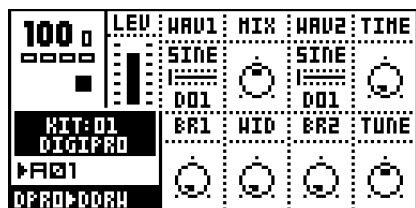

**WAV1** (waveform 1) sets which of the 64 possible waveforms that should be used for the first waveform slot. The uppermost dotted line indicates which of the 8 waveform banks that currently is selected. The lower dotted line shows the chosen waveform in the selected bank.

**MIX** (mix) adjusts the volume balance between the two waveforms.

**WAV2** (waveform 2) sets which of the 64 possible waveforms that should be used for the second waveform slot. The uppermost dotted line indicates which of the 8 waveform banks that currently is selected. The lower dotted line shows the chosen waveform in the selected bank.

**TIME** (glide time) sets the interpolation time when a waveform is changed. If set to 0 the waveform change will be instant. The higher the value, the slower the interpolation will be.

**BR1** (bit reduction 1) sets the bit reduction for **WAV1**.

**WID** (width) sets the pitch distance between the waveforms.

**BR2** (bit reduction 2) sets the bit reduction for **WAV2**.

**TUNE** (tune) sets the tune of the oscillator.

### DIGIPRO ENSEMBLE “DPRO-DENS”

The DigiPRO Ensemble allow chords to be made out of a single waveform. This machine is only available in Monomachine MKII models.

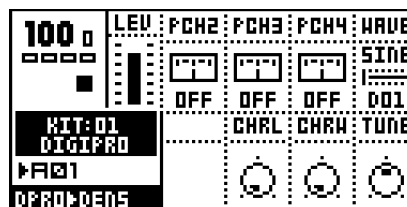

**PCH2-4** (pitch 2-4) adds an oscillator offset from the base pitch. If C-4 is played and **PCH2 = 4**, **PCH3 = 7**, **PCH4 = OFF**, the notes C-4, E-4 and G-4 will sound.

The pitches can also be set to the exact octave intervals 6/5, 5/4, 4/3 and 3/2 for creating just intonated (cleaner sounding) chords. To change chord inside a pattern, use parameter locks!

**WAVE** (waveform) selects the waveform that should be used for the machine.

**CHRL** (chorus level) controls the chorus level of the Ensemble chorus.

**CHRW** (chorus width) controls the width of the Ensemble chorus.

**TUNE** (tune) sets the tune of the oscillator(s).

# FM+

## FM+

FM+ is 21st century FM synthesis. It implements world class frequency modulation algorithms that address the complexity problem normally associated with FM.

All three FM+ machines are based around a number of custom made FM blocks. The machines have then been handcrafted, each with its own personality.

It is not necessary to understand the detailed machine descriptions of the FM+ machines. Good results should be possible to attain only by trying out the effects of the parameters and get a good “feeling” for them.

All the FM+ machines use a special combined amplitude and envelop controller. This is visualised by the figure below:

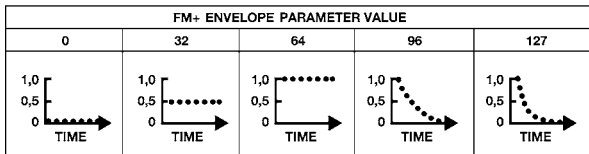

## FM+STATIC “FM+STAT”

FM+STATIC is the most versatile of the FM+ machines, and the best bet for successful FM synthesis.

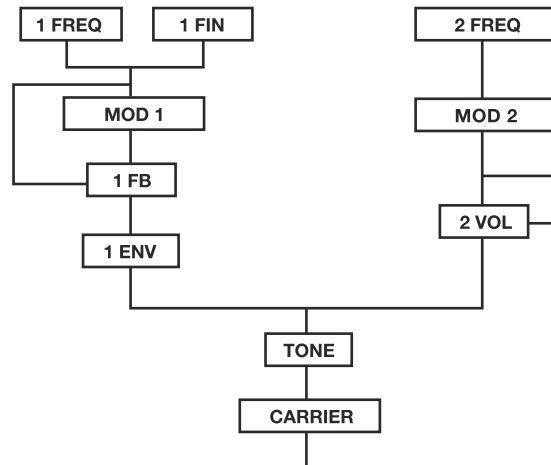
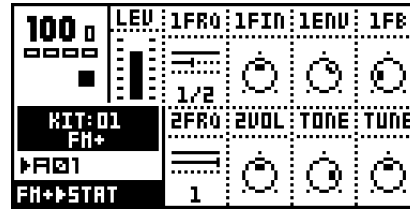

**1FRQ** (modulator 1 listed frequency) offers both fine and coarse frequency tuning. The parameter controls the coarse frequency from a choice of listed frequencies, selected for yielding good results for FM synthesis.

**1FIN** (modulator 1 frequency fine tune) controls the fine frequency tuning for precise adjustments.

**1FB** (modulator 1 feedback) controls the modulator 1 feedback.

**1ENV** (modulator 1 volume & envelope) controls the final output volume of the first FM block, as described by the FM+ Envelope figure.

**2FRQ** (modulator 2 listed frequency) controls the second modulator by the listed frequencies.

**2VOL** (modulator 2 volume & feedback) controls the final output volume of the second FM block. For high **2VOL** settings amplitude feedback is introduced to emphasize the effect on the carrier.

**TONE** (tone) is a general controller for the FM frequencies generated in the system. High settings introduce more high frequency harmonic contents.

**TUNE** (tune) sets the tune of the output.

### FM+PARALLELL “FM+PAR”

FM+PARALLELL is the bombastic FM+ machine. It brings three exact copies of the most efficient FM+ structure.

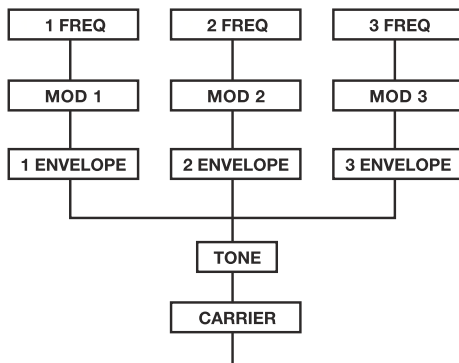
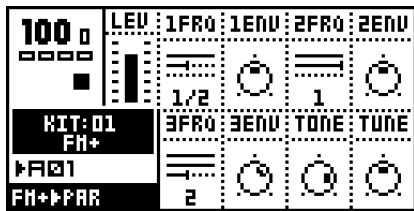

**1-3FRQ** (modulator 1-3 listed frequency) sets the listed frequencies for **Modulator 1-3**.

**1-3ENV** (modulator 1-3 volume & envelope) controls the final output volume of the FM blocks, as described by the FM+ Envelope Figure.

**TONE** (tone) is a general controller for the FM frequencies generated in the system. High settings introduce more high frequency harmonic contents.

**TUNE** (tune) sets the tune of the output.

### FM+DYNAMIC “FM+DYN”

FM+DYNAMIC is the wildest of the FM+ machines, where the frequencies are set continuously instead of using the listed frequency.

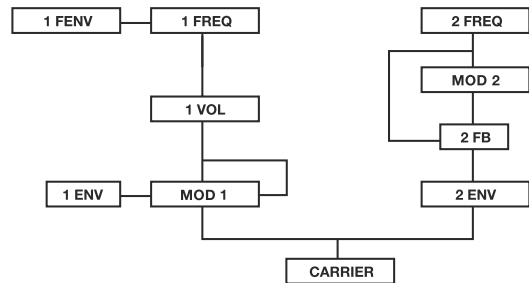
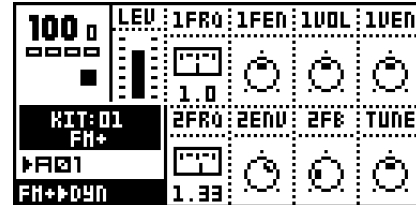

**1FRQ** (modulator 1 linear frequency) sets the linear continuous frequency control of modulator 1.

**1FEN** (modulator 1 frequency envelope) controls the speed and depth of the exponential envelope. The envelope is triggered for all note-on's played and is added to **1FRQ**.

**1VOL** (modulator 1 volume & feedback) controls the final output volume of the first FM block. For high **1VOL** settings amplitude feedback is introduced to emphasize the effect on the carrier.

**1VEN** (modulator 1 volume envelope) controls the speed and depth of the exponential envelope. It is triggered for all note-ons played and is added to the output volume block of modulator 1.

**2FRQ** (modulator 2 exponential frequency) sets the exponential continuous frequency control of modulator 2.

**2ENV** (modulator 2 volume & envelope) controls the final output volume of the second FM block.

**2FB** (modulator 2 feedback) controls the modulator 2 feedback.

**TUNE** (tune) sets the tune of the output.

# VO

## VO

VO is inspired by classic voice modelling methods using formant synthesis. The goal has not been to recreate any existing voice or speech synthesizer, but to create a new way of building and controlling a synthetic voice in a way that suits musicians.

### VO-6

VO-6 is the VO incarnation in the Monomachine. It is based around a voicing source, gradually controllable between pulse or white noise, formant filters and a set of internal envelopes which combines to create a pre-defined set of consonants and consonant-like sounds.

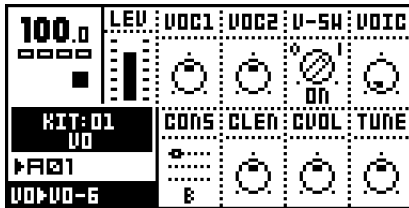

A trig of VO-6 consists of a consonant and a vowel. It starts with the selected consonant, if any.

**VOC1-2** (vocal frequency1-2) control the vocal Frequency formant parameters. All vowels can be reproduced in the ranges of these two parameters.

**V-SW** (vowel switch) controls whether the vowel sounds should be turned off or not. This is good for ending words that end on consonants. If no consonant is selected the vowel will be played regardless of the **V-SW** setting.

**VOIC** (voice type) adjusts the voice type from normal to whispering.

**CONS** (consonant) controls if the note trig should start with a consonant, or a consonant-like sound. If "-" is selected the sound starts directly with a vowel.

**CLEN** (consonant length) controls how long the selected consonant will be pronounced.

**CVOL** (consonant volume) controls the volume of the consonant. Using this parameter it is possible to change the dynamics of the speech, for instance making the programmed words sound more or less emotional.

Not all consonants are affected by the **CLEN** and the **CVOL** parameters; see the table below for reference on which consonants are affected.

CONS	CLEN	CVOL
- (NONE)	-	-
B	-	-
D	-	x
F	x	x
G	-	x
H	x	x
J	x	-
K	-	x
L	x	-
M	x	-
N	x	-
P	-	x
R	x	-
RR	x	-
S	x	x
SJ	x	x
T	-	x
TJ	x	x
TH	x	x
V	x	-
Z	x	x

**TUNE** (tune) sets the tune of the output.

---

## VO-6 TUTORIAL

Getting words out of the VO-6 is pretty straight forward once you get to know it. In this section we offer a short tutorial to get you started. It will make a Monomachine track fitted with the VO-6 spell out the word "Monomachine".

Start with loading the VO-6 machine on one of the Monomachine tracks, and verify that it makes sound as you play it on the keyboard. Be sure to start with a clear pattern, set the tempo to 120 and make sure that the **V-SW** parameter in the VO page is set to 1 (on).

You then need to adjust the amplitude envelope to make the VO-6 respond the way we want. Set **ATK** = 0, **DEC** = 127 and **REL** = 0. The VO-6 now responds quickly, holds for as long as the note is held, and quiets quickly when we let the note go.

Now we can start with the actual programming. Our method will be to work in four steps for each syllable of the word:

1. Find the right vowel by turning the **VOC1** and **VOC2** knobs while playing on the keyboard.
2. Choose the right consonant with the **CONS** parameter and adjust its sound with the **CLEN** and **CVOL** parameters. Remember that when you look for the correct consonant you should seek a consonant that makes the sound you want rather than how the word is spelled. For example, if you want to say "cat" you should start with a "k".
3. Enter GRID RECORDING mode. Put a trig on the step where you want it.
4. Press and hold this trig and push each knob you used in step 1 and 2 to lock the parameters. You might want to lock the **VOC1**, **VOC2**, **CONS** and **CLEN** parameters.

To program the VO-6 to spell out "Monomachine" we need to set 5 trigs with the sounds "mo"+"no"+"ma"+"shi"+"n". You will find the right vowel for "mo" by setting **VOC1** = 35 and **VOC2** = 5. Trig the machine and it should say "o".

Now select "M" with the **CONS** knob, and set **CLEN** to 5. Now it is time to set the first trig.

In GRID RECORDING mode, set a trig on step 1. Hold it while clicking the knobs for **VOC1**, **VOC2**, **CONS** and **CLEN**, so that these parameters get locked. Also adjust the pitch of this trig by pressing **[LEFT]** and **[RIGHT]** while holding the trig. Choose pitch "F-2". Now we are ready with the first trig, time to set the second one.

Make sure the **VOC1** and **VOC2** knobs are still in the same position as for the first trig, as the vowel for "no" is the same as for "mo". Turn the **CONS** knob to "N", set **CLEN**=5. Set this trig on step number 4. Press and hold it and push the **VOC1**, **VOC2**, **CONS** and **CLEN** knobs to lock them.

To make a more natural sound, set a note-off trig on step 6 by pressing the **[TRIG]** key while holding **[FUNCTION]**.

For the third trig we want to say "ma". Set **VOC1** = 127, **VOC2** = 60, **CONS** = "M" and **CLEN** = 5. Set a trig on step 7 and lock the parameters mentioned above.

The fourth trig should say "shi". Adjust the parameters to **VOC1** = 40, **VOC2** = 110, **CONS** = "SJ" and **CLEN** = 0. Set a trig on step number 10 and lock the parameters mentioned above.

If you press play now, the pattern should say "monomachiiii". The last thing we need to do is to end the track with an "n". Make sure that **VOC1** and **VOC2** retain the settings from last trig. Set **CONS**="N". Set a trig on step number 13, and lock **VOC1**, **VOC2**, **CONS** and **CLEN**. This time we also want to lock the **V-SW** knob to 0 in order to make it say "n" and then stop. Do this by holding the trig while turning the **V-SW** to 0.

Now press play and the Monomachine should spell out "monomachine" when you press play.

You can continue exploring the possibilities by adjusting the filter, adjust the sample rate reduction or other effects you might think of. You can lock the effects on individual steps to get different effects for the syllables. Use MULTI TRIG mode to control the pitch of the words in real-time.

## GND MACHINES

The GND synthesis consists of three machines with very basic functionality. They can be used for adding extra tonality to other sounds.

### GROUND “GND”

The GND machine consists of basically nothing at all.

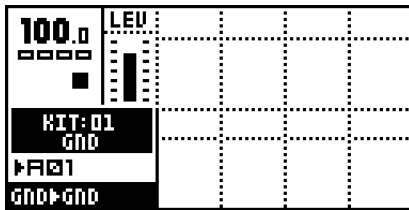

### SINE WAVE “SIN”

This machine generates a basic sine wave. When a machine is cleared, it reverts into a SIN machine.

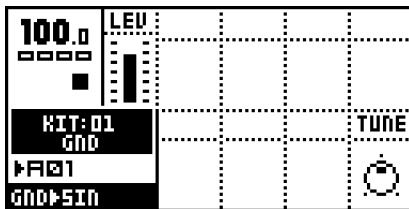

**TUNE** (tune) sets the tune of the oscillator.

### NOISE “NOIS”

Generates different colors of noise.

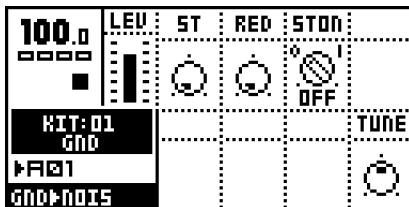

**ST** (stereo) changes the character of the noise waveform. If **STON** is set to ON, increasing the **ST** parameter will expand the stereo width of the noise waveform.

**RED** (redness) sets the color of the noise. When set to zero the noise is white, when set to 64 pink noise is generated. Red noise is generated when the parameter is set to its max value.

**STON** (stereo on) activates the stereo width functionality of the **ST** parameter.

**TUNE** (tune) sets the tune of the oscillator.



## FX MACHINES

The FX machine group differs from the other machines of the Monomachine in that they do not generate any sound by themselves. They need to be supplied with an audio signal from another source, either internal Monomachine audio, or external audio fed into the Audio inputs. Please refer to section , “USING THE AUDIO INPUTS,” on page 82 for instruction on how to configure the audio input of the FX machines.

Don’t forget that also the FX machines need to be triggered to make any sound, and that their output is fed through the track effects, of which the amplification envelope is a part. If you want to let the sound pass through without decaying you should set **ATK** = 0, **DEC** = 127 and **REL** = 127 and retrigger the machine.

## THRU

The through machine does not process the audio other than through a signal amplifier, to let you adjust the audio level. It is a good starting point for processing external audio and let it pass through the track effects.

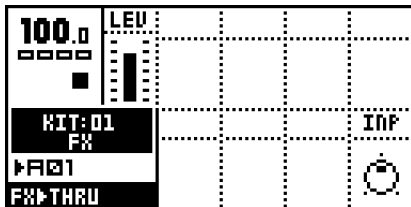

**INP** (input signal amplification) can be adjusted to determine the signal input. Remember you can use the amplitude envelope and the rest of the track effects, together with the sequencer if you prefer.

## REVERB

The reverb machine is a specially designed version of the Elektron Gate reverb. It offers a characteristic gated reverb known from the Machinedrum.

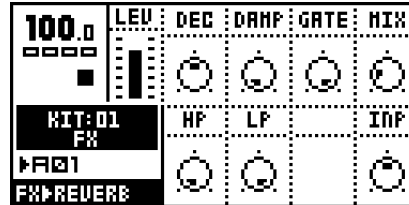

**DEC** (decay) controls the decay time, i.e. how long time the reverberated signal will stay around before dying out.

**DAMP** (damping) sets the reverb damping, which is the effect of “soft walls”. The higher the parameter is set the faster the sound will die out. Damping differs from the **DEC** parameter in the way that certain frequencies disappear quicker.

**GATE** (gate sensitivity) sets the gate time. The reverberated signal is gated after this time, if the signal level is low. The maximal value for this parameter gives infinite time - in other words, the gate is turned off.

**MIX** (signal mix) adjusts the output between the original “dry” signal and the reverberated “wet” signal.

**HP** (high pass filter) controls the high pass filtering of the reverb signal.

**LP** (low pass filter) controls the low pass filtering of the reverb signal.

**INP** (input signal amplification) adjusts the signal input.



---

## CHORUS

The Chorus machine implements a 2 x 3 tap stereo chorus.

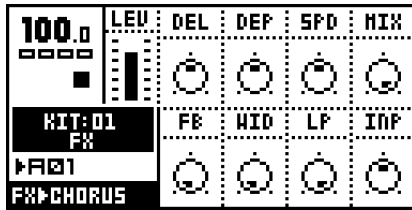

**DEL** (delay) controls the delay time of the taps.

**DEP** (depth) the depth of the modulation of the chorus taps.

**SPD** (speed) sets the low frequency modulation speed of the taps.

**MIX** (signal mix) adjusts the output between the original “dry” signal and the chorused “wet” signal. The best settings are often found in the middle, where the chorus interacts with the original signal.

**FB** (feedback) controls the feedback of the delay taps.

**WID** (stereo width) controls the stereo width output of the chorus.

**LP** (low pass filter) controls the low pass filtering of the feedback signal.

**INP** (input signal amplification) adjusts the signal input.

## DYNAMIX

The Dynamix dynamics processor can be used for increasing the overall sound level of a track or pattern. It can also be used to enhance or reduce transients.

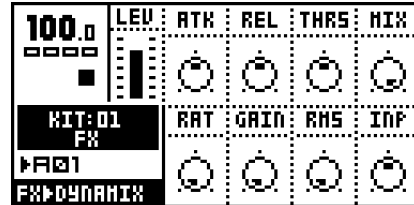

**ATK** (attack) sets the attack time from 0.5 ms to 100 ms.

**REL** (release) sets the release time from 50 ms to 5 s.

**THRS** (threshold) controls the compressor knee threshold.

**MIX** (signal mix) adjusts the output between the original “dry” signal and the “wet” signal.

**RAT** (ratio) sets the compression ratio between 1:1 and 1:255.

**GAIN** (makeup gain) can be used to adjust the output level of the compressor.

**RMS** (RMS measure speed) adjusts the sensitivity for very quick changes in the signal. High RMS values make Dynamix less influenced by very quick signal changes. Setting RMS to zero gives a peak detector and a higher RMS makes Dynamix look more at the over-all energy level of the signal.

**INP** (input signal amplification) adjusts the signal input.

## DYNAMIX TUTORIAL

This is just a general overview of one way you can approach the Dynamix processor. No exact parameter values can be given as they depend on the signal processed.

1. Turn up **RAT**. Setting the compression ratio to zero (1:1) means that the signal will pass straight through. Setting **RAT** to its full value 127 (1:255) makes it a so called *limiter*.
2. Turn **THRS** down. The peaks of the input signal should now be reduced.
3. Increase the **RMS** parameter if the incoming waveform is low in overall volume but have high signal peaks.
4. Adjust **ATK** and **REL** to match the input signal. Too slow attack will cause overshoots (pumping) in the out signal.
5. Increase **GAIN** to compensate for loss of volume.

## RING MODULATOR

The ring modulator of the Monomachine allows you to ringmodulate an incoming signal with an internal carrier oscillator.

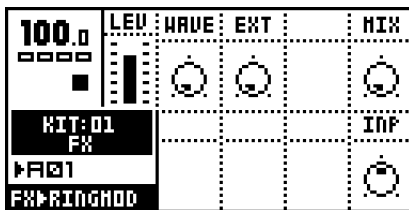

**WAVE** (wave) selects the waveform of the carrier oscillator. When **WAVE** is set to zero the oscillator outputs a sine wave, when set to 127 it outputs a triangle wave.

**EXT** (external signal) sets the amount of the incoming signal that should be ringmodulated with the waveform selected by the **WAVE** parameter.

**MIX** (signal mix) adjusts the output between the original “dry” signal and the “wet” signal.

**INF** (input signal amplification) adjusts the signal input.

## PHASER

The Monomachine phaser lets you apply sweeping effects to your sounds. It can also be used to make sounds appear wider.

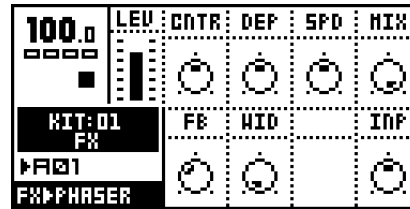

**CNTR** (center) selects the center phase of the phase modulation.

**DEP** (depth) sets the depth of the phase modulation.

**SPD** (speed) adjusts the speed of the phase depth modulation.

**MIX** (signal mix) adjusts the output between the original “dry” signal and the “wet” signal.

**FB** (feedback) controls the feedback of the original signal.

**WID** (width) controls the stereo width of the affected signal.

**INF** (input signal amplification) adjusts the signal input.

## FLANGER

The flanger is a bit similar to the phaser. The main difference is that the frequency notches are evenly spread across the frequency range.

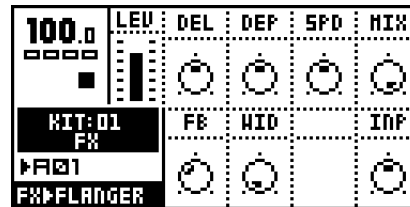

**DEL** (delay) controls the amount of delay of the flanged signal.

**DEP** (depth) controls the depth of the flanger.

**SPD** (speed) adjusts the speed of the flanger.

---

**MIX** (signal mix) adjusts the output between the original “dry” signal and the “wet” signal.

**FB** (feedback) controls the feedback of the original signal.

**WID** (width) controls the stereo width of the affected signal.

**INP** (input signal amplification) adjusts the signal input.



# Appendix B: MIDI CONTROL REFERENCE

All Data Entry parameters of the Monomachine are accessible by both MIDI control change messages and NRPN MIDI messages. This appendix lists the full MIDI implementation of the Monomachine, except SYSEX messages.

## MONOMACHINE MIDI SPECIFICATION

The Monomachine uses up to 6 midi channels starting from the Base channel for the internal sequencer and to control the six tracks of sound generation. This is set in the Global slot->Control->Midichanls.

In addition to that one or none channel can be allocated to each of Multi Trig, Multi Map and the Auto Channel.

The MIDI sequencer can additionally use 6 MIDI channels set in Global slot->Midi seq->Midiseq set.

When receiving midi the Midi sequencer channels are not possible to reach if overlapped by any other channel assignment. It is possible to overlap when sending midi.

By setting the span to 0 and turning Multi Trig, Multi Map and the Auto Channel off, no midi is sent from the Monomachine except if the midi sequencer is used.

Legend:

X - Acknowledged

K - Only sent from the Keyboard version SFX-6

B - Only received on the MIDI Base Channel

## NOTE ON & NOTE OFF MESSAGES

NOTE	MIDI Channel	Track	Action	Trn	Rec
ON	Basechannel+0	1	Trig amp, filter & lfo	X	X
OFF	Basechannel+0	1	Amp in release phase	X	X
ON	Basechannel+1	2	Trig amp, filter & lfo	X	X
OFF	Basechannel+1	2	Amp in release phase	X	X
ON	Basechannel+2	3	Trig amp, filter & lfo	X	X
OFF	Basechannel+2	3	Amp in release phase	X	X
ON	Basechannel+3	4	Trig amp, filter & lfo	X	X
OFF	Basechannel+3	4	Amp in release phase	X	X
ON	Basechannel+4	5	Trig amp, filter & lfo	X	X
OFF	Basechannel+4	5	Amp in release phase	X	X
ON	Basechannel+5	6	Trig amp, filter & lfo	X	X
OFF	Basechannel+5	6	Amp in release phase	X	X



NOTE	MIDI Channel	Mode	Action	Trn	Rec
ON	Multi Trig	All Track	Distributed to track 1-6	X	X
OFF	Multi Trig	All Track	Distributed to track 1-6	X	X
ON	Multi Trig	Split Key	Distributed according to split setting.	X	X
OFF	Multi Trig	Split Key	Distributed according to split setting.	X	X
ON	Multi Trig	Seq Start	Pattern player start or if in play restart. Multi ENV in attack phase. pattern transpose relative MIDI-C4	X	X
OFF	Multi Trig	Seq Start	Multi ENV in release phase.	X	X
ON	Multi Trig	Seq Transp.	Pattern player start only if in stop. Multi ENV in attack phase. Pattern transpose relative MIDI-C4	X	X
OFF	Multi Trig	Seq Transp.	Multi ENV in release phase.	X	X
ON	Multi Map		Action based on settings in global-multimap	X	X
OFF	Multi Map		Action based on settings in global-multimap	X	X
ON	Auto Channel		Distr. to active track		X
OFF	Auto Channel		Distr. to active track		X

## CONTROL CHANGE MESSAGES

MIDI base channel + 0:

Hex	Dec	CTRL Parameter	Trn	Rec
01	01	Track 1 - Joystick Up	K	X
02	02	Track 1 - Joystick Down	K	X
03	03	Track 1 - Mute (0 Unmuted, [1..127] Muted)		X
06	06	NRPN Parameter Val		B
07	07	Track 1 - Level	X	X
0a	10	Track 1 - Amp Pan		X
30	48	Track 1 - Synthesis parameter 1	X	X
31	49	Track 1 - Synthesis parameter 2	X	X
32	50	Track 1 - Synthesis parameter 3	X	X
33	51	Track 1 - Synthesis parameter 4	X	X
34	52	Track 1 - Synthesis parameter 5	X	X
35	53	Track 1 - Synthesis parameter 6	X	X
36	54	Track 1 - Synthesis parameter 7	X	X
37	55	Track 1 - Synthesis parameter 8	X	X
38	56	Track 1 - Amp Attack	X	X
39	57	Track 1 - Amp Hold	X	X
3a	58	Track 1 - Amp Decay	X	X
3b	59	Track 1 - Amp Release	X	X
3c	60	Track 1 - Amp Dist	X	X

3d 61	Track 1 - Amp Vol	X   X
3e 62	Track 1 - Amp Pan	X   X
3f 63	Track 1 - Amp Portamento	X   X
48 72	Track 1 - Filter Base	X   X
49 73	Track 1 - Filter Width	X   X
4a 74	Track 1 - Filter HPQ	X   X
4b 75	Track 1 - Filter LPQ	X   X
4c 76	Track 1 - Filter Attack	X   X
4d 77	Track 1 - Filter Decay	X   X
4e 78	Track 1 - Filter Base Offset	X   X
4f 79	Track 1 - Filter Width Offset	X   X
50 80	Track 1 - Effects EQ Freq	X   X
51 81	Track 1 - Effects EQ Gain	X   X
52 82	Track 1 - Effects SRR	X   X
53 83	Track 1 - Effects Delay Time	X   X
54 84	Track 1 - Effects Delay Send	X   X
55 85	Track 1 - Effects Delay Feedback	X   X
56 86	Track 1 - Effects Delay Filter Base	X   X
57 87	Track 1 - Effects Delay Filter Width	X   X
58 88	Track 1 - LFO 1 Page	X   X
59 89	Track 1 - LFO 1 Dest	X   X
5a 90	Track 1 - LFO 1 Trig	X   X
5b 91	Track 1 - LFO 1 Wave	X   X
5c 92	Track 1 - LFO 1 Multiplier	X   X
5d 93	Track 1 - LFO 1 Speed	X   X
5e 94	Track 1 - LFO 1 Interlace	X   X
5f 95	Track 1 - LFO 1 Depth	X   X
62 98	NRPN Parameter Lo (Parameter)	B
63 99	NRPN Parameter Hi (Track num)	B
68 104	Track 1 - LFO 2 Page	X   X
69 105	Track 1 - LFO 2 Dest	X   X
6a 106	Track 1 - LFO 2 Trig	X   X
6b 107	Track 1 - LFO 2 Wave	X   X
6c 108	Track 1 - LFO 2 Multiplier	X   X
6d 109	Track 1 - LFO 2 Speed	X   X
6e 110	Track 1 - LFO 2 Interlace	X   X
6f 111	Track 1 - LFO 2 Depth	X   X
70 112	Track 1 - LFO 3 Page	X   X
71 113	Track 1 - LFO 3 Dest	X   X
72 114	Track 1 - LFO 3 Trig	X   X
73 115	Track 1 - LFO 3 Wave	X   X
74 116	Track 1 - LFO 3 Multiplier	X   X
75 117	Track 1 - LFO 3 Speed	X   X
76 118	Track 1 - LFO 3 Interlace	X   X
77 119	Track 1 - LFO 3 Depth	X   X
7b 120	Track 1 - All Notes Off	X   X



```
+-----+
|       | MIDI base channel + 1:       |
+-----+
|       | Same as MIDI Base Channel + 0, |
|       | but exchange Track 1 to Track 2 |
+-----+

+-----+
|       | MIDI base channel + 2:       |
+-----+
|       | Same as MIDI Base Channel + 0, |
|       | but exchange Track 1 to Track 3 |
+-----+

+-----+
|       | MIDI base channel + 3:       |
+-----+
|       | Same as MIDI Base Channel + 0, |
|       | but exchange Track 1 to Track 4 |
+-----+

+-----+
|       | MIDI base channel + 4:       |
+-----+
|       | Same as MIDI Base Channel + 0, |
|       | but exchange Track 1 to Track 5 |
+-----+

+-----+
|       | MIDI base channel + 5:       |
+-----+
|       | Same as MIDI Base Channel + 0, |
|       | but exchange Track 1 to Track 6 |
+-----+

+-----+
|       | MIDI Multi Trig channel:      |
+-----+
| 01 01 | ModWeelUp - Resent to track 1-6 | K | X |
+-----+
| 02 02 | ModWeelDown - Resent to track 1-6 | K | X |
+-----+

+-----+
|       | MIDI Multi Map channel:      |
+-----+
| 01 01 | ModWeelUp - Resent to track 1-6 | K | X |
+-----+
| 02 02 | ModWeelDown - Resent to track 1-6 | K | X |
+-----+

+-----+
|       | MIDI Auto Track channel:      |
+-----+
|       | All data resent to active track |   | X |
+-----+
```



## NRPN MAPPING

NRPN Received on MIDI base channel + 0:

Hi	Lo	Val	Parameter	Trn	Rec
00	00	YY ZZ	Track 1 CTRL-parameter YY to val ZZ		X
01	01	YY ZZ	Track 2 CTRL-parameter YY to val ZZ		X
02	02	YY ZZ	Track 3 CTRL-parameter YY to val ZZ		X
03	03	YY ZZ	Track 4 CTRL-parameter YY to val ZZ		X
04	04	YY ZZ	Track 5 CTRL-parameter YY to val ZZ		X
05	05	YY ZZ	Track 6 CTRL-parameter YY to val ZZ		X
70	112	%XXXXXXX	Pitch XXXXXXX for Track 1	X	X
71	113	%XXXXXXX	Pitch XXXXXXX for Track 2	X	X
72	114	%XXXXXXX	Pitch XXXXXXX for Track 3	X	X
73	115	%XXXXXXX	Pitch XXXXXXX for Track 4	X	X
74	116	%XXXXXXX	Pitch XXXXXXX for Track 5	X	X
75	117	%XXXXXXX	Pitch XXXXXXX for Track 6	X	X
7e	126	%XXXXXXX	Amp in release phase on Track X equal to a Note Off on Track X	X	X
7f	127	%XXXXALF	Trig Track X with A=Amp L=LFO F=Filter	X	X

NRPN CTRL-parameter YY mapping:

Range	Destination
00 ... 1f	Synth, Amp, Filter, Effect
20 ... 37	LFO 1, LFO 2, LFO
38 ... 3f	MIDI sequencer
40 ... 45	Multi ENV
127	Level



## OTHER MIDI MESSAGES

### PITCH BEND MESSAGES

-----

MIDI base channel + 0:  
+-----+  
| | Track 1 - Pitchbend | K | X |  
+-----+

MIDI base channel + 1:  
+-----+  
| | Track 2 - Pitchbend | K | X |  
+-----+

MIDI base channel + 2:  
+-----+  
| | Track 3 - Pitchbend | K | X |  
+-----+

MIDI base channel + 3:  
+-----+  
| | Track 4 - Pitchbend | K | X |  
+-----+

MIDI base channel + 4:  
+-----+  
| | Track 5 - Pitchbend | K | X |  
+-----+

MIDI base channel + 5:  
+-----+  
| | Track 6 - Pitchbend | K | X |  
+-----+

MIDI Multi Trig channel:  
+-----+  
| | Pitchbend - Resent to track 1-6 | K | X |  
+-----+

MIDI Multi Map channel:  
+-----+  
| | Pitchbend - Resent to track 1-6 | K | X |  
+-----+

MIDI Auto Track channel:  
+-----+  
| | Pitchbend resent to active track | | X |  
+-----+

### PROGRAM CHANGE MESSAGES

-----

Customizable in the global slot.

+-----+  
| XX | Change pattern XX | B | X |  
+-----+

### SYSTEM COMMON MESSAGES

-----

Customizable in the global slot.

+-----+  
| F2 242 | Song Pointer Position | X | X |  
+-----+

### SYSTEM REALTIME MESSAGES

-----

Customizable in the global slot.

+-----+  
| F8 248 | Timing Clock | X | X |  
+-----+  
| FA 250 | Start | X | X |  
+-----+  
| FB 251 | Continue | X | X |  
+-----+  
| FC 252 | Stop | X | X |  
+-----+

---

# Appendix C: SYSEX REFERENCE

---

This appendix lists all Monomachine SYSEX messages available for external control.

---

## Conventions:

Data printed with a \$ sign is written in hexadecimal format.  
Data printed with a % sign is written in a binary bitfield format.

## Monomachine SYSEX messages

All SYSEX messages start with this sequence.

MIDI Byte	Purpose
\$f0	SYSEX Start
\$00	Europe/USA ID
\$20	Europe ID
\$3c	Elektron Music Machines MAV ID
\$03	Monomachine ID
\$00	Base channel (Padding)

A complete SYSEX message looks like this:

```
$f0,$00,$20,$3c,$03,$00,command,...,$f7
```

## SYSEX global settings sysex dump:

MIDI Byte	Purpose
(SYSEX init)	
\$50	Global settings dump ID
..	Global setting data bytes
\$f7	SYSEX end

## SYSEX global setting dump request:

MIDI Byte	Purpose
(SYSEX init)	
\$51	Global setting dump request ID
%00000aaa	Send global setting %aaa (0 to 7) by sysex
\$f7	SYSEX end

## SYSEX kit sysex dump:

MIDI Byte	Purpose
(SYSEX init)	
\$52	Kit dump ID
...	Kit data bytes
\$f7	SYSEX end

## SYSEX kit request:

MIDI Byte	Purpose
(SYSEX init)	
\$53	Kit dump request ID
%0aaaaaaaa	Send kit number %aaaaaa (0 to 127) by sysex
\$f7	SYSEX end

## SYSEX unused:

MIDI Byte	Purpose
(SYSEX init)	
\$54	None
\$f7	SYSEX end

## SYSEX set current kit name:

MIDI Byte	Purpose
(SYSEX init)	
\$55	Set current kit name ID
...	11 bytes ASCII (7-bit)
\$f7	SYSEX end

## SYSEX set active global setting:

MIDI Byte	Purpose
(SYSEX init)	
\$56	Set active global setting ID
%00000aaa	Set global pos %aaa (0 to 7) as active
\$f7	SYSEX end



SYSEX load pattern:

```
MIDI Byte | Purpose
-----+-----
(SYSEX init)|
    $57 | Load pattern ID
%0aaaaaaa | Load pattern %aaaaaaa (0 to 127)
    $f7 | SYSEX end
```

SYSEX load kit:

```
MIDI Byte | Purpose
-----+-----
(SYSEX init)|
    $58 | Load kit ID
%0aaaaaaa | Load kit %aaaaaaa (0 to 127)
    $f7 | SYSEX end
```

SYSEX save kit:

```
MIDI Byte | Purpose
-----+-----
(SYSEX init)|
    $59 | Save kit ID
%0aaaaaaa | Save kit to pos %aaaaaaa (0 to 127)
    $f7 | SYSEX end
```

SYSEX unused:

```
MIDI Byte | Purpose
-----+-----
(SYSEX init)|
    $5a | None
    $f7 | SYSEX end
```

SYSEX assign machine:

```
MIDI Byte | Purpose
-----+-----
(SYSEX init)|
    $5b | Load machine ID
%00000aaa | Select track %aaa (0 to 5)...
%0bbbbbbb | ...and assign machine %bbbbbbb number
            | (see list below)
%00000ddd | 0 = do not init data pages
            | 1 = init all data pages
            | 2 = init synthesis page (optional parameter)
    $f7 | SYSEX end
```

```
00 GND-GND      | 04 SWAVE-SAW | 03 SID-6581 |
01 GND-SIN      | 05 SWAVE-PULS |           |
02 GND-NOIS     | 14 SWAVE-ENS  |           |
```

```
06 DPRO-WAVE    | 08 FM+-STAT  | 11 VO-VO-6  |
07 DPRO-BBOX    | 09 FM+-PAR   |           |
32 DPRO-DDRW    | 10 FM+-DYN   |           |
33 DPRO-DENS    |           |           |
```

```
12 FX-THRU      |           |           |
13 FX-REVERB    |           |           |
15 FX-CHORUS    |           |           |
16 FX-DYNAMIX   |           |           |
17 FX-RINGMOD   |           |           |
18 FX-PHASER    |           |           |
19 FX-FLANGER   |           |           |
```

SYSEX set track routing:

```
MIDI Byte | Purpose
-----+-----
(SYSEX init)|
    $5c | Set track routing ID
%00000aaa | Route track %aaa (0 to 5)...
%00000bcd | ...to output bus specified by %bcd ...
%00000eee | with inputs specified by %eee
            | (optional parameter)
    $f7 | SYSEX end
```

```
b , BUS EF
c , BUS CD
d , BUS AB

e:0 , NEIGHBOR
e:1 , INF A
e:2 , INF B
e:3 , INF A+B
e:4 , BUS AB
e:5 , BUS CD
e:6 , BUS EF
```

SYSEX digipro waveform sysex dump:

```
MIDI Byte | Purpose
-----+-----
(SYSEX init)|
    $5d | Digipro waveform dump ID
    ... | Digipro waveform data bytes
    $f7 | SYSEX end
```

SYSEX digipro waveform request:

```
MIDI Byte | Purpose
-----+-----
(SYSEX init)|
    $5e | Digipro waveform request ID
%00aaaaaa | Send waveform number %aaaaaa (0 to 63)
    $f7 | SYSEX end
```

SYSEX set Gate box parameter:

```
MIDI Byte | Purpose
-----+-----
(SYSEX init)|
    $5e | Set reverb parameter ID
%00000aaa | Target parameter %aaa (0 to 7)
%0bbbbbbb | Set value to %bbbbbbb (0 to 127)
    $f7 | SYSEX end
```

SYSEX unused:

```
MIDI Byte | Purpose
-----+-----
(SYSEX init)|
    $5f | None
    $f7 | SYSEX end
```

SYSEX unused:

```
MIDI Byte | Purpose
-----+-----
(SYSEX init)|
    $60 | None
    $f7 | SYSEX end
```

SYSEX set tempo:

```
MIDI Byte | Purpose
-----+-----
(SYSEX init)|
    $61 | Set tempo ID
%0aaaaaaa | Upper bits
%0bbbbbbb | Lower bits
    $f7 | SYSEX end
```

Note: Tempo = %aaaaaaabbbbbbb / 24, max 300 BPM, min 30 BPM

SYSEX unused:

```
MIDI Byte | Purpose
-----
(SYSEX init) |
    $62 | None
    $f7 | SYSEX end
```

SYSEX unused:

```
MIDI Byte | Purpose
-----
(SYSEX init) |
    $63 | None
    $f7 | SYSEX end
```

SYSEX unused:

```
MIDI Byte | Purpose
-----
(SYSEX init) |
    $64 | None
    $f7 | SYSEX end
```

SYSEX unused:

```
MIDI Byte | Purpose
-----
(SYSEX init) |
    $65 | None
    $f7 | SYSEX end
```

SYSEX unused:

```
MIDI Byte | Purpose
-----
(SYSEX init) |
    $66 | None
    $f7 | SYSEX end
```

SYSEX pattern dump:

```
MIDI Byte | Purpose
-----
(SYSEX init) |
    $67 | Pattern dump ID
    ... | Pattern data bytes (see separate
        | documentation)
    $f7 | SYSEX end
```

SYSEX pattern dump request:

```
MIDI Byte | Purpose
-----
(SYSEX init) |
    $68 | Pattern request ID
    %0aaaaaaaa | Send pattern %aaaaaaaa
    $f7 | SYSEX end
```

SYSEX song dump:

```
MIDI Byte | Purpose
-----
(SYSEX init) |
    $69 | Song dump ID
    ... | Song data bytes (see separate documentation)
    $f7 | SYSEX end
```

SYSEX song request:

```
MIDI Byte | Purpose
-----
(SYSEX init) |
    $6a | Song request ID
    %000aaaaa | send song %aaaaa (0 to 23)
    $f7 | SYSEX end
```

SYSEX unused:

```
MIDI Byte | Purpose
-----
(SYSEX init) |
    $6b | None
    $f7 | SYSEX end
```

SYSEX load song:

```
MIDI Byte | Purpose
-----
(SYSEX init) |
    $6c | Load song ID
    %000aaaaa | Load song %aaaaa (0 to 23)
    $f7 | SYSEX end
```

SYSEX save song:

```
MIDI Byte | Purpose
-----
(SYSEX init) |
    $6d | Save song ID
    %000aaaaa | Save song to position %aaaaa (0 to 23)
    $f7 | SYSEX end
```

SYSEX unused:

```
MIDI Byte | Purpose
-----
(SYSEX init) |
    $6e | None
    $f7 | SYSEX end
```

SYSEX unused:

```
MIDI Byte | Purpose
-----
(SYSEX init) |
    $6f | None
    $f7 | SYSEX end
```

SYSEX status request:

```
MIDI Byte | Purpose
-----
(SYSEX init) |
    $70 | Request status ID
    %00aaaaaa | Status for parameter %aaaaaa (see list below)
    $f7 | SYSEX end

0x01 Current global slot (0 to 7)
0x02 Current kit number (0 to 127)
0x04 Current pattern number (A1=0, A2=1, ... B1=16, ...)
0x08 Current song number (0 to 23)
0x10 Current sequencer mode (pattern mode=0, song mode=1)
0x20 Current audio mode (mono=0, poly=1)
0x21 Current sequencer mode mode (audio=0, midi=1)
0x22 Current audio track (0 to 5)
0x23 Current midi seq track (0 to 5)
```



SYSEX set status:

```
MIDI Byte | Purpose
-----+-----
(SYSEX init)|
    $71 | Set status ID
    %00aaaaaa | Set parameter %aaaaaa to ...
    %0bbbbbbb | ... value %bbbbbbb
    $f7 | SYSEX end

0x01 Current global slot (0 to 7)
0x02 Current kit number (0 to 127)
0x04 Current pattern number (A1=0, A2=1, ... B1=16, ...)
0x08 Current song number (0 to 23)
0x10 Current sequencer mode (pattern mode=0, song mode=1)
0x20 Current audio mode (mono=0, poly=1)
0x21 Current sequencer mode mode (audio=0, midi=1)
```

SYSEX status response:

```
MIDI Byte | Purpose
-----+-----
(SYSEX init)|
    $72 | Status response ID
    %00aaaaaa | Parameter %aaaaaa has ...
    %0bbbbbbb | ... value %bbbbbbb (see list below)
    $f7 | SYSEX end

0x01 Current global slot (0 to 7)
0x02 Current kit number (0 to 127)
0x04 Current pattern number (A1=0, A2=1, ... B1=16, ...)
0x08 Current song number (0 to 23)
0x10 Current sequencer mode (pattern mode=0, song mode=1)
0x20 Current audio mode (mono=0, poly=1)
0x21 Current sequencer mode mode (audio=0, midi=1)
0x22 Current audio track (0 to 5)
0x23 Current midi seq track (0 to 5)
```

SYSEX unused:

```
MIDI Byte | Purpose
-----+-----
(SYSEX init)|
    $73 | None
    $f7 | SYSEX end
```

TURBOMIDI PROTOCOL SYSEX DESCRIPTION

All TurboMIDI SYSEX messages start with this sequence:

```
MIDI Byte | Purpose
-----+-----
    $f0 | SYSEX Start
    $00 | Europe/USA ID
    $20 | Europe ID
    $3c | Elektron Music Machines MAV ID
    $00 | Generic Elektron product ID
    $00 | Base channel (Padding)
```

A complete SYSEX message looks like this:

\$f0,\$00,\$20,\$3c,\$00,\$00,command,...,\$f7

SYSEX turbomidi speed request

```
MIDI Byte | Purpose
-----+-----
(SYSEX init)|
    $10 | Speed request ID
    $f7 | SYSEX end
```

SYSEX turbomidi speed answer

```
MIDI Byte | Purpose
-----+-----
(SYSEX init)|
    $11 | Speed answer ID
    %aaaaaaa | bit 0 = speed 2, bit 1, = speed 3.3...
    %00000bbb | bit 0 = speed 13.3x, bit 1 = speed 16x,
               | bit 2 = speed 20x
    %ccccccc | contains certified speed bits
    %00000bbb | contains certified speed bits
    $f7 | SYSEX end
```

SYSEX turbomidi speed negotiation (master)

```
MIDI Byte | Purpose
-----+-----
(SYSEX init)|
    $12 | Speed negotiaton ID
    %000aaaaa | Speed 1 value
    %0000bbbb | Speed 2 value
    $f7 | SYSEX end
```

SPEED1 >= SPEED2 (= if certified)  
SPEED1, SPEED2 = 1 requires no handshaking

SYSEX turbomidi speed acknowledgement (slave)

```
MIDI Byte | Purpose
-----+-----
(SYSEX init)|
    $13 | Speed acknowledgment ID
    $f7 | SYSEX end
```

Acknowledge sent upon SPEEDNEG, always sent at 1xMIDI\_SPEED  
After speed acknowledgement is received SPEED1 is set on  
both the master and slave device

SYSEX turbomidi speed test (master)

```
MIDI Byte | Purpose
-----+-----
(SYSEX init)|
    $14 | Speed test (master) ID
    $55 |
    $55 |
    $55 |
    $55 |
    $00 |
    $00 |
    $00 |
    $00 |
    $00 |
    $f7 | SYSEX end
```

Before the speedtest the master should allow the slave some  
breathing by sending 16 0x00 bytes to allow setting of speed  
and resetting of UART

SYSEX turbomidi speed result (slave)

```
MIDI Byte | Purpose
-----+-----
(SYSEX init)|
    $15 | Speed test (result) ID
    $55 |
    $55 |
    $55 |
    $55 |
    $00 |
    $00 |
    $00 |
    $00 |
    $00 |
    $00 |
    $f7 | SYSEX end
```

---

SYSEX turboMIDI speed test 2 (master)

MIDI Byte | Purpose

-----  
(SYSEX init) |  
    \$16 | Speed test 2 (master) ID  
    \$f7 | SYSEX end

SYSEX turboMIDI speed result 2 (slave)

MIDI Byte | Purpose

-----  
(SYSEX init) |  
    \$17 | Speed test 2 (result) ID  
    \$f7 | SYSEX end

After reception of "speed result 2" SPEED2 is set on both the master and slave device.

Possible Speed and Max Speed parameters:

SPEED	x 31.25 kbit	
1	1	
2	2	
3	3.33	
4	4	
5	5	
6	6.66	
7	8	
8	10	
(9)	13.3	
(10)	16	
(11)	20	

Values within parentheses are not supported

Active sensing:

Active sensing should be sent from any device supporting Turbo MIDI whenever a higher speed is used (TM-1 approx 150ms between).

If a Turbo MIDI device receives active sensing and then active sensing is lost for more than 300ms the device will revert to normal MIDI speed.

Negotiation Timing:

Length of master timeouts: 30 ms minimum  
Length of slave timeouts: 15ms minimum, 25 ms maximum

The timeout is for a byte, not a message, a message could take 15xN ms to reach the slave.





---

# INDEX

---

## A

ARPEGGIATOR 61  
Envelope triggering 62  
Mode 61  
Octave jump 62  
Play 62  
Range 62  
Rhythm and offset 63  
Speed 61

## AUDIO

Master tune 88  
Routing 89

## C

### CLEAR

Arpeggiator 62  
Digibank 108  
Kit 21  
Machine 24  
Parameter locks 50  
Slide 66  
Snapshot 107  
Song 74  
Song row 77  
Super clear 55  
Swing 65  
Track 53  
Track page 51

### CONTROL

Control in 92  
Control out 1 91  
Control out 2 92  
Mechanical settings 94  
Midi channels 89  
Multi map edit 93

### CONTROL IN 92

Program change 93  
Tempo sync 92  
Transport 92

### CONTROL OUT 1 91

### CONTROL OUT 2 92

Midi clock 92  
Program change 92  
Transport 92

### COPY/PASTE

Arpeggiator 62  
Digibank 108

Kit 21  
Machine 23  
Note 50  
Pattern 53  
Slide 66  
Snapshot 107  
Song 74  
Song row 77  
Super copy 54  
Swing 65  
Track 52  
Track page 51

## D

### DATA PAGES

Amplification page 26  
Effects page 32  
Filter page 29  
Lfo pages 35

### DELAY 33

### DIGIPRO MANAGER 99

Erase waveforms 103  
Receive waveforms 100  
Rename waveforms 104  
Send waveforms 102

### DISTORTION 27

## E

### EARLY START UP MENU 110

### EDIT

Parameter 25  
Pattern 47  
Song 76

### ELECTRICAL SPECIFICATIONS 113

### EMPTY RESET 110

### EQ 32

## F

### FACTORY RESET 110

### FILE

+Drive settings 105  
Digibank manager 107  
DigiPro manager 99  
Snapshot manager 106  
Sysex receive 97  
Sysex send 95

### FILTER 29

Basic filter controls 30  
Filter envelope 31  
Filter tracking 31



## G

### GLOBAL SETTINGS 87

- Audio 88
- Control 89
- File 95
- Midi sequencer 108
- Turbo menu 87

### GRID RECORDING 47

## K

### KEY TRACKING 40

#### KIT

- Clear 21
- Copy 21
- Joystick assign 39
- Key tracking 40
- Load 19
- Multi trig 41
- Save 19
- Trig track settings 40
- Undo 20
- Velocity 39

## L

### LFO 35

### LIVE RECORDING 49

#### LOAD

- Kit 19

## M

### MECHANICAL SETTINGS 94

#### MIDI

- Auto track channel 90
- Base channel 90
- Channel span 90
- Control in 92
- Control out 1 91
- Control out 2 92
- Multi map channel 90
- Multi map edit 93
- Multi trig channel 90

### MIDI CHANNELS 89

### MIDI CLOCK 92

### MIDI SEQUENCER 70

### MIDI UPGRADE 111

### MULTI ENVELOPE 43

### MULTI MAP EDIT 93

### MULTI TRIG 41

#### MUTE

- Song mute 79
- Track 67

## O

### OS UPGRADE

- Receive upgrade 111
- Send upgrade 111

## P

### PAN 29

### PARAMETER EDITING 25

### PARAMETER LOCKS 57

- Grid recording mode 57
- Live recording mode 58
- Trigless trigs 59

### PATTERN

- Grid recording 47
- Live recording 49
- Pattern chaining 46
- Pattern selection 45
- Scale setup 46
- Step recording 50

### POLY MODE 69

### PORTAMENTO 29

### POWER SUPPLY

- MKI specifications 114
- MKII specifications 7

## R

### RACK MOUNT KIT 8

#### RECORDING

- Grid recording 47
- Live recording 49
- Step recording 50

#### RESET

- Empty 110
- Factory 110
- Soft 111

#### ROUTING 81

- Audio inputs 82
- Fx machines 81
- Global 89
- Mix bus routing 84
- Monomachine mixer 81
- Neighbor routing 83
- Routing mode 6x mono 85
- Routing mode ab=mix 85

## S

### SAMPLE RATE REDUCTION 32

#### SAVE

- Kit 19

### SCALE SETUP 46

### SEND UPGRADE 111

### SLIDE 66

---

SOFT RESET 111  
SONG MODE 73  
  Bpm 79  
  Edit song 76  
  Load song 73  
  Mute 79  
  Save song 74  
  Song halt 78  
  Song jump 78  
  Song loop 78  
  Song play 75  
  Song track transpose 79  
STEP RECORDING 50  
SWING 64  
SYSEX RECEIVE 97  
SYSEX SEND 95

## T

TECHNICAL INFORMATION 113  
TEMPO 55  
  Tap tempo 56  
  Tempo nudge 56  
  Tempo sync 92  
TEMPO SYNC 92  
TEST MODE 110  
TRACK EFFECTS 26  
  Amplifier envelope 26  
  Basic filter controls 30  
  Delay 33  
  Distortion 27  
  Eq 32  
  Filter 29  
  Level 26  
  Pan 29  
  Portamento 29  
  Sample rate reduction 32  
  Track volume 28  
TRACK VOLUME 28  
TRANSCOPE 63  
  Pattern 64  
  Scale 64  
  Song track 79  
  Track 64

TRIG TRACK  
  All 59  
  Amp 59  
  Filter 59  
  Lfo 59  
TRIG TRACK SETTINGS 40  
TRIG TRACKS 58  
TRIGLESS TRIGS 59  
TURBO MENU 87

## U

UNDO  
  Arpeggiator clear 62  
  Arpeggiator paste 62  
  Digibank clear 108  
  Digibank paste 108  
  Kit 20  
  Machine clear 24  
  Machine paste 24  
  Parameter lock clear 51  
  Pattern clear 54  
  Pattern copy 54  
  Slide clear 66  
  Slide paste 66  
  Snapshot clear 107  
  Snapshot paste 107  
  Song clear 74  
  Song paste 74  
  Song row 77  
  Super clear 55  
  Super copy 55  
  Swing clear 65  
  Swing paste 65  
  Track clear 53  
  Track copy 52  
  Track page clear 52  
  Track page paste 51

## V

VOLUME  
  Level 26  
  Track volume 28





