

**MASTER**

MASTER

**CZ-5000**

**SUMMARY/SUMARIO**

**The quick approach to sound synthesis**  
**Una rápida aproximación a la síntesis sonora**

**CASIO**



This booklet explains the operation of the Casio CZ-5000 from a different viewpoint than the Operation Manual.

It was written with people in mind who want to play their new instrument right away, who are less interested in theory and more in practical tips for creating new sounds.

For those who have no experience with synthesizers at all and are using one for the first time, the appendix "Synthesizer Sound Seminar" is recommended reading.

**Contents**

---

<b>Part 1</b>	First, Let's Create Some Sounds!.....	1
<b>Part 2</b>	CZ-5000 Sound Synthesis.....	6
<b>Part 3</b>	Tips for Sound Synthesis—Effective Techniques.....	10
<b>Part 4</b>	Using the Sequencer.....	15
<b>Appendix</b>	"The Synthesizer Sound Seminar".....	18

---

TH  
M  
Us

(1)

Im.  
the  
EN  
sele  
pre  
LC

(2)

Use  
tim!  
nex  
pres  
narr  
tim!

(3)

Use  
timb  
next  
mem  
name  
timb

# First, Let's Create Some Sounds!

## 64 Sample Sounds

The CZ-5000 contains a total of 64 built-in sample sounds composed of 32 preset and 32 memory voices. Memory voice contents change when newly created sounds are stored to memory. Use the following procedure to listen to the sample sounds.

The CZ-5000 synthesizer is not equipped with speakers, so a keyboard amplifier and speakers, or ear-phones must be used to produce sound.

### (1) Press the power switch to turn the instrument ON.

Immediately after power is turned ON, the synthesizer will be in the NORMAL mode and BRASS ENS. 1 (A-1 in the Programmer Section) will be selected automatically. Indicators will be lit above preset bank A and voice selector 1, while the LCD will appear as shown below.

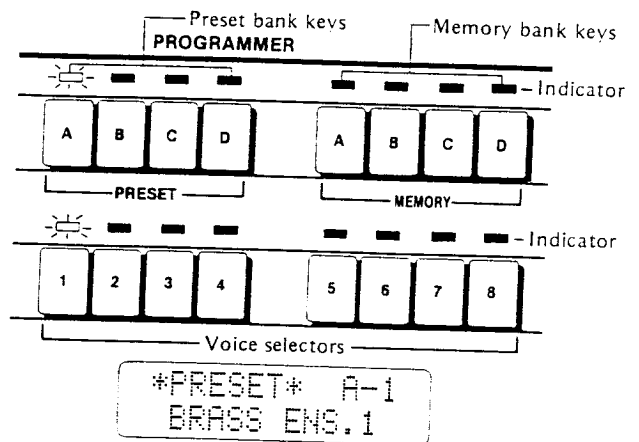

### (2) Playing the 32 preset voices.

Use the voice selectors (1-8) for the first eight timbres, and then press preset bank key B for the next eight timbres. Repeat this procedure for each preset bank key (A-D). The LCD will show the name of each timbre selected, so sample each timbre while confirming its name on the LCD.

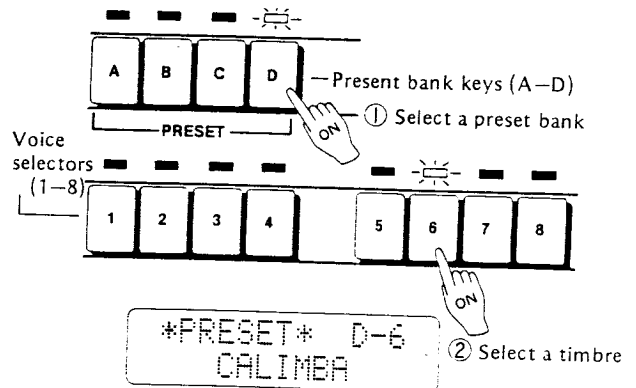

### (3) Playing the 32 memory voices.

Use the voice selectors (1-8) for the first eight timbres, and then press memory bank key B for the next eight timbres. Repeat this procedure for each memory bank key (A-D). The LCD will show the name of each timbre selected, so sample each timbre while confirming its name on the LCD.

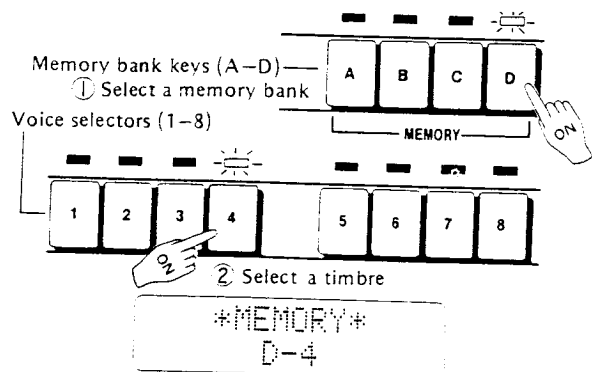

## Preset Voices and Memory Voices

32 preset and 32 memory voices are preprogrammed into the CZ-5000. Any one of these 64 timbres can be selected using the keys in the Programmer Section.

The 32 timbres programmed into the memory bank are those included in the "DATA BOOK". Newly created timbres (by changing data using the Parameter Section) can be stored in memory erasing the previous contents and recording the new data in its place.

Preset Voice Table

\* indicates 16-note polyphonic (1DCO).  
Others are 8-note polyphonic (2DCO).

BANK No.	A	B	C	D
1	BRASS ENSEMBLE 1	SYNTH. BRASS	BRASS ENSEMBLE 2	TRUMPET
2	STRING ENSEMBLE 1	STRING ENSEMBLE 2	SYNTH. STRINGS	VIOLIN*
3	JAZZ ORGAN	ELEC. PIANO	ACCORDION	FANTASTIC ORGAN
4	WHISTLE*	FLUTE*	BLUES HARMONICA	DOUBLE REED
5	FAT BASS	SYNTH. BASS	ELEC. GUITAR	METALLIC SOUND
6	VIBRAPHONE	CRISPY XYLOPHONE	SYNTH. GLOCKENSPIEL	CARIMBA
7	SYNTH. DRUMS	STEEL DRUM	SYNTH. PERCUSSION	CONGA
8	HUMAN VOICE	FAIRY TALE	CARILLON	TYPHOON SOUND

## Altering the sample voices

There are two methods for creating your own sounds with the CZ-5000. You can either select a sample sound that is already close to the kind of tone you would like and alter it to suit your taste, or else combine the various tone elements to synthesize a new sound right from the beginning. Here we will explain the first method of altering a sample sound to make it easier to understand how sound synthesis with the CZ-5000 actually works.

No detailed explanations will be provided for the various numeric values that appear in the following examples. Simply change the sounds as instructed to gain experience in creating new sounds. Refer to page 15 of the Operation Manual for details.

Example: Changing the preset tone B-1 "Synth. Brass" into an exotic "Oriental Brass" sound and storing it in internal memory D-8.

(1) Select the preset tone B-1 "Synth. Brass".

(2) Raise the range one octave.

① Press the OCTAVE key.

➔ The display shown on the right will appear on the LCD. [This indicates that the octave setting for SYNTH. BRASS is currently "RANGE = 0".]

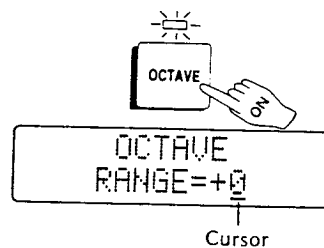

\* The cursor is the mark that indicates the position at which a value can be changed.

**NOTE**

Whenever you press any key such as VIBRATO, WAVE FORM, ENV, etc., the respective value set for the selected tone will be displayed in the same manner as shown for the octave range setting above. Pressing these buttons again returns the LCD to the previous display.

- ② Press the  key once.
- ➔ The value above the cursor changes to "+1" and the pitch range is thus shifted up by one octave.

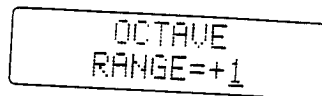
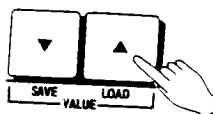

**The COMPARE/RECALL Key**

When you perform the operation described above in ①-②, the indicator above the COMPARE/RECALL key will light indicating that a sample sound has been altered. (In our example, the pitch range of the tone "Synth. Brass" has been raised by one octave.) If you now press the COMPARE/RECALL key, the indicator will go out and you will be able to hear the original (unaltered) sample sound (i.e. in our case the Synth. Brass tone). Press the key to compare the sounds before and after alteration. By using this button and simply pressing a key on the keyboard, you can listen to the sound you are altering as well as the original sound any time.

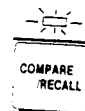

**Note:** Press the COMPARE/RECALL key again after comparing an altered sound with the original. This will return to the partially altered sound (indicator will light) and allow further modifications.

**(3) Change the pitch envelope to achieve a wavering effect during the attack.**

- ① Press the DCO 1 ENV key.
- ➔ The LCD will show the display on the right.  
[The parameter values for Step 1 of the pitch envelope are "RATE = 99" and "LEVEL = 33". The cursor is positioned under the RATE value.]

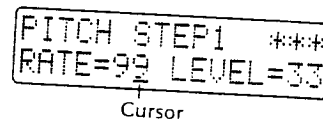
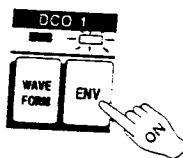

- ② Press the  key to display Step 2 of the envelope.
- ➔ The LCD will show the display on the right.

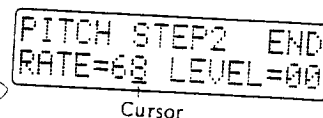
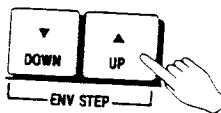



**NOTE**

By performing the operations explained in the steps above, the parameter values for "Synth. Brass" are RATE = 99, LEVEL = 33 for Step 1 and RATE = 68, LEVEL = 0 for Step 2, producing the envelop shown on the right. The "rate" parameters indicate the "attack angle" while the "level" parameters show the "height" of the envelope for the respective steps. The maximum value for each of these parameters is 99 while the minimum value is 0.

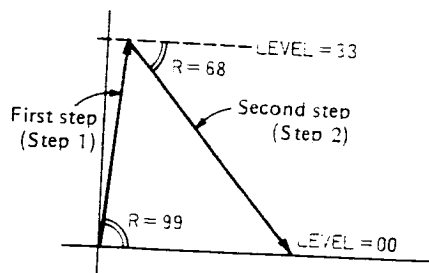
➔ See page 15 ~ 19 of the Operation Manual for details.



- ③ Press the  key to set the value to 50.
- \* Each time the  key is pressed, the value will decrease by 1. Keeping this key depressed will cause the value to decrease continuously. If the value has decreased beyond the desired point, simply press the  key to increase it again.

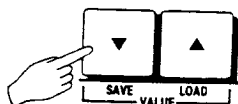

```
PITCH STEP2 END
RATE=50 LEVEL=00
```

**NOTE**

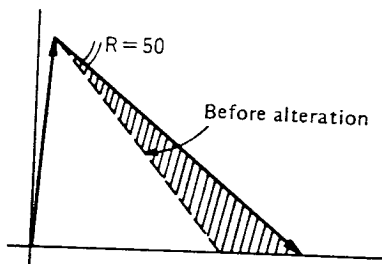

The operation explained in ③ changes the rate (slope) of Step 2 from 68 to 50, producing the pitch envelope illustrated on the right.

- \* The wavering effect, which is determined by the angle of the slope, will now be stronger due to the gentler slope of the envelope (indicated by the shaded section).



- \* Press the COMPARE/RECALL key in order to compare the altered sound with the previous one. After comparison, return to the altered sound by pressing the compare/recall key again. (The indicator will light.)

**(4) Change the DETUNE value to add a perfect fifth harmony.**

- ① Press the detune key.  
 → The LCD will show the display on the right.
- ② Press the  key to move the cursor to the position below the NOTE value.
- ③ Press the  key to change the NOTE value from 00 to 07.



```
DETUNE(+) OCT=0
NOTE=00 FINE=06
```

```
DETUNE(+) OCT=0
NOTE=00 FINE=06
```

```
DETUNE(+) OCT=0
NOTE=07 FINE=06
```

**NOTE:** A perfect fifth is the note seven semitones above the root (basic note).

- \* Play something on the keyboard to listen to the new tone, a brass sound with an oriental feeling to it.

**(5) Store the sound in MEMORY D-5.**

- ① Set the PROTECT switch on the back of the synthesizer to OFF.
- ② Keep the WRITE key depressed until the operation of step ④ is completed.
- The LCD will show the display on the right. All indicators in the Programmer section except the COMPARE/RECALL indicator will go out.



```
WRITE
SELECT MEMORY!
```



cause the  
the 

③ Press the D key in the memory bank.  
The indicator will light.

④ Press voice selector key 5. When "OK" appears on  
the LCD, the WRITE key and voice selector key can  
be released.

WRITE  
OK!

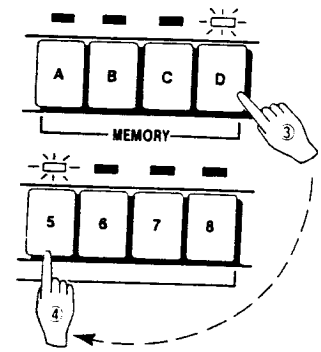

- \* The newly created memory timbre can be recalled using the same procedure outline previously.
- \* The 32 timbres in the memory bank can be stored to separately available cassette tape or an optional RAM cartridge. See "TIMBRE DATA WRITE/SAVE/LOAD" in the user's manual.

. After  
or will

it.

# CZ-5000 Sound Synthesis

## Block Structure of the CZ-5000 (as compared to an Analog Synthesizer)

The fascinating thing about the CZ-5000 is not only its realistic, clear sound, but also the simplicity of sound creation it offers. The CZ-5000 eliminates one of the major drawbacks of previous digital synthesizers, namely that it was extremely difficult to actually synthesize the kind of sound one had in mind. You can now easily create any sound you want as you please. The secret behind this ability is that the CZ-5000 has inherited the basic easy-to-understand structure of sound synthesis from the analog synthesizer. In other words, the CZ-5000 combines the superior sound quality of a digital synthesizer with the easy-to-understand principles of sound synthesis offered by analog instruments. In the following, we will explain the block structure of the CZ-5000 while comparing it to that of an analog synthesizer.

**Note:** To those of you who have never used synthesizers before, we strongly recommend reading the appendix "Synthesizer Sound Seminar" first.

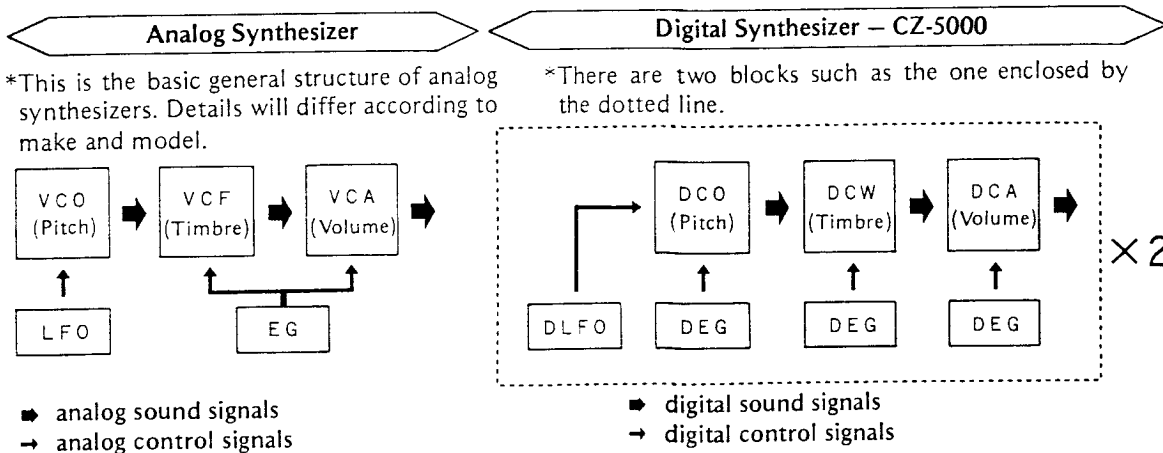

Looking at the above diagram, it is evident that the CZ-5000 has practically the same block structure as analog synthesizers.

- **DCO (Digital Controlled Oscillator)**  
 – A digital circuit that corresponds to the VCO (Voltage Controlled Oscillator) of an analog synthesizer, and determines the pitch and the basic wave form\* of a sound.
- \* The CZ-series offers about 10 times as many basic wave forms as a normal analog synthesizer.
- **DCW (Digital Controlled Wave)**  
 – A digital circuit that corresponds to the VCF (Voltage Controlled Filter) of an analog synthesizer, and controls the timbre of a sound.
- **DCA (Digital Controlled Amplifier)**  
 – A digital circuit that corresponds to the VCA (Voltage Controlled Amplifier) of an analog synthesizer, and controls the volume of a sound.
- **DEG (Digital Envelope Generator)**  
 – Corresponds to the EG (Envelope Generator) of an analog synthesizer, and controls the change of pitch, timbre and volume over time according to a maximum of 16 parameters.



- **DLFO (Digital Low Frequency Oscillator)**

- A circuit that corresponds to the LFO (Low Frequency Oscillator) of an analog synthesizer, and generates low frequency waves for vibrato effects.

This shows how easy it is to view the various blocks of the CZ-5000 along the lines of analog synthesizers, meaning that it is possible to create totally new sounds without having to learn any new kind of synthesis. Note that the CZ-5000 offers a dual line systems consisting of the blocks shown above, resulting in the block structure shown below.

## Detune and Line Select

The CZ-5000 has a dual line structure (Line 1 and Line 2):

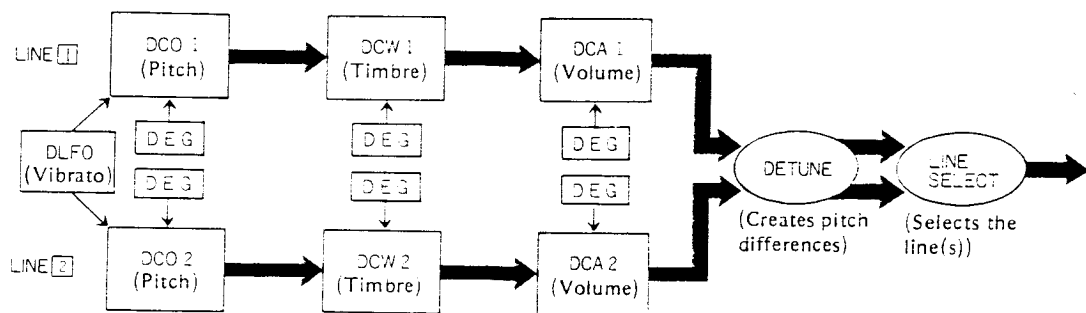

After sounds have been created on Line 1 and/or 2, pitch differences can be obtained with the Detune function and line outputs can be designated with Line Select.

- **Detune** . . . . . Determines the pitch difference between Line 1 and Line 2. (Note 1)  
The pitch difference can be designated in units of one octave, one semitone or 1/60 semitone. It is also possible to designate whether the pitch is raised (+) or lowered (-).
  - **Line Select** . . . . . Determines which lines are output or which lines are combined. (Note 2)  
    - 1 : Outputs Line 1 only.
    - 2 : Outputs Line 2 only.
    - 1 + 2 : Line 1 is output together with detuned Line 2.
    - 1 + 1 : Line 1 is output together with detuned Line 1.
- \* 1 and 2 indicate detuned lines.

**Note 1:** When 1 + 2 is designated with Line Select, Line 1 is output together with detuned Line 2 (Line 1 with an altered pitch). In other words, setting a Detune value will detune Line 2 when 1 + 2 is designated and Line 1 when 1 + 1 is designated.

**Note 2:** When 1 or 2 have been designated with Line Select, the synthesizer is 16-note polyphonic. When 1 + 1 or 1 + 2 have been designated, it is 8-note polyphonic.

The Detune and Line Select functions let you create a variety of effects by combining the different sounds on each line or detuned and normal-pitch tones for a fatter, spacier sound, or to obtain various nuances. For example, by combining a normal-pitch string tone with a slightly detuned string tone, you can achieve an even more realistic sound. Another interesting example is the combination of an organ tone with key click noise for a funky jazz organ sound. As you can see, the Detune and Line Select functions play important parts in CZ-5000 sound synthesis.

# Key Relationship and Operation

To get an idea about the relationship among the various keys, first look at the following diagram:

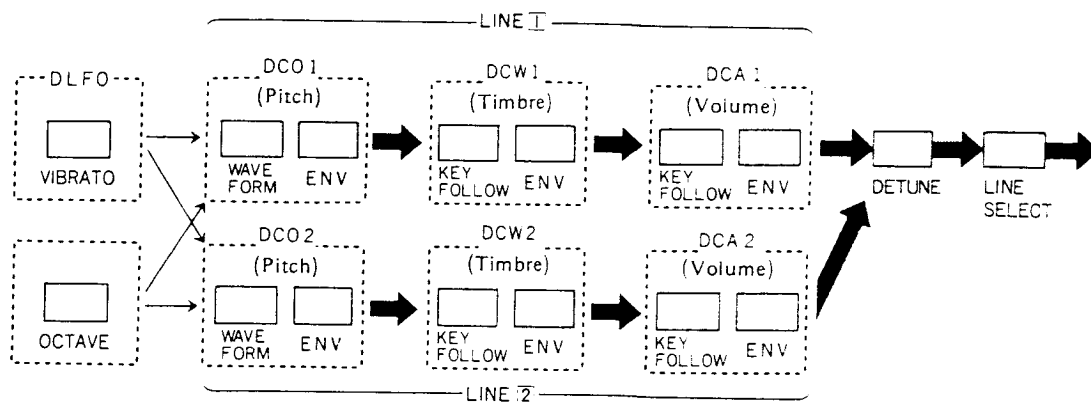

Compare this diagram with the one on page 16. The DEG for each block is indicated by the ENV (envelope) keys for DCO 1, DCW 1, etc. Also, OCTAVE controls both DCO 1 and DCO 2. The key layout more or less corresponds to the block structure shown in the diagram on page 16.

There are 16 keys in all. With the exception of the LINE SELECT key on the extreme right, all other 15 keys cause the values set for the respective blocks to be displayed on the LCD when pressed. These 15 keys are called parameter keys.

CZ-5000 sound synthesis is accomplished by displaying the values for the blocks you want to alter on the LCD by pressing the respective key and then altering the displayed values with the CURSOR keys (◀ and ▶), and the VALUE keys (SAVE and LOAD).

## Basic Procedure for Sound Synthesis

\* Procedure for altering sample sounds.

### Operation Example in Part 1

**1**  
Select the timbre you want to use as the basis for your sound from among the sample sounds (preset and memory voices).

(1)

**2**  
Press the respective parameter key to display the values for the block you wish to change on the LCD.

(2) - ①

(3) - ①

(4) - ①

**3**  
Use the CURSOR keys and VALUE keys to change the displayed values.

- (2) - ②
- (3) - ② ③
- (4) - ② ③

When you want to alter more than one block, repeat steps ② and ③.

**4**  
Select the line(s) you want to output with LINE SELECT.

\*This operation is not explained in Part 1 since the output line is not changed in the example.

**5**  
Store the synthesized sound in the internal memory or cartridge memory.

- (5) - ① ② ③ ④

\* The settings for RING and NOISE are performed in ② ~ ④.

The notations to the right of the diagram refer to procedures explained in Part 1: "First, Let's Create Some Sounds!" See the respective sections for detailed operational procedures. Refer to the Operation Manual for the meanings of the settings for each block.







# Sound Synthesis Tips

## Sound Synthesis Tips

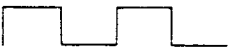
### (1) Choosing the Waveform

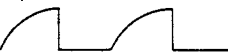
The waveform is one of the most important factors which determine a sound. The first step to successful sound synthesis is therefore to understand the characteristics of the various waveforms.

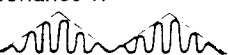
The following table shows the major characteristics of each wave form preset on the CZ-5000 synthesizers. (Select preset tone No. 1 "Brass Ens 1" and switch to the waveforms indicated below.)

Waveform	Characteristic
1. Saw-tooth 	A bright timbre suited to strings and brass sounds.
2. Square 	A simple timbre suitable for woodwinds such as clarinet and oboe.
3. Pulse 	A sharp timbre for funky sounds.
4. Double sine 	A shrill, bright timbre.
5. Saw pulse 	A brassy, metallic timbre.
6. Resonance I 	A funky timbre with characteristics depending on the WAVE ENVELOPE setting.
7. Resonance II 	A funky timbre with characteristics depending on the WAVE ENVELOPE setting.
8. Resonance III 	A funky timbre with characteristics depending on the WAVE ENVELOPE setting.

Selecting any one of the waveforms 1 to 5 and setting the wave envelope level set to 0 outputs a sine wave. This technique is used to output sine waves when necessary.

\* As already noted, the DCO waveform setting determines the basic waveform. With the CZ-5000, this basic waveform actually varies over time, controlled by the wave envelope (DCW). (With the PD sound source, the variation is between a sine wave and the basic wave. See "PD Sound Source and Waveform Variation" on page 14).

## (2) Using the DCO Envelope Generator (Pitch Envelope)

### ① Percussive attack using the pitch envelope

Setting a fast attack (rise) and decay (drop) time for the pitch envelope creates a sound with a percussive attack. Note, however, that this percussive attack will not be audible if the attack of the DCA envelope is too slow.

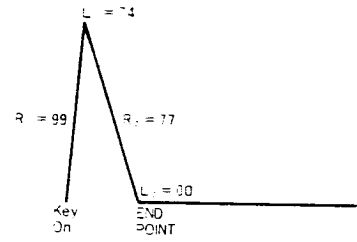

### ② Auto glide effect using the pitch envelope

First, the pitch envelope is set so that it rises very quickly to a point just below one octave in Step 1. The Step 1 rate of the DCA envelope is set to about 60 so that the first step of the pitch envelope cannot be heard.

The second step of the pitch envelope is set so that the envelope slowly approaches the one octave ( $L = 66$ ) pitch and then a sustain point is specified.

This setting produce an auto glide effect causing the pitch to slowly rise when a key is pressed.

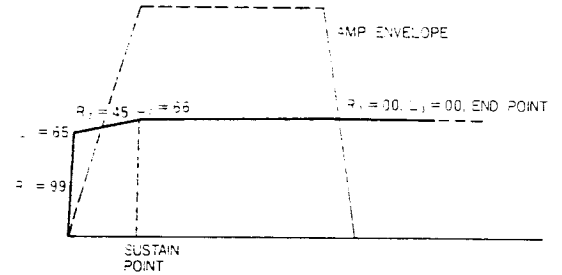

### ③ Using the pitch envelope to produce a guitar sound with distortion and picking effects

Causing the pitch to oscillate rapidly within a one-octave range produces a distorted guitar sound with picking effects.

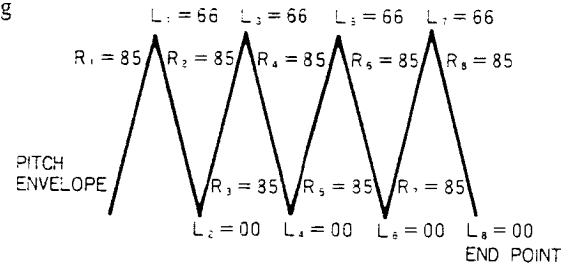

## (3) Using the DCW Envelope Generator (Wave Envelope)

### ① Wah-wah sound

Select any of the resonance wave forms (I-III).

By setting the wave envelope as shown below, a wah-wah effect can be achieved.

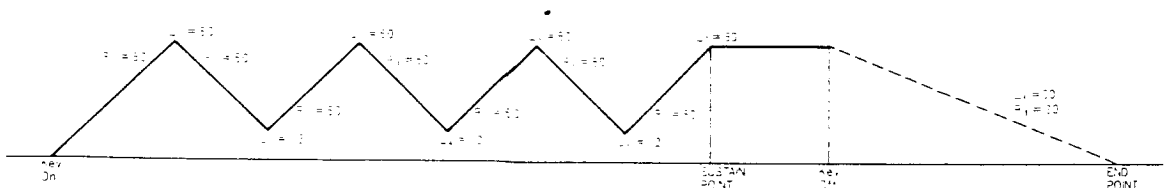

## PD Sound Source and Waveform Variation

The CZ-5000 features a PD sound source that produces a variety of waves by controlling the speed at which a sine wave is read from ROM. (See User's Manual for details.) In actual practice, the wave is altered over time between the basic waveform and a sine wave in accordance with the envelope formed with the ECW envelope generator. (Fig. 1)



WAVEFORM 1

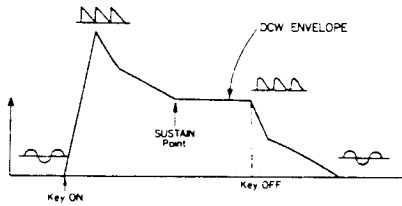

WAVEFORM 7 (RESONANCE II)

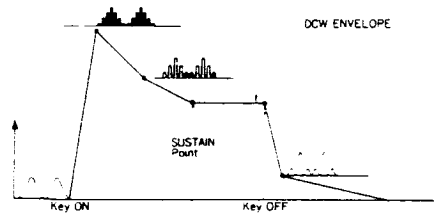

### ② Fixed timbre organ

As can be seen in the figure, fixing the wave envelope at a constant level produces a specific waveform irregardless of time (like an organ).

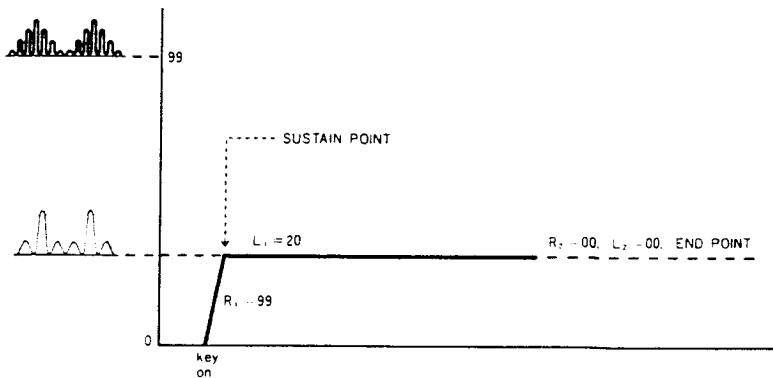

### (4) Using the DCA Envelope Generator (Amp Envelope)

#### ① Echo effect

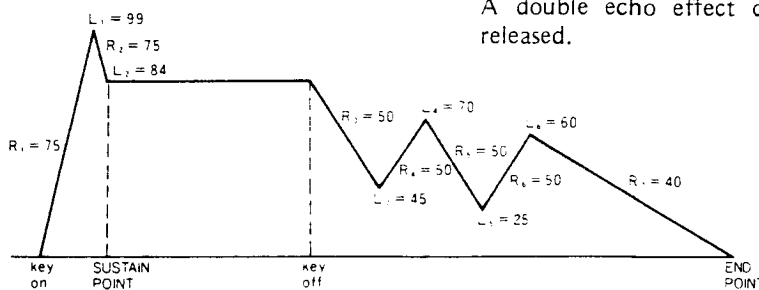

A double echo effect can be obtained when a key is released.

② Pi  
If a k  
is des  
= 00  
With  
it is re

③ Bra  
Setting  
duces  
instru

(5) Us  
Besides  
timbre  
higher

① DC  
The hig  
is gradu

② DC  
The hig  
so deca  
the plu

speed  
wave  
envelope

### ② Piano-like envelope with sudden decay

If a key is released before the Sustain Point is reached, the envelope jumps to the step where the End Point is designated. This can be achieved by setting the Sustain Point in a step where the decay is complete (level = 00) and entering a relatively fast rate for the following step, where the End Point is set. With this kind of envelope, the sound will expand as long as the key is pressed and decay suddenly when it is released.

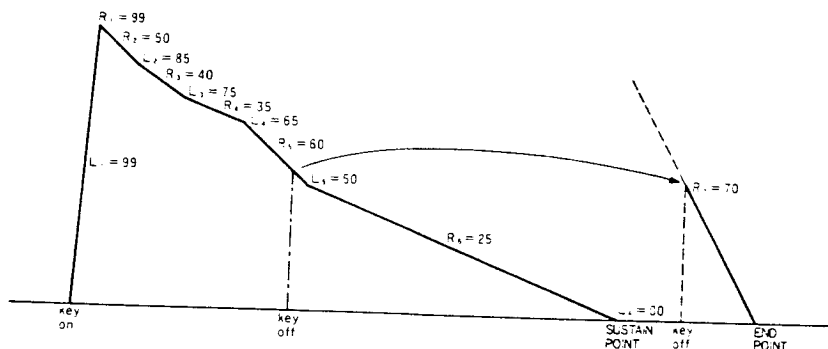

### ③ Brass wind instruments with a tonguing effect

Setting the attack of the envelope as shown below produces the kind of tonguing effect typical of brass wind instruments.

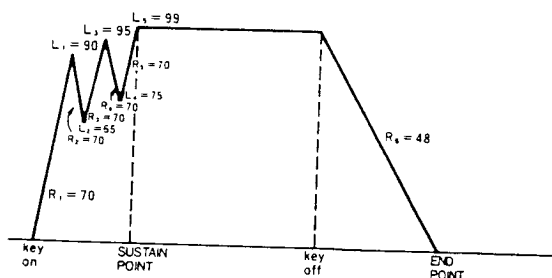

### (5) Using key follow

Besides altering the timbre and volume over time in DCW and DCA, key follow also produces change in the timbre in accordance with the pitch of the keyboard key. In the case of a piano timbre, for example, the higher the pitch, the rounder the timbre and the faster the decay.

#### ① DCW Key Follow

The higher the pitch the lower the timbre modulation factor. A sine wave is approached, so a round timbre is gradually formed. The higher the range value, the greater the effect.

#### ② DCA Key Follow

The higher the pitch, the larger each step rate (slope) in the amp envelope. The enveloped is reduced over time, so decay is faster. The higher the range value, the greater the effect. This setting is very effective in producing the plucked string effect of the guitar and piano.

## (6) Effective Use of the Detune Function

Select Electric Piano B-3 and set the Detune parameters as follows.

+/-	Octave	Note	Fine	Effect
-	2	00	00	Fatter sound.
-	1	00	00	Fatter sound.
-~+	0	00	01~07	Ensemble. Particularly effective in combination with Line Select setting $\text{1} + \text{1}$ .
+	1	00	00~07	Fatter sound. Accentuates harmonic one octave above basic pitch.
+	1	07	00	Accentuates third harmonic. Well suited to brass and organ sounds.
+	2	00	00~07	Accentuates harmonics two octaves above basic pitch. Suited to electric piano sounds and electric organ sounds.
+	2	03	48	Accentuates fifth harmonic. (Sound of hitting wood)
+	2	09	36	Accentuates sixth harmonic.
+	3	00	00	Accentuates seventh harmonic.
+	3	00	00	Accentuates harmonic three octaves above basic pitch.
+	3	02	00	Accentuates ninth harmonic.
+	3	03	48	Accentuates tenth harmonic.
+	3	05	30	Accentuates eleventh harmonic.
+	3	07	00	Accentuates twelfth harmonic. (Sound of hitting glass)
+	3	08	24	Accentuates thirteenth harmonic.
+	3	09	36	Accentuates fourteenth harmonic.
+	3	10	54	Accentuates fifteenth harmonic. (Metallic sound)

**Note:** The values for the FINE setting are included as examples and do not have to be followed precisely.

## (7) Modulation

### ① Ring Modulation

Turning ring modulation ON while the line select is set to  $\text{1} + \text{1}$  (or  $\text{1} + \text{2}$ ), multiplies line  $\text{1}$  by line  $\text{1}$  (or  $\text{2}$ ), and a timbre modulated by line  $\text{1}$  (or  $\text{2}$ ) is produced. The ring modulated tone includes the pitch of line  $\text{1}$  and pitches not included in line  $\text{1}$  (or  $\text{2}$ ) (non-integral multiples) for a metallic sound, such as bell.

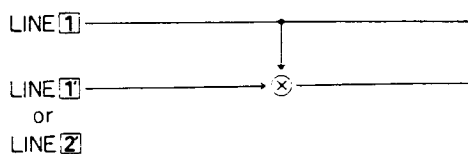

### ② Noise Modulation

Turning noise modulation ON while the line select is set to  $\text{1} + \text{1}$  (or  $\text{1} + \text{2}$ ) produces a timbre in which  $\text{1}$  (or  $\text{2}$ ) is modulated by noise. This is effective for producing wind or wave effects.

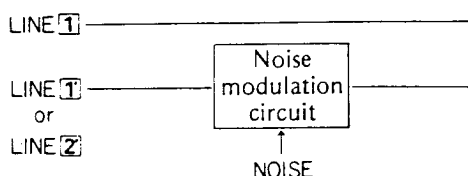

The p  
repre  
The S  
stored  
creativ

\* TH

A. M

The c  
tronics  
music  
The se  
note d

B. E

With  
be ch  
chang  
The s  
slowly  
flying

C. E

Once  
violin  
If the  
be ch  
can fr



# Using The Sequencer

## What is a Sequencer?

The power of a computer lies in its ability to store volumes of data. There are many ways that music can be represented as data, but the most popular is sheet music.

The SEQUENCER makes it possible to input musical notes as they appear on the sheet music as data. The stored piece can then be played back automatically, thus providing vast potential for new types of musical creativity. Actually, the sequencer is a type of recorder.

### \* THE DIFFERENCE BETWEEN A SEQUENCER AND A TAPE RECORDER

#### A. Manual Recording for Non-Musicians

The concept that musical instruments are only for musicians is a thing of the past thanks to modern electronics. With conventional tape recorders, considerable skill was required to make recordings of one's own music if any degree of success was desired.

The sequencer of the CZ-5000 makes it possible for beginners who possess basic music reading skills to input note data to form complete tunes for playback.

#### B. Easy Automatic Playback Tempo Changes

With standard tape recorders it is impossible to control tape speed, so the tempo of recorded pieces cannot be changed. (Even tape players capable of variable speed cannot maintain the same pitch when speed is changed.)

The sequencer, on the other hand, provides full control over tempo. This means that the notes input very slowly on the keyboard can be sped up to make the finished product sound like your fingers were literally flying over the keys.

#### C. Easy Timbre Changes After Recording

Once you record a piano/violin duet on a tape, it is impossible to play it back as anything besides a piano/violin duet.

If the piano and violin parts are separately recorded in the sequencer of the CZ-5000, the violin can easily be changed to a flute or the piano to a guitar. After recording an ensemble with a variety of timbres, you can freely change any part that does not sound quite right to just the timbre you want.

## Real Time and Manual Recording

Two different data input methods can be used with the sequencer of the CZ-5000.

- a. Real time recording (Same as tape recorder)  
Recording of data as it is input using the keyboard.
- b. Manual recording (Only possible with sequencer)  
Note-by-note input as it is written on the sheet music.

Skilled keyboard players will usually use real time recording, but manual recording can come in handy when inputting rhythm patterns that call for precise timing.

The note capacity in real time recording is 3,500, while that for manual recording 7,000.

## Recording Tracks

It is impossible to do any actual recording unless you know something about recording tracks. Visualizing a cassette tape will help in grasping the concepts explained here.

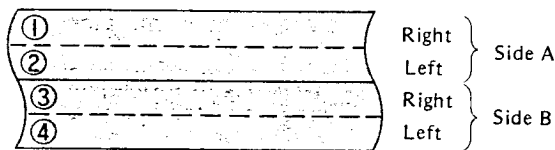

As illustrated in the diagram, a stereo cassette tape is divided into four sections. Each of these sections is called a track (or channel).

Tracks are individual, independent recording areas, so if only TRACK ① in the above illustration is played back, monophonic output of the side A right channel will occur.



# CZ-5000 Recording Tracks

As with a stereo cassette tape, the tracks of the sequencer of the CZ-5000 are capable of independent data storage. Usually, each component (melody, bass, chords, rhythm, etc.) that makes up the piece being recorded is input to a separate track. For example, the bass can be input to TRACK 1, the chords to TRACK 2, the melody to TRACK 3, etc. Then, playing back all of the tracks will automatically result in a piece that is complete with all of the component parts.



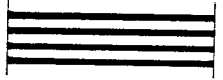

The sequencer of the CZ-5000 is equipped with 8 tracks, and each is fully capable of handling melody, bass or chords, but data input for real time recording is different from that of manual recording. Let's say we want to achieve the following arrangement:

Melody ..... 2 notes  
 Bass ..... 1 note  
 Chord ..... 4 notes

### A. REAL TIME RECORDING

Track	POLY value	Contents
Track 1	 2	Melody
Track 2	 1	Bass
Track 3	 4	Chord
Total		7

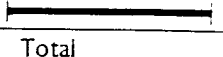
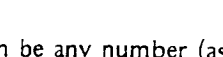
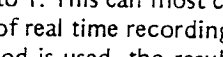
### B. MANUAL RECORDING

Track	POLY value	Contents
Track 1	 1	Melody
Track 2	 1	Melody
Track 3	 1	Bass
Track 4	 1	Chord
Track 5	 1	Chord
Track 6	 1	Chord
Track 7	 1	Chord
Total		7

As a quick comparison of A and B shows, the POLY value for each can be any number (as long as the cumulative total is less than 8) in A, while in B, the POLY value is limited to 1. This can most clearly be seen in the fact that all of the notes required for chords are input in TRACK 3 of real time recording, while TRACK 4 through 7 are required in manual recording. Whichever recording method is used, the result is 7-note polyphonic.

# Manipulating Recorded Data (Track Check)

It sometimes happens that once input of note data is complete the piece needs a little polishing to make it sound the way we want. For example, we may wish to make the melody, bass and chords to playback at different volume levels to make the melody stand out and the chords to become more subdued. Or we may even wish to change the timbre from that originally input for better effect.

The track check function if the CZ-5000 handles this type of recorded data manipulation. The timbre, volume and effects contained in each track can be changed freely to allow the player to find the best possible combination.

# "The Synthesizer Sound Seminar"

## 1 Sound

Every day, we hear a great variety of sounds. Voices, the noise of car engines, doors opening and closing, footsteps, rain . . . and music. In other words, we live our lives surrounded by sound. We can't see sound, so how can we describe it?

Physics tells us that "Sound is vibration". Taking the sound of a bell as an example, we will try to pursue the basics of sound as it is produced and as it is heard.

When kinetic (motive) energy is applied to a bell with a bell hammer as shown in figure 1, a "deformation" of the bell occurs causing energy to work trying to restore the bell to its original state. A periodic repetition of deformation and restoration commences. This is called vibration.

This vibration causes pressure changes in the air. These are called compressional waves. They are similar to the ripples that occurs when a stone is thrown into water.

These compressional waves are transmitted to the human ear where they cause the eardrum to vibrate. These vibrations are picked up by nerves so we hear them as "sound". If the vibrating body differs, so will the vibrations, meaning that we also hear a different kind of sound. Outer space, where there is no air, is a world altogether without sound.

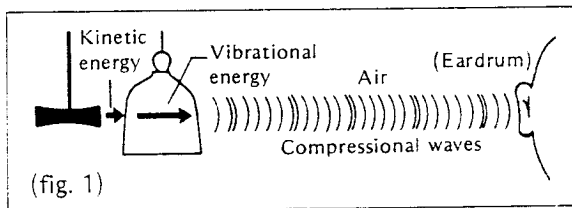

**Remember**

Sound is vibration of the air.

## 2 Wave Forms

### Seeing Sounds With Our Eyes

As explained above, sounds cannot actually be seen since they are vibrations of the air. However, you will often hear expressions such as "the wave form is different" or "this is almost a pure sine wave" concerning sounds. What is meant by "sound waves"?

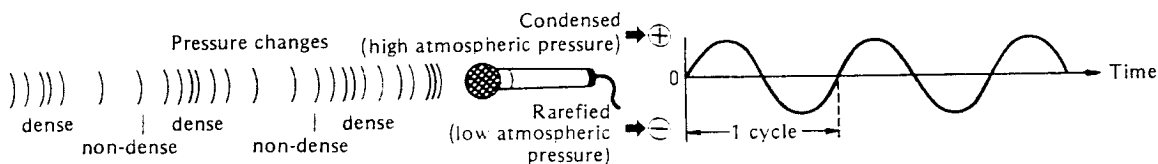

Let's consider the mechanism of a microphone which is used as a means for picking up sound. A microphone converts sound into electrical signals which can be then transmitted to an amplifier and speakers. As shown in the illustration, these electrical signals are simple conversions of the vibrations of the air (the changes in atmospheric pressure) into electrical  $\oplus$  and  $\ominus$ . When these changes are presented graphically, they can be interpreted as "wave and displays then as waveforms on a television screen. If we use this kind of a device, we can see sounds with our own eyes.

What we see are "waveforms". These waveforms differ greatly according to the sound and have various characteristics. These points will be explained later on in the Appendix.

**Remember**

If sounds are converted into electrical signals, they can be made visible as waveforms.

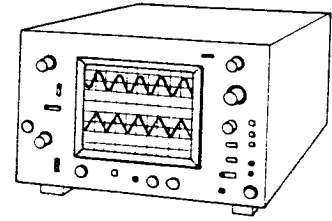

Oscilloscope

## 3 Three Basic Elements of Sound

We now know that sound is vibration and that these can be seen by the eye as waveforms. But we have been talking about "sound" in general up to now without taking into consideration that there are high sounds and low sounds, loud sounds and quiet sounds, mellow sounds and sharp sounds . . . that is to say a great variety of sounds which we perceive very differently. In general, sounds can be classified according to "pitch", "volume" and "tone quality", which are called the "three basic elements of sound". In other words, sounds are determined by these three basic elements.

**Remember**

The "three basic elements of sound" are "pitch", "volume" and "tone quality".

We can now have a look at how these three basic elements are connected with the various waveforms.

## 4 Pitch

### — The "first basic element of sound" —

When you hit the keys of a piano, you will notice that the sounds get higher the further to the right a key is located and lower the further to the left a key is located. This "altitude" of a sound is called "pitch". When sounds with differing pitches are compared on an oscilloscope, the number of waves per time unit differ. The higher a sound, the larger the number of waves; the lower a sound the smaller the number of waves.

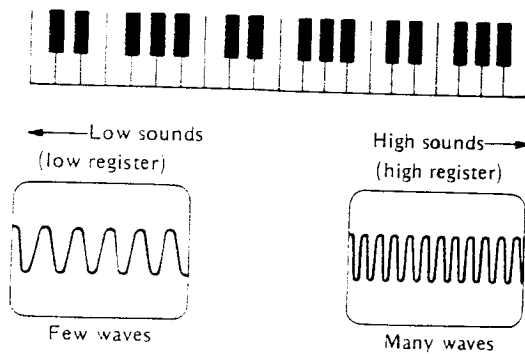

The number of waves is actually the number of the vibrations causing the sound. For example, if we are listening to a violin, it would be the number of vibrations of the strings within a certain period of time. The higher the sound the larger the number of vibrations per time unit; the lower the sound the smaller the number. The number of vibrations within the space of one second is generally called the frequency and expressed in units called Hz (Hertz). 100 Hz indicates that vibrations occur at the frequency of 100 times per second. The larger the number of Hertz, the higher the sound. Also note that doubling the frequency of a sound will raise it by one octave, so we can say that frequency and pitch are related logarithmically. The range of frequencies that can be heard by the human ear depends on the individual but is generally considered to be in the approximate range of 20 Hz to 20,000 Hz.

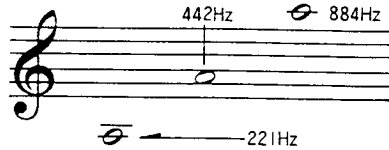

**Remember**

The pitch of a sound depends on the number of waves per time unit (the vibration frequency) and becomes higher as the frequency increases.

## 5 Sound Volume

### The "second basic element of sound"

If you hit a piano key forcefully, the sound will be loud. If you hit it softly, the sound will be soft. When viewed on an oscilloscope, this change in sound volume can be seen as a difference in the height of the waves. The height of the waves is called their amplitude. The larger the amplitude the louder the sound.

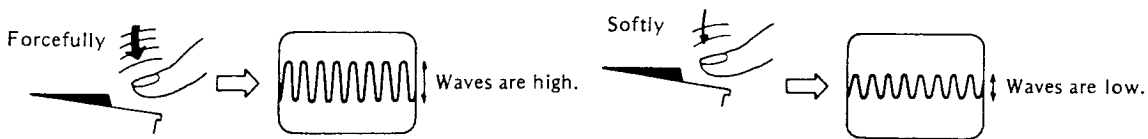

**NOTE**

The sound volume is determined by the amplitude (height of a wave) – the larger the amplitude the larger (louder) the volume.

6

Even if the same volume,

When so... selves di... waveform... waveform... and squa...

Wave



The CZ- as basic shown at

Re

The : wave



# 6 Tone Color or Timbre

## — The "third basic element of sound" —

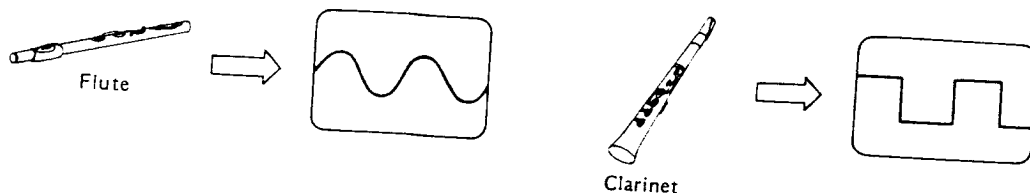
Even if you play a flute and a clarinet with the same pitch and about the same volume, you will not hear the same sound. That is because there is still one more distinguishing factor for sounds besides pitch and volume, known as "timbre".

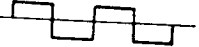

When sounds with different timbres are viewed on the oscilloscope, it can be seen that the waveforms themselves differ. It is this difference in waveform that causes the difference in timbre. Generally speaking, rounded waveforms result in softer timbres, while "pointed" waveforms result in hard, brilliant timbres. Very basically, waveforms can be divided into the three types shown in the diagram below – sine waves, saw-tooth waves and square waves.

Wave form	Name	Timbre	Instruments
	Sine wave	Soft	Flute, whistle
	Saw-tooth wave	Bright	Violin, trumpet
	Square wave	Simple	Clarinet, oboe

The CZ-5000 offers 8 basic waveforms. However, in order to understand the functioning of timbres as well as basic sound creation with the synthesizer, it is very important to first understand the three waveforms shown above.

### Remember

The timbre depends on the form of the wave. There are three basic waveforms – sine wave, saw-tooth wave and square wave.

## 7 Basic Waves and Harmonics—Shaping the Timbre

Now you would probably like to know how you can determine the shape of a wave (= timbre) in order to create the kind of sound you want. Have a look at the diagram on the lower left first. It illustrates the process of combining two sine waves to form a saw-tooth wave. B is the basic sine wave while C has twice the frequency of B (it is thus one octave higher in pitch) and only half its amplitude (volume). When B and C are combined, the result is the waveform A. A is still not a perfect saw-tooth shape, but it will infinitely approach a perfect saw-tooth shape if sine waves with triple (3x), quadruple (4x), quintuple (5x) etc. frequencies are added. If, on the other hand, only sine waves with odd numbered frequency multiples are added, the basic sine wave will gradually approach a square wave.

In this manner, any waveform can be created by adding a number of sine waves to a basic sine wave. Waves such as C with frequencies that are integral multiples of the frequency of the basic wave (in our case B) are called harmonics. In other words, the waveform and thus the timbre are determined by the kind of harmonics added to the basic sine wave. Put differently, almost all sounds with their different timbres that reach our ears include a variety of different harmonics, and it is these harmonics which are responsible for the countless characteristic timbres.

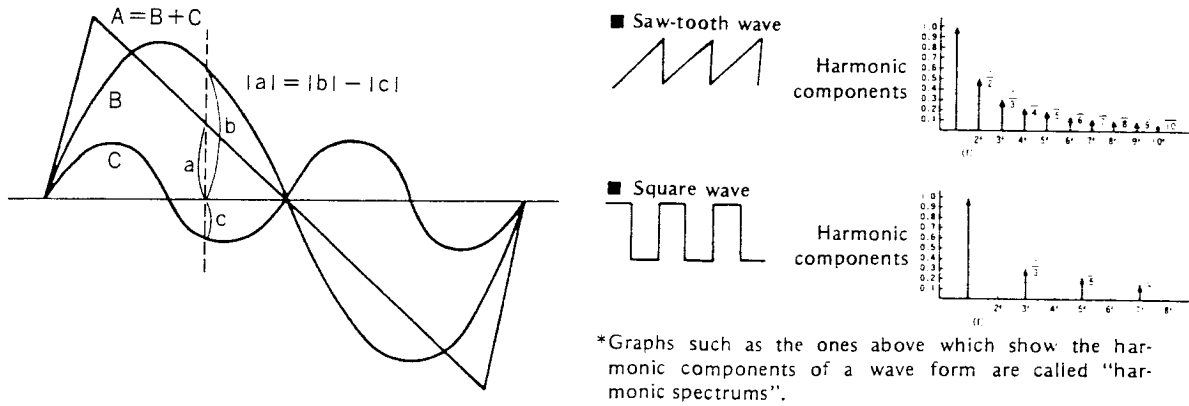

\*Graphs such as the ones above which show the harmonic components of a wave form are called "harmonic spectrums".

### NOTES

#### • Music and noise

Depending on its main kind of vibrations, sound is divided into "musical" and "noise". Sounds with regular vibrations (i.e. sounds in which components other than harmonics are very few) are considered to be musical, while sounds caused by complicated irregular vibrations (i.e. sounds with many components that are not harmonics) whose pitch can therefore not be measured are noise.

Most of the sounds used in music are of course musical sounds, but various kinds of noise such as that produced by percussion instruments are also used to heighten the musical effect.

#### • Pure Tones

Sounds which have no other components such as harmonics at all and consist of only one simple frequency are called pure tone. The wave form of a pure tone is always a perfect sine wave. The timbre of a tuning fork or the telephone time tone are almost pure tones (perfect sine waves), but a truly pure tone does not exist in the natural world. Pure tones, therefore, can only be created artificially (e.g. electronically).

### Remember

- Frequencies which are integral multiples of a basic wave with a certain frequency are called harmonics.
- The timbre (waveform) is determined by the harmonic components.



## 3 Envelopes

### — Other Factors Determining a Sound —

Besides the three basic elements of sound already explained, pitch, sound volume and timbre, there is another important factor which determines a sound. This is the variation of the sound over time. More precisely, it is the variation of each of the three elements over time from the beginning of the sound up to the point in time where it disappears completely. If a violin is played with a bow, for instance, the sound volume usually increases gradually while the timbre and pitch also change slightly. These changes over time are what determines the characteristic timbre of a violin. On the other hand, if the sound of a piano were to continue without decaying, it would be very difficult to distinguish it from the the sound of a flute. These variations over time are called envelopes. Envelopes expressed graphically such as those in the diagrams below are called envelope curves.

#### Envelope Curves of Various Instruments (Sound Volume)

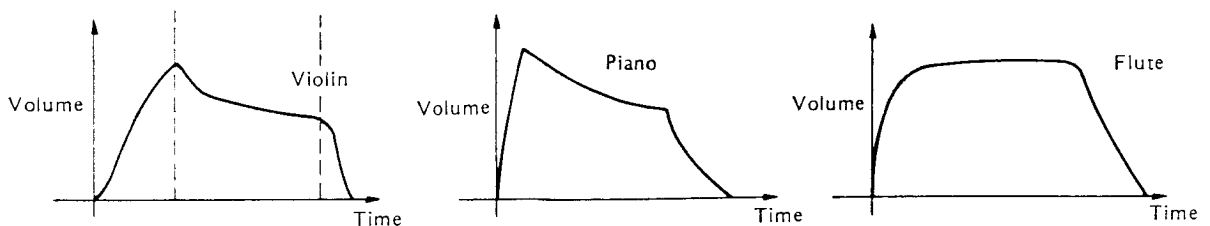

#### NOTE

The change of volume over time can also be called an envelope.

#### Remember

The changes over time of pitch, volume and timbre are called envelopes. Envelopes are among the most important factors determining a sound.

## 9 Basic Principles of Analog Synthesizer Structure

When people talk about synthesizers, you will often hear expressions such as VCO and VCF. Many who have heard such difficult words will therefore find it difficult to approach synthesizers, believing they are too complicated. Actually, though, synthesizers are not that difficult to understand at all.

Analog synthesizers in general consist of various blocks which correspond to the three major elements of sound and the envelopes explained above.

- **VCO (Voltage Controlled Oscillator)**

This circuit corresponds to determines the pitch of a sound by controlling voltage. This block is also used to create basic waveforms such as saw-tooth waves or square waves.

- **VCF (Voltage Controlled Filter)**

This circuit alters the timbre by accentuating or filtering out certain harmonics of the waveforms created by the VCO. The VCF might be called the most important part of an analog synthesizer.

- **VCA (Voltage Controlled Amplifier)**

This circuit controls the volume of the sound created by the VCO and VCF.

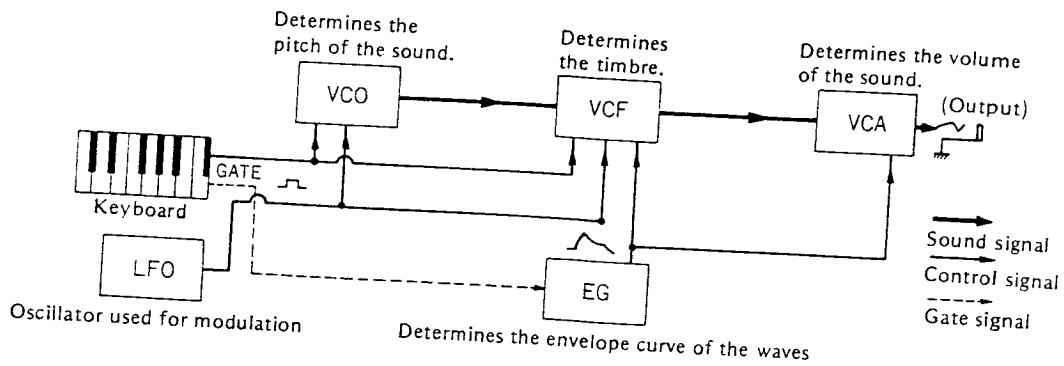

- **EG (Envelope Generator)**

Controls the change over time of the volume, timbre etc.; in other words the envelopes. The basic envelope curve consists of the four elements shown in the diagram below which can be controlled independently. The EG block is thus capable of creating a great variety of curves.

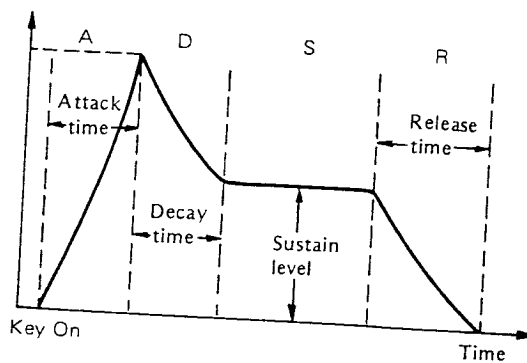

- **LFO (Low Frequency Oscillator)**

As this term indicates, the LFO is an oscillator operating at low frequencies. It can be used to control various other blocks to create such effects as vibrato.

**Remember**

The basic structure and functions of an analog synthesizer:

- **VCO:** Determines pitch (basic waveform)
- **VCF:** Creates the timbre
- **VCA:** Determines sound volume
- **EG:** Determines the envelope
- **LFO:** Used for various effects

**Note**

The above is meant only as a general idea of how an analog synthesizer works. Of course, there are considerable differences according to the manufacturer and model.

# 10 Structure of the CZ-5000

While the CZ-5000 is a digital synthesizer, it is as easy to understand as any analog synthesizer since it consists of blocks that correspond closely to those making up an analog synthesizer. Anybody who knows the basics concerning analog synthesis will therefore find it very easy to create any sounds they want with the CZ-5000. Even total beginners will be able to enjoy sound synthesis almost immediately by simply mastering the contents of this "Sound Synthesis Seminar".

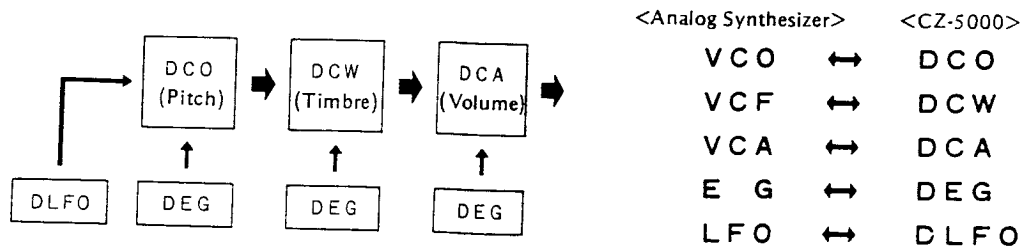

\* For more details on the structure of the CZ-5000, see Part 2, "CZ-5000 Sound Synthesis" (page 6).