

MASTER

COSMO SYNTHESIZER CZ-230S



OPERATION MANUAL 1
MANUAL DE OPERACION 51

CASIO 

COSMO SYNTHESIZER CZ-230S

Congratulations upon your selection of a CASIO CZ-230S. The CZ-230S is a state-of-the-art musical instrument which incorporates the latest electronics technology to make its operation as easy as possible. Exceptional sound quality backed up by a host of sophisticated features and functions makes the CZ-230S a joy to play for everyone. In order to enjoy the features and functions of the CZ-230S to their fullest, be sure to carefully read this manual and follow the instructions contained herein.

CONT

- **SUMM**
 - (1) FE/
 - (2) KE'
- **GENE**
 - (1) FRC
 - (2) RE/
 - (3) VOI
 - (4) TUI
- **POWE**
 - (1) DC
 - (2) AD.
 - (3) AU
 - (4) ME.
 - (5) FOI
 - (6) INIT
 - (7) INIT
- **PRESI**
- **PRESI**
- **RHYTI**
 - (1) FE/
 - (2) PAT
 - (3) PAT
 - (4) SOF
 - (5) SOF

CONTENTS

■ SUMMARY OF FEATURES	3	■ PITCH BEND	36
(1) FEATURES AND FUNCTIONS	3	■ PORTAMENTO	37
(2) KEYBOARD	4	■ TRANSPOSE	38
■ GENERAL GUIDE	5	■ SOLO FUNCTION	38
(1) FRONT PANEL	5	■ MT FUNCTION	39
(2) REAR PANEL	7	(1) SAVE	39
(3) VOLUME CONTROL	8	(2) VERIFY	40
(4) TUNING	8	(3) LOAD	41
■ POWER SUPPLY	9	■ MIDI	43
(1) DC POWER	9	(1) MIDI MESSAGE	43
(2) ADAPTORS	9	(2) POLY MODE/MONO MODE	44
(3) AUTO POWER OFF FUNCTION	10	(3) BASIC CHANNELS	44
(4) MEMORY BACK-UP	10	(4) INDIVIDUAL CHANNEL VOLUME SETTINGS	45
(5) FORCED POWER OFF	11	(5) PORTAMENTO ON/OFF	45
(6) INITIAL STATUS	11	(6) MIDI ON/OFF, CLOCK INT/EXT	46
(7) INITIALIZED MEMORY DATA	11	(7) SAMPLE CONFIGURATIONS	46
■ PRESET VOICES	12	■ CARE OF YOUR UNIT	47
■ PRESET RHYTHMS	14	■ SPECIFICATIONS	48
■ RHYTHM PROGRAMMING	16	■ PATTERN DIAGRAM	99
(1) FEATURES AND FUNCTIONS	16		
(2) PATTERN MEMORY	17		
(3) PATTERN PLAY	26		
(4) SONG MEMORY	28		
(5) SONG PLAY	34		

■ SUMMARY OF FEATURES

(1) FEATURES AND FUNCTIONS

The features and functions of the CZ-230S can be broadly divided into four major classifications.

① GENERAL

- 100 preset voices to choose from.
- 20 preset rhythms to match virtually any type of music.

② RHYTHM MODE

- Pattern memory mode for storage of up to 30 measures of rhythm patterns in memory.
- Pattern play mode for playback of stored rhythm patterns.
- Song memory mode for storage of compositions created by joining rhythm patterns together.
- Song play mode for playback of songs created using the song memory mode.

③ MT MODE

- Save function stores pattern and song rhythm data on cassette tape.
- Verify function confirms accuracy of data saved on cassette tape.
- Load function recalls data stored on cassette tape into the keyboard.

(2) KE

The CZ-230S has a number of interesting chords and functions.

• **Play with**
Selecting
ic, while 2
*All timbre

• **Program**
When PD s
PD lines fr
ic during r
used durin
*With rhyt
sources o
MAL MO

④ MIDI MODE

POLY MODE — Normal MIDI send/receive immediately after power is switched ON.

- Data send/receive capabilities of a polyphonic synthesizer (up to 8 notes).

MONO MODE — Special MIDI receive mode with 4 independent sound sources.

- Each channel can receive 4 channels of timbre data for the equivalent of four separate monophonic synthesizers.

(2) KEYBOARD

The CZ-230S has 49-key, 4-octave keyboard capable of producing chords of up to 8 notes (8-note polyphonic). However, the number of notes produced is affected by the timbre selected and functions applied as follows.

• Play without programmed rhythm playback

Selecting 1 DCO for a preset voice results in 8-note polyphonic, while 2 DCO results in 4-note polyphonic.

*All timbres become monophonic when the SOLO key is ON.

• Programmed rhythm playback

When PD sound source timbres are input to at least one of the PD lines from 1 through 3, the keyboard becomes monophonic during rhythm pattern playback. The keyboard cannot be used during rhythm pattern playback when line 4 is used.

*With rhythms programmed using the PCM rhythm sound sources only, the keyboard operated as noted for the NORMAL MODE during rhythm playback.

	MAXIMUM NUMBER OF NOTES		
	1 DCO TIMBRE (SOLO OFF)	2 DCO TIMBRE (SOLO OFF)	SOLO ON
① Normal status	8	4	1
② Playback of rhythm pattern with notes present in at least PD line from 1 through 3	1	1	1
③ Playback of rhythm pattern with notes present in PD line 4	0	0	0

NOTE

- The keyboard becomes monophonic when the unit is set to the MIDI MONO mode (see page 44).
- The term LOWER KEYBOARD (C₂ ~ F₃) as used in this manual is defined as the range of the keyboard which starts auto rhythm play when synchro start is set.
- The keyboard is used for setting note timing during rhythm pattern memory programming. It also loses its normal keyboard functions during the song memory modes.

- ① Pitch bend wheel
- ② Solo key
- ③ Portamento key
- ④ Tempo key
- ⑤ PCM volume
- ⑥ PD volume
- ⑦ Sound source selector
- ⑧ PD indicator
- ⑨ Rhythm mode selector
- ⑩ Preset 1 key
- ⑪ Preset 2 key
- ⑫ Program key
- ⑬ Display
- ⑭ MIDI CH key
- ⑮ Transpose key
- ⑯ Portamento time key
- ⑰ Bend range key
- ⑱ MT key
- ⑲ PD sound list (00 ~ 99)
- ⑳ Tuning control
- ㉑ Power switch
- ㉒ Power indicator
- ㉓ Main volume
- ㉔ Start/stop key
- ㉕ Tempo indicator
- ㉖ Synchro key
- ㉗ Intro/fill-in key
- ㉘ Rhythm selector
- ㉙ Value key
- ㉚ Ten-key pad
- ㉛ Cancel key
- ㉜ Speaker

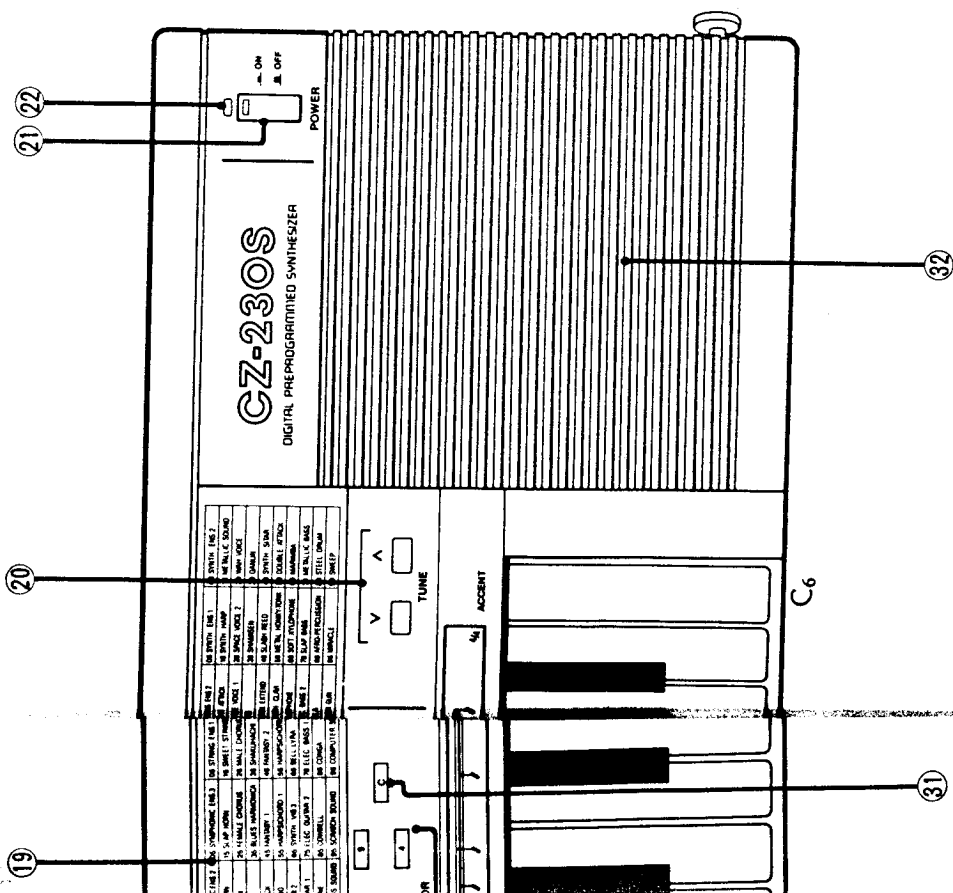

(2) REAR PANEL

See page 46 for details on the MIDI ON/OFF switch, and the MIDI CLOCK switch.

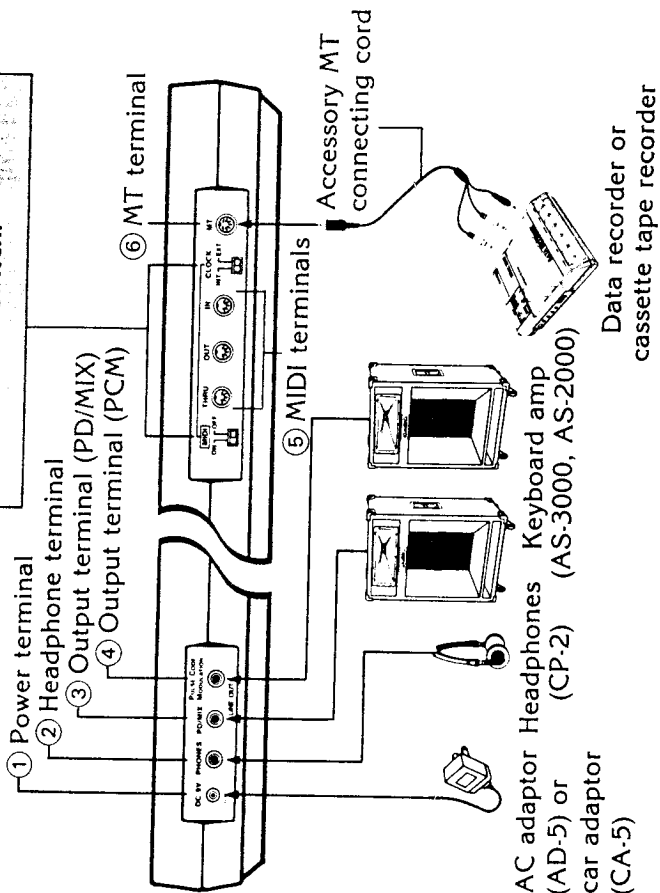

AC adaptor Headphones Keyboard amp (AD-5) or (CP-2) (AS-3000, AS-2000) car adaptor (CA-5)

① Power terminal (9V DC)

For connection of an optional AC adaptor (AD-5) or car adaptor (CA-5).

② PHONES (Headphone jack)

For connection of optional headphones (CP-2). Output from the speakers is automatically cut when headphones are connected.

③ PD/MIX ④ PCM (Output terminals)

For connection of an optional keyboard amplifier (AS series) or home audio system for better amplification of output. Connecting amplifiers to both the PD/MIX and PCM terminals outputs PD sound source timbres from PD/MIX and PCM sound source rhythms from PCM. Connecting only PD/MIX mixes and outputs both PD sound source timbres and PCM sound source rhythms.

⑤ MIDI terminals (IN/OUT/THRU)

For connection with another MIDI device.

⑥ MT terminal

For connection of a commercially available tape recorder or cassette tape recorder. This makes it possible to save pattern and song data on cassette tapes for later recall. Connections are made using the accessory MT connecting cord.

(3) VOICE

The CZ-2300 rhythms, patterns, and sources. Or control.

Keyboard volume

Program volume

Program volume

① VALUE

Press the MIDI VALUE button. The level can be holding down the button.

*Press only

MIDI CH disp

Hold down

(3) VOLUME CONTROL

The CZ-230S allows independent control of volume for preset rhythms, programmed rhythms, and programmed PD sound sources. Overall volume can be set using the main volume control.

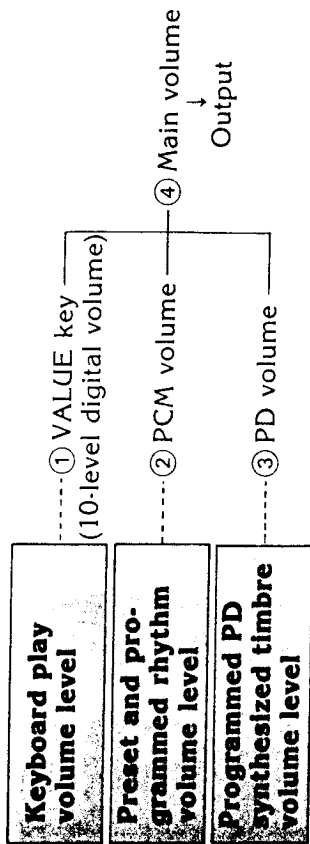

① VALUE KEY

Press the MIDI CH key twice and the display should appear as illustrated below to show the current volume level. The volume level can be adjusted using the VALUE V A keys while still holding down the MIDI CH key.

*Press only once if MIDI CH display is already shown.

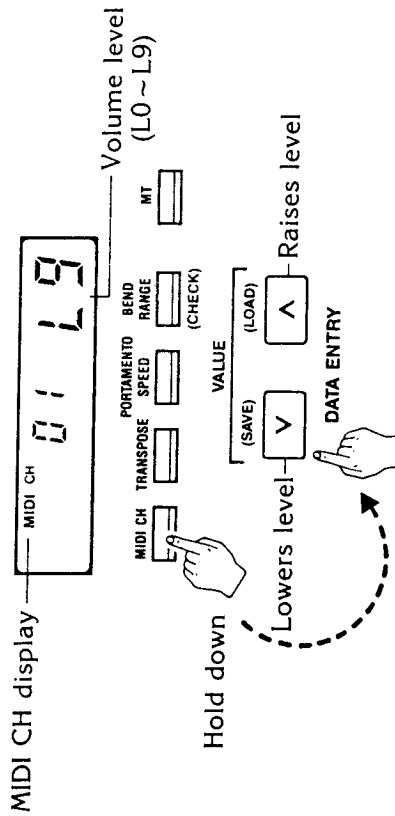

- The numeric value decreases by one with each press of VALUE V and increases by one with each press of VALUE A. Holding down either key causes high speed continuous change of the value.
- Volume level can be set to one of 10 levels in the range L0 (min) ~ L9 (max). Pressing the keyboard results in no output at all when volume is set to L0.
- Preset volume levels are retained even when the power of the unit is switched OFF.

② PCM VOLUME

Slides left and right to adjust the rhythm volume level.



③ PD VOLUME

Slides left and right to adjust programmed PD sound source timbre volume.

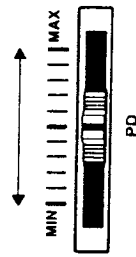

(4) TUNING

The overall pitch of the CZ-230S can be adjusted within the range of ± 100 cents (\pm half-tone). The standard setting for the keyboard is A4 = 442Hz, and each press of TUNING V lowers pitch, while pressing TUNING A raises pitch. Holding down either key causes high speed continuous change of pitch.

- Simultaneously pressing the TUNING V A keys automatically returns to the original value (A4 = 442Hz).

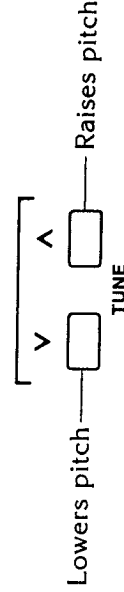

■ POWER SUPPLY

(1) DC POWER

• Dry cells

This unit can be powered by six D-size (SJM-1) manganese dry cells. Weakened batteries will result in lower volume or poor tonal quality. The power indicator will flash as battery power weakens. At this time, replace all 6 batteries as soon as possible.

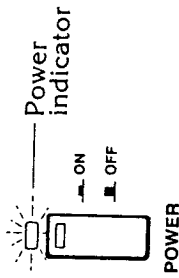

• Battery replacement

1. Slide open the battery compartment cover on the bottom of the unit and remove the weakened batteries.
2. Load a new set of batteries ensuring that polarity is correct.

*Replace all six batteries to ensure long battery life.

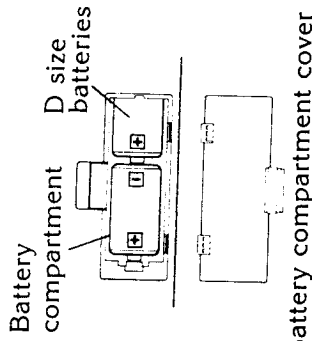

Perform the following initialization routine after loading batteries for the first time or if batteries are ever removed from the unit for longer than 10 minutes.

< Initialization routine >

Press the power switch to switch the power of the unit ON while holding down the CANCEL key.

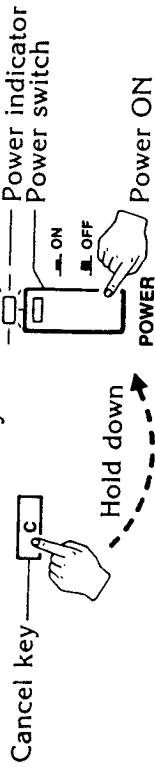

- The initialization routine is required to delete any bugs which may be generated within the memory during extended storage without batteries loaded.

Approximately 3.5 hours of battery life are provided by high performance (SJM-1) batteries. Battery life is extended to approximately 1 year if main power is supplied by household current (100, 117, 220, 240V AC) or a car battery, and batteries are used for memory back up only.

(2) ADAPTORS

< AC power >

An optional AD-5 AC adaptor is required to connect the unit to an AC outlet. The voltage rating of the adaptor (100, 117, 220, 240V) must match the power supply to which the unit is connected to avoid damage to internal circuitry. Batteries should also be loaded for memory back-up even when AC power is used for the main power supply.

< Car battery >

This unit can also be powered through an automobile's cigarette lighter by using an optional CA-5 car battery adaptor. Batteries should also be loaded for memory back-up even when car battery power is used for the main power supply.

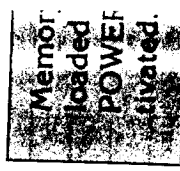
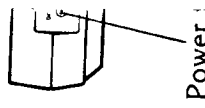

- Be sure to connect ac
- Remove b
- Use only t
- The adapt
- AC outlet.

(3) AUIT

An automa
6 minutes a
restored by s

<CZ-230S rear panel>

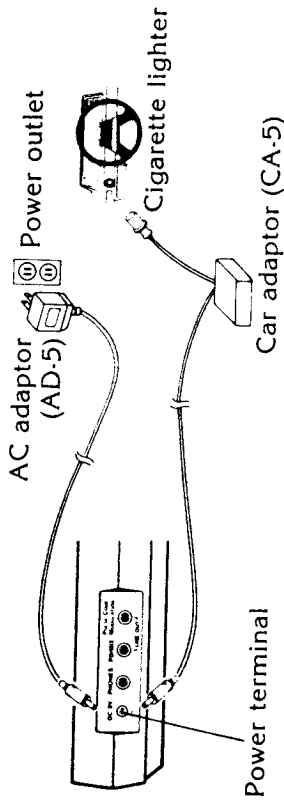

Memory back-up is not performed if batteries are not loaded when using adaptors. Therefore, the FORCED POWER OFF function mentioned below cannot be activated.

- Be sure to switch power OFF whenever connecting or disconnecting adaptors.
- Remove batteries when the unit is not used for extended periods to avoid damage caused by battery leakage.
- Use only the Casio AC adaptor specified for this unit. Using another type of adaptor can damage the unit.
- The adaptor normally becomes warm when connected to an AC outlet. Disconnect the adaptor whenever possible, especially if the unit is not used for extended periods.

(3) AUTO POWER OFF FUNCTION

An automatic power cut off function activates approximately 6 minutes after the last key operation. Power supply can be restored by switching the power switch OFF and then ON again.

- The auto power off function does not operate during MIDI receipt of external messages even though the keyboard or switches are not operated.

(4) MEMORY BACK-UP

- All memory data, including rhythm program patterns are retained by memory back-up batteries even when the main power supply is switched OFF. However, memory contents can be lost or altered if the batteries lose their power.
- Memory contents are retained even when batteries are removed for replacement and new batteries are loaded within 10 minutes.
 - The following data is retained by the back-up batteries when the main power is switched OFF:

- ① Programmed rhythm pattern (up to 30) data
*Including 4-line PD sound source timbres.
- ② Programmed song data (1 song of rhythm)
- ③ Portamento speed
- ④ Transpose
- ⑤ MIDI channel
- ⑥ MIDI MONO mode 4-channel timbres
- ⑦ Tuning
- ⑧ Internal 4-timbre data
- ⑨ Keyboard volume levels (digital volume values)
- ⑩ Tempo
- ⑪ Bend range

(5) FORCED POWER OFF

This function switches the main power supply OFF before battery power reduces to the point where memory data would be lost. Should this situation occur, replace the power supply batteries with a new set.

(6) INITIAL STATUS

The following is the initialized status of the unit when power is switched ON.

- ① **Power indicator lit**
*Blinking indicates weakened battery power.
- ② **Preset voice No. 00 (BRASS ENS 1) set**
- ③ **Rhythm stopped**
- ④ **Portamento and solo OFF**

All other data are set according to values in effect when power was switched OFF.

(7) INITIALIZED MEMORY DATA

The initialization routine outlined on page 9 sets the built-in memory data as shown below. Note that the initialization routine also deletes all rhythm pattern and song data from memory.

DATA TYPE	SETTING
Programmed rhythm pattern	Preset rhythm [1] pattern
Song	Preset rhythm [1] in series
Pattern memory PD sound source timbres	PD1 ~ 4 assigned to preset voice Nos.00 ~ 03
Portamento speed	30
Transpose	0 (C)
MIDI channel	01
MIDI MONO mode 4-channel timbre	No.00 timbre, all 4 channels
Tuning	A4 = 442Hz
Internal 4-timbre data	Sound Nos.96 ~ 99
Keyboard volume level	L9
Tempo	20 (J = 96)
Bend range	02

*All synthesized timbre patterns (PD1 ~ 4) are set to rests, and the key is set to C4.

PR

The CZ-23 by the PD

(1) PL

① Set the PATTE

② Switch

③ Use the
• Timbre n
the keyb

00 BRASS ENS 1
05 SYMPHONIC ENS.
10 LIGHT HARP
15 SLAP HORN
20 JAZZ ORGAN 1
25 FEMALE CHORUS
30 TRUMPET
35 BLUES HARMONIC
40 SYMTH. REED
45 FANTASY 1
50 PIANO 1
55 HARPSICHORD 1
60 BELLS
65 SYNTH. VIB.3*
70 ACC. GUITAR 1

PRESET VOICES

The CZ-230S features a total of 100 different voices produced by the PD sound source.

(1) PLAY

- Set the RHYTHM MODE selector to PATTERN PLAY.
- Switch the power of the unit ON.
- Use the ten-key pad to enter the desired timbre number.

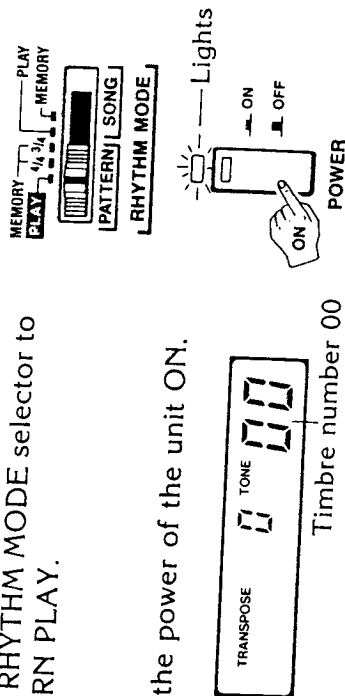

75 ELEC. GUITAR 2	76 ELEC. BASS 1	77 ELEC. BASS 2	78 SLAP BASS	79 METALLIC BASS
80 SYNTH. DRUMS 1 ▲	81 SYNTH. DRUMS 2 ▲	82 SYNTH. DRUMS 3 ▲	83 SYNTH. CLAPPER ▲	84 TAMBOURINE ▲
85 CONBELL	86 CONGA	87 TABLA ▲	88 AFRO-PERCUSSION *	89 STEEL DRUM
90 MOTORCYCLE ▲	91 JET ROAR ▲	92 EXPLOSION ▲	93 TYPHOON SOUND ▲	94 CAVERNIOUS SOUND
95 SCRATCH SOUND ▲	96 COMPUTER SOUND	97 LASER GUN	98 MIRACLE *	99 SWEEP

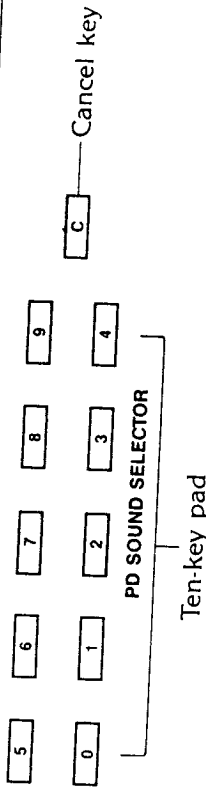

★ 8-note polyphonic. All others are 4-note polyphonic.
▲ indicates no fixed pitch.

< Example >

To call up No. 78 SLAP BASS, first press the **7** key. At this time the display should appear as illustrated below, and the present tone should not yet change.
* Mistakes can be cleared and the previous timbre can be reinstated by pressing the cancel key.

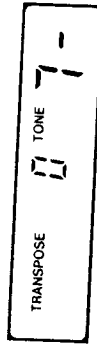

Now pressing the **8** key causes the value 78 to appear on the display and the timbre will be that which corresponds to the specified value (SLAP BASS).

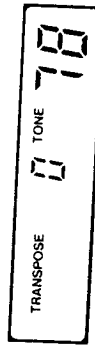

00 BRASS ENS. 1	01 BRASS ENS. 2	02 BRASS ENS. 3	03 SYMPHONIC ENS. 1	04 SYMPHONIC ENS. 2
05 SYMPHONIC ENS. 3	06 STRING ENS. 1	07 STRING ENS. 2	08 SYNTH. ENS. 1	09 SYNTH. ENS. 2
10 LIGHT HARP	11 MARS SOUND	12 SOUTHERN WING	13 MAGICAL WIND	14 FUNKY HORN
15 SLAP HORN	16 SWEET STRINGS *	17 LIGHT ATTACK	18 SYNTH. HARP *	19 METALLIC SOUND
20 JAZZ ORGAN 1	21 JAZZ ORGAN 2	22 PIPE ORGAN 1	23 PIPE ORGAN 2	24 ACCORDION
25 FEMALE CHORUS	26 MALE CHORUS	27 SPACE VOICE 1	28 SPACE VOICE 2	29 WAH VOICE
30 TRUMPET	31 FLUTE	32 WHISTLE *	33 VIOLIN *	34 CELLO
35 BLUES HARMONICA	36 SHAKUHACHI	37 KOTO	38 SHAMISEN	39 DANUN
40 SYNTH. REED	41 PEARL DROP	42 DOUBLE REED	43 MEOW ATTACK	44 SOFT ATTACK
45 FANTASY 1	46 FANTASY 2	47 PLUNK EXTEND	48 SLASH REED *	49 SYNTH. SITAR
50 PIANO 1	51 PIANO 2	52 PIANO 3	53 HONKYTONK PIANO	54 ELEC. PIANO
55 HARPSICHOORD 1	56 HARPSICHOORD 2	57 SYNTH. CLAVI	58 METAL HONKYTONK	59 DOUBLE ATTACK
60 BELLS	61 CARILLON	62 SYNTH. CELESTA	63 SYNTH. VIB. 1	64 SYNTH. VIB. 2
65 SYNTH. VIB. 3 *	66 BELL-LYRA	67 XYLOPHONE	68 SOFT XYLOPHONE	69 MARIMBA
70 ACC. GUITAR 1	71 ACC. GUITAR 2	72 SEMIACC. GUITAR	73 FEEDBACK	74 ELEC. GUITAR 1

(2) INTERNAL VOICES

Of the 100 preset voices, Nos. 96~99 can be rewritten with external MIDI data*. However, the initialization routine (see page 9) restores the timbres noted on the list to these voices.

*Timbre data can be stored to specified numbers by transmitting system exclusive messages from a personal computer to the keyboard MIDI terminal (see page 43).

PRES

The CZ-230S PCM sound producing a

(1) PRES

① Set the R/PATTERN

② Press the rhythm.

• Press PRES selectors an selectors.

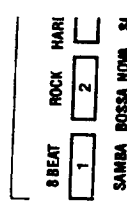

<Example>
To select the selector 6 SWING.

③ Pressing th rhythm.

PRESET RHYTHMS

The CZ-230S is equipped with 20 preset rhythms produced by PCM sound source. Each rhythm pattern is also capable of producing an intro pattern and fill-in pattern.

(1) PRESET RHYTHM

- ① Set the RHYTHM MODE selector to PATTERN PLAY.
 - ② Press the rhythm selector that corresponds to the desired rhythm.
- Press PRESET 1 to select the rhythms marked above the selectors and PRESET 2 for the rhythms marked below the selectors.

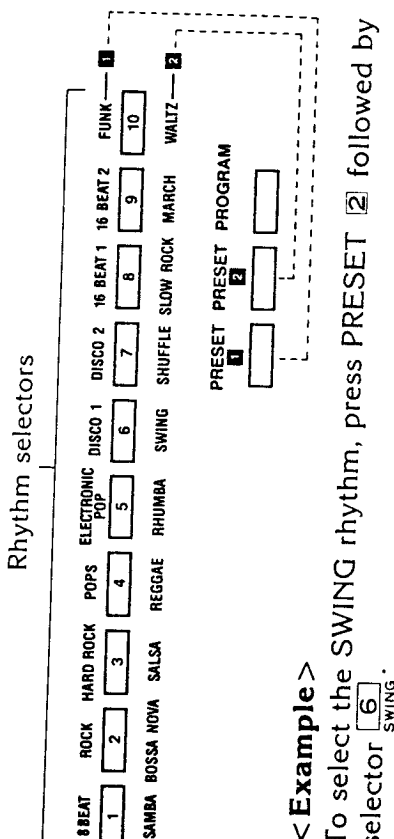

< Example >

- To select the SWING rhythm, press PRESET 2 followed by selector 6.
- ③ Pressing the START/STOP key begins play of the selected rhythm.

- While a rhythm is playing, the rhythm indicator flashes red for the first beat of each measure and green for each subsequent beat.
- Pressing the START/STOP key again stops rhythm play.

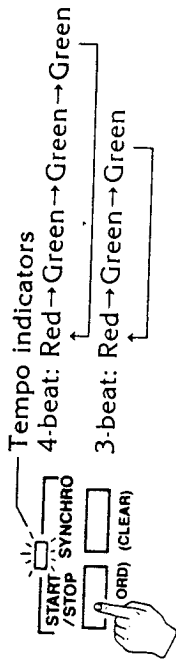

- ④ Adjust volume using the PCM volume control.

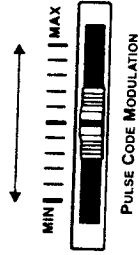

- ⑤ Adjust the rhythm tempo (speed) using the TEMPO V A keys.
- Each press of V decreases tempo while A increases tempo.

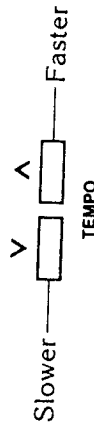

- The current tempo value appears on the display any time a TEMPO key is pressed. Holding down either TEMPO key causes high speed continuous change of the value. The TEMPO display is cleared when the TEMPO keys are released.



Tempo display (00 ~ 44)

- The tempo value is displayed in 45 steps within the range of 00 ~ 44. The following table provides the meaning of each value.

< **Example** >

A tempo value of 26 means $J = 120$ (120 beats/minute).

Display	Data $J = \text{beat}/\text{min.}$
00	40
01	42
02	44
03	46
04	48
05	50
06	52
07	54
08	56
09	58
10	60
11	63
12	66
13	69
14	72

Display	Data $J = \text{beat}/\text{min.}$
15	76
16	80
17	84
18	88
19	92
20	96
21	100
22	104
23	108
24	112
25	116
26	120
27	126
28	132
29	138

Display	Data $J = \text{beat}/\text{min.}$
30	144
31	152
32	160
33	168
34	176
35	184
36	192
37	200
38	208
39	216
40	224
41	232
42	240
43	248
44	256

- The selected tempo value is retained even when the power of the unit is switched OFF.

(2) SYNCHRO START

Pressing the SYNCHRO START key while rhythm is not playing causes the tempo indicator to flash green to indicate SYNCHRO START STAND BY. In this mode, the rhythm

accompaniment will begin as soon as a key on the LOWER KEYBOARD is pressed.

- Pressing the SYNCHRO START key during SYNCHRO START STAND BY cancels the stand by mode.

< SYNCHRO START STAND BY > < SYNCHRO START >
Tempo indicator (flashing green)

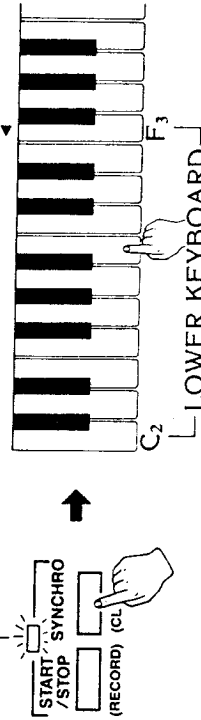

(3) INTRO/FILL-IN

Pressing the INTRO/FILL-IN key while rhythm is not playing sounds a 1-measure introduction pattern and then starts normal rhythm play. Pressing while rhythm is playing causes a fill-in pattern to play that continues to the end of the current measure.

- Holding down the INTRO/FILL-IN key caused the fill-in pattern to continue until the end of the measure in which the key is released.
- Normal play always resumes from the first beat of the first measure of the normal pattern when the fill-in is complete.

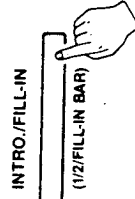

NOTE

The rhythm START/STOP key is inoperative whenever the MIDI ON/OFF switch on the rear panel is set to ON and the CLOCK switch is set to EXT.

The CZ-2 tion that drum, sn preset voi tern. This sequence

(1) FE

Programn and then j ty of the t a 199-bar

① 30 pa

Three me the 10 rh

② 16 so

12 PCM rh add up to programr

③ 1/12-b

The minin is one thir ber of note 16.

④ Keybo

The 48 ke; indicate th

the LOWER
RO START

ART >

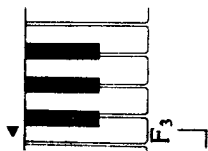

not playing
starts nor-
causes a fill-
the current

fill-in pat-
which the key

FILL-IN

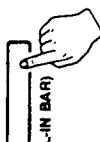

enever
t to ON

RHYTHM PROGRAMMING

The CZ-230S is equipped with a rhythm programming function that provides 12 PCM rhythm sources to produce bass drum, snare drum, and other effects. Up to four of the 100 preset voices can be used to program a 4-line multi-track pattern. This means that the CZ-230S is equivalent to a 4-track sequencer with drum machine.

(1) FEATURES AND FUNCTIONS

Programming consists of creating a number of rhythm patterns and then joining them together into a single song. The capacity of the unit allows storage of up to 30 rhythm patterns and a 199-bar song program.

① 30 patterns

Three measures of a rhythm pattern can be stored to each of the 10 rhythm selectors (~).

② 16 sound sources

12 PCM rhythm sound sources and 4 PD sound source timbres add up to a total of 16 sound sources available for pattern programming.

③ 1/12-beat minimum note value

The minimum programmable note value is 1/12-beat, which is one third of a 16th note (♩). However, the maximum number of notes input for a single sound source per measure is only 16.

④ Keyboard input for programming

The 48 keys on the keyboard from C_2 through B_5 are used to indicate the timing of each note as indicated below.

(Triplicate 8th notes)
(16th notes)



*The white key on the extreme right of the keyboard (C_6) acts as an accent key.

⑤ Accenting

Pressing the ACCENT key simultaneously with timing input on the keyboard applies an accent to the note played.

⑥ 8-note polyphonic

Up to 4 PCM rhythm tones and 4 PD sound source timbres can be produced simultaneously.

*PCM rhythm sound sources are divided into 4 groups of 3 effects each. No two effects from the same group can be produced simultaneously. Only one effect can be produced from the same group at any one time.

GROUP A: BD (bass drum), LT (low tom), LB (low bongo)

GROUP B: SD (snare drum), HT (high tom), HB (high bongo)

GROUP C: CH (closed hi hat), OH (open hi hat), RIDE (ride cymbal)

GROUP D: RIM (rim shot), CB (cow bell), CLAPS (hand claps)

*Only monophonic tones can be input to each of the 4 lines of the PD sound source.

⑦ Two types of beats

Patterns can be programmed in either 4/4 time or 3/4 time.

⑧ 199 song steps

Songs up to 199 steps long can be programmed and stored (1 step = 1 measure).

(2) PATTERN MEMORY

MODE SETTING

- Press the PROGRAM key.
- Rhythm programming cannot be performed if PRESET 1 or PRESET 2 are selected.

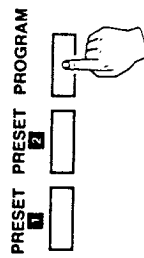

- Set the RHYTHM MODE selector to PATTERN MEMORY. This enters what is defined as PATTERN MEMORY STAND BY.

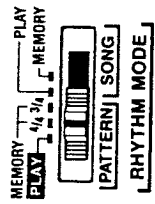

- At this time also select either 4/4 or 3/4 for the rhythm to be programmed.

< Display >

4 displayed for 4/4 time
(3 for 3/4 time)

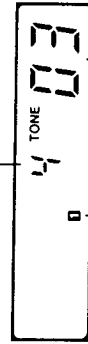

1 BAR (1st measure) Timbre number

- If either PRESET 1 or PRESET 2 is selected, the display will flash at this point to indicate that input cannot be performed. In this case, press the PROGRAM key to clear the flashing display and to enter PATTERN MEMORY STAND BY.

PROGRAM AND MEASURE NUMBER SELECTION

- Use the rhythm selectors to choose a program number.
- Up to three measures can be programmed for each program numbers (1 ~ 10).

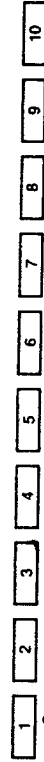

- Use the INTRO/FILL-IN key to select the measure number.

- The initial value for this selection is the first measure (1 BAR). Each press of the INTRO/FILL-IN key changes the selected measure in the following order and shows it on the display: 1 BAR → 2 BAR → 3 BAR → 4 BAR → ...

- Select either [

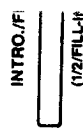

CLEARING

- Press the STA the SYNCHRC of the measur the RECORD measure.



NOTE

- Pressing the k a note accordi responding to
- The single mea

4/4 time
e)

number

the display
not be per-
clear the
TAND BY.

number.
with program

10

re
re (1 BAR).
selected
the display:

- Select either [1] BAR, [2] BAR or [F] BAR.

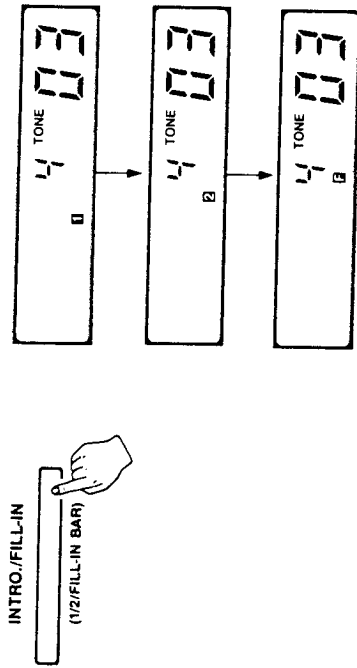

CLEARING A SINGLE MEASURE

- ⑤ Press the START/STOP (RECORD) key while holding down the SYNCHRO (CLEAR) key to clear the existing contents of the measure selected in step ④. This process also enters the RECORD mode to allow new input for the selected measure.

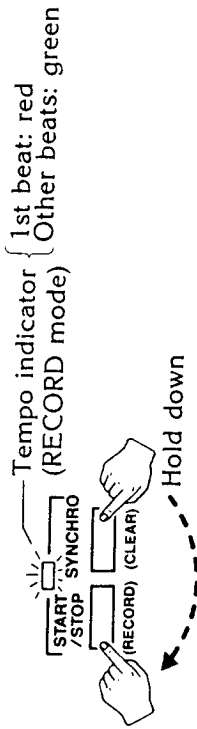

NOTE INPUT

- ⑥ Pressing the keyboard while in the RECORD mode inputs a note according to the specified timing in the timbre corresponding to the timbre selected.
- The single measure clear operation outlined in 5 automati-

cally enters the RECORD mode. While the tempo indicator is OFF and the unit is in PATTERN MEMORY STAND BY, the keyboard will produce the selected timbre, but notes cannot be input. Press the START/STOP (RECORD) key to enter the RECORD mode to allow note input.

- Pressing the START/STOP (RECORD) key before performing the single measure clear operation results in repeat playback of any data already in memory. In this mode, timing can be set using the keyboard and new notes can be added to the previous contents.

- ⑦ Press the START/STOP (RECORD) key again to exit the RECORD mode and complete note input.

NOTE INPUT OPERATIONAL PROCEDURE

The following presents an actual sample procedure using simple musical notation. The PD sound source programming almost identical to that of the PCM rhythm sound source, except for the addition of pitch input. This example will use 4 PCM rhythm sound sources for the rhythm pattern plus line 1 of the PD sound source to add a bass phrase to form a 1-measure pattern.

BEAT = 4/4: Set the RHYTHM MODE selector to "PATTERN MEMORY 4/4".

< NOTATION >

board
key

snare

an be

trated
perim-



⑥ Set the RHYTHM SOUND SOURCE selector to CH (closed high hat).

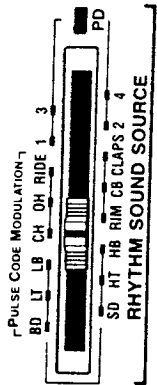

⑦ Use the keyboard keys to input the CH notes as illustrated below. The BD, SD, and CH patterns will be played back, superimposed within the same measure.

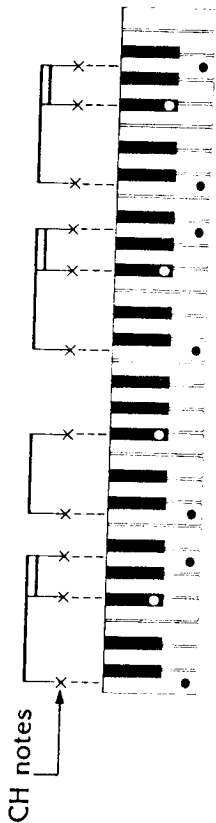

⑧ Set the RHYTHM SOUND SOURCE selector to OH (open hi hat).

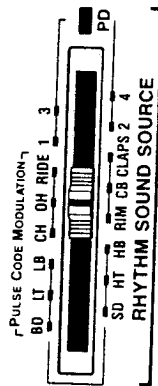

⑨ Use the keyboard keys to input the OH notes as illustrated below. The BD, SD, CH, and OH patterns will be played back, superimposed within the same measure.

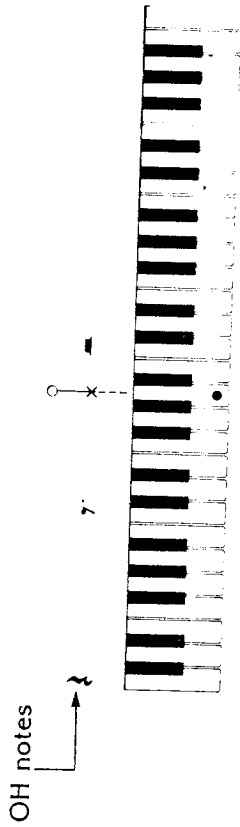

⑩ Set the RHYTHM SOUND SOURCE selector to PD-1.

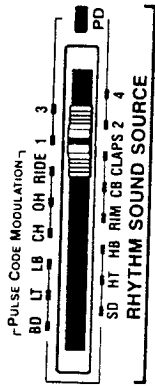

⑪ Use the ten-key pad to select No.78 (SLAP BASS). The number of the currently selected timbre is shown on the display.

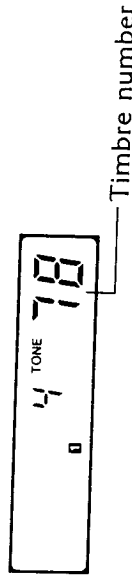

• Timbre number selection can be performed either during recording or while rhythm is not being played. One timbre can be specified per line.

- ⑫ Press the START/STOP (RECORD) key to suspend the RECORD mode.



- ⑬ Press E₂ on the keyboard which is the value of the first bass note. If the wrong key is pressed, simply press the correct key to change the note. The note corresponding to the last key pressed is stored in memory.



- ⑭ Press the START/STOP (RECORD) key to reenter the RECORD mode, and any part of the pattern input up to this point will begin to play back.

- ⑮ Use the keyboard keys to input the bass notes as illustrated below. In this particular example, all the bass notes are the same and can all be input at this step.

- The sound source selector PD indicator lights as soon as notes are input.

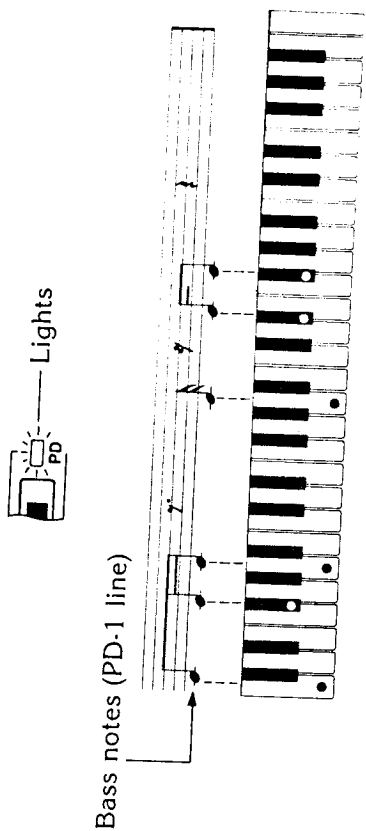

- During PD sound source note input, rests can also be inserted between notes. In the input procedure outlined above, rests were not included, so notes end up being linked with each other. Use the keyboard keys to input the rests while holding down the [C] (CANCEL) key.

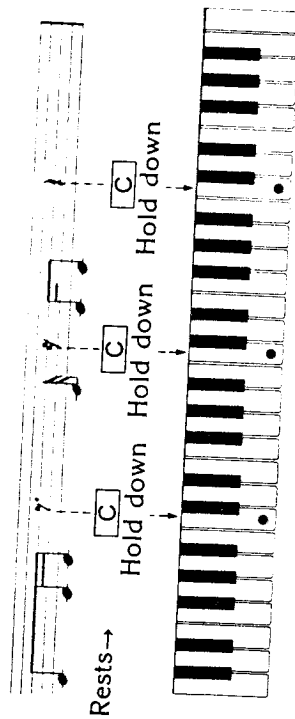

- ⑯ Press the START/STOP (RECORD) key to exit the RECORD mode and stop playback.

▶▶▶

- ① **CHAN**
Inputting a character is accomplished by ample each of the RECOF keyboard, 1 note is spe



- ② **RE**
stc
F4
③ **RE**
sta
④ **Tir**

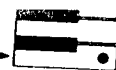

- ② **CHANG**
Once input RHYTHM SO PD-2 for input steps performed for recording.
• The input li can be char

PATTERN MEMORY APPLICATIONS

① CHANGING PITCH

Inputting different pitches on the same PD sound source line is accomplished by performing steps 12 through 15 in the example each time a new pitch is input. With each change of pitch, the RECORD mode is stopped, a new pitch is specified on the keyboard, the RECORD mode is resumed, and the value of the note is specified.

② CHANGING LINES

Once input to line 1 of the PD sound source (PD-1), the RHYTHM SOUND SOURCE selector setting can be changed to PD-2 for input using a different timbre. The procedure is identical to steps 10 through 15 in the example. Input can also be performed for lines 3 and 4 to result in 4-track multi-channel recording.

- The input line (RHYTHM SOUND SOURCE selector) setting can be changed while still in the RECORD mode.

- The line selection sequence for input really does not matter, but it is suggested that lines be used in the order of 1, 2, 3, 4 to avoid later confusion.

③ CHANGING TIMBRES

The currently selected timbre can be changed as many times as desired, even during the RECORD mode. The new timbre is in effect as soon as a 2-digit value is entered using the ten-key pad. The notes already input are played in the new timbre when the new value is input.

- Only one timbre can be specified per line. A different timbre cannot be specified within a measure for the same line.
- The currently selected timbre cannot be changed when the RHYTHM SOUND SOURCE selector is set to any of the PCM rhythm settings.

④ CHANGING MEASURES

Each press of the INTRO/FILL-IN key changes the selected measure during recording or while rhythm is not being played in the following order and shows it on the display:

[1] BAR → [2] BAR → [F] BAR → [1] BAR → ...

Any notes currently stored in a measure are played back when the measure is selected in the RECORD mode.

- Notes can be input to an existing pattern as it is playing back, or the entire measure can be cleared (see page 18 ⑤).
- Repeating the operation noted above makes it possible to record three measures ([1] BAR, [2] BAR, [F] BAR) for each program number (rhythm selector).

⑤ CHANGING PROGRAM NUMBERS

The program number can be changed by pressing a rhythm selector during the RECORD or RECORD STAND BY mode. Doing this in the RECORD mode changes to the new program number but retains the original measure number specification. At this time, any notes previously existing under the selected program are played back.

< SUMMARY >

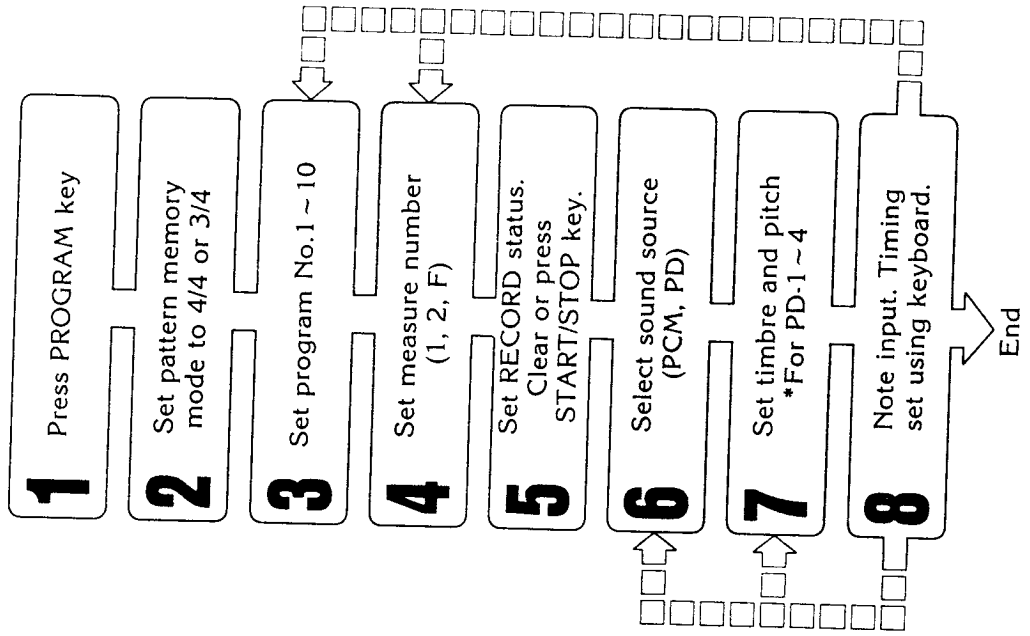

NOTE

- A maximum of 17 notes can be added to the pattern.
- The pattern memory mode of the Pi...
- The pattern memory mode of the sa...

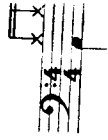

- *In the example, the pattern memory mode is added for the Pi...
- *The following pattern memory mode is added to exceed the 17th note...

- A pattern memory mode is selected at this time, the pattern memory mode is no function...

NOTE

• A maximum of 16 notes can be input for each PCM rhythm in each measure. This is also true of each line of the PD sound source. Therefore, if all the notes are of the same value, the lowest value is the 16th note (♪).

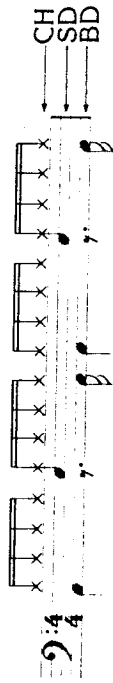

- In the example shown above, no more notes can be added for the OH (open high hat) line.
- The following display appears when an attempt is made to exceed the maximum of 16 notes. This display remains while the key for the 17th note is pressed and disappears when the key is released. Of course, the 17th note is not stored in memory.

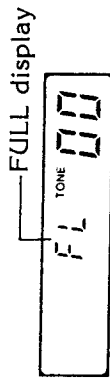

- A pattern can be entered in 3/4 time when the RHYTHM MODE selector is set to PATTERN MEMORY 3/4. At this time, the note value input keyboard becomes the range from C₂ through B₄, with C₅ through B₅ having no function at all.

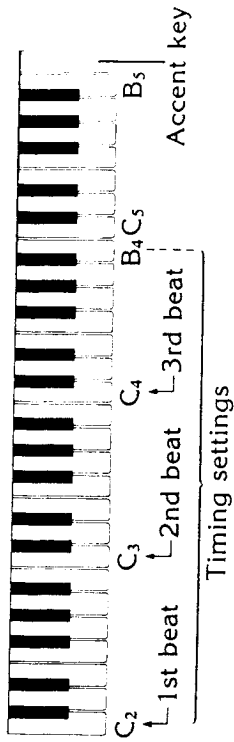

- Playing back a pattern recorded in 4/4 time while PATTERN MEMORY 3/4 is set results in the 4th beat of each measure being cut off. Conversely, playing back a pattern recorded in 3/4 time while PATTERN MEMORY 4/4 is set results in a rest being inserted for the 4th beat of each measure.
- Either 4/4 time or 3/4 time patterns can be programmed for any measure, and different times can even be programmed for two measures under the same program number.

- Changing the setting of the RHYTHM MODE selector causes playback operations to stop. Pressing the PRESET 1 or PRESET 2 key during record operations cancels the RECORD mode.

- An accented note (see page 16) already existing in memory can be changed to an unaccented note by pressing the corresponding timing key (on the keyboard) twice.

• Any one of the three following methods can be used to delete notes from each sound source or line in a pattern.

- ① Press the keyboard keys in the RECORD mode that correspond to the timing of the note to be deleted.
- ② Press the SYNCHRO (CLEAR) key in the RECORD mode to delete all notes for the currently selected sound source or line.
- ③ Hold down the SYNCHRO (CLEAR) key while the RHYTHM MODE selector is set to PATTERN MEMORY and press the START/STOP (RECORD) key to delete all sound source and line data from the currently selected measure.

• 12 PCM rhythms and 4 PD sound sources can be used in pattern programming, but certain PCM rhythms cannot be produced simultaneously (see page 16). If two rhythms from the same group are specified, that which is specified last takes priority.

• For PD sound source timbres, recorded pitches can be replaced by pressing the appropriate keyboard (timing) key twice. The first press deletes the existing note, while the second press inputs the new note.

• The number of rests that can be included in a single measure depends upon the number of notes input. Since a measure can hold a maximum of 16 notes, a measure which already contains 10 notes can have 6 rests. The timing of rests is limited to the following locations:

- ① Between notes (rests cannot be included in measures that include no input)
- ② Between the beginning of a measure and a note
- ③ Between a note and the end of a measure
- ④ Between the beginning and the end of a measure for a specific line

One rest can be included at each of the locations noted above. Condition 3, for example, can be used in pattern or song playback to prevent the last note of one measure from continuing into the next measure during playback.

• Rest data is deleted whenever note data immediately preceding the rest is deleted. Inputting a note where a rest has already been specified replaces the rest with the input note.

• PATTERN PLAY repeatedly plays back the rhythm patterns in the order 1 BAR → 2 BAR, and plays the F BAR when the INTRO/FILL-IN key is pressed. Up to 30 measures of patterns can be joined together for song play. The keyboard is 4-note polyphonic when no notes at all are input in the 4 lines of the PD sound source. If even one line of PD line 1 ~ 3 contains note data, however, the keyboard becomes monophonic. Note data input to the PD-4 line makes the keyboard inoperative during pattern playback. Only input pattern data to PD lines 1 ~ 3 if you wish to play along on the keyboard with the pattern playback.

• The same source line lines 1 through 4, the pattern is 1
* A rest must be entered in the fourth line of the song.

* Always inputting use of

• A slight difference

(Fig. 1)

JAZZ ORGAN

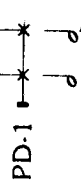

• The same timbre can be set for three of the PD sound source lines. In this case, the timbre should be set to lines 1 through 3. If the fourth line is used for the same timbre, the following points should be noted when the pattern is programmed.

* A rest must always be included in the measure (pattern) immediately preceding use of the fourth line when the fourth line is not used until some point within a song.

* Always input a rest in measures immediately preceding use of line 4 that contain no notes for line 4.

• A slight break always occurs when changing between two different timbres in the same line.

(Fig. 1)

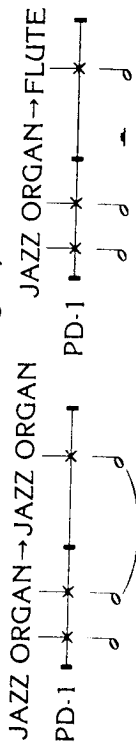

(Fig. 2)

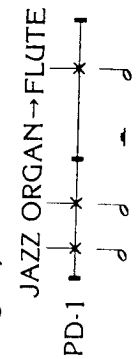

(3) PATTERN PLAY

MODE SETTING

- ① Press the PROGRAM key.
- Program pattern playback cannot be performed if PRESET ① or PRESET ② are selected.

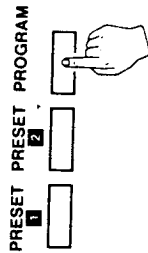

- ② Set the RHYTHM MODE selector to PLAY.

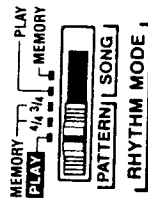

PROGRAM NUMBER SELECTION AND PLAYBACK

- ③ Press the rhythm selector that corresponds to the program to be played back.

• Each selector can hold up to 3 measures of patterns ([1] ~ [10]).

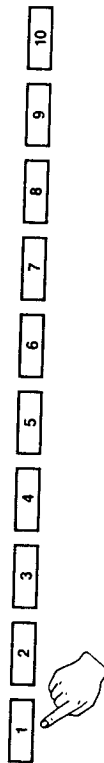

- ④ Press the START/STOP key to begin repeat playback of the rhythm pattern (1 BAR → 2 BAR).

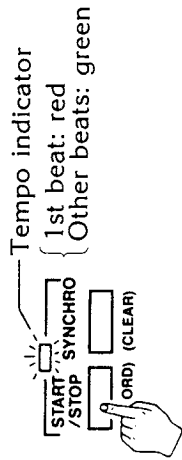

- ⑤ Pressing the INTRO/FILL-IN key switches to the F BAR pattern. After the fill-in pattern, playback returns to 1 BAR → 2 BAR.

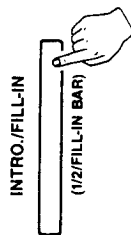

- Holding down the INTRO/FILL-IN key caused the fill-in pattern to continue until the end of the measure in which the key is released.

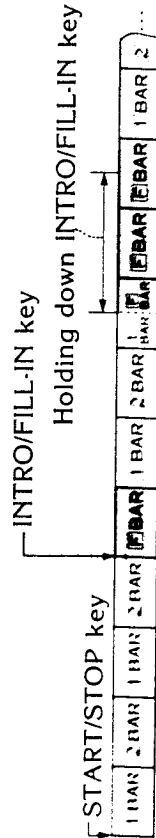

- Pressing a rhythm selector switches to the newly specified program number but maintains the present measure number setting.
- ⑥ Pressing the START/STOP key again terminates playback at that point.

SYNCHRO START AND INTRO PATTERN

< SYNCHRO START >

Pressing the SYNCHRO START key while rhythm is not playing causes the tempo indicator to flash green to indicate SYNCHRO START STAND BY. In this mode, the rhythm accompaniment will begin as soon as a key on the LOWER KEYBOARD is pressed.

- Pressing the SYNCHRO START key during SYNCHRO START STAND BY cancels the stand by mode.

SYNCHRO START STAND BY

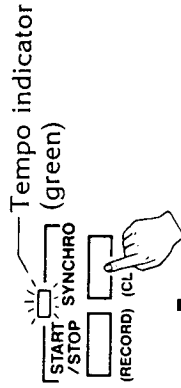

SYNCHRO START

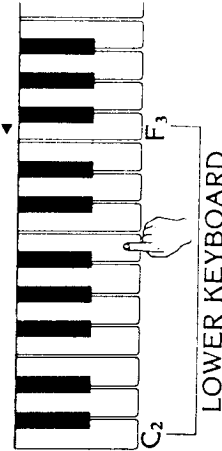

< INTRO PATTERN >

Pressing the INTRO/FILL-IN key while rhythm is not playing sounds a 1-measure introduction pattern and then starts normal rhythm play using the specified program number.

- The intro pattern for pattern play is different from that for preset rhythms. The first beat is always CH (closed high hat) no matter what the program number.

NOTE

- The di...
- The tir played timbre when n 3 only) timbre

• " -- " is which r the key

(4) SON

SON

- ① Press the terms to c

NOTE

- The display appears as illustrated during playback.
- * The timbre available for 4-note polyphonic play is displayed when notes are not present in the PD line. The timbre displayed can be used for monophonic play when notes are present in 1 or more lines (1 through 3 only). The ten-key pad can be used to change the timbre number during playback.

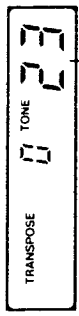

Number of timbre assigned to keyboard

*"--" is displayed during playback of a pattern for which note data is included in PD-4 to indicate that the keyboard is inoperative.

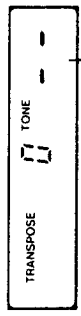

No keyboard play

(4) SONG MEMORY

SONG MEMORY MODE SETTING

- Press the PROGRAM key (when using preprogrammed patterns to create a song).

- Press PERSET [1] or PRESET [2] when using preset rhythm patterns to create a song.
- The PRESET [1], PRESET [2] and PROGRAM keys can also be used during recording.

② Set the RHYTHM MODE selector to SONG MEMORY.

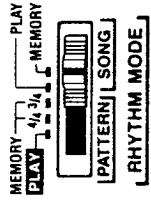

- The display should now appear as illustrated to indicate the number of steps. The initial value is always 00.

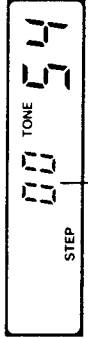

Step number (00 ~ 199)

SONG ALL CLEAR

- Press the START/STOP (RECORD) key while holding down the SYNCHRO (CLEAR) key. This operation clears all previous contents of the song memory and automatically enters the RECORD mode for programming of a new song. Also at this time, the selected program number (or preset rhythm) begins repeat play from [1] BAR.

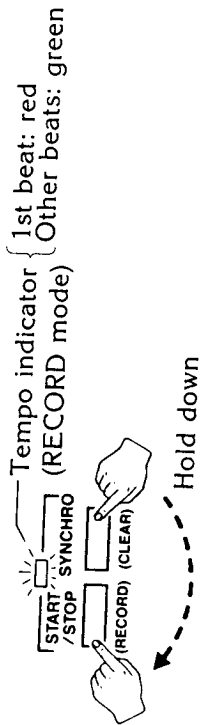

- The display should show STEP 1 to indicate the first step.

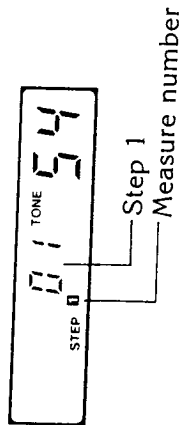

PATTERN SELECTION

- ④ Rhythm selectors are used to select a program number (or preset phythm), while the INTRO/FILL-IN key is used to select the measure.
- The selected pattern measure number is shown on the display, and the selected pattern is repeatedly played back.
- The specified measure number is not changed even if a different program number (or preset rhythm) is selected.

< Example >

- ① Program No.5, [1] BAR selected
- ② Switch to Program No.2. Playback switches to Program No.2, [1] BAR, and the display does not change.
- ③ Change the measure to [2] BAR. Playback switches to Program No.2, [2] BAR, and display changes as illustrated.

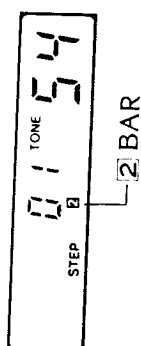
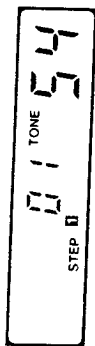
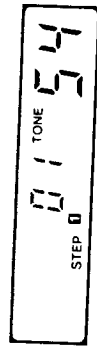

SONG STEP INPUT

- ⑤ Pressing the START/STOP (RECORD) key while in the song RECORD mode inputs the currently selected pattern as one step. At this time, the unit automatically advances to the next step for recording and the display shows the next step number.
- Repeating steps ④ and ⑤ above makes it possible to link a series of rhythm measures into a song.

< Example > Create a song as illustrated below:

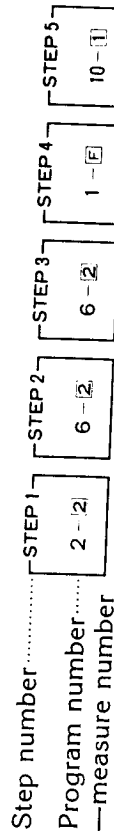

- ① Press R [2] and the INTRC

Then pres key to inp

- ② Press RH [6]. Ther STOP key

- ③ Press the again to inp STEP 3 als

- ④ Press RHY [1] and us IN key to se

Then press key to input

① Press RHYTHM SELECTOR [2] and select [2] BAR using the INTRO/FILL-IN key.

Then press the START/STOP key to input STEP 1.

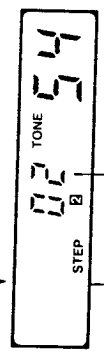
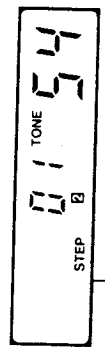

STEP 2

② Press RHYTHM SELECTOR [6]. Then press the START/STOP key to input STEP 2.

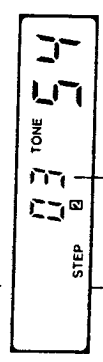

STEP 3

③ Press the START/STOP key again to input pattern 6-2 into STEP 3 also.

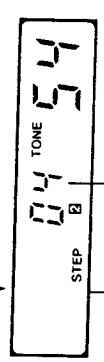

STEP 4

④ Press RHYTHM SELECTOR [1] and use the INTRO/FILL-IN key to select [F] BAR.

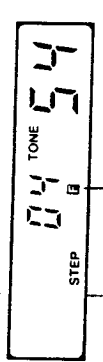

[F] BAR

Then press the START/STOP key to input STEP 4.

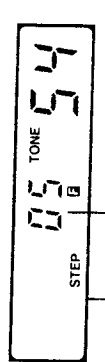

STEP 5

⑤ Press RHYTHM SELECTOR [10] and then press the INTRO/FILL-IN key to select [1] BAR.

Finally, press the START/STOP key to input STEP 5.

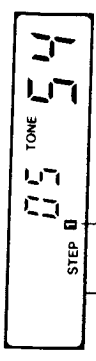

[1] BAR

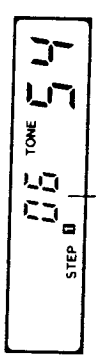

STEP 6

ENDING SONG INPUT

Once recording is started in the SONG MEMORY mode, it is stopped using the RHYTHM MODE selector to cancel the SONG MEMORY mode.

• Moving the RHYTHM MODE selector to SONG PLAY allows playback of a programmed song.

NOTE

• A maximum of 199 steps (measures) can be programmed into one song. Exceeding this results in the indicator "FL" (full) appearing on the display and further input will be impossible.
*The step count display does not advance to 200 when STEP 199 is input.

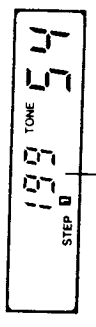

STEP 199 displayed even if more input attempted.

* Attempting to input the 200th step by pressing the START/STOP key results in the indicator "FL" (full) appearing on the display. The step count shows 199 when the START/STOP key is released.

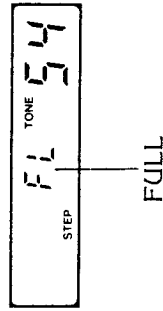

* The "FL" (full) display also appears when an attempt is made to insert a step into a song that already contains the maximum allowable 199 steps.

* The timbre number is displayed during song input as follows:

* The timbre available for 4-note polyphonic play is displayed when notes are not present in the PD line. The timbre displayed can be used for monophonic play when notes are present in 1 or more lines (1 through 3 only). The ten-key pad can be used to change the timbre number during playback.

* The display shows "--" for patterns in which notes are present in PD-4.

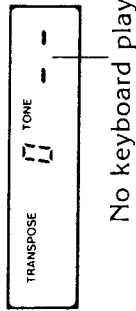

* Selecting a pattern in which notes are present in the PD sound source line during song step input causes the PD sound source indicator to light.

SONG EDITING

< LOCATING STEPS >

Specific portions of stored data can be corrected and modified either during song step input or anytime after input is complete. Enter the RECORD mode and use the VALUE VA keys to locate the step to be edited.

- The VALUE VA keys can also be used to locate steps while in the RECORD mode. If the SONG MEMORY mode has already been exited, set the RHYTHM MODE selector to SONG MEMORY and press the START/STOP (RECORD) key.
- Each press of V moves to the previous step, while A moves to the next step. Holding down either key causes high speed continuous change of the step.

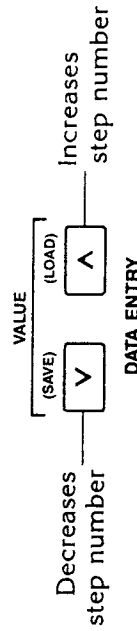

• Operation of the VALUE VA keys allows recall of the pattern stored in any step. The currently selected step (measure) number is shown on the display.

• The range of movement within a completed song is from the first step up to the step following the last step input. If the step following the last step input is recalled, playback is performed for the selected measure of the program number specified on the keyboard console.

< DELETE >
Once a step () in the RECOR to delete the

- When a step shifted forward for the step
- Deleting the for the rang of movermer put). At this of the progr

< INSERT >
Once a step () in the RECOR to insert a ne

① Press the S signal INSE at this time dicator to

<DELETE>

Once a step (measure) is located using the VALUE VA keys in the RECORD mode, the SYNCHRO (CLEAR) key can be used to delete the step.

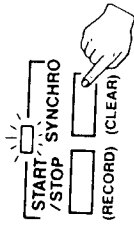

- When a step is deleted, all steps following are automatically shifted forward to fill the now empty step, and the new data for the step is played back.
- Deleting the last step of a song makes that step the new limit for the range of movement within a completed song (range of movement = first step up to step following last step input). At this time, playback begins for the selected measure of the program number specified on the keyboard console.

<INSERT>

Once a step (measure) is located using the VALUE VA keys in the RECORD mode, the SOLO (INSERT) key can be used to insert a new pattern at the selected step.

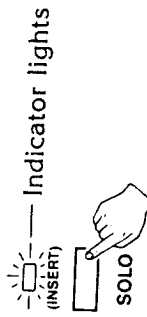

- ① Press the SOLO (INSERT) key and the indicator will light to signal INSERT STAND BY. Pressing the SOLO (INSERT) key at this time cancels INSERT STAND BY and causes the indicator to go OFF.

- ② After selecting the desired pattern program number and measure while in INSERT STAND BY, press the START/STOP (RECORD) key to input the selected pattern at the present step (measure).

- All steps (measures) following the location of the insert are shifted to allow for the new measure.

<Example>

Insert a new pattern between STEP 14 and STEP 15 of a song.

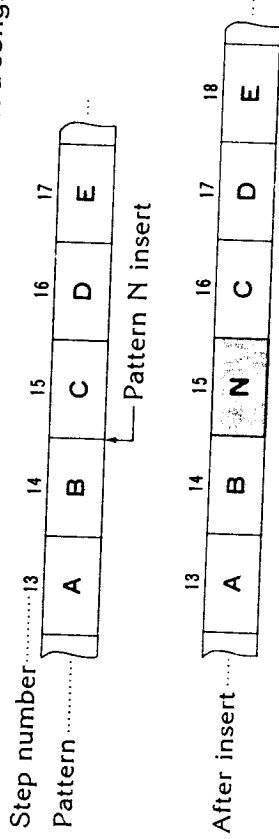

- Pressing the VALUE VA keys cancel INSERT STAND BY.

<STEP DATA MODIFICATION>

Once a step (measure) is located using the VALUE VA keys in the RECORD mode, the pattern recorded can be replaced with a different pattern.

- The measure selected using the VALUE VA keys is played back when selected. At this time, setting a new pattern program number and measure number plays back the new pattern. Now pressing the START/STOP key replaces the originally recorded pattern with the newly selected pattern.
- Only the selected step is modified with no effect upon any of the other steps in the song.

< **Example** >

Replace the pattern at STEP 15 (No.5/ [2] BAR) with a new pattern (No.8/ [F] BAR).

- 1 Enter the RECORD mode and use the VALUE VA keys to move to STEP 15.
 - At this time Program No.5/[2] BAR should begin to playback.
- 2 Press the PROGRAM key and RHYTHM SELECTOR [8], and use the INTRO/FILL-IN key to select the [F] BAR pattern.
 - At this time Program No.8/[F] BAR should begin to playback.

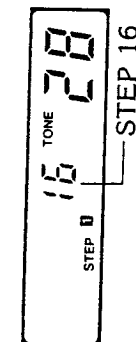
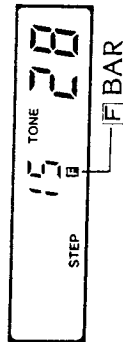
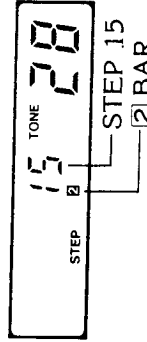

- 3 Press the START/STOP (RECORD) key to write the new data (No.8/ [F] BAR) at STEP 15. The unit will automatically advance to the next step (16) which will be indicated on the display.

NOTE

The following points should be noted carefully when performing the procedure outlined above:
Pressing the START/STOP (RECORD) key without first selecting a new input pattern causes the pattern for the currently selected rhythm selector to be input. The new input will not be played back because the unit immediately advances to the next step.

< **SUMMARY** >

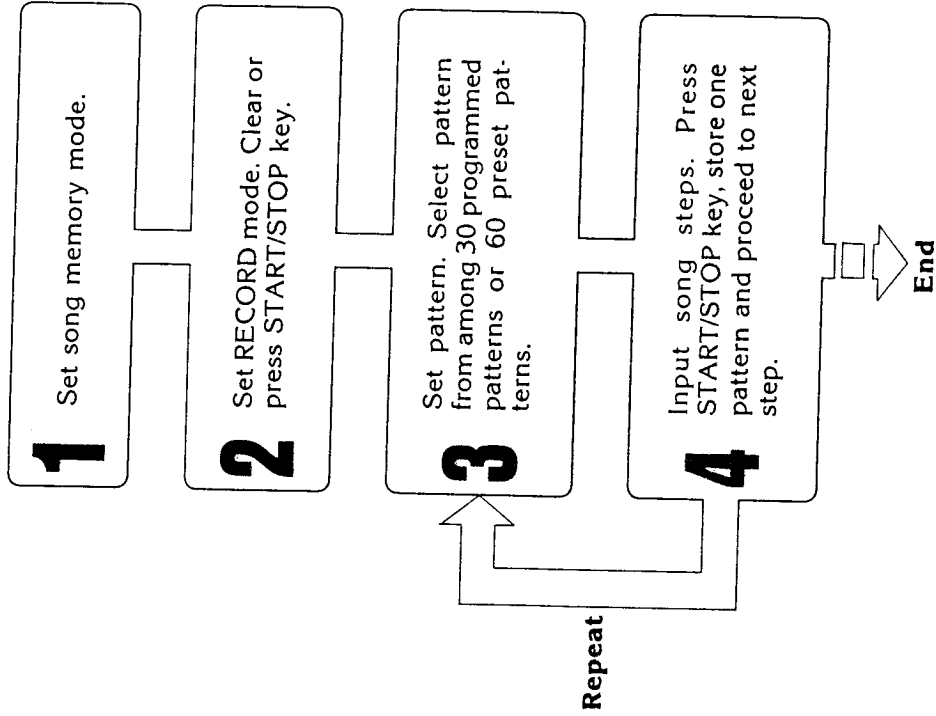

(5) SONG

SONG

- 1 Set the RHYTHM

- The PRESET function upon this

SONG

- 2 Pressing the [F] key from STEP

- The display shows the number during playback.

* Editing procedures (delete/insert/modify) not included here.

(5) SONG PLAY

SONG PLAY MODE SETTING

① Set the RHYTHM MODE selector to SONG PLAY.

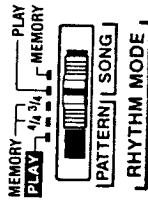

• The PRESET 1, 2, PROGRAM key selections have no effect upon this operation.

SONG PLAYBACK

② Pressing the START/STOP keys begins playback of the song from STEP 1.

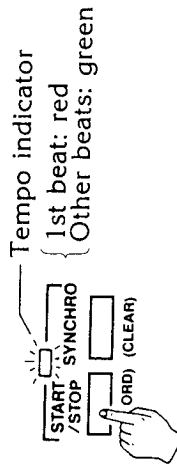

• The display shows the STEP number and pattern measure number during playback. The program number is not displayed.



③ The START/STOP key can be used to stop playback at any point. Playback is automatically terminated after the last step of the song is played.

SYNCHRO START AND CONTINUE PLAY

< SYNCHRO START >

Pressing the SYNCHRO START key while rhythm is not playing causes the tempo indicator to flash green to indicate SYNCHRO START STAND BY. In this mode, song playback will begin as soon as a key on the LOWER KEYBOARD is pressed.

• Pressing the SYNCHRO START key during SYNCHRO START STAND BY cancels the stand by mode.

SYNCHRO START STAND BY

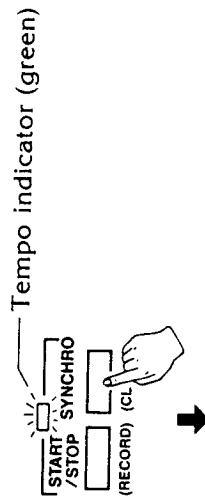

SYNCHRO START

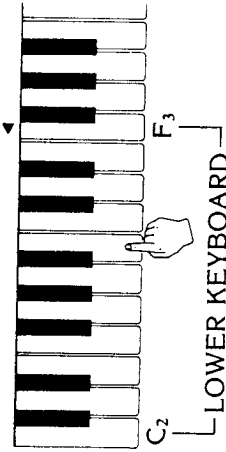

<CONTINUE PLAY >

Pressing the SYNCHRO key or INTRO/FILL-IN key during song playback suspends playback at that point. Pressing the START/STOP key again resumes playback from the point at which it was suspended.

- When playback is suspended using the SYNCHRO key, playback can also be resumed by pressing a key on the LOWER KEYBOARD.
- The TEMPO INDICATOR flashes green when playback is suspended by the SYNCHRO key and red when suspended using the INTRO/FILL-IN key.
- Pressing the SYNCHRO key again after playback is suspended by the SYNCHRO key, or pressing the INTRO/FILL-IN key again after playback is suspended by the INTRO/FILL-IN key terminates playback completely. CONTINUE PLAY can no longer be used in these cases.

NOTE

- The display appears as illustrated below during song playback operations.
- The timbre available for 4-note polyphonic play is displayed when notes are not present in the PD line. The timbre displayed can be used for monophonic play when notes are present in 1 or more lines (1 through 3 only). The ten-key pad can be used to change the timbre number during playback.

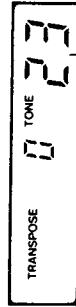

Number of timbre assigned to keyboard

*The display shows "--" for patterns in which notes are present in PD-4.

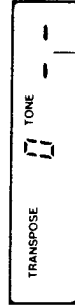

No keyboard play

- The display will show the final step number when a song is allowed to play to the end until it stops automatically. STEP 1 is always displayed whenever the START/STOP key is used to interrupt playback.
- The rhythm selectors are inoperative in the SONG PLAY mode.

The pitch of the PITCH BEND is the front of the direction

Rai:

Lower

• BEND

The pitch of the BEND is within a bend range of 0 through 127 when the BEND is adjusted up or down.

PITCH BEND

The pitch of the entire keyboard can be controlled by rotating the PITCH BEND wheel. Rotating the wheel in the direction of the front of the keyboard decreases pitch, while rotating it in the direction towards the back of the keyboard increases pitch.

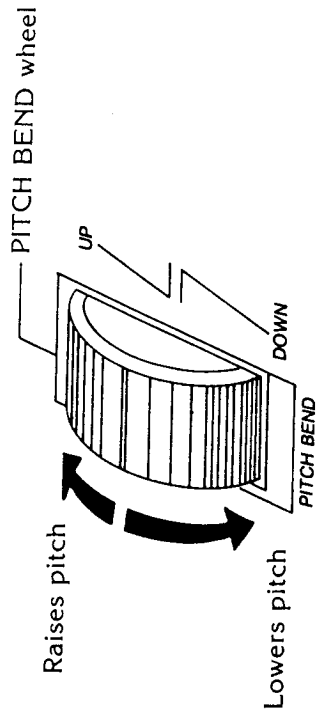

BEND RANGE

The pitch of the keyboard is changed by the PITCH BEND wheel within a bend range presettable with a numeric value in the range of 0 through 12. The display appears as illustrated below when the BEND RANGE key is pressed, and the bend range is adjusted using the VALUE ∇ \blacktriangle keys.

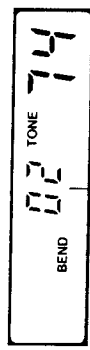

Bend range value (00 ~ 12)

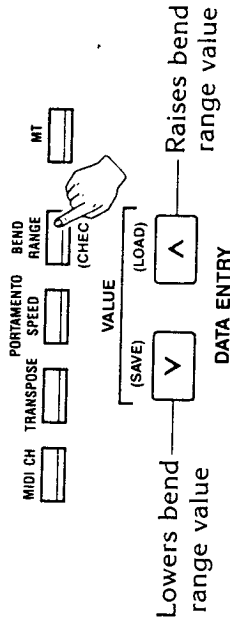

- Operation of the PITCH BEND wheel has no effect when the bend range is set to 00.
- Changing the bend range value by 1 results in a change in the bend range of ± 1 halftone.
- The maximum bend range is 12, and this represents an overall change in pitch of ± 1 octave.
- The bend range value is retained even when the power of the unit is switched OFF.

■ PORTAMENTO

The portamento effect causes note changes to be performed with the pitch sliding from one note to the next.

(1) PORTAMENTO ON/OFF

The PORTAMENTO key switches the portamento effect ON and OFF. Portamento is in effect when the indicator above the PORTAMENTO key is ON.

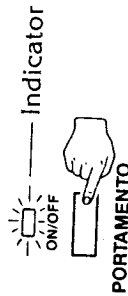

- The manner in which the portamento effect is applied depends upon whether the SOLO key is ON or OFF. When the SOLO key is ON, the portamento effect is only applied to legato play (next keys are pressed while current keys are still held down). When the SOLO key is OFF, all note changes, including non-legato, are played applying the portamento effect.

(2) PORTAMENTO SPEED

The speed at which the portamento effect slides up or down to the next note can be controlled (portamento speed). The display appears as indicated below when the PORTAMENTO SPEED key is pressed, and the portamento speed can be adjusted using the VALUE VA keys.

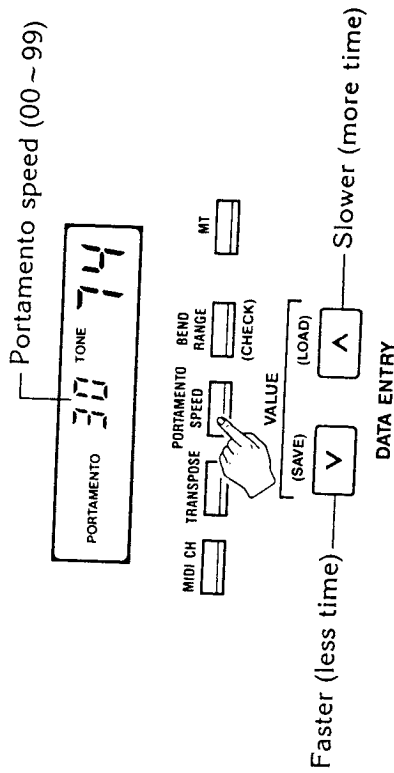

- Each press of V increases portamento speed, while ^ decreases portamento speed. Holding down either key causes high speed continuous change of the portamento speed.
- No portamento effect is applied when the portamento speed is set to 00.
- The portamento is set at its maximum when the portamento speed is set to 99 (approximately 17 seconds).
- The portamento speed value is retained even when the power of the unit is switched OFF.

■ TRA

The key of tr from the sta G~ F#. Th TRANSPOSI be adjusted (G)~6 (F#).

Decreases (halftone)

Transpose val
Key

- The transpos unit is switch

■ TRANSPOSE

The key of the entire keyboard can be adjusted at halftone steps from the standard key of C to any other key in the range of G ~ F#. The display appears as illustrated below when the TRANSPOSE key is pressed, and the key of the keyboard can be adjusted to any one of 12 values within the range of -5 (G) ~ 6 (F#).

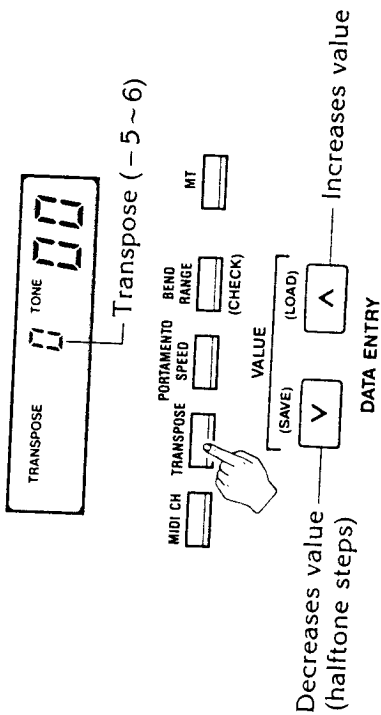

Transpose value	-5	-4	-3	-2	-1	0	1	2	3	4	5	6
Key	G	A ^b	A	B ^b	B	C	C [#]	D	E ^b	E	F	F [#]

•The transpose value is retained even when the power of the unit is switched OFF.

■ SOLO FUNCTION

The keyboard can be changed to monophonic by pressing the SOLO key.

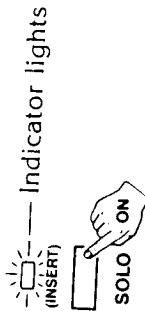

- Each press of the SOLO key switches the indicator above the key ON and OFF. When ON, the keyboard becomes monophonic with the most recently pressed keys given priority.
- The keyboard is polyphonic (8-note maximum) when the SOLO function is OFF.
- The number of notes that can be produced by the keyboard is limited during pattern and song playback, regardless of whether or not the SOLO function is ON. Only monophonic play is available when notes are present in one or more PD lines (PD1 ~ PD3). The keyboard produces no sound at all during playback of a pattern in which notes are present in the PD-4 line.

■ MT FUNCTION

The MT function makes it possible to use a cassette tape to store pattern and song data created through rhythm programming.

① SAVE

Transmission of pattern or song data to a cassette tape.

② VERIFY

Confirmation of whether data was stored correctly.

③ LOAD

Recall of data from cassette tape to the keyboard.

< CONNECTIONS >

Prepare a data recorder or ordinary cassette tape recorder and one blank tape. Using the accessory MT connecting cord, connect the tape recorder to the keyboard as illustrated below.

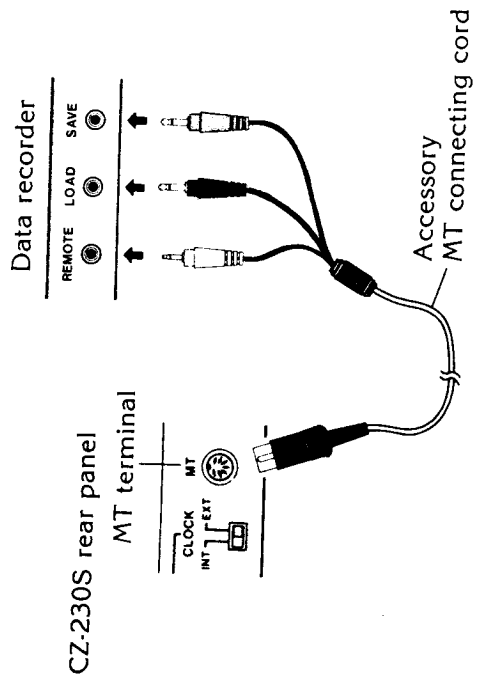

• The connecting cord is split among three plugs for the recorder. Each plug is color coded as follows:

REMOTE (white): Recorder remote (REM) terminal
*Not used when recorder has no remote (REM) terminal.

LOAD (black): Recorder earphone (EAR) terminal or load (LOAD) terminal

SAVE (red): Recorder microphone (MIC) terminal or save (SAVE) terminal

(1) SAVE

① Press the MT key and **MT** will appear on the display as illustrated below.

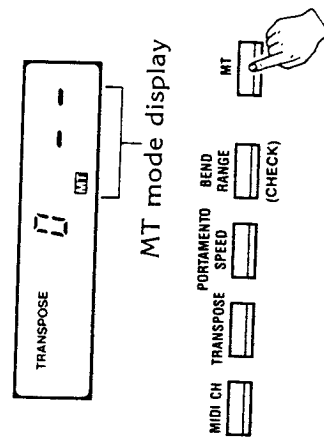

• No other modes or keys are operational while in the MT mode.

② Load a cassette tape into the recorder.

• The tape will be loaded with the remote terminal.

③ Press the MT key on the keyboard.

• The tape will be loaded with the remote terminal.

• The display will show the MT mode.

④ The display will show the MT mode.

• The tape will be loaded with the remote terminal.

• Cancel the MT mode.

⑤ Press the

(2) VERIFY

This operation confirms whether or not the data stored on a cassette is identical to that present in the keyboard memory. The verify operation should always be performed to confirm proper storage following the SAVE operation.

- ① Press the MT key. This operation can be skipped if the verify operation is performed immediately following data save.
- ② Rewind the cassette to a point immediately preceding the beginning of the data to be verified.
 - If the recorder being used is equipped with a remote terminal, put the recorder into its PLAYBACK (LOAD) mode.
- ③ Press the BEND RANGE (CHECK) key, and the display will appear as illustrated below.
- The tape will automatically begin to move with this operation on recorders equipped with remote terminals.

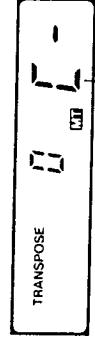

"C" displayed during verify operations

- For recorders without remote terminals, put the recorder in its PLAYBACK mode to begin verify operations.

- ④ The display will return to the original MT mode display when verify operations are complete.
 - The tape will automatically stop on recorders equipped with remote terminals.
 - Cancel the PLAYBACK (LOAD) mode of the recorder.

- ② Load a cassette tape into the recorder being used and put the recorder into its RECORD mode.
- The tape will not yet begin to move on recorders equipped with remote terminals.

- ③ Press the VALUE V (SAVE) key to begin data save to the cassette.
 - The tape will automatically begin to move with this operation on recorders equipped with remote terminals.
 - The display will appear as illustrated below during save operations.

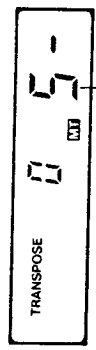
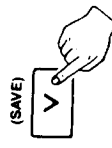

"S" displayed during save operations

- ④ The display will return to the original MT mode display when save operations are complete.
- The tape will automatically stop on recorders equipped with remote terminals.
- Cancel the RECORD mode of the recorder.
- ⑤ Press the MT key to exit the MT mode.

The following VERIFY operation should be performed whenever data is saved to a cassette tape.

- ⑤ Press the MT key to exit the MT mode.

VERIFY ERRORS

The display will appear as illustrated below whenever an error is detected during the verify operation.

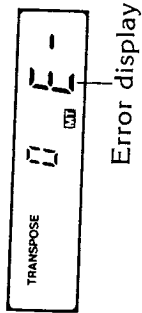

- Whenever an error display appears, press the MT key to terminate verify operations and save the data from the keyboard to the cassette tape again.
- Frequent verify errors may indicate incorrect recorder settings or a faulty recorder. An insufficient playback level during verify or a low record level during save operations are possible causes of poor recordings. If problems still exist after correct adjustments are made, try using a different recorder.

(3) LOAD

- ① Press the MT key and [MT] will appear on the display as illustrated below.

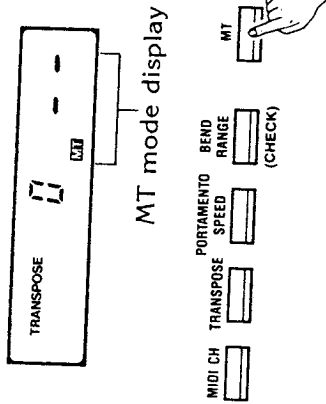

- ② Rewind the cassette to a point immediately preceding the beginning of the data to be loaded.
 - If the recorder being used is equipped with a remote terminal, put the recorder into its PLAYBACK (LOAD) mode.

- ③ Press the VALUE ^ (LOAD) key, and the display will appear as illustrated below.

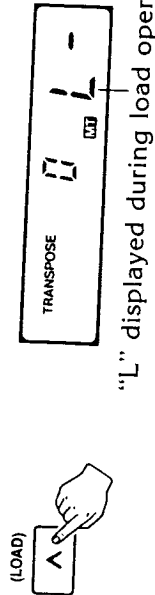

- The tape will automatically begin to move with this operation on recorders equipped with remote terminals.
- For recorders without remote terminals, put the recorder in its PLAYBACK mode to begin load operations.

- ④ The display load operation
- The tape remote terminal
- Cancel terminal
- ⑤ Press the

The display an error

- When the terminal the cassette
- Frequency setting; cause error correct

- The display will return to the original MT mode display when load operations are complete.
- The tape will automatically stop on recorders equipped with remote terminals.
- Cancel the PLAYBACK (LOAD) mode of the recorder.

⑤ Press the MT key to exit the MT mode.

LOAD ERRORS

The display will appear as illustrated below whenever an error is detected during the load operation.

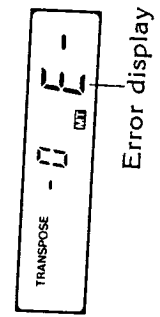

- Whenever an error display appears, press the MT key to terminate load operations and load the data from the cassette to the keyboard.
- Frequent load errors may indicate incorrect recorder settings or a faulty recorder. A low playback level can cause errors to be generated. If problems still exist after correct adjustments are made, try using a different recorder.

display as il-
 eeding the
 note termi-
) mode.
 will appear
 operations
 this opera-
 als.
 recorder in

(4) POLY MODE/MONO MODE

The CZ-230S is equipped with both a MONO mode and a POLY mode.

• POLY mode

Communications of a single timbre (like 4-note polyphonic synthesizer)

• MONO mode

Monophonic communications of separate timbres on 4 channels

① POLY MODE SETTING

Switch the power of the keyboard ON, and press the MIDI CH key. The display should now appear as illustrated below.



The VALUE VA keys can now be used to set the channels (01 ≡ MIDI CH ≡ 16), and the ten-key pads are used to set the timbres.

② MONO MODE SETTING

Switch the power of the keyboard ON while holding down the SOLO key to set the MONO mode. Press the MIDI CH key and the display should appear as illustrated below.



Set the timbre for MIDI CH 1 using the ten-key pad. Then press the VALUE A key to advance to MIDI CH 2 and set the timbre. This procedure is repeated until timbres are set for each MIDI channel from 1 through 4.

(3) BASIC CHANNELS

Set the timbres for the sample data listed below.

< Example >

CHANNEL	TIMBRE NUMBER (NAME)
CH 01	03 (SYMPHONIC ENS. 1)
CH 02	31 (FLUTE)
CH 03	33 (VIOLIN)
CH 04	51 (PIANO 2)

The VALUE VA keys can now be used to raise and lower the channel to play the timbres assigned to the channels.

At this time, the first channel (CH 01) is called the basic channel. The basic channel can be changed by returning to the POLY mode, changing the channels, and then switching power ON while holding the SOLO key. When the basic channel is set to 05, for example, the timbres in the MONO mode are assigned to channels 05, 06, 07, 08. Setting a basic channel of 10 assigns timbres to channels 10, 11, 12, 13.

(4) INDIVIDUAL CHANNEL VOLUME SETTINGS

The volume for each channel can be individually adjusted to one of nine levels (L0 ~ L9). Setting volume to L0 results in no output.

The volumes for the sample timbres input for the previous example will be set as noted in the table.

CHANNEL	LEVEL
CH 01	5
CH 02	8
CH 03	9
CH 04	7

Starting with CH 01, press and hold down the MIDI CH key and use the VALUE \blacktriangledown keys to set the volume to L6.

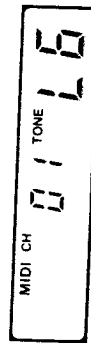

Release the MIDI CH key and press VALUE \blacktriangle to advance to CH 02. Set the value using the same procedure as outlined above. Proceed on to CH 03 and CH 04.

(5) PORTAMENTO ON/OFF

The PORTAMENTO ON/OFF status can be individually set in the MONO mode for each channel.

Enter the MONO mode, select the desired channel using the VALUE key, and then set portamento to ON or OFF.

CH 01	ON
CH 02	OFF
CH 03	OFF
CH 04	ON

- The LED above the SOLO key is normally lit in the MONO mode.
- The MONO mode can only be exited by switching the power of the keyboard OFF.
- Pattern memory and song memory operations cannot be performed in the MONO mode.
- In the MONO mode, notes written using the PD sound source cannot be sounded. Only PCM rhythms can be sounded.

(6) MID

The control the back pa

- The MIDI C MIDI mess

ON: All MIC
OFF: No MII

- The CLOCK which is sta
START real-
MIDI instr

INT: CZ-230
EXT: Other t

(6) MIDI ON/OFF, CLOCK INT/EXT

The controls for the procedures outlined below are located on the back panel of the unit.

- The MIDI ON/OFF switch is used to select whether or not all MIDI messages are communicated.

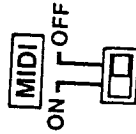

- ON:** All MIDI messages available with CZ-230S communicated.
- OFF:** No MIDI messages communicated.

- The CLOCK INT/EXT switch selects which unit is master and which is slave for MIDI CLOCK, START, STOP, CONTINUE/START real-time messages for MIDI communication between MIDI instruments.

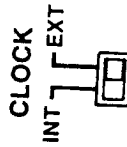

- INT:** CZ-230S master, other unit slave (INT = INTERNAL)
- EXT:** Other unit master, CZ-230S slave (EXT = EXTERNAL)

For pattern memory (4/4 or 3/4) and song memory in the rhythm mode, MIDI is OFF and CLOCK is INT regardless of the position of the switches.

(7) SAMPLE CONFIGURATIONS

- ① Connection with SZ-1 for automatic play of 4 voices + drums.

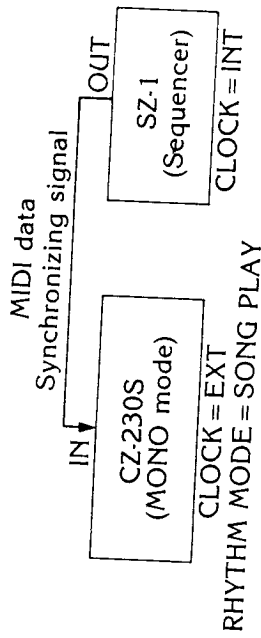

- ② Connection with CZ-5000 (with built-in sequencer) for use as external sound generator and drum machine.

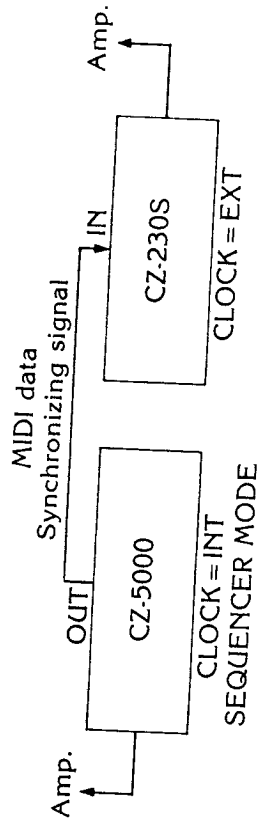

■ CARE OF YOUR UNIT

1. Avoid heat, humidity, and direct sunlight.

Do not overexpose the unit to direct sunlight, place it near a heater, or in any area subject to high temperature.

2. Severe impacts can result in malfunction.

When carrying or transporting the unit, protect the keyboard and buttons by packing with soft cloth.

3. Keep the unit free of liquids, dust, particles, etc.

Do not allow foreign matter to enter between the keys. Be especially careful of metallic objects such as hairpins, sewing needles or coins. Also, do not allow the unit to get wet.

4. Never attempt to modify any part of the unit.

Your keyboard is a precision musical instrument made up of sophisticated electronic parts. Any modification of, or tampering with internal components can cause trouble or malfunction.

5. Do not use lacquer thinner or similar chemicals for cleaning.

Clean the keyboard with a soft cloth dampened with a mild detergent solution. Soak the cloth in the detergent solution and squeeze it until almost dry.

- ### 6. Remove batteries before extended storage.
- Batteries left in the unit for long periods can leak and cause damage to electronic circuitry.

■ SP

Model:
Keyboard
Sound
generator
Polyphony
Preset voi
Effects:

Preset rhy
Rhythm
programm

Rhythm
operation:

Tuning:
Other:
MT:

SPECIFICATIONS

Model:	CZ-230S digital programmed synthesizer	MIDI:	Poly mode (MODE 3)/Mono mode (MODE 4)
Keyboard:	49 keys, 4 octaves (mini type)		Basic channel: 01 ~ 16
Sound generator:	PD sound source (phase distortion)		Number of voice channels: 4 (MONO mode)
Polyphony:	8 notes (1 DCO) or 4 notes (2 DCO)		MIDI ON/OFF
Preset voices:	100 (including 4 internal)		CLOCK INT/EXT
Effects:	PORTAMENTO ON/OFF, PORTAMENTO SPEED, PITCH BEND, BEND RANGE	Audio terminals:	LINE OUT(PD/PCM), PHONES
Preset rhythms:	20 rhythms/80 patterns (including intro/fill-in)	Control terminals:	MT, MIDI (IN/OUT/THRU)
Rhythm programming:	<ul style="list-style-type: none">• Pattern memory: 30 patterns max. (PCM x 12, PD x 4)• Pattern play• Song memory: 199 steps (measures) max.• Song play	Power supply:	<ul style="list-style-type: none">• Batteries: Six D size dry cells (operation/memory back up)* Battery life: 3.5 hours (main power supply), 1 year (when AC adaptor used)• AC: 100, 117, 220, 240V (optional AD-5 adaptor)• Car battery: Optional CA-5 car adaptor
Rhythm operation:	START/STOP, SYNCHRO START, INTRO/FILL-IN, TEMPO (J = 40 ~ 256)	Speaker:	Auto power off (approximately 6 minutes), forced power off 12cm dia. x 1
Tuning:	A4 = 442Hz ± 100 cents (± 1/2 tone)	Power consumption:	9.1W
Other:	TRANSPPOSE (G ~ F #), SOLO ON/OFF	Dimensions:	806(W) x 206(D) x 76(H)mm
MT:	Pattern/song data SAVE/VERIFY/LOAD	Weight:	3.9kg (including batteries)
		Accessories:	Six D size dry cells, MT connecting cord

*All designs and specifications subject to change without notice.