

MX9000

EURODESK®

User's Manual

Version 1.1 July 2002

ENGLISH



www.behringer.com

SAFETY INSTRUCTIONS

CAUTION: To reduce the risk of electrical shock, do not remove the cover (or back). No user serviceable parts inside; refer servicing to qualified personnel.



WARNING: To reduce the risk of fire or electrical shock, do not expose this appliance to rain or moisture.



This symbol, wherever it appears, alerts you to the presence of uninsulated dangerous voltage inside the enclosure - voltage that may be sufficient to constitute a risk of shock.



This symbol, wherever it appears, alerts you to important operating and maintenance instructions in the accompanying literature. Read the manual.

DETAILED SAFETY INSTRUCTIONS:

All the safety and operation instructions should be read before the appliance is operated.

Retain Instructions:

The safety and operating instructions should be retained for future reference.

Heed Warnings:

All warnings on the appliance and in the operating instructions should be adhered to.

Follow instructions:

All operation and user instructions should be followed.

Water and Moisture:

The appliance should not be used near water (e.g. near a bathtub, washbowl, kitchen sink, laundry tub, in a wet basement, or near a swimming pool etc.).

Ventilation:

The appliance should be situated so that its location or position does not interfere with its proper ventilation. For example, the appliance should not be situated on a bed, sofa rug, or similar surface that may block the ventilation openings: or placed in a built-in installation, such as a bookcase or cabinet that may impede the flow of air through the ventilation openings.

Heat:

The appliance should be situated away from heat sources such as radiators, heat registers, stoves, or other appliance (including amplifiers) that produce heat.

Power Source:

The appliance should be connected to a power supply only of the type described in the operating instructions or as marked on the appliance.

Grounding or Polarization:

Precautions should be taken so that the grounding or polarization means of an appliance is not defeated.

Power-Cord Protection:

Power supply cords should be routed so that they are not likely to be walked on or pinched by items placed upon or against them, paying particular attention to cords and plugs, convenience receptacles and the point where they exit from the appliance.

Cleaning:

The appliance should be cleaned only as recommended by the manufacturer.

Non-use Periods:

The power cord of the appliance should be unplugged from the outlet when left unused for a long period of time.

Object and Liquid Entry:

Care should be taken so that objects do not fall and liquids are not spilled into the enclosure through openings.

Damage Requiring Service:

The appliance should be serviced by qualified service personnel when:

- The power supply cord or the plug has been damaged; or
- Objects have fallen, or liquid has been spilled into the appliance; or
- The appliance has been exposed to rain; or
- The appliance does not appear to operate normally or exhibits a marked change in performance; or
- The appliance has been dropped, or the enclosure damaged.

Servicing:

The user should not attempt to service the appliance beyond that is described in the Operating Instructions. All other servicing should be referred to qualified service personnel.

FOREWORD

Dear Customer,

Welcome to the team of EURODESK users and thank you very much for expressing your confidence in BEHRINGER products by purchasing the MX9000.

It is one of my most pleasant tasks to write this letter to you, because it is the culmination of many months of hard work delivered by our engineering team to reach a very ambitious goal: making an outstanding device that will become a standard tool used by studios and P.A. companies. The task to design the EURODESK certainly meant a great deal of responsibility, which we assumed by focusing on you, the discerning user and musician. It also meant a lot of work and night shifts to accomplish this goal. But it was fun, too. Developing a product usually brings a lot of people together, and what a great feeling it is when everybody who participated in such a project can be proud of what we've achieved.

It is our philosophy to share our joy with you, because you are the most important member of the BEHRINGER family. With your highly competent suggestions for new products you've greatly contributed to shaping our company and making it successful. In return, we guarantee you uncompromising quality (manufactured under ISO9000 certified management system) as well as excellent technical and audio properties at an extremely favorable price. All of this will enable you to fully unfold your creativity without being hampered by budget constraints.

We are often asked how we can make it to produce such high-grade devices at such unbelievably low prices. The answer is quite simple: it's you, our customers! Many satisfied customers means large sales volumes enabling us to get better conditions of purchase for components, etc. Isn't it only fair to pass this benefit back to you? Because we know that your success is our success, too!

I would like to thank all people whose help on "Project EURODESK MX9000" has made it all possible. Everybody has made very personal contributions, starting from the designers of the unit via the many staff members in our company to you, the user of BEHRINGER products.

My friends, it's been worth the trouble!

Thank you very much,

A handwritten signature in black ink, appearing to read 'U. Behringer', with a long horizontal flourish extending to the right.

Uli Behringer

TABLE OF CONTENT

1. THE MANUAL	6
1.1 Nomenclature	6
1.2 An un-holistic approach	6
1.3 Key	6
2. EURODESK OVERVIEW	6
2.1 Architecture	6
2.2 Metering	7
2.3 PSU (Power Supply Unit)	7
3. INPUT/OUTPUT CHANNEL	8
3.1 Channel strip	8
3.2 Input switching	8
3.3 Input gain setting	9
3.4 Main equalizer	10
3.5 Aux sends	10
3.6 Routing and muting	11
3.7 B-channel	12
4. INSERTS	13
5. SUBGROUP AND DIRECT OUTPUTS	14
5.1 Subgroups	14
5.2 Direct outputs	16
6. MASTER PANEL	16
6.1 Aux masters	16
6.1.1 Aux sends	16
6.1.2 Aux returns	17
6.2 MIX-B master	19
6.3 Monitoring	20
6.4 Headphones	21
6.5 PFL/SOLO	22
6.5.1 PFL	22
6.5.1 SOLO	22
6.6 Talkback	22
7. CONNECTIONS	23
7.1 Rear panel	23
7.2 Plug soldering guide	27
8. THE PATCHFIELD	30
8.1 The normalized bay	30
8.2 The patchfield	30
8.3 Looming problems	32
9. EQUALIZATION	33
10.GAIN OPTIMIZATION	34
11.IMPEDANCES AND TUNING	35
12.(UN)BALANCED LINES	35

13.START-UP	37
13.1 A-channel setting up procedure	37
13.1.1 Selecting inputs	37
13.1.2 Initializing channel for gain-setting	37
13.1.3 Auditioning a signal	37
13.2 Desk/tape setting up procedures	37
13.2.1 Desk normalization	37
13.2.2 Multitrack initialization	38
13.2.3 Recording levels	38
13.2.4 Auditioning a mix	38
13.2.5 Mixer mapping	38
14.8-TRACK MIDI SUITE/DANCE PRODUCTION STUDIO	38
14.1 Sends	39
14.2 Auxless headphones mix	39
14.3 Returns	40
14.4 Lining up record/sample inputs	41
14.5 Mixdown	41
15.16-TRACK RECORDING WITH 2 SAMPLERS	41
15.1 Recording	41
15.2 Headphones	42
15.3 Mixdown	42
16.PROFESSIONAL 24-TRACK STUDIO	42
16.1 Recording	42
16.2 Very tricky headphones	43
16.3 Wet monitoring	44
16.4 Mixdown	44
17.LIVE P.A. WITH 2-TRACK RECORDING	45
18.LIVE CONCERT WITH 24-TRACK RECORDING	46
19.EXPANDING THE EURODESK MX9000	48
19.1 Connections	48
19.2 Alignment	48
20.TIMECODE	48
21.BOUNCING	49
22.SEQUENCING “LIVE”	49
23.INPUT/OUTPUT CONFIGURATION	50
24.MODIFICATIONS	50
24.1 Aux sends > post EQ	51
24.2 MIX-B source > post fader	51
24.3 LED meters > pre fader	51
25.SPECIFICATIONS	52
26.WARRANTY	54

1. THE MANUAL

1.1 Nomenclature

Most specialist subjects are not really all that difficult provided you understand the language used, and the vocabulary of mixing is pretty straightforward. Nevertheless, it is as well to be clear about what certain terms mean. A “slot” in a recorder will always be referred to as a TRACK, while that in a mixer will invariably be a CHANNEL. A GROUP will always refer to a submix of channels, never a collection of musicians. Similarly the term BAND will be mentioned only in conjunction with FREQUENCY. We will attempt to be as unambiguous as possible with terms, since much confusion can arise from sloppy definitions.

Some terms can have a plurality of meanings. TRACK, in mixing parlance, refers to a tape recorder. In electronic circuits, components on a PCB (printed circuit board) are linked by flat conductors called TRACKS. Hopefully, where terms have different meanings the contexts will be sufficiently diverse so as to avoid any possible confusion.

1.2 An un-holistic approach

It is virtually impossible to fully explain one aspect of a mixing console (e.g. CHANNEL ROUTING) without also making it clear what those routes are, where they go, are they migratory, etc. That’s why we have compartmentalized the EURODESK manual into sections, making it easy to find problem solving information and advice. You might find that several cross-sectional references have been made, where areas of interest overlap. E.g.: Channel EQ is specified and described in the “Main equalizer” section 3.4, while EQUALIZATION has it’s own section, reflecting it’s importance and weight as a subject in it’s own right.

If we keep repeating ourselves concerning the use of B-channels and the MIX-B bus, it’s because a proper understanding of this area of the board will greatly expand your mixing repertoire.

1.3 Key

All DESK functions will be numbered consistently throughout the manual, whether they be in the text or in an illustration. In addition the following prefixes will be used to denote the various types of function control in any illustrations/text respectively:

Prefix	Meaning
S	Switch
L	LED
P	Potentiometer
F	Fader

Tab. 1.1: Meaning of the used prefixes

After every prefix you will find the FUNCTION NUMBER. Numbering starts at the top of a CHANNEL, works its way through a stereo GROUP, and finally through the MASTER SECTION. The phantom power and tape operating level switches are not included in the numbering system.

2. EURODESK OVERVIEW

2.1 Architecture

The EURODESK MX9000 is a hybrid SPLIT/INLINE console. Input channels cover most of the surface from the left, while the outputs to tape are to the right. Tape monitor returns, however, are housed within the channel strips, not next to the tape outputs, as would be the case in a conventional “split” design. This architecture

enables much flexibility to be bestowed onto the tape monitor signal path, not least being its ability to pick up functions easily from the main channel. Also, during mixdown, when tape tracks are no longer monitored but MIXED, the signal path between tape input and main channel is kept to a minimum.

The configuration is 24 into 8 into 24. This means that there are 24 channels, eight subgroups or “submixes” (or four stereo subgroups) and 24 tape monitor returns, one for each channel. There are 24 100 mm channel faders, eight subgroup faders, and a stereo pair of faders driving the L/R main mix.

In remix mode 48 channels are available, all with EQ and access to the aux buses. There are six additional stereo FX returns, giving a grand total of 60 separate line-level inputs: and that’s before you even consider using the subgroup insert points to provide eight more!

There are six aux buses accessed by four potentiometers, two headphone mixes and professional recording, monitoring and talkback facilities. If you can afford to lose the extra 24 line inputs, the MIX-B bus can also act as a separate stereo aux send, giving eight aux buses in all.

A comprehensive set of inputs and outputs include MIC (+48 V), line, tape (+4 dBu or -10 dBV), inserts all round, direct channel outs and all master recorder and monitoring options. Just about everything you’d expect from a massive console.

In addition, a 1/4" jack expander bay (INPUT ONLY) allows direct patching into all buses within the EURODESK (except PFL and SOLO). Hence two EURODESKs may be linked, or the EURODESK coupled to ANY OTHER CONSOLE, large or small, provided that the other console has (or can be MADE to have) similar access (see section 19 “EXPANDING THE EURODESK”).

Last, and probably least, two BNC connectors on top of the built-in meterbridge await optional gooseneck desk lights, available from all good gooseneck desk light stores. A must for those darkened auditoria, or when you’re into your third consecutive night in the studio.

2.2 Metering

The 1 to 24 channels have signal (-20 dB, L25) and overload LEDs (PEAK, L24).

The built-in meterbridge provides 12 segment bargraph meters for all channels and subgroups as well as for the main mix. By the DISPLAY MODE switch (S100, top left of the master section) you decide between CHANNEL and TAPE MODE. Your choice will be indicated by a LED.

In CHANNEL MODE, which is the best for live mixing purposes, the LED meters read the channel’s direct OUTPUT, which is post EQ, post mute and post fader (you may alter that to pre mute and pre fader by the modification described in APPENDIX II.3).

In TAPE MODE the channel meters will mirror the multitrack’s meters, because they read the tape return inputs – after the OPERATING LEVEL switch, but unaffected by anything else happening in the channel. 0 dB is referenced to the selected tape operating level (+4 dBu or -10 dBV).

The main mix meters double up as mono PFL or stereo SOLO meters, or 2-track return meters, or EXTERNAL return meters (in general, what you HEAR is what you SEE). During PFL/SOLO only the main mix bargraph meters illuminate.

 **In SOLO/PFL mode a 0 dB meter reading matches an internal operating level of 0 dBu (0.775 V). However, when looking at the mix, 0 dB is referenced to +4 dBu, the 2-track operating level. I.e. if only ONE signal is present in the main mix bus, SOLOing that signal will cause the meter reading to increase by +4 dB.**

2.3 PSU (Power Supply Unit)

Not an infection of the urinary tract, in fact PSU stands for the least glamorous, most frequently underestimated feature of any electronic device: the POWER SUPPLY UNIT. The EURODESK remote PSU connects to the desk at the rear of the console via a multiway connector. 2 1/2 U high, nevertheless it is designed to slot into a 3U rack space. The extra 1/2 U is to allow air to circulate around the heatsinks employed for heat dissipation. If your control room is small, forget heating. The EURODESK PSU chucks out a massive 400 Watts.

Why? Any amplifier circuit is limited in its transient response by the available current. In common with most desks of this size, the EURODESK has more than a thousand line-level operational amplifiers (op-amps) inside. When being driven hard, many desks begin to show signs of stress due to power supply limitations. Not so with the EURODESK MX9000. The sound should stay clean and crisp and TIGHT right up to the operating limits of the op-amps themselves.

 **Do not connect the PSU to the EURODESK while the PSU is connected to the mains supply.**

3. INPUT/OUTPUT CHANNEL

3.1 Channel strip

On the EURODESK MX9000 the 24 INPUT + OUTPUT (I/O or “normal”) channels cover most of the console. Most of each strip is occupied by the main or A-CHANNEL, accepting MIC, LINE or TAPE inputs, depending on the positions of S1 and S3 (see fig. 3.1 and 3.2). Each channel strip also sports a secondary B-CHANNEL (fig. 3.6) Anything routed to a B-channel is directed to a separate MIX-B bus. (See section 3.7 “B-channel” and also section 6.2 “MIX-B master”).

3.2 Input switching

First, look at the MIC/LINE switch S1. In the UP position it selects MIC, in the DOWN position LINE. The next switch S3 chooses whether A-channel looks at INPUT or TAPE. If INPUT is routed to A-channel, TAPE is offered to B-channel. If TAPE is routed to A-channel, INPUT is offered to B-channel. Depressing the PAD switch (S1a) lowers an incoming mic signal by -20 dB, if necessary.

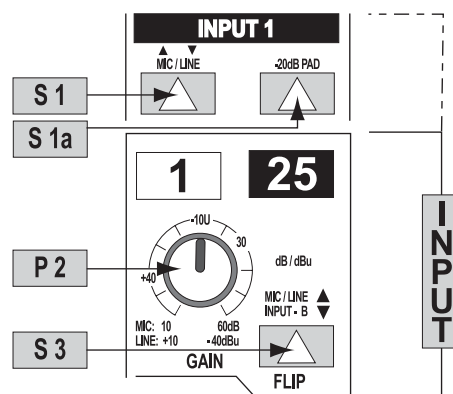

Fig. 3.1: Input

When laying tracks, it is usual to use the MIX-B inputs for monitoring the signal from TAPE, while the A-channels take care of microphones, DI's, etc. For MIXING purposes, TAPE tracks are normally “flipped” onto the main channels, leaving the B-channels free for other applications, such as offering extra line inputs. These rules are, however, made to be broken.

S23 applies to the B-channel only and replaces the normal TAPE or INPUT source with a tap from the main channel, taken post mute and pre fader. Now MIX-B acts as an extra stereo aux send or extra stereo mix. You should remove MIX-B from the main mix (via S48, master section) in this configuration.

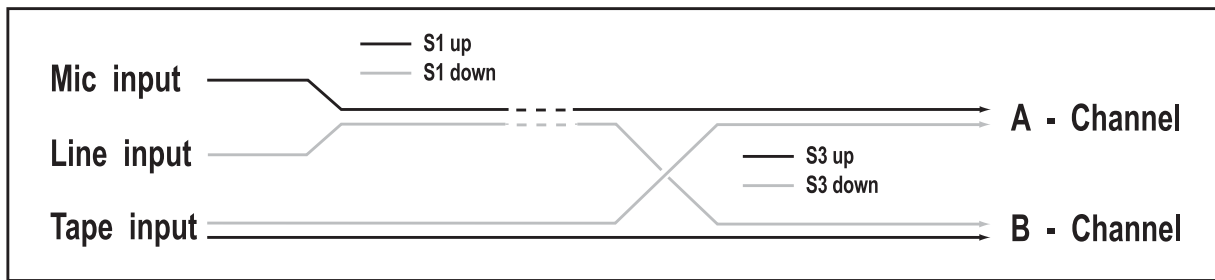

Fig. 3.2: Channel input switching architecture

👉 The B-channels 25 to 48 are only routable EN BLOC to the main mix, via S48. Therefore, the MIX-B bus can only have one function at any one time, either as a stereo AUX or secondary mix send (S48 UP) or as a set of 24 extra line or tape inputs to the main mix (S48 DOWN).

3.3 Input gain setting

The channel input level is set by the TRIMPOT (P2). Use SOLO/PFL (S26) to bring the channel's input onto the L/R bargraph meters under the master section of the EURODESK MX9000. This also sends the SOLO/PFLed signal to the left and right speakers. Channel PFL/SOLO (S26) has an associated LED (L26). (See also 13.1 "A-channel setting up procedure" and 6.5 "Solo/PFL".)

👉 For level-setting (as opposed to localized listening) choose to use the mono PFL rather than the post fader SOLO bus (S95 DOWN).

👉 SOLO/PFL never interrupts the mix at the main recording outputs. It follows that aux sends and subgroups must also be unaffected, since they can contribute directly to the main mix.

In addition to switchable PFL/SOLO metering, a couple of LEDs (L24 and L25) continuously monitor whether a signal is present (-20 dB) or the channel is going into overload (PEAK). These take their cue from three test points: input, post EQ and post fader. In all cases the higher level wins. You do NOT want the overload light to come on, or if it does no more than very intermittently during a take or a mix.

3.4 Main equalizer

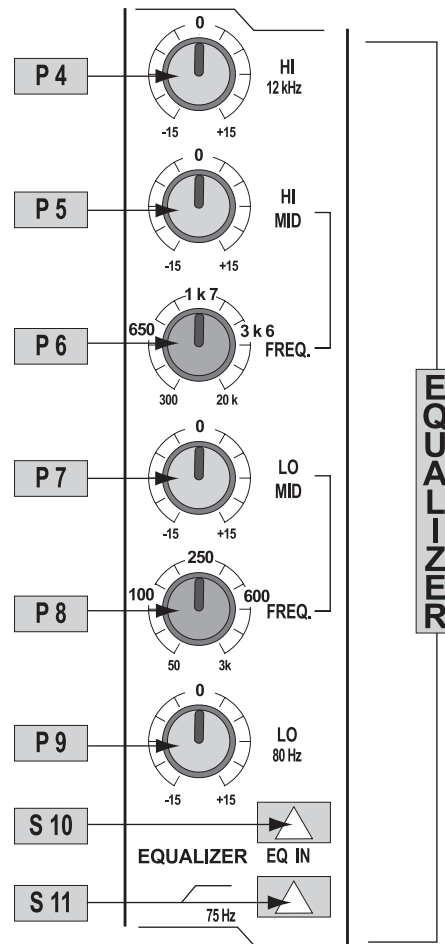

Fig. 3.3: Main equalizer

The main equalizer can be switched (S10) out of circuit for easy A/B comparisons between EQed and straight signals, or when you know that you don't want to use desk EQ at all. It is best considered in three sections. First, there are two Baxendall shelving frequency controls for treble and bass, at 12 kHz and 80 Hz respectively (P4 and P9). These are DUPLICATED for the B-channel (P18 and P19), not merely "SPLIT" off from the main EQ. I.e. you can have a full 4-band EQ on the main channel AND a 2-band EQ on B-channel.

Secondly, there are two semi-parametric swept mids, Q fixed at 1, which cover the bands 300 Hz to 20 kHz and 50 Hz to 3 kHz. An unusually broad frequency range is catered for, and there is an enormous 3-plus octave overlap between the two mid bands (P5, P6, P7 and P8). No experienced engineer will complain about that! All four bands offer 15 dB of cut and boost.

Thirdly, there is a steep high pass (low cut) filter (S11), slope @ 12 dB/octave, -3 dB @ 75 Hz, for reducing floor rumble, plosives, woolly bottom end, etc.

3.5 Aux sends

All six aux sends are mono and post EQ. They are switchable PRE/POST fader in two banks (S13 and S16). For aux sends 1 and 2, two dedicated pots (P12 and P13) are used. These can be taken from a point before or after the channel fader, i.e. PRE or POST (S13). Aux sends 3 and 4, and 5 and 6 are serviced by two potentiometers (P14 and P15). The SHIFT button (S15) determines whether buses 3 and 4 or 5 and 6 are addressed. Also, these four sends can be derived from the main mix or MIX-B, depending on SOURCE (S17), and, as before, can be pre or post (S16).

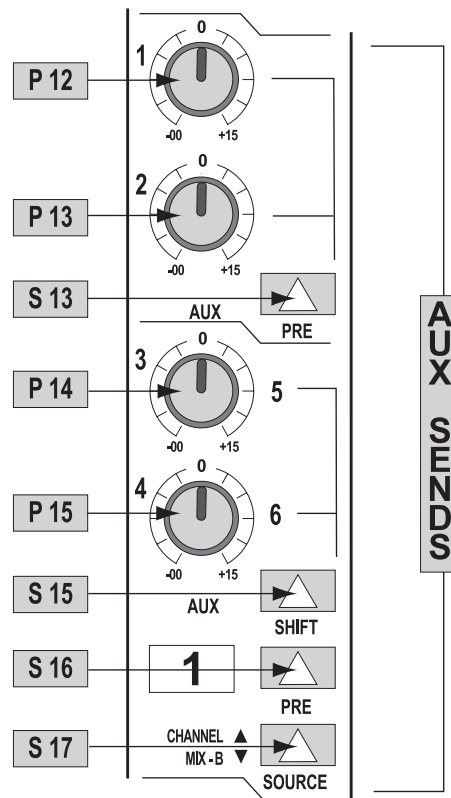

Fig. 3.4: Aux sends

- 👉 For almost all FX SEND purposes, you will want auxes to be post fader, so that when a fader level is adjusted, any reverb send from that channel follows the fader. Otherwise, when the fader is pulled down, the reverb from that channel would still be audible. For CUEing purposes, aux sends will usually be set pre fader, i.e. independent of the channel fader (S13 and S16).
- 👉 Most reverbs etc. sum up the left and right inputs internally. The very few that don't may be driven in true stereo either by 1) 2 aux sends or 2) the MIX-B bus (see section 3.7 "MIX-B").
- 👉 There is +15 dB of gain on every aux send. Such a high boost is only appropriate where the channel fader is set around -15 dB or lower. Here, an almost exclusively WET signal will be heard. Previously, in most consoles, such a wet mix required the use of a PRE setting for the channel auxiliary send. This meant losing fader control over the signal.

3.6 Routing and muting

ROUTING means selecting which BUS you want a channel to address. There are actually six stereo buses in the EURODESK MX9000 (plus a stereo SOLO bus). The main mix bus is selected by S32 (see figure 3.5), while the subgroups are selected by switches S28 (for groups 1 and 2), S29 (3 and 4), S30 (5 and 6) and S31 (7 and 8). Odd and even numbered groups are selected via the main A-channel PAN P24, as are the left and right mix buses. (The sixth stereo bus is the MIX-B bus, with it's own independent pan control P20; see section 3.7 "B-channel"). Usually, only one of S28 to S31 will be selected for a particular channel (See block schematics).

- 👉 An exception to this rule is when laying down voice takes. It is often convenient to have the mic channel(s) routed to all potential TAKE tracks simultaneously, since you are often dropping in quickly between four or more tracks. It means one less button press each time you switch tracks.

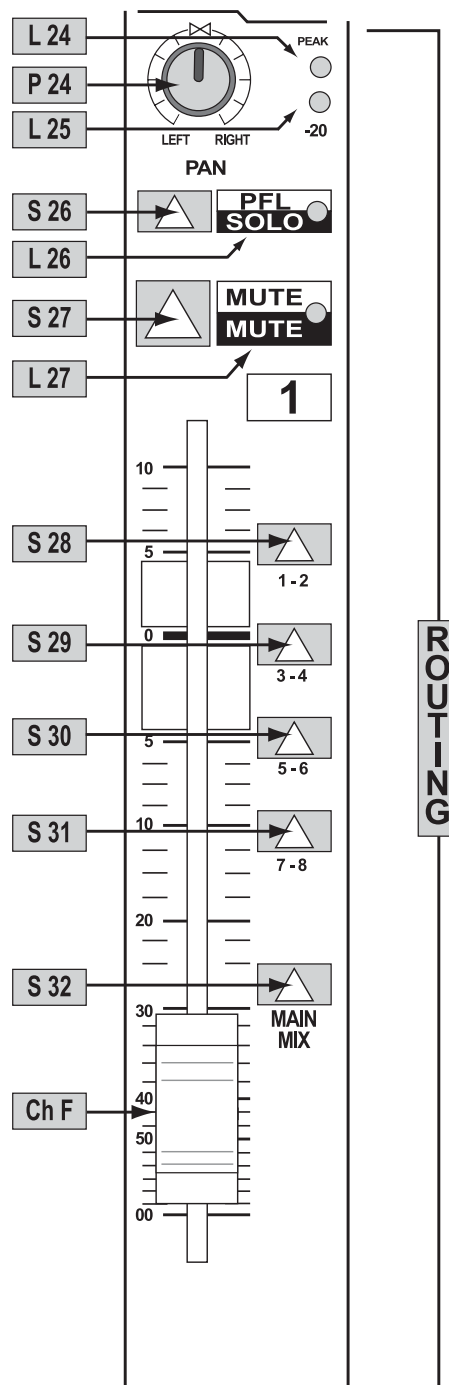

Fig. 3.5: Routing

The level to the subgroup and main mix buses is ultimately determined by the channel faders. These are designed to give a smooth logarithmic taper of a type more usually associated with the name of some pretty expensive brand ... The low level performance particularly is far smoother than that of a normal “budget” fader.

The MUTE button (S27), like that for SOLO has an LED indicator (L27) and removes the A-channel signal from all buses, save any auxes set to pre fader. It is ergonomically placed immediately above the fader and engaging MUTE is equivalent to setting a fader level of minus infinity.

3.7 B-channel

The B-channel (fig 3.6) comprises a secondary channel with its own high and low EQ, pan and level (P18, P19, P20 and P21). The EQ is a replica of the A-channel shelving EQ. The B-channel ALWAYS feeds into the MIX-B stereo bus, but its source can be switched between TAPE, LINE, MIC and A-CHANNEL, depending on how S1, S3 and S23 are set (see fig. 3.2 and section 3.2). Unusually for an 8-bus console, B-channels also have

their own MUTE buttons (S22). Aux sends 3/4/5/6 may be diverted from the A to the B-channel via S17. Therefore, if the B-channel is being used to monitor off-tape, some FX processing e.g. reverb and echo can still be applied. (See section 16.3 “Wet monitoring”.)

 **When B-channel looks at A-channel (S23 DOWN), the signal comes A-channel mute switch and pre fader. A modification can convert this PRE stereo aux send to POST fader. (See APPENDIX II “Modification No. 2”.)**

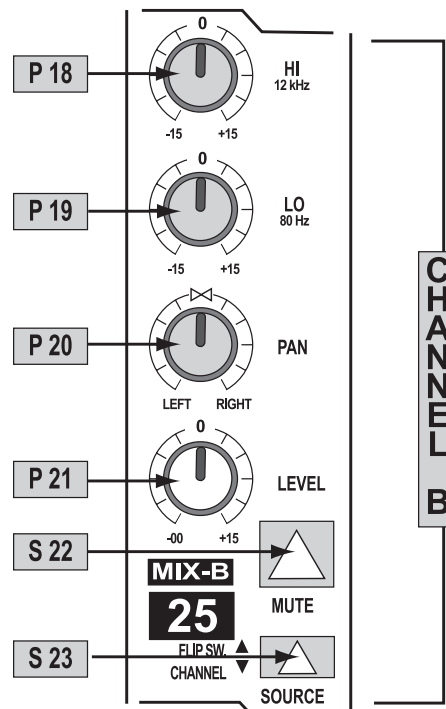

Fig. 3.6: B-channel

4. INSERTS

Insert points are useful for adding dynamic processing or equalization to a channel, subgroup or the mix. Unlike reverbs, etc., which are usually added to the dry signal, dynamic processing is normally applied across an entire signal. Here, an aux send would be inappropriate. Instead the signal is intercepted somewhere along the channel/subgroup/mix, fed through the dynamics processor and/or EQ and then returned to the console at the same point where it left. The insert point is invisible or normalized, until a jack is plugged into it.

All subgroups and channels have got insert points, as does the main stereo output. Both SEND and RETURN are accommodated on a single stereo 1/4" jack socket wired tip=send, ring=return. Inserts are always pre fader and also pre EQ / aux sends for channels.

Insert points may also be used as pre EQ direct outputs without interrupting the signal flow. This is obvious when looking at the patchbay wiring (section 8, fig. 8.1). If you want to insert a dynamics processor post EQ, the insert point must either be taken from a subgroup, or via a second channel / aux return as follows:

- a) Insert a compressor/gate/EQ across a subgroup, and route the channel to be processed (and only that channel) to that subgroup.
- b) Alternatively, patch a channel's direct out into a compressor/gate/EQ. Take the output from that compressor/gate/EQ and feed it back into the desk via a secondary input (channel, aux return, etc.).

Figure 4.1 illustrates how you might insert into a channel post EQ for mixdown or track-laying (their requirements are different). Mixdown requires one A and one B-channel. Recording requires two A-channels.

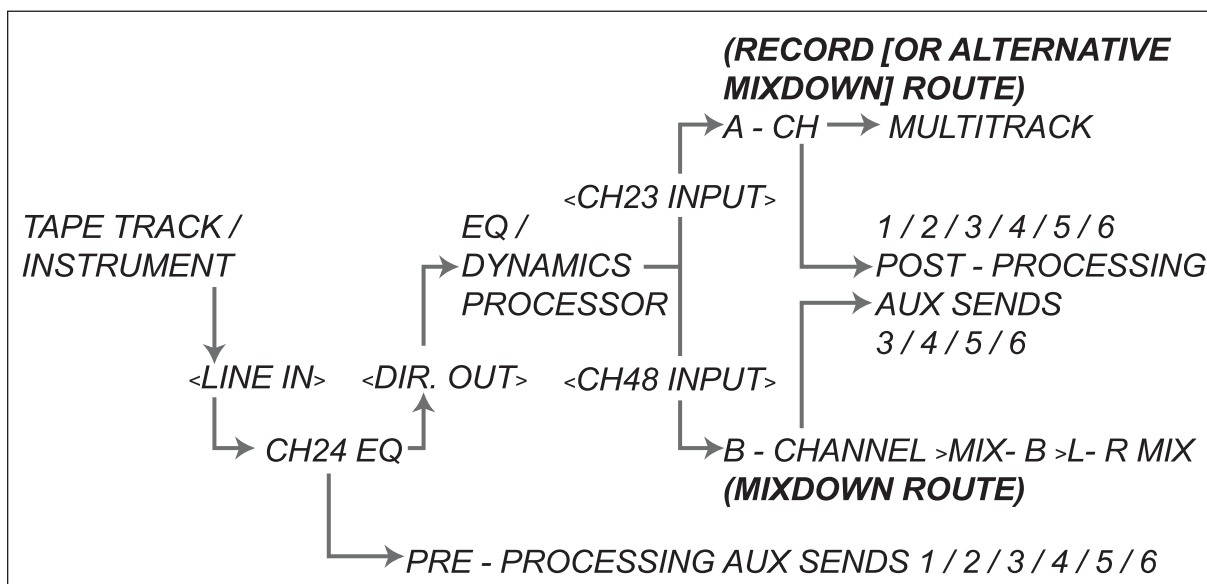

Fig. 4.1: Post EQ channel insert

👉 In this arrangement you might find that compression tends to soften the perceived amount of EQ applied. The solution? Apply more EQ. This creates a real “pressure” sound, great for high energy music such as dance. (For a more subtle approach, use the desk insert points word for word.)

👉 Using a group insert to effect post EQ processing precludes the use of POSTPROCESSING AUX SENDS without some serious re-patching.

5. SUBGROUP AND DIRECT OUTPUTS

5.1 Subgroups

The principal routes to the multitrack are via the SUBGROUP OUTPUTS. There are four stereo (or eight mono) subgroups, numbered 1 to 8. All main channels can access all of them, as can the STEREO AUX RETURNS 1 and 2. (For this reason it is usually wise to bring your best two FX processors back on these returns (or A-channels, for that matter), so that they can easily be sent to tape. (See also section 6.1 “Aux masters”.)

Why are there 16 subgroup output jacks on the EURODESK when there are only 8 subgroups? Well, each subgroup output is duplicated, so that the EURODESK can interface with up to 16 tracks via the group outputs without having to re-patch.

As well as always functioning as subgroups for track laying via the SUBGROUP OUTPUTS, groups can be routed directly into the main mix bus for submixing. Main mix routing is handled by switches S37 and S38. S37 routes an odd numbered group to the left bus, while S38 sends an even numbered subgroup to the right bus. That’s fine for stereo submixes. If you want a pair of mono submixes instead, also press the MONO buttons (S35 and S36). Now these subgroups feed into the center of the main mix stereo image, i.e. equally to L and R. You could have the first subgroup feeding into the left hand side, while the second one appeared in mono, but I can’t think of many real situations where you’d want to do this.

Subgroup SOLO (S33 + S34) follows the mix assignment. E.g.: If the main mix is selected, then that stereo subgroup will be monitored in stereo. If mono is also selected, monitoring is in mono.

👉 Try inserting compression / de-essing / an exciter / a gate across grouped signals (e.g. backing vocals, drums, layered synths).

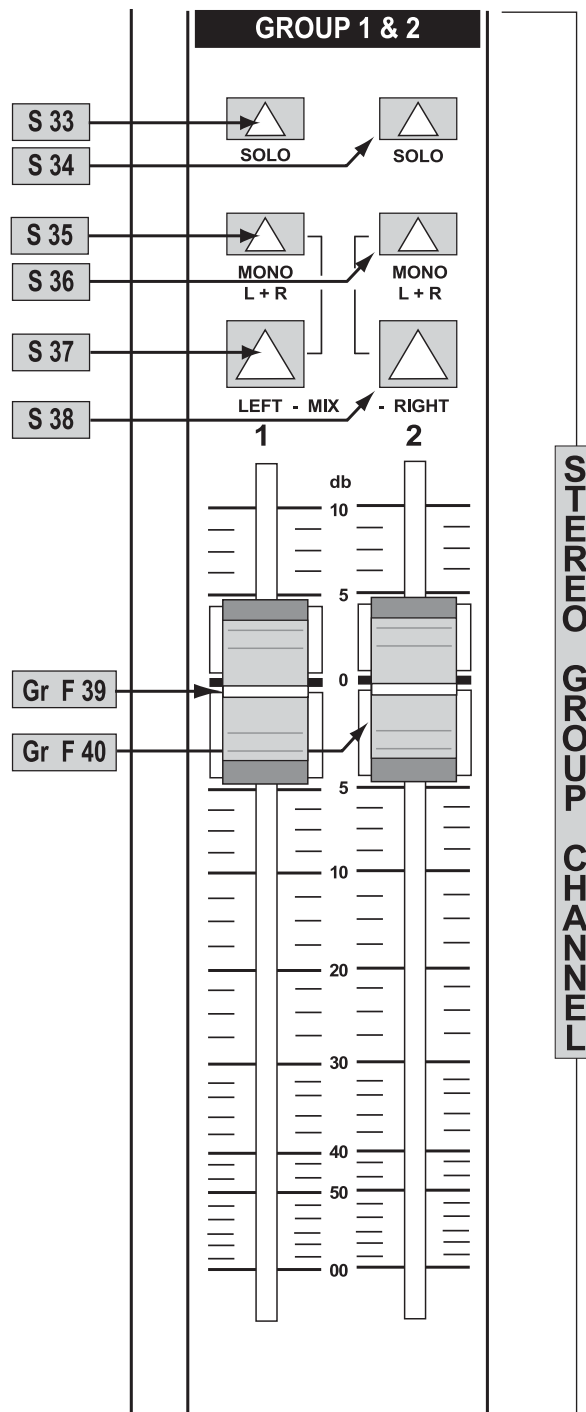

Fig. 5.1: Stereo subgroup channel schematic

- ☞ Try merging a dry signal with a little wet, then compressing the sum heavily. Though the reverb proportion will be low when a signal is present, the resultant reverb tail pumped up by the compressor at the start of each silence will give the illusion that the reverb was massive all the time. (The listener will be left wondering how the singer could sound so clear in such a wet acoustic!)

- ☞ EURODESK insert points are, of course, simultaneously inputs and outputs. Get them onto a patchbay, where they can appear as independent sockets, and do away with all these fiddly Y-leads that always seem to be the first to get knotted in the flightcase. (See section 8 “Patchfield”.) Now it is possible to do the following incredibly useful patch without having to make up what would amount to a ring-to-tip, tip-to-ring stereo patch lead.

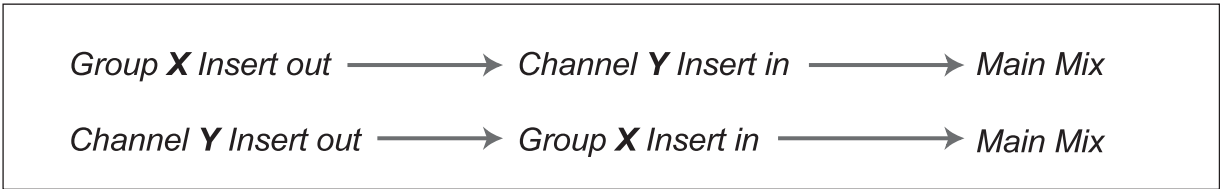

Fig. 5.2: Using insert to add channel EQ to subgroup output (while keeping the number of line inputs unchanged!)

5.2 Direct outputs

Each of the 24 main channels on the EURODESK MX9000 has its own DIRECT OUTPUT, which is taken from a point immediately after the fader (i.e. post EQ and after the aux sends, see block schematics). This can feed a tape track directly without having to resort to the subgroups, enabling more than eight different tracks to be recorded simultaneously. Almost alone among the EUROjacks, these are on unbalanced mono sockets at +4 dB. (See section 23, also section 16.1 “Recording”.)

6. MASTER PANEL

6.1 Aux masters

6.1.1 Aux sends

Much of the master section is taken up by master aux sends and returns. We’ll start with the sends (see fig. 6.1.1).

Stacked in a vertical column are six master aux send levels, one for each of buses 1 to 6 (P41 to P46). Each one has a gain structure of minus infinity to +15 dB. The extra 15 dB of gain comes in once a knob passes a center detente (representing the “normal” unity gain position), enabling insensitive outboard FX to be properly driven. Each aux send has a SOLO button (S41 to S46), and, as with other areas of mixer, a LOCAL SOLO LIGHT (L47), which illuminates when any of the AUX master sends are solo-ed. This is to help you see exactly what has been solo-ed. Any experienced engineer will have had occasion to search painstakingly through every solo button on his/her console trying to find out why the main solo light was on, and the control room monitors silent!

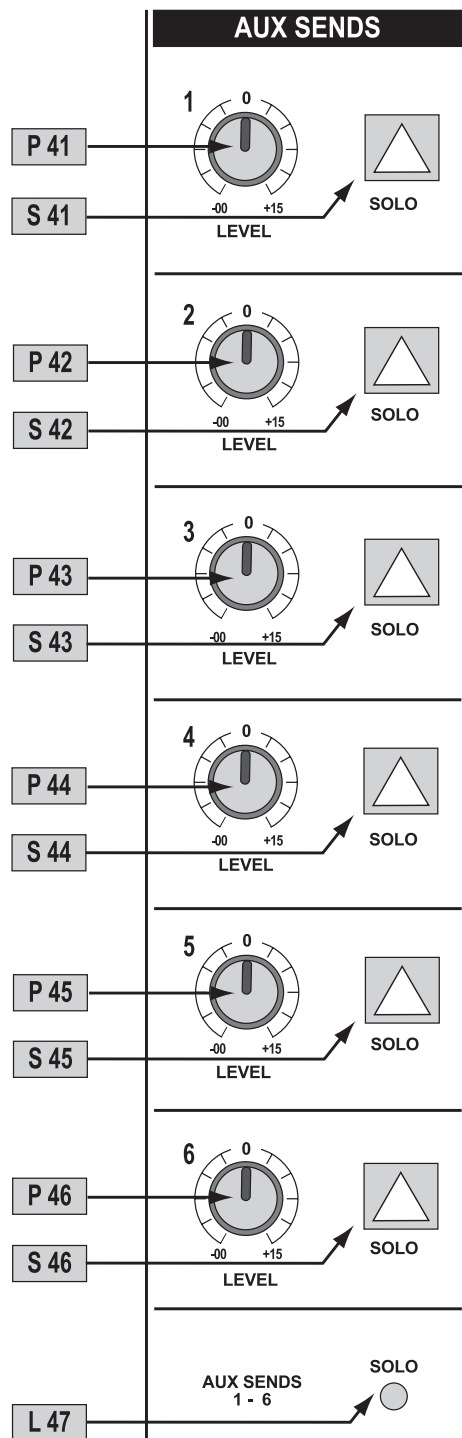



Fig. 6.1: Aux sends

6.1.2 Aux returns

Next to the aux sends are the stereo aux returns (see fig. 6.2). These can be thought of as a dozen extra line inputs configured as six stereo pairs. On these inputs there is up to 20 dB of gain available. Alternatively, a mono (center-panned) signal may be returned by plugging into the left aux return jack only.

 **This feature is disabled if all line-level I/Os from the EURODESK are wired permanently to a patchbay (see section 8).**

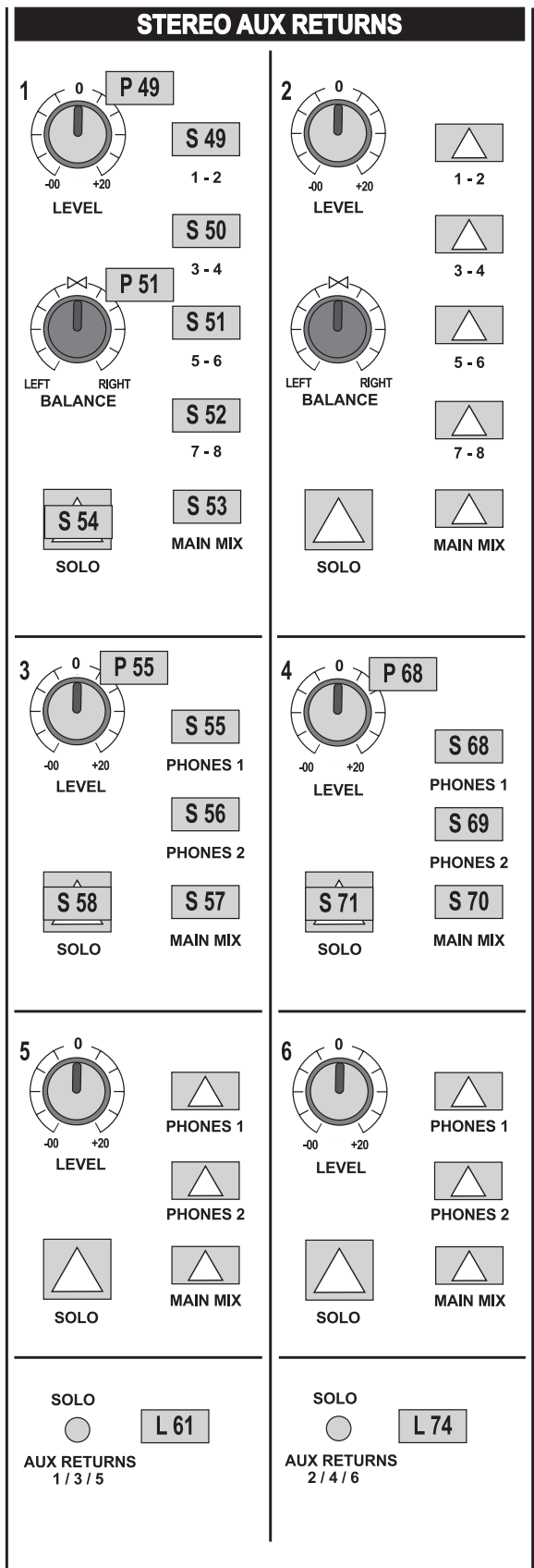

Fig. 6.2: Stereo aux returns

a) Aux returns 1 and 2

Aux returns 1 and 2 have full subgroup routing matrices to enable returning FX to be sent to tape, plus main mix bus assignment. The functions for aux return 1 (mirrored by aux return 2) are: ROUTING (S49/50/51/52/53) LEVEL (P49), BALANCE (P51) and SOLO (S54). LEVEL controls the amount of signal being blended into the mix or a subgroup, while BALANCE controls the relative amounts of L and R processed signal. We doubt if you'll often want to adjust BALANCE away from center.

👉 **As always, there are exceptions to -above rule. Some short stereo delay effects (say 30 ms to L, 50 ms to right) cause a psychoacoustic effect where the earlier delay seems louder. A similar effect is noticeable when harmonizing in stereo: a slight pitch shift upwards will seem louder than one that goes down. In both cases use the BALANCE control (P51) to compensate.**

👉 **When carrying out the above mentioned information, or any other stereo imaging exercise, don't just rely on the control room monitors. Get a pair of headphones and listen in stereo and in reverse stereo, to allow for any hearing discrepancy between your ears.**

b) Aux returns 3 to 6

And so to aux returns 3 through 6. These too have a routing matrix (S55 to 58 for aux return 3), but this time it is designed to facilitate monitoring rather than recording. The options are MAIN (L/ R) MIX, and PHONES 1/2. Gain pots and solo switches complete the picture.

c) SOLO

Below each column of aux returns lies a local solo LED (L61 & L74). These illuminate whenever a SOLO button in the column above is pressed.

There is no absolute reason why the send from aux 1 should feed into a processor whose outputs are sent to the aux return 1. The processor could just as easily be patched into the aux return 3, or even a pair of channels. For many purposes, however, it is sensible to set up a default patch where the aux outputs and inputs correspond. It is logical to put your premier FX units into the aux 1 and aux 2 loops, since these returns enable you to record to tape without re-patching.

👉 **An exception to the above is when recording a group of performers live to multitrack. (See section 16.3 "Wet monitoring").**

👉 **Sometimes an engineer wants to narrow the stereo width of a reverb field. To do this you will have to come back on either A or B-channels, which have full PAN facilities.**

6.2 MIX-B master

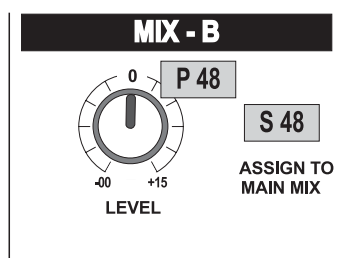

Fig. 6.3: Mix-B

Only two controls occupy the MIX-B master (fig. 6.3). P48 offers the standard EURODESK gain of up to +15 dB. S48 is crucial: it routes the MIX-B bus output into the main mix bus. MIX-B can have three basic functions:

It can act as an entirely separate mixer-within-a-mixer to provide a completely separate mix (S48 UP, S23 DOWN). (See also section 17.)

It can act as an additional stereo aux feed to FX as well as a pre fader monitoring aid during mixdown (S48 UP, S23 DOWN).

It can provide 24 extra B-inputs to the mix (S48 DOWN, S23 UP).

☞ For live applications try using MIX-B to feed a secondary set of speakers. These could be sidefills, or even more spectacular, the rearward portion of a quadraphonic sound system.

There is no SOLO provision for MIX-B. However, you can audition it by selecting only MIX-B (S83) in the monitor sourcing matrix.

☞ If MIX-B is assigned to the main mix (S48 DOWN), do not listen to MIX-B (S83) and the main mix (S82) simultaneously. That way you'll be monitoring MIX-B twice over, and what you hear won't correspond with what's going down to tape.

6.3 Monitoring

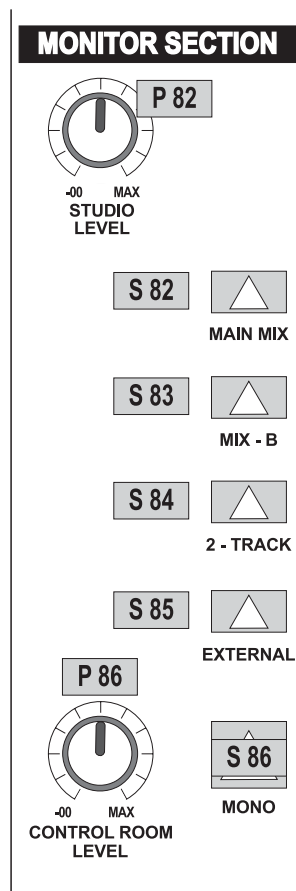

Fig. 6.4: Monitoring

Though most of you will want to audition the main mix most of the time there are exceptions. These include PFL/SOLO, and 2-TRACK PLAYBACK. The SOURCING matrix (S82 to S85, see fig. 6.4) allows you to monitor the main mix, the MIX-B and two external sources marked 2-track and EXTERNAL. The master meters follow whatever source is being auditioned. The meters won't make much sense if more than one source is selected!

☞ EXTERNAL could be "normalled" to a HiFi pre-amp, allowing you to monitor extra sources such as vinyl, cassette, CD, etc.

☞ Altering what goes into the control room's monitors does not affect the signal from the main recording outputs. Just as well, or every time you wanted to do a quick SOLO during a mix, you'd have to start again!

The CONTROL ROOM LEVEL pot P86 sets the level to the control room monitors. This is sourced post the main main mix stereo fader setting: otherwise you wouldn't be able to hear your fades. There is also a similar STUDIO volume pot (P82).

👉 Owners of MIDI production suites might like to drive a second pair of control room speakers from the studio output, but take care when using the TALKBACK mic: no -20 dB offset is applied to the studio output!

We would like to recommend you to use half-a-dozen sets of speakers on an external switching matrix, including studio monitors, ghetto blaster, club system, car stereo and overblown 2" speakers loosely screwed into a less-than-airtight cardboard box.

👉 If you are using the STUDIO output to drive a pair of monitors actually in the studio, do not ever leave P82 turned up during a take. Howls and howlround may well be the result.

Lastly, there is a MONO button (S86), useful for checking the phase correlation and/or coherence of a stereo signal. Again, this does not affect the main mix output.

6.4 Headphones

Both HEADPHONES 1 & 2 masters are identical.

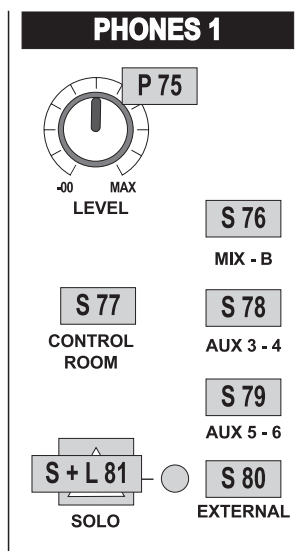

Fig. 6.5: Phones

A SOURCING matrix picks up any or all of MIX-B (S76), CONTROL ROOM (as chosen in monitor section, S77), AUX 3/4 (S78), AUX 5/6 (S79) and EXTERNAL (S80). In addition to the sources which are directly selectable from the headphones masters, aux returns 3 to 6 may be “force-fed” into HP1 & HP2 from the aux returns masters (S55, S56, etc.).

The headphone mix level is controlled by a master volume pot (P75), and the gain is sufficient to drive headphones directly. This is fine for a MIDI suite with overdub booth, but for the bigger studio's headphone network we'd recommend using a separate headphones distribution amplifier like our BEHRINGER POWERPLAY PRO HA4400. This can offer the added advantage of independent headphones level control for every performer.

A SOLO button (S81), with its own LED, enables monitoring of the headphones amplifier's output signal.

This way the engineer can monitor what's going on in the cans on the control room monitors, though in our experience this does not give as true a picture as auditioning the cue feed from a set of headphones identical to those worn by the performer(s).

6.5 PFL/SOLO

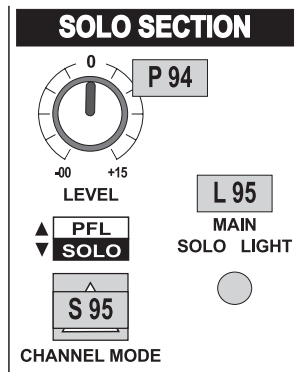

Fig. 6.6: Solo section

6.5.1 PFL

Pressing S95 disengages the stereo SOLO bus, and replaces it with a separate mono PFL (Pre-Fader-Listen) bus. Now anything at all which is SOLOed, isn't. It is PFLed instead. PFL should be used for gain-setting. (See also the essential section 13 "Start-up".)

6.5.1 SOLO

SOLO is short for SOLO IN PLACE, and is the preferred method for auditioning an isolated signal or a group of signals. Whenever a SOLO button is pressed, all unselected channels are muted in the monitors. Stereo panning is maintained. The SOLO bus is derived from the output of the channel PANs, aux send/return pots, etc., and is always post fader.

In addition to any local solo LEDs which might be activated, the ultra-bright MAIN SOLO LED (L95) illuminates whenever anything is SOLO/PFLed. P94 controls the master SOLO/PFL level. Set to unity gain (center detente), this will match the mix level.

6.6 Talkback

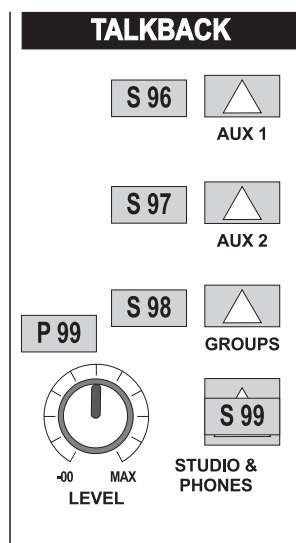

Fig. 6.7: Talkback

The built in mic (above the main mix faders) allows you to converse with artists remotely. The most important controls are the VOLUME (P99) and PHONES & STUDIO button (S99, see fig. 6.7). It is possible to route the talkback mic to any of the following: aux 1, aux 2, subgroups, and phones and studio (S96 to S99).

Complex headphone or stage monitoring networks could be constructed where HP1, HP2, aux 1 (pre), aux 2 (pre) and one or more subgroups all feed separate monitor mixes. (See section 16.2 "Very tricky headphones").

However, since the four pushbuttons are non-latching it might drive you crazy. If you are using many headphone feeds, you may find it easier to patch a separate microphone for talkback straight into a channel, where it can be routed pretty much anywhere.

Engaging TALKBACK (S99) dims the control room (monitors, not lights you fool) by -20 dB to restrict the possibility of feedback. All other talkback routes are unaffected.

7. CONNECTIONS

7.1 Rear panel

Expander port bus inputs

If you want to add another console to your EURODESK MX9000, the expander port bus inputs give access to all subgroups, auxes and mix busses via an array of 1/4" jacks, situated top left on the rear panel.

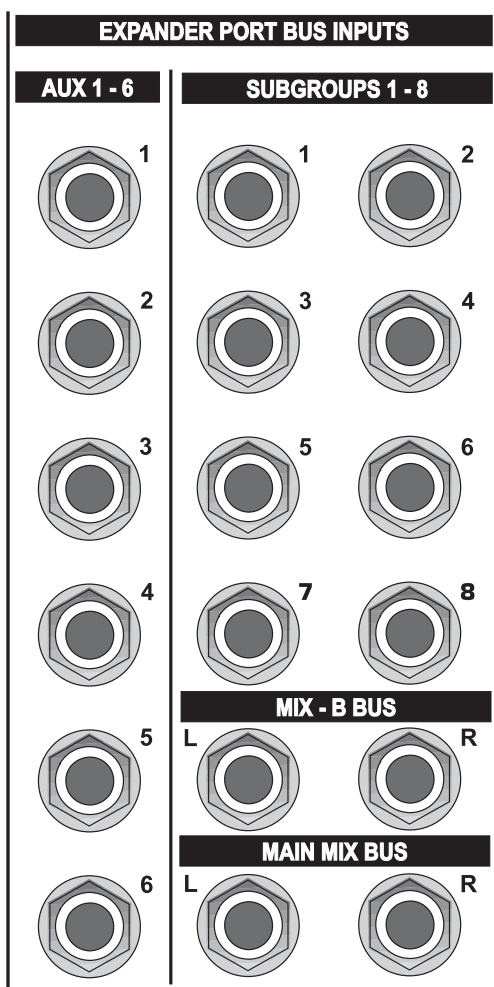

Fig. 7.1: Expander port bus inputs

PSU

The chunky remote 19" racked power supply is connected via a circular multiway (DC POWER IN) at the bottom left-rear of the console. This supplies several DC operating voltages incl. +/-18 V (audio circuits), +48 V (mic phantom power), +12 V (BNCs) and +5 V (LEDs).

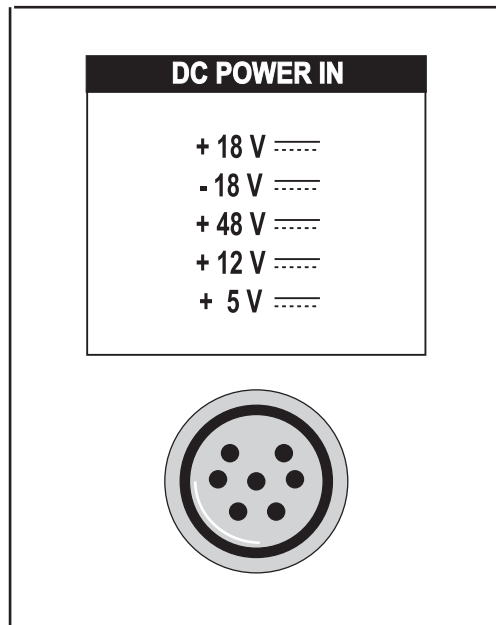

Fig. 7.2: Power supply unit connector

Auxiliary sends

Unbalanced 1/4" jacks, wired tip = signal (+ve) and sleeve = ground/screen. They operate at +4 dBu.

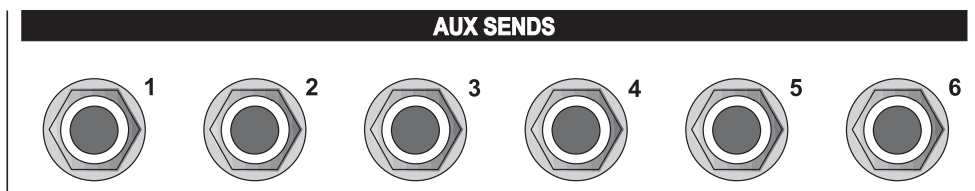

Fig. 7.3: Auxiliary sends

Auxiliary returns

All six stereo pairs, to be located immediately below the aux sends, are on unbalanced 1/4" jacks and operate at 0 dBu.

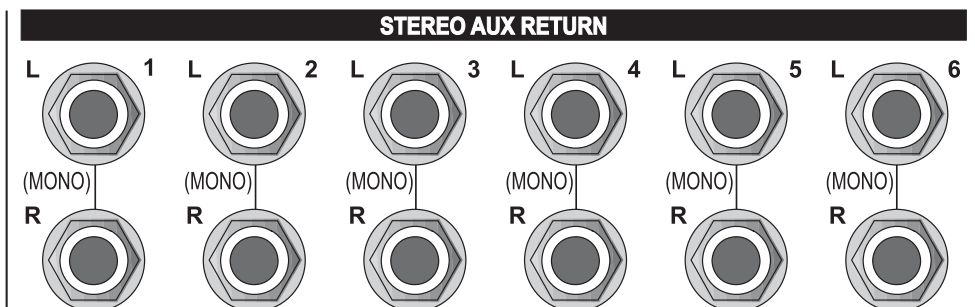

Fig. 7.4: Auxiliary returns

Subgroup inserts

Unbalanced send and return from a single stereo jack socket, wired tip = out, ring = in and sleeve = ground/screen.

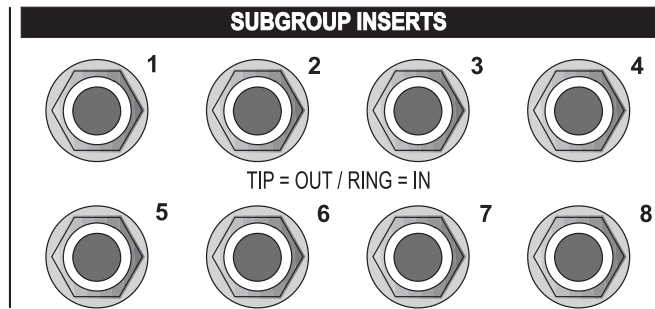

Fig. 7.5: Subgroup inserts

2-track in/out

RCA sockets for use with tape recorders, etc., signal = main mix, wired center post = signal (+ve) and sleeve = ground/screen.

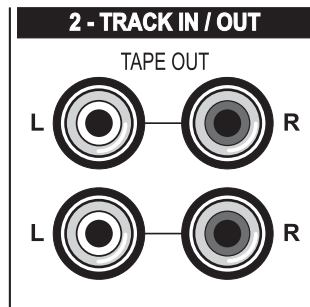

Fig. 7.6: 2-track in/out

2-track/external inputs

Two additional stereo inputs, this time on unbalanced 1/4" jacks, wired tip = signal (+ve) and sleeve = ground/screen.

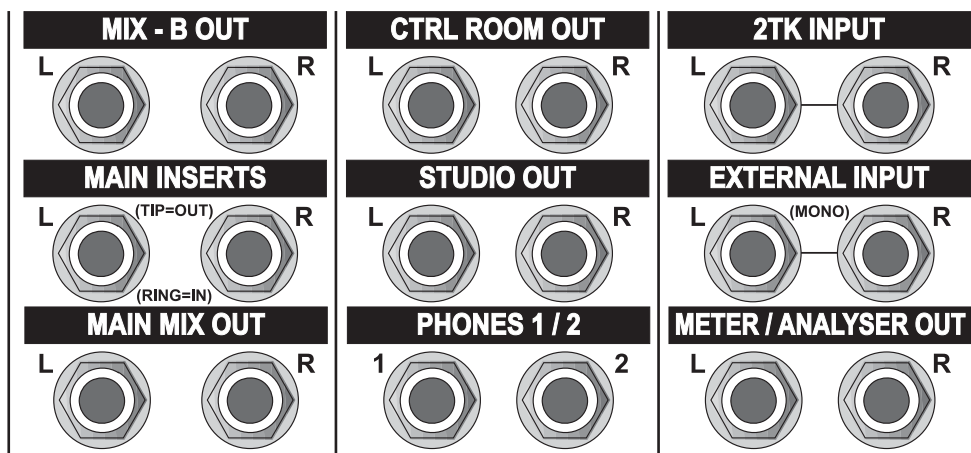

Fig. 7.7: Additional connectors

Main inserts

As above, but for the main mix.

Stereo outputs

The control room output (monitors) main mix, MIX-B and studio output are all on a pair of unbalanced 1/4" jacks, nominal output level +4 dBu. The main mix is also available as a fully balanced pair.

Phones 1/2

These are on stereo jacks, wired tip = left signal, ring = right signal and sleeve = ground/screen (see section 6.4 "Headphones").

Meter/analyzer out

Unbalanced jacks at +4 dBu for use with external measuring equipment, e.g. the built-in real-time analyzer of our BEHRINGER ULTRA-CURVE PRO DSP8024 (signal = master LED meters).

Master balanced outputs

Balanced XLR for connecting to the mastering recorder. Wired pin 1 ground/screen, pin 2 hot and pin 3 cold. Maximum level is +28 dBu.

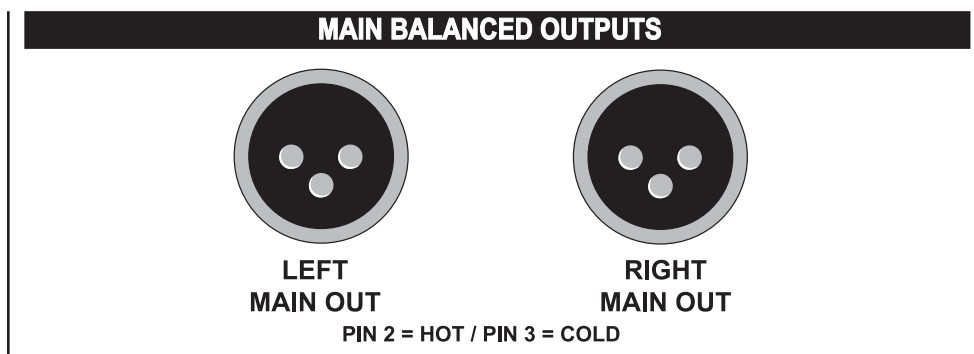

Fig. 7.8: Main balanced outputs

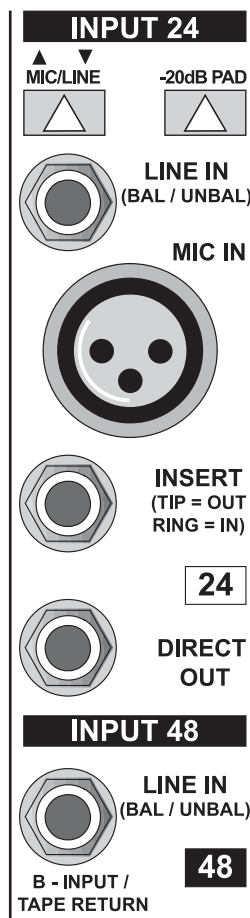



Fig. 7.9: A and B-channel input section

A-channel line inputs

The A-channel line inputs accept balanced or unbalanced 1/4" jacks, tip = hot, ring = cold and sleeve = ground/screen.

Mic inputs

These are via XLR-type connectors, wired pin 1 = ground, pin 2 = hot and pin 3 = cold, for balanced low-level operation. Since most quality capacitor microphones require a 48 V DC offset to charge the plates, phantom power is provided and can be switched on or off in three blocks of eight via a switch situated below channels 8, 16 and 24.

 **Care should be taken not to plug microphones into the console (or stagebox / wallbox) while the phantom power is on. Also, mute the monitor / PA speaker when turning phantom power on or off. Allow one minute after powering up for the system to equilibrate before setting input gains.**

Channel inserts

These provide for unbalanced send and return from a single stereo jack socket. Wiring is: tip = out, ring = in and sleeve = ground/screen.

Direct outputs

This tap comes from just after the channel fader. Unbalanced 1/4" jacks.

B-channel inputs/tape returns

They also accept balanced or unbalanced 1/4" jacks and are switchable, in groups of eight, between -10 dBV (unbalanced) and +4 dBu (balanced), corresponding to the standard semi-professional and professional operating levels and configurations respectively. Consult your multitrack manual to find out which one applies.

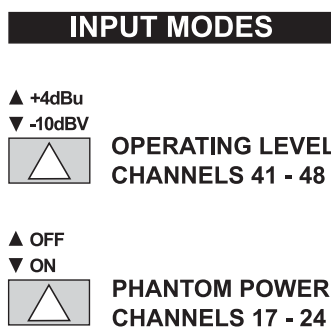

Fig. 7.10: MIX-B operating level switch and phantom power switch

Subgroup outputs/tape sends

The eight subgroups are each connected to two stereo jack sockets, for easy patching into 16 track recording systems (or 24 track, if you use Y-adaptors). Once again, the operating level is switchable between +4 dBu and -10 dBV in two banks of (2x) 4.

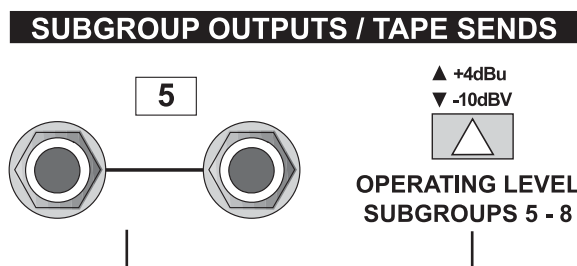
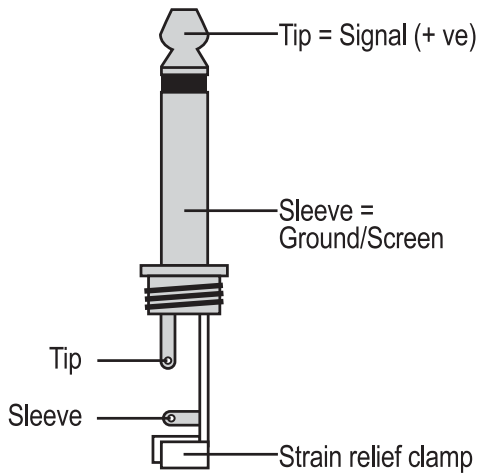

Fig. 7.11: Subgroup outputs/tape sends and operating level switch

7.2 Plug soldering guide

You will need a lot of cables for a lot of purposes. Here's how they should look:

1/4" mono (TS) plugs



You'll need this kind for:
Expander Port Bus Inputs
Subgroup Outputs /
Tape Sends
Direct Outs
Aux Sends
Control Room Output
Main Mix Out
Mix-B Output
Studio Output
Aux Returns
2-Track Input
Meter/Analyzer Out

1/4" stereo (TRS) plugs

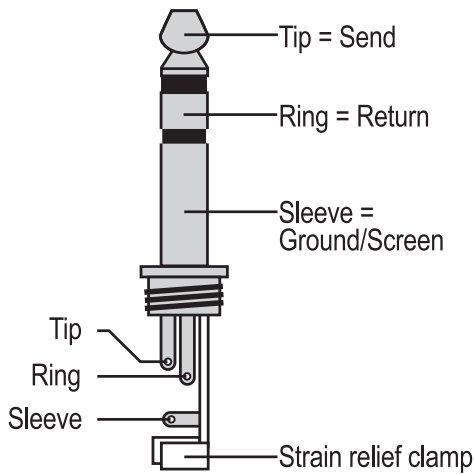

You'll need this kind for:
Inserts
Subgroup Inserts
Main Inserts

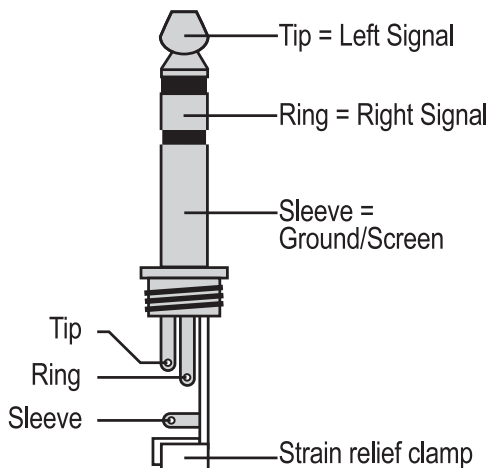

You'll need this kind for:
Headphones

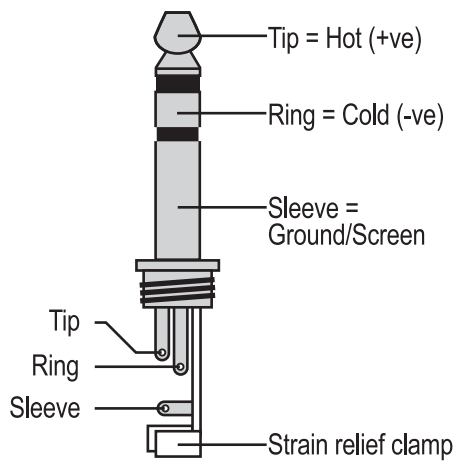

You'll need this kind for:
 Line In
 Inputs-B/
 Tape Returns

Maybe you will need this 'Y' shaped thing for Insert purposes

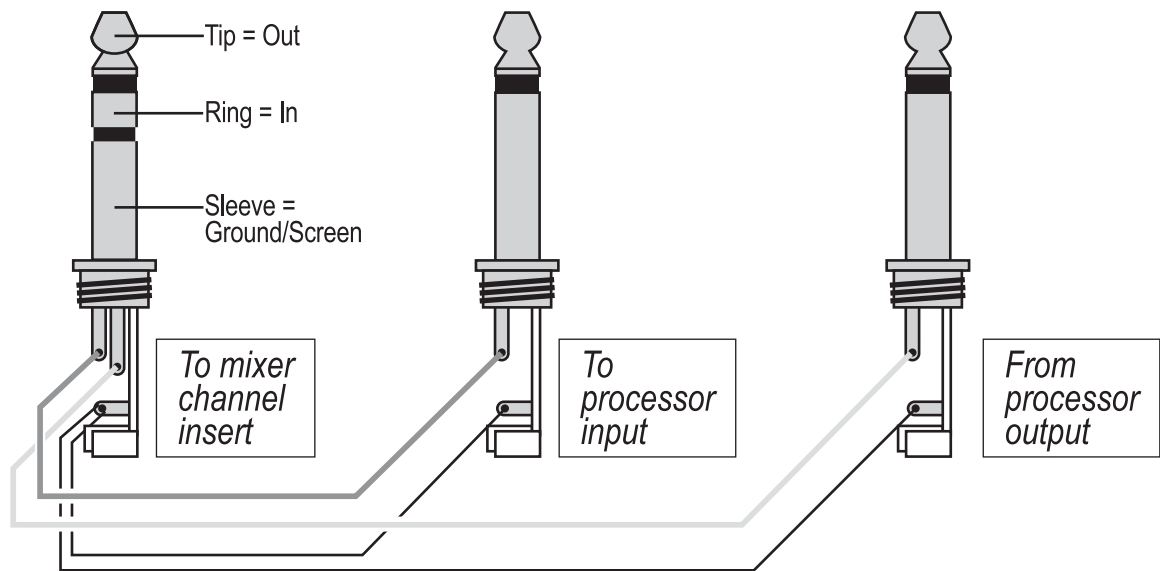

Female XLR plugs ('soldering' view of the cable connector)

- 1 = Ground/Screen
- 2 = Hot (+ve)
- 3 = Cold (-ve)

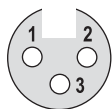

You'll need this kind for Main Balanced Outputs

Male XLR plugs ('soldering' view of the cable connector)

- 1 = Ground/Screen
- 2 = Hot (+ve)
- 3 = Cold (-ve)

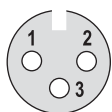

You'll need this kind for Mic inputs

Be sure to read sections 8 and 12 BEFORE you start heating your soldering iron!

8. THE PATCHFIELD

Nomenclature clarification:

▲ FIELD = entire patching area

▲ BAY = a unit of 48 jack sockets arranged as 24 outs over 24 ins

If you really want to make the most of your home studio, invest in a patchfield. We know that you will often put off doing a complex patch if there is no patchfield:

- 1) because it's so much bother and
- 2) in case you inadvertently damage or pull out a lead.

8.1 The normalized bay

Most decent jackbays offer two rows of 24 normalized jacks in a 1 U of rack space. Lucky you've got a 24/48 channel desk, eh? The term normalized refers to the fact that the top row (outputs) are internally connected to the bottom row (inputs), unless you plug something into an input socket. Plugging into the output socket of a normalized insert pair does not break the internal connection, but it does provide an alternative direct output. Where normalizing is not wanted on a patchbay (there are a few cases!) it is possible to remove it by cutting certain PCB tracks. Refer to the patchbay instructions for how to do this.

8.2 The patchfield

If you want to do the only decent thing and construct a patchfield for your studio, here's how to do it. Note that we have laid it out in order that a minimum number of cables are likely to be needed. We have also completely left out the microphone inputs. Unlike everything else, these operate at a level several orders of magnitude lower than line (+4 dBu or -10 dBV). It is best to plug microphones directly into the EURODESK MX9000, or via special XLR-type wall boxes connected to the EURODESK microphone inputs by a good quality balanced (2-core + screen) multicore. (See also section 12 "(UN)BALANCED LINES".)

*

Break the normalizing on this bay.

**

Tie lines: usually, in a MIDI setup, racks and keyboards etc. are scattered around the control room. Plugging these directly into the front of the patchbay would result in Spaghetti Junction. Instead, it is better to connect TIE LINE jacks to wall boxes strategically positioned near to where MIDI hardware congregates.

It's always good to have a few 4-way links around for splitting signals up to 3 ways (one in, three out). E.g. one tape track has four different instruments on it. Patch the DIRECT out of its CHANNEL into a 4-way split, returning to a further 3 channels via LINE INPUT. Set up each of the paralleled 4 channels for one instrument, and use mutes (preferably MIDI controlled) to mute the 3 unwanted channels at any one time).

 **Break the NORMALIZING LINKS on positions 21 - 24. Note also that the MIX-B outputs are adjacent to the aux sends. This is because one of the two functions of MIX-B (source switches set to CHANNEL) is to provide an extra stereo aux send.**

 **You can treat MIX-B as two mono sends using GAIN for level and PAN for blending. Setting pan to the center will give a 50/50 ratio of the "aux 7" and "aux 8" effect, hard left 100% "aux 7", etc.**

Break NORMALIZING LINKS here. If you've got more than 5 or 6 stereo dynamics/EQ processors, you might spill over onto another dedicated bay, or alternatively have to find some suitable extra space somewhere else in the patchfield. Remember, most dynamics processors also have sidechain/KEY inputs, and therefore require 3 holes per channel.

 **Enhancers are usually applied across INSERTS like compression and EQ etc., but most BEHRINGER enhancers have a SOLO mode, in which they can be addressed via an aux send and blended back into the main mix like any other reverb.**

Bay 1	out 1 2 3 4 5 6 7 8 9 10 11 12 13 14 15 16 17 18 19 20 21 22 23 24 channel direct outs (see*)
	neutral 1 2 3 4 5 6 7 8 9 10 11 12 13 14 15 16 17 18 19 20 21 22 23 24 tie lines (see*)
Bay 2	out 1 2 3 4 5 6 7 8 9 10 11 12 13 14 15 16 17 18 19 20 21 22 23 24 group outputs
	in 1 2 3 4 5 6 7 8 9 10 11 12 13 14 15 16 17 18 19 20 21 22 23 24 multitrack tape, hard disk recorder and/or sampler inputs
Bay 3	out 1 2 3 4 5 6 7 8 9 10 11 12 13 14 15 16 17 18 19 20 21 22 23 24 multitrack tape outputs
	in 1 2 3 4 5 6 7 8 9 10 11 12 13 14 15 16 17 18 19 20 21 22 23 24 Eurodesk tape returns
Bay 4	out 1 2 3 4 5 6 7 8 9 10 11 12 13 14 15 16 17 18 19 20 21 22 23 24 samplers, MIDI expanders etc.
	in 1 2 3 4 5 6 7 8 9 10 11 12 13 14 15 16 17 18 19 20 21 22 23 24 channel line inputs
Bay 5	out 1 2 3 4 5 6 7 8 9 10 11 12 13 14 15 16 17 18 19 20 21 22 23 24 aux outs Mix B time domain FX outputs neutral links: see ***
	in 1 2 3 4 5 6 7 8 9 10 11 12 13 14 15 16 17 18 19 20 21 22 23 24 time FX inputs stereo aux returns neutral links: see ***
Bay 6	out 1 2 3 4 5 6 7 8 9 10 11 12 13 14 15 16 17 18 19 20 21 22 23 24 channel insert sends
	in 1 2 3 4 5 6 7 8 9 10 11 12 13 14 15 16 17 18 19 20 21 22 23 24 channel insert returns
Bay 7	out 1 2 3 4 5 6 7 8 9 10 11 12 13 14 15 16 17 18 19 20 21 22 23 24 group — insert sends L R — EQ & dynamic processor outputs: see****
	in 1 2 3 4 5 6 7 8 9 10 11 12 13 14 15 16 17 18 19 20 21 22 23 24 break normalizing group — ins. returns L R — EQ & dynamic processor inputs: see****
Bay 8	out 1 2 3 4 5 6 7 8 9 10 11 12 13 14 15 16 17 18 19 20 21 22 23 24 L R L R L R Rec Mon Mon DAT1 HiFi DAT2 Cass CD Disc
	in 1 2 3 4 5 6 7 8 9 10 11 12 13 14 15 16 17 18 19 20 21 22 23 24 DAT1 DAT2 Cass L R Tuner Amp1 2-T in XTRN HiFi1 HiFi2 HiFi3 HiFi4

Fig. 8.1: Example of patchbay configurations

Bay 8:

L7 & R8 equals the L/R recording input to the 2-tracks. On Bay 8 we have hard-wired these to recording outputs 1 to 6 in order to drive all recorders simultaneously. Copying from any 2-track source to all recorders may be done by patching the source outputs into L7 and R8.

We have assumed you have a HiFi amp available to enable a variety of secondary sources to be condensed into the XTRN (external) input for easy monitoring selection via the HiFi amp's input selector switch, if you want to record from any of these sources, best patch direct from the individual outputs (17 to 22) rather than the HiFi amp mix (15 and 16) for the cleanest result. (The exception being vinyl, which will need to use the HiFi amp's RIAA pre-amp to present the mixer with a flat response signal).

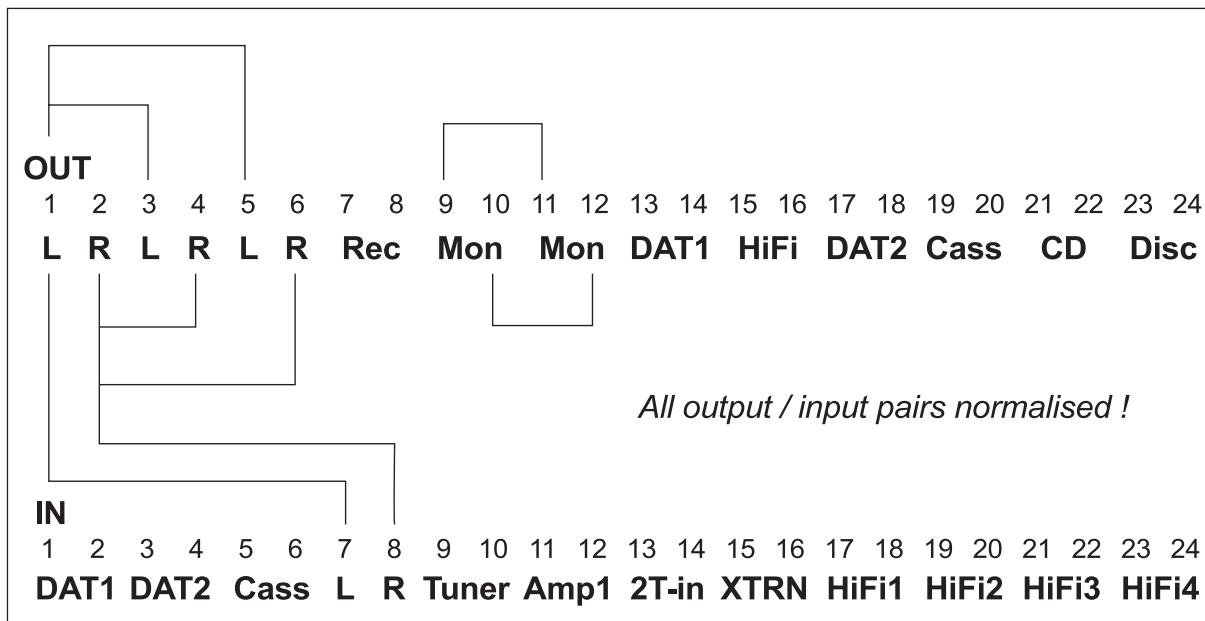

Fig. 8.2: Wiring for bay 8 (for advanced wiring scheme refer to section 11)

8.3 Looming problems

Loom wiring is an art in itself, and it is worth taking time out to get it right. First, it is important to avoid earth loops. (A looped wire acts as an aerial, picking up electromagnetic radiation.) Think of a tree: Every part of that tree is connected to every other part, but only by one route. That's how the total earth picture for your entire studio should look. Don't take the earth off your power cable plug to reduce audible 50 Hz mains hum (or its harmonics). Rather you should be looking at disconnecting the signal screen somewhere.

You could do worse than ensure that all screens are commoned at the patchbay in which case all unearthed equipment would pick up earth from this point via a single screen (more than 1 route = an earth loop), while mains-earthed equipment would have all screens cut at the equipment end.

👉 Some quality equipment has an independent signal and mains earth. In this case, at least one and possibly all screens should carry earth to the equipment. Sometimes the only way to find out is "suck and see".

Take care to ensure that using the patchbay does not disturb the studio's earth architecture. Always use short as possible patch leads with the screen connected at both ends.

If you're really serious about hum levels, you could run balanced lines wherever appropriate. The earth wiring scheme would be the same as before. By shorting the ring to the barrel for all balanced jack sockets connected to unbalanced equipment, you could use balanced patch leads throughout. (There is no percentage in wiring a balanced output to a balanced input with a mono patch cord!) (See section 12 "(UN)BALANCED LINES".)

Having designed mains hum out of the system, make up your cable looms from the patchbays outwards, and use cable ties, flexible sheaths, multicores etc. to keep the back of your racks tidy. It's going to get very busy in there, and loose cables will inevitably mean lost signals. Possibly even lost equipment!

9. EQUALIZATION

The variable parameters of the channel A and B equalizers on the EURODESK MX9000 are described in sections 3.4 and 3.7.

Few people buying the EURODESK will need to be told how an equalizer works. But how to get the best out of it? Well, that's another story.

In the beginning EQ was an instrument for removing unwanted frequencies, or compensating for imperfect microphone response curves, or bumps in a studio's acoustic. It was a corrective device. Tamla Motown turned that notion upside down in the sixties with the novel idea that you try to find for each instrument a characteristic frequency not shared by the other instruments in the mix. Then you whack up its gain. This makes individual voices punch through a mix in a slightly unnatural but exciting way. In general, corrective EQ usually involves broadband (slope) contouring, together with narrowband notching of unwanted resonances. The narrower the notch or "Q", the less the total signal will be affected.

 **Finding bad resonances is made easier by first frequency sweeping in boost mode.**

"Motown" EQ is achieved by applying boost in a fairly broadband way. The broader the band, the more musical but less instrument-specific the effect. Applying boost over a narrow bandwidth will sound "Honky". The two semi-parametric bands of the EURODESK EQ have had their Q fixed at 1, a typical and sensible value. For sounds which require drastic corrective EQ (remember no MIDI instrument should need it), it is advisable to have a couple of channels of fully comprehensive equalization in your rack. (You can always bounce tracks through the outboard EQ, freeing up the unit for the next task). Check out our BEHRINGER ULTRA-CURVE PRO DSP8024, which promises to be another price/performance buster.

The EURODESK EQ might be applied to a signal as follows: First, trim the LF and HF shelves to achieve the required slope or "LOUDNESS". (These controls mirror the tone controls of a typical HiFi amp.) Now use one parametric band to boost the nicest frequency, and another to cut the nastiest. Over all channels in the mix, if too many of the nicest frequencies coincide, then you might have to settle for second best in some cases! Often you might want to boost two nice frequencies. Really nasty frequencies will need notching. Time to go outboard.

Why does the upper mid bell frequency go up to 20 kHz? A more pertinent question might be, why has it taken so long to get there? After all, even 16 bit (the lowest acceptable quality) digital audio sports a 20k bandwidth: surely if 20k is important then so is controlling it. OK. You and I will never hear a pure 20k sine tone. However, Rupert Neve, the audiophile Guru, would argue that when it comes to real instruments, what happens even above 20k may have a perceptible effect on the listener. It seems that one reason why high-quality (1/2" at 30 IPS) analog tape sounds better than DAT to many discerning ears is because, although its frequency response begins to roll off at 12 dB/octave somewhere around 15 to 20 kHz, it is not abruptly cut off at 20!

We have heard, or "detected", a 20+ kHz low pass filter being switched in and out when monitoring an analog master tape through a speaker system that included piezo-electric tweeter elements capable of reproducing up to 40 kHz. Perhaps less controversially it can be shown that if cut/boost is applied at 20 kHz, a significant portion of the resulting EQ curve for all but the tightest of Q's actually occurs in the audible spectrum, below 16 to 18 kHz. For example if the BEHRINGER EQ is boosted by +15 dB at 20 kHz, the amount of boost at 10 kHz will be 3 dB. The resulting EQ curve will bear no relation to one where 3 dB of boost is applied at 10 kHz.

 **A good vocal signal can be enhanced by applying a significant boost in the 15 k region or higher, above the nasty sibilance region. Especially effective if you've got a de-esser post EQ.**

 **Use the LF cut to tighten up channels in a mix: maybe remove it only for the bass, kick drum, toms, tablas, didgeridu and other deliberate subsonics. (When recording classical music ignore this advice).**

 **With an LF cut at 100 Hz and a lo shelf boost at 80 to 160 Hz, you have pretty much got a peak response rather than shelving at the bottom.**

- ☞ **Look at the extraordinary width of the frequency sweep of the upper mid EQ -300 Hz all the way up. Set to maximum boost and play about with the frequency in real time. I bet you'll get some stunning filter sweeps. Try it on drumloops – great for dance music!**
- ☞ **You can cascade channel EQs by connecting the DIRECT OUT (see section 7 “CONNECTIONS”) of one channel into the LINE or TAPE INPUT of another. The first channel should first be un-routed to all buses, including L/R and aux sends. The second channel then becomes the “control” channel, routing to the buses. You now have a 23 channel mixer, but one channel has a 4-band (semi)-parametric plus 30 dB of shelving swing!**
- ☞ **Remember EQ contouring can be done with CUT as well as BOOST. E.g.: cutting away the top and bottom, then pushing up the gain is equivalent to MID-RANGE BOOST! EQ is NOT a 1-way street!**
- ☞ **Always re-set a channel's input gain after altering the amount of EQ cut or boost applied (see 3.3).**

10. GAIN OPTIMIZATION

PFL (Pre-Fader-Listening) is the way to set a desk level. Setting up the channel input gain is discussed in the essential section 13. Optimum master aux send levels will be dependent on the sensitivity of the FX device being driven, but unity gain is a useful starting point. As the mix progresses, more and more channels are likely to be sending to effects via the aux buses, and it's best to PFL all sends (aux, subgroup, MIX-B) just before setting up for the final mix.

Outboard reverbs etc. should all be made to work hard. There's no point in having an 85 dB dynamic range if the input meter of your reverb is barely flickering. On the other hand, digital distortion is not one of the nicer noises around. Fortunately you can SOLO the FX returns. Here you'll have to rely on your ears to detect digital distortion, since different outboard processors calibrate their meters differently, and their dynamic range is not sufficient to allow, say, 15 dB of headroom (as is the case with DAT etc.). The PFL/SOLO meter, on the other hand, looks only at the desk's analog aux input level, if you hear distortion, but the meter says you're just hitting 0 dB, then it must be coming from the aux send amp or the FX unit. If PFL on the aux send reveals nothing amiss, turn down the input on the FX unit, and turn up the desk's aux return.

- ☞ **99 times out of 100 distortion in the aux send > FX > aux return loop will come from the FX unit (FX GAIN TOO HIGH), and the same goes for a high noise level (FX GAIN TOO LOW).**
- ☞ **Noisy FX (or synth) returns can be greatly improved by the addition of single-ended noise reduction between FX output and aux (or channel) returns. The BEHRINGER DENOISERS are ideally suited for this purpose.**
- ☞ **We found out that using analog single ended noise reduction can help warm the sound of certain digital reverbs which sound too cold/metallic, and also give that “Echoplex” sound to digital delay decays.**
- ☞ **Analog multitrack tape should be driven quite hard, since its dynamic range (without noise reduction) is likely to be 20 to 30 dB worse than other elements in the recording chain. Try to record bright. You can always mix back duller. Brightening up an off-tape signal will bring up the level of tape noise.**
- ☞ **When mixing or recording, keep the channel FADER levels around or below 0 dB. If you do find the faders creeping up or down, apply a suitable offset over all channel faders, and try to control your bad habit in future!**

11. IMPEDANCES AND TUNING

Electronic inputs tend to have impedances measured in tens of kiloOhms. Outputs, on the other hand, are generally two or three orders of magnitude less. This is just as well, otherwise a signal at an output might find that the line of least resistance is the limit of the preceding unit.

In the patchbay section I recommended that you parallel the MAIN MIX output of the EURODESK MX9000 into all 2-track recording inputs. It would not do any harm to buffer each output from the primary one (i.e. that feeding into your most expensive DAT recorder or 1/2" mastering machine) with a 470 Ohm resistor. Cassette, DAT and reel to reel recorders' input impedances should be similar, but just in case they aren't, it is better to add a fraction of a dB of thermal noise to the inputs of the secondary recorders in the shape of a resistor, rather than having an unusually low impedance input grabbing most of the signal. Another neat idea is to parallel the Monitor L/R output via a 47 kOhm resistor pair. Now you can safely connect e.g. a tuner to either extra hole, without shifting the stereo image (this would happen if a low impedance tuner input was connected directly across one side of the monitor output). Now, whenever you monitor an instrument's input level with the PFL/SOLO function, you can check it's tuning also. That should impress the customers. Especially those using old, unstable, but very desirable analog synths.

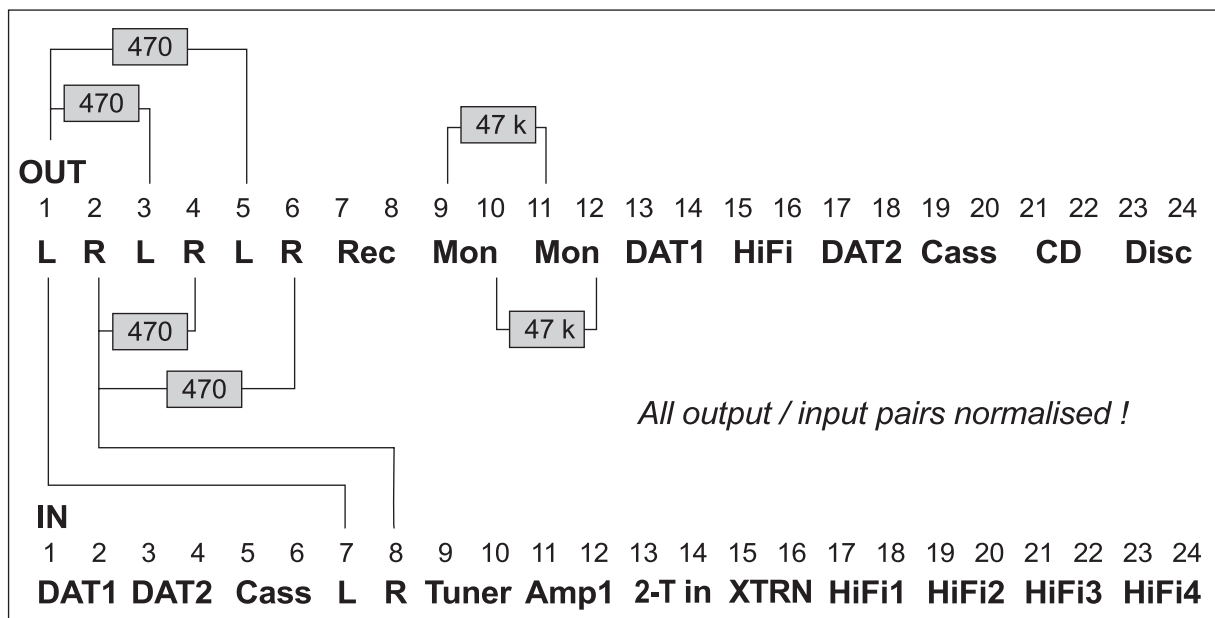

Fig. 11.1: Resistor-buffered parallel wiring for bay 8 (see section 8 "The patchfield")

12. (UN)BALANCED LINES

Balanced inputs and outputs are offered on most audio connections on the EURODESK MX9000 (inserts and direct outs being the major exceptions).

Why? Though all audio cables (except speaker cables) have earthed screens, the shielding they afford from the electromagnetic garbage that permeates the atmosphere is never perfect. The balanced line is a simple but effective mechanism to overcome this problem. Instead of one insulated audio conductor, two, usually twisted together, are contained within a single screen. One conductor, wired to pin 2 of an XLR-type connector by international convention (after decades of total confusion!) carries a signal variously referred to as "hot" or "positive". Pin 3 is wired to the "cold" or "negative" conductor.

What does this mean? Consider an unbalanced line. Now, that's much easier to understand. You have one "hot" or "positive" core, and an earthed screen. The "hot" wire's waveform, if looked at on an oscilloscope, would be directly correlated to the audio signal waveform. If you looked closely at the trace, you'd see random noise along the X axis. What you probably wouldn't see, however, is any superposition of 50, 100 Hz, etc. corresponding to mains hum interference, since these frequencies would be tangled up in the audio signal (to spot them visually you'd need to perform a FOURIER TRANSFORM). AC mains frequency and its overtones are picked up by any wire, and some will always leak through a cable screen. The question is, when does it become audible?

Well, all other things being equal, the amount of mains hum picked up by a cable is independent of the signal level. Speaker lines run 50 or more volts, enough to diminish the effect of mains radiation to vanishingly small even with no screen. (In fact, at these voltages another effect comes into play: capacitive resistance. It is positively undesirable to use screened cable to wire an amp to a speaker. Speaker leads should be as thick and short as possible, with XLR or wound post terminals.) Line-level signals can usually be run unbalanced over short or moderate distances (rack to desk etc.), but NOT from the back of the hall to the stage, always provided that there are no earth loops (see section 8.3 "Looming Problems" A loop acts as an ariel, positively inviting electromagnetic radiation to flow around the system). Microphone lines, however, are another story altogether.

Most microphones generate not volts, but millivolts. Protecting such a low level signal requires a more sophisticated solution. Hence, all mic networks run along balanced lines. It works like this. The mic diaphragm moves forwards and backwards according to the air pressure increases and decreases that constitute sound waves. Diaphragm movement generates a corresponding electrical signal, which is either positive or negative depending on the direction of travel. The +ve and -ve signals are mirror images of each other: if you shorted + and - you'd end up with nothing: one would cancel out the other. In fact this cancelling effect is what makes the balanced line work. Instead of simply shorting the negative line to earth, as would be the case in an unbalanced system (losing half the signal, or 6 dB, in the process), the two lines are kept apart until they reach an electronic (or transformer) balanced input.

Here something exquisitely simple happens:

You may not know this, but whenever a signal is amplified, its polarity is reversed. By inverting the negative side and adding it 1:1 to an unchanged positive, a balanced input wastes none of the available signal energy. In doing so, it also subtracts all the radiation picked up along the line. Random noise is unaffected, but you'll hear no hum, and much reduced thyristor noise (from poorly-screened lighting dimmers). Live, you could not run a rig without balanced mic lines, and although in the studio cable runs are shorter, the recorded medium's demand on signal to noise is far greater.

When patching a balanced input/output to an unbalanced one, simply short the -ve and screen together at the unbalanced input or output.

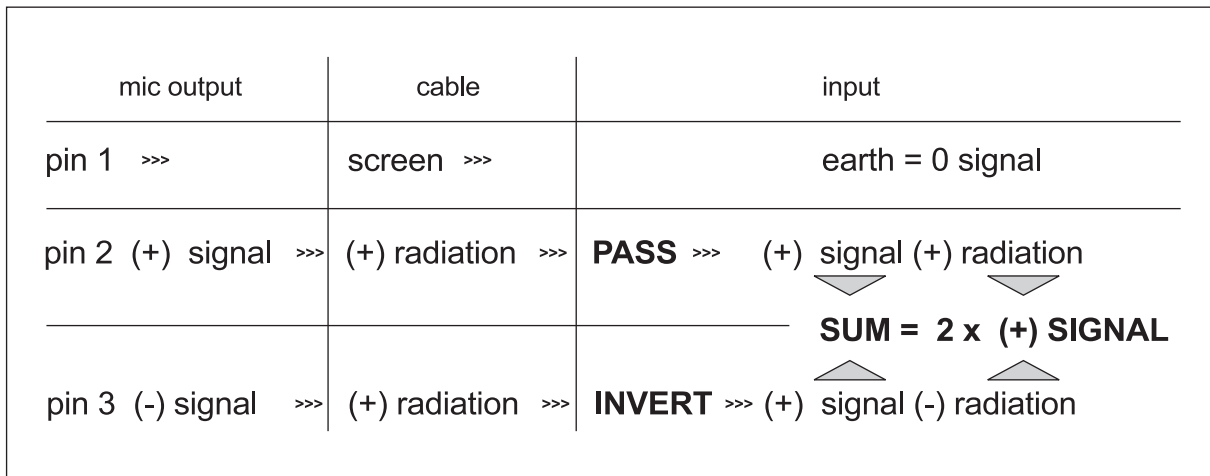

Fig. 12.1: A balanced microphone line

13. START-UP

13.1 A-channel setting up procedure

13.1.1 Selecting inputs

MICROPHONE:	MIC/LINE switch (S1) UP, PAD switch (S1a) UP,	FLIP switch (S3) UP
LINE:	MIC/LINE switch DOWN,	FLIP switch UP
TAPE:		FLIP switch DOWN

13.1.2 Initializing channel for gain-setting

- 1) Set GAIN (P2) and all aux sends (P12, 13, 14 and 15) to OFF (fully counterclockwise).
- 2) EQ switch (S10) UP (off).
- 3) LOW CUT switch (S11) ON for microphones, OFF for signals with desired low frequency content.
- 4) CHANNEL MODE set to PFL (S95 UP).
- 5) Channel PFL/SOLO (S26) switch UP (L26 off).
- 6) Check that main PFL/SOLO LED (L95) is not lit.
- 7) Channel PFL/SOLO switch (S26) DOWN (L26 and L95 should light).

13.1.3 Auditioning a signal

- 1) Make a typical noise, or roll the tape. The -20 dB light should flicker, showing that a signal is present. There should also be some activity at the MAIN MIX bargraph meters, indicating the SOLOed level.
- 2) For LINE INPUTS: Adjust GAIN control (P2) until transient peaks are regularly hitting 0 dB.
- 3) For MIC INPUTS: If your meters are reading 0 dB although the GAIN control is completely turned counterclockwise, push the PAD switch (S1a) to lower the input signal by 20 dB before you continue the gain adjustment.
- 4) TAPE inputs do not pass through the GAIN pot (P2). This is why it is important to match the operating level of the desk (-10 dBV or +4 dBu) to that of your machine. If the signal is low (due to incorrect operating level setting or too low a level having been recorded to tape), try the -10 dBV setting. If too high, try +4 dBu. If neither gives a good level, try patching the tape track output into a line input and repeat steps 13.1.1 and 13.1.2.
- 5) If EQ is used, repeat steps 13.1.1 & 13.1.2.
- 6) If an insert is used to patch in a compressor, gate, EQ, etc., use any outboard processor's BYPASS or EFFECT OFF switch to A/B monitor the effect. Adjust the processor's output level so that effected and bypassed signals are level matched.
- 7) Channel PFL/SOLO switch (S26) UP. Move onto next channel.

13.2 Desk/tape setting up procedures

13.2.1 Desk normalization

All board settings should be set to the normal default condition before or after every session. Usually faders are set to zero (minus infinity), EQs set flat and switched out, trimpots and channel aux sends turned fully anticlockwise etc. The natural initial setting for some pots, e.g. master aux sends, is unity gain. However, some settings, such as selecting PRE or POST for channel aux sends and whether TAPE or MIC/LINE is flipped onto B-channel etc. will depend on the operating environment, whether in a MIDI or A/V suite, 24-track studio or live venue, or even just on the engineer's preferred way of working. Ultimately, the object of the exercise is:

13.2.2 Multitrack initialization

Set up the multitrack so that any track in "record ready" condition has its input monitored when the tape is stationary. Place all tracks to be recorded into "record ready" status (once a recording has been made, these tracks should automatically switch to tape playback). Check that the input levels to each TRACK are optimized before recording commences.

13.2.3 Recording levels

When recording to digital, it's a good idea to keep the recorder's PEAK READING meters below 0 dB. Engage "peak hold" on your recorder if you want to confirm that you haven't inadvertently overstepped the mark during a take or mix. Most digital recorders (though not SAMPLERS) read 0 dB with some headroom left. This is because, unlike with analog, the onset of digital distortion is as sudden as it is horrible, and the manufacturers

of digital recorders don't want you to hear this! If you really want to take your recording level to the limit (and fully exploit digital's 96 dB dynamic range), you'll have some calibrating to do. You could run a tone at 0 dB from the mixer, and use that as your DAT or digital multitrack recorder reference. But your DAT or digital multitrack recorder may still be 10 to 20 dB off its headroom limit. Probably a better way to work out just how hard you can drive your recorder is to incrementally increase the record level until it well distorts, subtract, say 6 dB, and never ever exceed that level.

When recording to analog, the tape machine's VU meters should show around +3dB on BASS, but only around -10 dB for HI HAT. Although analog distortion is more like compression at modest overload levels (often desirable on bottom end), higher frequencies cause saturation even at modest levels (an unpleasant "crunchiness"). Also, VU meters tend to progressively under-read above 1 kHz, due to their sluggish response time.

13.2.4 Auditioning a mix

In order to be heard other than when PFL/SOLO-ed, channels must be routed to the main mix bus. This can be either from the channel routing matrix directly, via one of the subgroups, or from the MIX-B bus (S48 DOWN).

Channels going to tape are usually monitored via the tape return channel, whether A or B. In this case the main mix button of the channel going to tape should be UP, while that coming back should be DOWN (if on an A-channel). Tape tracks returning on B-channels will always be heard so long as the MIX-B/MAIN MIX switch (S48) is depressed.

Some to-tape channels will have no routing other than a direct out patch into the recorder, others may be routed through subgroups. When a subgroup is sending to tape, the subgroup L/R assignment buttons (S37, 38) should be UP. I.e. that subgroup should not feed into the main mix bus directly.

13.2.5 Mixer mapping

When laying out channels for recording or mixing, try to be sensible. Keep tom-toms together, etc. Work out a scheme that suits you and stick to it, e.g. I always started with kick drum, snare, hi-hat, tom-toms (as the audience sees them), cymbals (ditto), bass, guitars, keyboards, other instruments, vocals. From session to session I knew what was where without hardly ever having to look at a tracksheet.

14. 8-TRACK MIDI SUITE/DANCE PRODUCTION STUDIO

8-track MIDI studio with sampler, 8-track recording system, one vocal microphone and an array of synthesizers and FX. MIDI sequencer driven. A typical dance production suite.

14.1 Sends

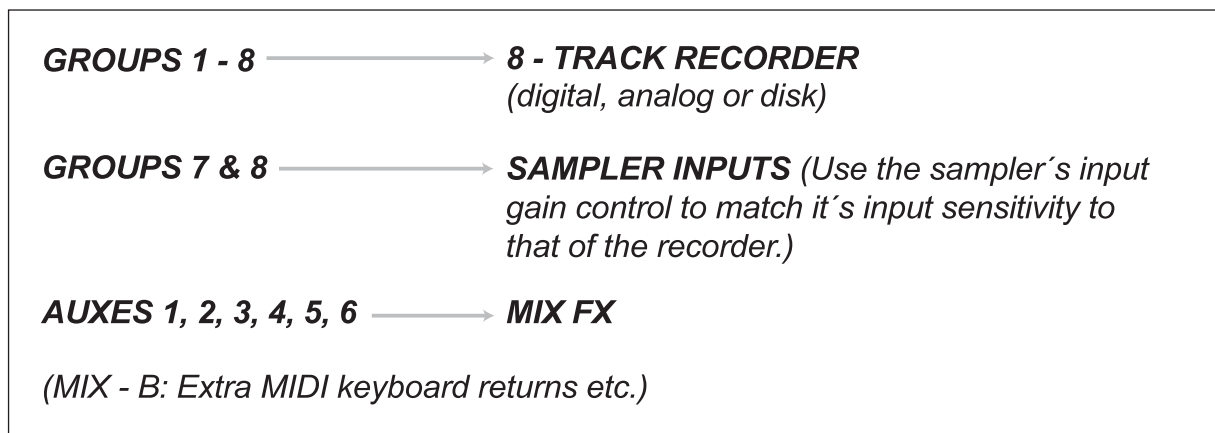

Fig. 14.1: Send routing

In a dance production, effects are often of paramount importance in creating interesting/evolving sounds, and aux sends are usually all dedicated to this purpose. Also, it is not unusual for a vocalist to be drafted in to add some colour to the mix at a late stage. The following set-ups avoid using aux sends for headphone monitoring, while enabling both the vocalist and engineer to get a comfortable headphone mix.

14.2 Auxless headphones mix

The vocalist will probably want to hear her-/himself above the normal mix level. With the following headphone sources you can do this without tying up any aux sends or MIX-B. Passing the DIRECT OUT through any 1 in 2 out delay/reverb device enables the vocalist to choose an effect she/he is comfortable singing along with.

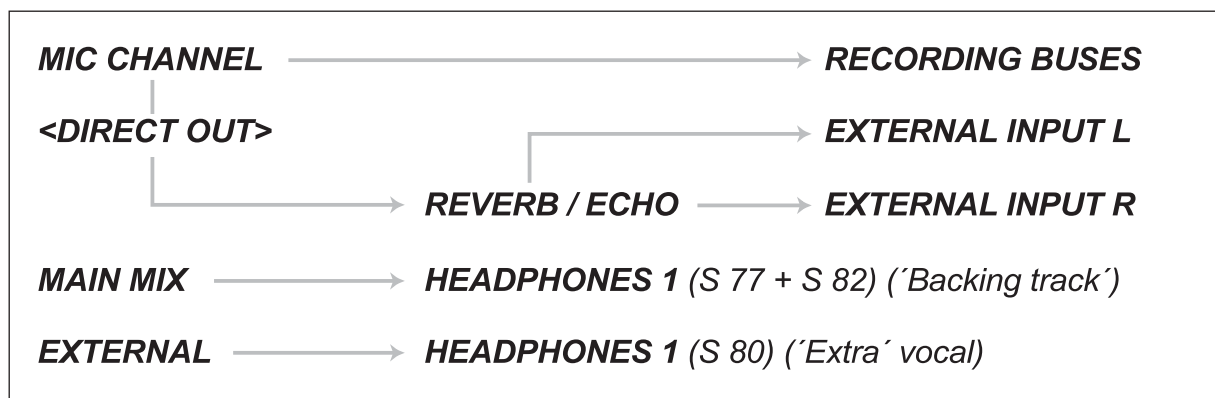

Fig. 14.2: Simple auxless headphones mix

Here the MIC CHANNEL FADER controls the amount of extra voice blended into the main mix. Adjust the FADER level first until the vocalist is happy, then set the level to tape with the SUBGROUP FADER(S).

Alternatively:

Split the microphone onto two channels and use one to feed the routing matrix while the other drives the EXTERNAL input via its direct out. Now you have totally independent monitoring and tape send levels for the vocal signal.

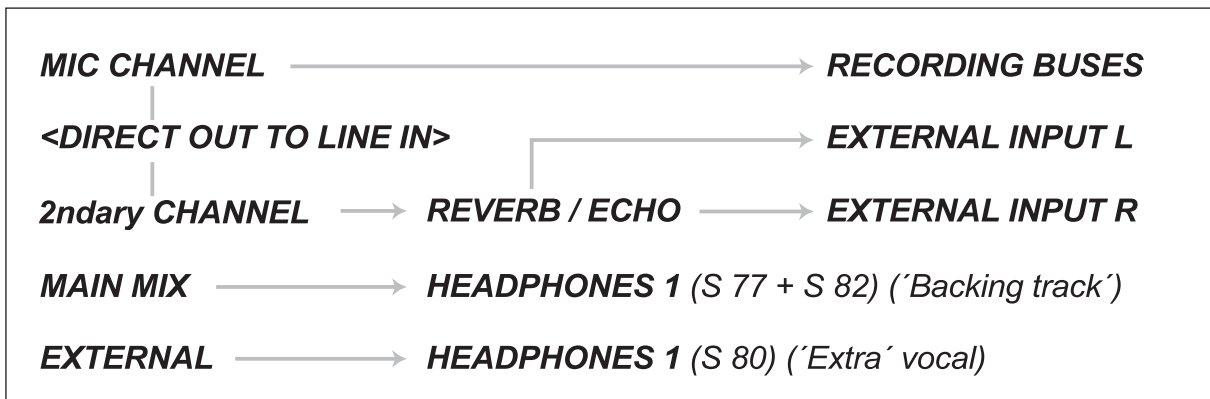

Fig. 14.3: Slightly more complicated auxless headphones mix

Alternatively:

If you need to hear the harmonies, but they're putting the vocalist off key, you'll want to be able to delete channels from the headphone mix. If you still don't want to assign a couple of aux buses to headphones monitoring because this would disturb the main mix, the following suggestion might prove useful. Set up a separate channel assignment on a spare subgroup pair. Feed the output into aux return 3. Route aux return 3 to headphones 1 (S 55) and de-assign the main mix (S77). Now you can delete distracting channels from the vocalist's backing track mix (see fig. 14.4).

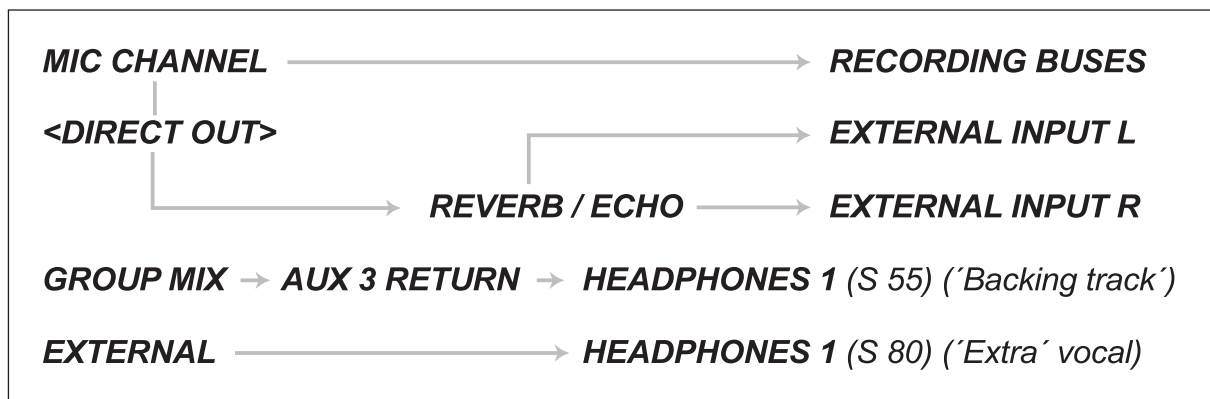

Fig. 14.4: Subgroup-driven auxless headphones mix

This configuration does not allow for anything coming in on B-channels to be sent to headphones. If you need to do this, S76 must also be depressed.

☞ In all cases the WET/DRY balance of the extra vocal signal takes place within the FX processor.

☞ The above example refers to aux 3 return > headphones 1. An analogous situation is possible for aux 4/5/6 return > headphones 1 or 2.

14.3 Returns

Channels 1 to 8: When you've only got eight tape returns, you can afford to bring them back on main channels to enable e.g. chorus vocal comps. or recorded real-time mixing effects such as frequency sweeping to be quickly bounced or sampled off via subgroups.

Channels 9 to 23: The most important SYNTH/SAMPLER outputs. Those most likely to need full EQ or to be recorded to tape. You might have one Minimoog, but half-a-dozen uses for it. Put it on an A-channel. You'll want to record and/or sample it in action.

Channel 24 is of course the MIC input. A compressor might be patched into the channel 24 insert. Keep this channel free until the mix absolutely demands its services, just in case you want to add in any last minute singing, or any last minute anything!

The B-channel line inputs (tape returns) can accommodate even more MIDI expanders and synths, etc.

14.4 Lining up record/sample inputs

Set the relevant TAPE OUTPUT and INPUT switches (located at the rear of the console) to match the operating level of your 8-track (consult manual, “phone manufacturer”, or simply “suck & see” to find which setting works best). The sampler’s variable input gain range should be more than wide enough to accept either -10 dBV or +4 dBu. There is no oscillator in the EURODESK MX9000, but you can use a simple unmodulated sustained tone from a keyboard. Choose one around 1 kHz (B above middle C is 997 or 1002 Hz depending on whether you are using the tempered scale or “just” tuning: either way it’s close enough for jazz). Set the channel EQ to OFF, and line up the channel according to the “Setting up procedure” (section 13.1). Route this signal to all subgroups and adjust the SUBGROUP OUTPUT FADERS until the bargraph meters read 0 dB. Now put the recorder into INPUT mode on all channels, and the sampler into SAMPLE mode. If the tape operating level switches are correctly set, then 0 dB on the subgroup output meters should also show 0 dB on the tape recorder’s input meters. A discrepancy of +/-14 dB indicates a wrong operating level selection. Small discrepancies may be taken up by the SUBGROUP FADERS, though a better solution would be to get the multitrack, properly aligned. (Refer to multitrack manual and/or qualified personnel.) Adjust the sampler’s input level until it also reads 0 dB.

 **Beware of inaccurate/uncalibrated sampler input meters. Work out how hard you can safely drive the sampler’s input, reference this to 0 dB on a EURODESK subgroup meter, then take note of the sampler’s input gain pot setting. (Or use soft adhesive tape etc. to hold it in one position.)**

(For more info on digital metering and associated problems see section 13.2.3.)

14.5 Mixdown

The situation here is no different from record, really, save that the subgroups may now be routed directly to the main mix (L/R) bus (S35 to 38) for easier mixing. Remember, you started off with the tape returns coming up on A-channels 1 to 8, therefore there is no need to “flip” them. You will probably (definitely) be running lots of MIDI sequencer tracks live. Take care not to encourage MIDI delays (see section 22 “SEQUENCING LIVE”).

15. 16-TRACK RECORDING WITH 2 SAMPLERS

15.1 Recording

Subgroup outputs/tape sends 1 to 16 should be wired to the multitrack record inputs 1 to 16. Sampler inputs should be connected to subgroup outs 5, 6, 7 and 8 via custom-made Y-adaptors. Lining up is as per the previous example (see section 14.3). When choosing which outputs where to assign, you have to consider that you have got maybe 16 tape and 16 or 20 sampler outputs to accommodate onto 24 A-channels (and 24 B-channels)! We’d suggest all audio tape tracks be returned on A-Channels, while at least one stereo output from a sampler is also brought back on a pair of A-channels for “flying in” (a sampler can pick up e.g. chorus vocal and drop it into all choruses, or sample a particularly nifty bit of flanging on a drum loop etc.; then lay the effected loop back to tape, without re-patching). Most other sampler outputs and MIDI keyboards which need to be heard but not recorded can be assigned to B-channels. The remaining six or so A-channels may then be used for overdubs.

15.2 Headphones

While auxless headphone monitoring (see section 14.2) is still an option (and a pretty good one), a small general purpose studio might require a more straightforward way of working using one or two discrete headphone mixes. Here, it would be best to keep aux sends 1 and 2 free for monitoring purposes until mixdown time.

Aux returns 3/4/5/6 can be routed directly to headphones 1 and/or 2. A good idea would be to drive HP1 from a combination of aux return 3 (S55) and MIX-B (S76), while HP2 picked up its signal from aux return 4 (S69) and MIX-B (S88). Channel auxes 3 and 4 would be routed to A-channels. In this configuration a reasonable degree of balancing between the MIX-B and aux 3/4 level into the cans is possible by adjusting P55/68 (minus infinity to +15 dB).

 **With the headphone configuration shown below, there is no easy way to get FX returns into the cans. Bring these back on A or B channels instead, until mixdown time.**

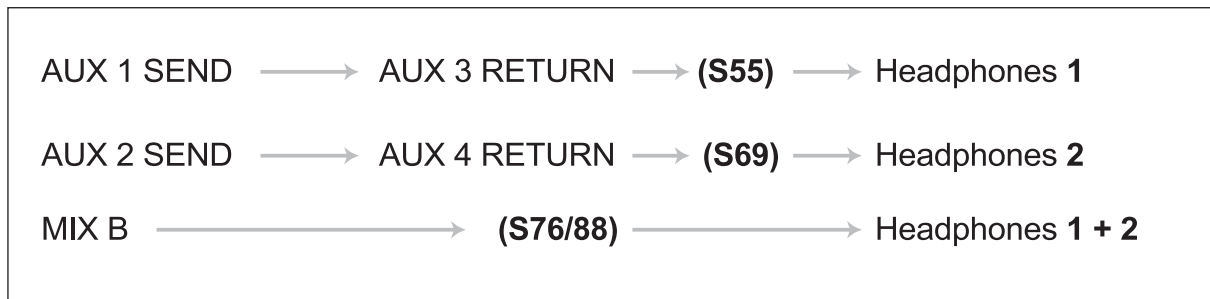

Fig. 15.1: Headphones

15.3 Mixdown

With 24 A-channels and up to 36 significant tape and sampler tracks to accommodate, some thought will need to be given to mixdown assignments. Tracks which need little EQ and no access to the main track reverbs/echoes on auxes 1 and 2 may be parked on B-channels. Lead tracks and prominent rhythm/melodic voices should be placed onto A-channels. Remember that auxes 3/4/5/6 can be dedicated either to A or B-channels by SOURCE switch S17.

16. PROFESSIONAL 24-TRACK STUDIO

16.1 Recording

Chances are you'll occasionally want to record more than eight tracks at once, e.g. you're recording a band playing together live. The following example covers a rock band with drums, bass, two guitars, percussionist, brass section, lead and backing vocals. In the real world, you'll hardly ever be taking all these artists at once, but if you are:

Channels	Source	Route	Destination
1	Kick	Direct out	Track 2
2	Snare	Direct out	Track 3
3	Hi Hat	Direct out	Track 4
4	Tom 1	Subgroups 5 and 6	Tracks 5 and 6
5	Tom 2	Subgroups 5 and 6	Tracks 5 and 6
6	Tom 3	Subgroups 5 and 6	Tracks 5 and 6
7	Tom 4	Subgroups 5 and 6	Tracks 5 and 6
8	Cymbals (overheads) L	Direct out	Track 7
9	Cymbals (overheads) R	Direct out	Track 8
10	Bass microphone	Subgroup 3	Track 1
11	Bass DI	Subgroup 3	Track 1
12	Escaping prisoners	Subgroup 4	Who knows?
13	Trumpet	Subgroups 1 and 2	Tracks 9 and 10
14	Trombone	Subgroups 1 and 2	Tracks 9 and 10
15	Sax	Subgroups 1 and 2	Tracks 9 and 10
16	BVs 1	Subgroups 7 and 8	Tracks 11 and 12
17	BVs 2	Subgroups 7 and 8	Tracks 11 and 12
18	BVs 3	Subgroups 7 and 8	Tracks 11 and 12
19	Conga L	Direct out	Track 13
20	Conga R	Direct out	Track 14
21	Guitar 1 microphone	Direct out	Track 15
22	Guitar 2 microphone	Direct out	Track 16
23	Lead vocal	Direct out	Track 17

Tab. 16.1: Channel assignment

Tape Monitoring will be via MIX-B in tape return mode. Once tracks are layed, they will be flipped onto the A-channels (1 to 17), and overdubbing can commence via tracks 18 to 24. Also “bouncing”, reducing several tracks onto one or a stereo pair, requires access to the full routing matrix. This is available to the A-channels, but not the B-channels.

16.2 Very tricky headphones

In a multi-musician scenario you'll probably want as many different headphones mixes as you can muster. With the current channel/group/track assignments it is possible to set up four independent, or semi-independent, headphone feeds while still keeping back auxes 3/4/5/6 for "wet" monitoring (see 16.3).

Subgroup 7 => aux return 3 => headphones 1	Subgroup 8 => aux return 4 => headphones 2
Main mix (and)/or MIX-B => headphones 1	Main mix (and)/or MIX-B => headphones 2
Active switches: S55/(S82, S77)/S76	Active switches: S69/(S82, S89)/S88

See also fig. 14.4 "Subgroup driven auxless headphones mix" and associated text.

In the above configuration HP1 and HP2 comprise a blend of the main mix, MIX-B and an additional feed from a subgroup. The subgroup feed can be used to select which channel(s) should be boosted in the cans relative to the main mixes.

 **Choose to send to subgroups 7 and 8 from channels which are routed to tape from their DIRECT OUT. Otherwise CHANNEL PAN, which will already have been set for recording via another group, is unlikely to be pointing to where you want the cue signal to go. Aux sends 1 and 2 are available as two separate mono headphone feeds, or as a single stereo headphone feed. You'll need an extra stereo amplifier to amplify the aux 1 and 2 outputs to drive headphones properly.**

Overdubbing:

It's all change. Flip the recorded music onto A-channels, in order to feed from tape into all the headphones buses.

Alternatively:

(and probably much more sensibly): use the headphones routine outlined in section 15.2 (fig. 15.1).

16.3 Wet monitoring

It is customary with live recording to lay tracks dry. (Not so with MIDI setups: often a tape track is used to record a complex effect. In a MIDI studio a take is generally MIDI sequencer driven, and hence reproducible should the recorded effected track eventually prove to be unsuitable, in live recording, a great take is irreplaceable! Hence the extra caution when laying live tracks.) With dry recording you will probably want to audition tape tracks with some reverb and/or echo, to get a better idea of how the final mix might sound. By pressing the AUX 3/4/5/6 SOURCE switch (S17), aux buses 3 and 4 are available to the B-channels, i.e. tape monitoring. You could send to reverb from input channels, but the FX would disappear on tape playback. Bring the FX back on aux returns 1, 2, 5 or 6. Remember 3 and 4 have been used for headphones patching.

16.4 Mixdown

All aux sends and subgroups are now available for mixing, as are A-channels 23 and 24.

 **If you have two different instruments recorded onto one track, the mixdown settings for each might be totally different. Set up two A-channels. One for each instrument, and switch between them.**

The B-channels may be used e.g. as FX returns in place of the normal aux returns (the advantage being that these channels have PAN and EQ) or as an extra stereo aux send.



17. LIVE P.A. WITH 2-TRACK RECORDING

In this example we'll use the aux sends 1 and 2 for stage foldback, and 3/4/5/6 for front-of-house effects. The P.A. is driven from the main mix. MIX-B will be used to set up the mix to DAT.

Channels	Source	FOH	FX	Wedges / monitoring
1	Kick	Subgroups 1 and 2 / MIX-B	-	Aux send 1 and 2
2	Snare	Subgroups 1 and 2 / MIX-B	Aux send 4	Aux send 1 and 2
3	Hi Hat	Subgroups 1 and 2 / MIX-B	-	Aux send 1 and 2
4	Tom 1	Subgroups 1 and 2 / MIX-B	Aux send 4	-
5	Tom 2	Subgroups 1 and 2 / MIX-B	Aux send 4	-
6	Tom 3	Subgroups 1 and 2 / MIX-B	Aux send 4	-
7	Tom 4	Subgroups 1 and 2 / MIX-B	Aux send 4	-
8	Cymbals (overheads)	Subgroups 1 and 2 / MIX-B	-	-
9	Keyboards L	Subgroups 3 and 4 / MIX-B	-	Aux send 1 and 2
10	Keyboards R	Subgroups 3 and 4 / MIX-B	-	Aux send 1 and 2
11	Bass DI	Main mix / MIX-B	-	Aux send 1 and 2
12	Trumpet	Subgroups 5 and 6 / MIX-B	Aux send 5	Aux send 2
13	Trombone	Subgroups 5 and 6 / MIX-B	Aux send 5	Aux send 2
14	Sax	Subgroups 5 and 6 / MIX-B	Aux send 5	Aux send 2
15	BVs 1	Subgroups 7 and 8 / MIX-B	Aux send 5 and 6	Aux send 1 and 2
16	BVs 2	Subgroups 7 and 8 / MIX-B	Aux send 5 and 6	Aux send 1 and 2
17	BVs 3	Subgroups 7 and 8 / MIX-B	Aux send 5 and 6	Aux send 1 and 2
18	Conga L	Main mix / MIX-B	-	Aux send 2
19	Conga R	Main mix / MIX-B	-	Aux send 2
20	Guitar 1 microphone	Main mix / MIX-B	-	Aux send 1 and 2
21	Guitar 2 microphone	Main mix / MIX-B	-	Aux send 1 and 2
22	Lead vocal	Main mix / MIX-B	Aux send 5 and 6	Aux send 1 and 2
23	FX 1 L	Main mix / MIX-B	-	-
24	FX 1 R	Main mix / MIX-B	-	-

Tab. 17.1: Channel assignments 2-track

Every B-channel has its own LEVEL, PAN and HIGH and LOW EQ. MIX-B in fact is acting here like a totally independent separate mixer, albeit with fewer facilities than the main mix. The primary stereo reverb/echo unit's outputs have been patched into A-channels rather than an aux return, to enable them to be sent to the MAIN MIX and MIX-B independently.

-  **S48 is UP, i.e. MIX-B is NOT blended into the main mix.**
-  **Bringing the DAT back on aux 1 return P49 (as opposed to the 2-track or external inputs) enables not only auditioning of DAT playback, but also balancing playback level against the main mix, in case you also want to use it to play a pre-recorded intro tape to set the scene for the coming performance.**
-  **Be sure to have aux return 1 turned all the way down or de-assigned when recording to DAT. Otherwise expect massive and terminal (as far as the P.A. and gig are concerned) howlround.**

18. LIVE CONCERT WITH 24-TRACK RECORDING

Stereo (quadraphonic) P.A. with sidefills, three infills, two wedge mixes, four FX and simultaneous 24-track recording.

Channels	Source	Tape route	Destination
1	Kick	Direct out	Track 1
2	Snare	Direct out	Track 2
3	Hi Hat	Direct out	Track 3
4	Tom 1	Subgroups 5 and 6	Tracks 5 and 6
5	Tom 2	Subgroups 5 and 6	Tracks 5 and 6
6	Tom 3	Subgroups 5 and 6	Tracks 5 and 6
7	Tom 4	Subgroups 5 and 6	Tracks 5 and 6
8	Cymbals (overheads)	Direct out	Track 4
9	Keyboards L	Direct out	Track 7
10	Keyboards R	Direct out	Track 8
11	Bass DI	Direct out	Track 9
12	Trumpet	Direct out	Track 10
13	Trombone	Direct out	Track 11
14	Sax	Direct out	Track 12
15	BVs 1	Direct out	Track 13
16	BVs 2	Direct out	Track 14
17	BVs 3	Direct out	Track 15
18	Conga L	Direct out	Track 16
19	Conga R	Direct out	Track 17
20	Guitar 1 microphone	Direct out	Track 18
21	Guitar 2 microphone	Direct out	Track 19
22	Lead vocal	Direct out	Track 20
23	Main echo / reverb return	(Send = aux 3)	Track 21
24	Main echo / reverb return	(Send = aux 3)	Track 22

Tab. 18.1: Channel assignments 24-track (track 24 pre-striped with SMPTE)

None of the tape tracks can be auditioned in this configuration. The channel fader controls the level to tape, MIX-B adjusts the P.A. level.





The channel inserts (which are pre fader), may be used as virtual direct outs. Hopefully you will be able to set the input gains (P2) to suit the multitrack on any channel that does not have a massive EQ (i.e. energy) swing away from 0 dB. The consequent lack of any desk EQ on your tape tracks might even be an advantage when it comes to remixing the concert back in the studio.

Using this setup, you can even change the P.A. to a quadraphonic system. Positioning takes place by balancing the main mix (channel fader, PANpot P24) against MIX-B (P20, P21).

Channels	Source	F.O.H.	FX	Wedges	Infills
1	Kick	MIX-B	-	-	Subgroups 1/2, 3/4 and 7/8
2	Snare	MIX-B	Aux send 4	Aux send 1 and 2	Subgroups 1/2 and 3/4
3	Hi Hat	MIX-B	-	-	Subgroups 1/2 and 3/4
4	Tom 1	MIX-B	Aux send 4	-	-
5	Tom 2	MIX-B	Aux send 4	-	-
6	Tom 3	MIX-B	Aux send 4	-	-
7	Tom 4	MIX-B	Aux send 4	-	-
8	Cymbals (overheads)	MIX-B	-	-	-
9	Keyboards L	MIX-B	-	-	Subgroup 12
10	Keyboards R	MIX-B	-	-	Subgroup 12
11	Bass DI	MIX-B	-	-	Subgroups 1/2, 3/4 and 7/8
12	Trumpet	MIX-B	Aux send 5	-	-
13	Trombone	MIX-B	Aux send 5	-	-
14	Sax	MIX-B	Aux send 5	-	-
15	BVs 1	MIX-B	Aux send 5 and 6	Aux send 1 and 2	-
16	BVs 2	MIX-B	Aux send 5 and 6	Aux send 1 and 2	-
17	BVs 3	MIX-B	Aux send 5 and 6	Aux send 1 and 2	-
18	Conga L	MIX-B	-	-	Subgroups 1/2, 3/4 and 7/8
19	Conga R	MIX-B	-	-	Subgroups 1/2, 3/4 and 7/8
20	Guitar 1 microphone	MIX-B	-	-	Subgroups 3 and 4
21	Guitar 2 microphone	MIX-B	-	-	Subgroups 3 and 4
22	Lead vocal	MIX-B	Aux send 5 and 6	Aux send 1	-
23	FX 1 L	MIX-B	-	Aux send 1	-
24	FX 1 R	MIX-B	-	Aux send 1	-

Tab. 18.2: Front/rear/stage monitors routing

For front of house route all channels to the MIX-B bus > main mix. For live P.A. effects use auxes 3/4/5/6. For wedge monitors use aux 1 and 2 in pre mode > aux 1 and 2 output. For sidefills use phones 1 output. For infill for guitarist, keyboard player and drummer use subgroups 1/2, 3/4 and 7/8.

-  **No subgrouping is used as a mixing aid to the FOH mix.**
-  **Infill sends use up one group pair each as a consequence of the routing matrix being dependent on the channel PANpot (P24).**
-  **All channels should be set for: aux 1/2: PRE (S13 DOWN) > WEDGES; aux 3/4/5/6: POST (S16 UP) > FX; MIX-B SOURCE = CHANNEL (S23 DOWN); FLIP = Mic/Line SIGNAL (S3 UP)**
-  **In a quadrophonic setup MIX-B should be kept separate from the main mix (S48 UP).**

OK: This example has been extreme. Chances are if you were touring with the sort of PA / multitrack described above you'd also have a massive FOH console, separate foldback mixer, and a rider that would make Bill Graham blanche. None of the applications examples are designed to be used as a BLUEPRINT. Rather, they should give you some idea of the scope and flexibility of your EURODESK MX9000. Use your imagination to find novel ways of solving problems and creating extra facilities.

19. EXPANDING THE EURODESK MX9000

19.1 Connections

The EXPANDER PORT is input only, and provides access to all but the PFL/SOLO buses. Since the nominal internal operating level of your EURODESK MX9000 is 0 dB, and that at the jack outputs +4 dB, the sends from the outputs of console 2 must be attenuated by +4 dB if unity gain between it and the primary console is to be maintained. Wiring is as follows:

<u>EURODESK 2</u>	>	-4 dB	>	<u>EURODESK 1</u>
Subgroup outputs 1 to 8	>	-4 dB	>	EXPANDER PORT subgroup inputs 1 to 8
Aux outputs 1 to 6	>	-4 dB	>	EXPANDER PORT aux inputs 1 to 6
Main mix output	>	-4 dB	>	EXPANDER PORT main mix inputs
MIX-B output	>	-4 dB	>	EXPANDER PORT MIX-B input
<u>Another manufacturer's desk</u>	>	-X dB	>	<u>EURODESK 1</u>
Subgroup outputs 1 to 8	>	-X dB	>	EXPANDER PORT subgroup inputs 1 to 8
Aux outputs 1 to 6	>	-X dB	>	EXPANDER PORT aux inputs 1 to 6
Main mix output	>	-X dB	>	EXPANDER PORT main mix inputs
MIX-B output	>	-X dB	>	EXPANDER PORT MIX-B input

19.2 Alignment

To find out the value of "X" align the consoles in the following way. Patch a 1 kHz sine tone (or play a sustained B above middle C on a keyboard) into a channel on each console. Set up each console so that the signal produces unity gain (0 dB) at every output (use each console's PFL or equivalent function to do this). Now, connect the outputs of the second console into the EURODESK EXPANDER PORT. Mute the channel on the EURODESK carrying the signal, and look at the EURODESK outputs. Systematically adjust the reading on each bus until they all read 0 dB by adjusting the master send levels of console 2 (i.e.: master aux send controls, main mix master faders, subgroup faders, etc.).

20. TIMECODE

In analog multitrack recording timecode usually goes down on the edge of the tape: track 8, 16 or 24, with the adjacent track left clear (GUARD BAND) to stop bleeding between recorded tracks and code. Digital formats do not waste any audio tracks on timecode: a separate sync is provided.

Ideally, timecode should be patched from the multitrack out directly into the synchronizer input. Normally, a 24 track tape is striped with timecode before a session commences. Any sequenced music, click track, mix automation is then referenced to it.

Always check sync before laying down any sequenced music: record a click track, then check to see that a "live" playback doesn't drift. Timecode comes in various formats. The general rule is: format (and make/model) of timecode generator must be matched to the reader. This shouldn't be a problem if recording and mixing take place in-house and under one roof. It's when tapes move around that problems arise (be sure to include every conceivable technical detail on a tracksheet accompanying the master tape). Fortunately, there are ways to generate fresh in-sync timecode even where none existed in the first place, otherwise most remixes would never happen. You (and I) would rather not have to, though, since it takes time, effort, and an intelligent "learning" synchronizer to do it.

If the gain from the recorder is too low to drive the sync unit,

- 1) re-stripe at a higher level or
- 2) amplify the recorded timecode somehow, possibly via a desk channel not routed to any of the main buses. In this case use the channel's direct out to drive the synchronizer's input, in order to keep the timecode as remote as possible from the audio (timecode crosses over like nothing else I know).

21. BOUNCING

Sometimes you want to play back from one or more tracks, route the signals to a new track or pair of tracks, and re-record. This process is commonly referred to as bouncing. Examples would be when reducing 4 lead vocal take tracks down to 1, reducing 4 separate tom-tom tracks down to a stereo pair via noise gates, putting a wild effect or EQ onto a dry signal, “comping” backing vocal tracks, etc.

On an analog tape recorder, bouncing to an adjacent track is to be avoided. A feedback loop can be set up, since for all overdubs or bounces you will be using the same (sync) head for both playback and record. Organize your track layout so that any bounces you might have to do are always over at least one track.

There are no restrictions when using digital multitracks.

22. SEQUENCING “LIVE”

“Live” sequencing is a term used when a sequencer is driving MIDI instruments in a mixdown. Many re-mixers do not like to do this for several reasons.

1. It may be a problem re-assembling all the hardware/software used if a re-mix is required once the MIDI equipment has left the studio.
2. It is easier to send 2 x 24 track tapes around the world than a truckload of gear.
3. MIDI timing problems mean that a tape master can sound tighter: MIDI sequencer tracks are laid one at a time, usually in sequencer SOLO mode, to reduce MIDI congestion to a minimum.

However:

Laying on linear tape has its drawbacks. Apart from the sheer cost of hiring a 24/48 track studio, what happens if you want to change a song's structure half-way through?

Non-linear devices are still expensive, and far the cheapest way to keep the arrangement flexible is to employ a sequencer. MIDI is slow, but you can get around this by following these basic rules.

1. TRACK STACK RULE

MIDI sequencer tracks read from the top, therefore put the most timing specific tracks at the top. Start with rhythmic loops, then voices with fast transients like percussion etc.

2. MIDI SPREAD RULE

Spread MIDI data as thinly as possible for fastest response times. There are two ways to do this. First, have as many MIDI ports as your computer will allow, and spread the MIDI activity as evenly as possible among them. Secondly, try to have as few MIDI notes as possible playing simultaneously, e.g. advance slow attack tracks, put little silence onto the front of samples etc.



“Live” sequence mixing is most suitable for enthusiasts who have all their own hardware permanently set up in one location. When a mix has been cracked, the elements can then be laid to multitrack for re-mixing, should the need arise.

23. INPUT/OUTPUT CONFIGURATION



	Nominal level	Balanced	Attenuation
EURODESK internal	+4 dBu	-	-
XLR microphone input	-	Yes	Trimpot / PAD switch
Line A input	+4 dBu	Yes	Trimpot
Line B / tape input	+4 dBu / -10 dBV	Yes	Gain switch
Aux sends	+4 dBu	No	Pot
Aux returns	0 dBu	No	Pot
MIX-B output	+4 dBu	No	Pot
Subgroup output	+4 dBu / -10 dBV	Yes	Gain switch
Main mix 1/4" jack	+4 dBu	No	Fader
Main mix XLR	+4 dBu (max. +28 dBu)	Yes	Fader
2-track out RCA	+4 dBu	No	Fader
2-track in 1/4" jack / RCA	+4 dBu	No	No
External input	+4 dBu	No	No
Channel insert out	+4 dBu	No	No
Channel insert in	+4 dBu	No	No
Channel direct out	+4 dBu	No	Fader
Subgroup insert out	0 dBu	No	No
Subgroup insert in	0 dBu	No	No
Main mix insert out	0 dBu	No	No
Main mix insert in	0 dBu	No	No
Control room out	+4 dBu	No	Pot
Studio out	+4 dBu	No	Pot
Meter / analyzer out	+4 dBu	No	No

Fig. 23.1: Input/output configuration

The EXPANDER PORT inputs have a nominal level of -2 dBu (subgroup/mix) and +2 dBu (aux).

-  **All variable gain circuits offer +15 dB (except aux returns, which offer +20 dB).**
-  **All balanced jack sockets are automatically unbalanced when using an unbalanced jack patch lead!**

24. MODIFICATIONS

-  **These modifications require you to do some soldering. Attempt only if you are experienced in using an iron on PCBs. Otherwise, refer to qualified personnel. After modification the warranty becomes discretionary.**
-  **Excuse us for repeating ourselves once again: BEHRINGER is not responsible for anything what happens after you start disassembling your EURODESK MX9000. Don't even think of it, if you make much of your warranty privileges.**
-  **Links should not be threaded into holes on the PCB. They should be soldered to the tinned areas around the holes, and bowed slightly upwards in between.**

24.1 Aux sends > post EQ

All channel aux sends are post mute and pre fader. If you want to convert these to post EQ, carry out the following modification to each channel. You will find a corresponding printing on the PCB (see fig. 24.1).

1. Disconnect power supply.
2. Cut the “post mute” track.
3. Add in a “post EQ” link.
4. Repeat for all channels you want to be modified.

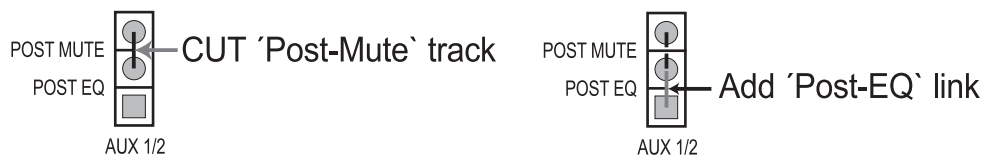

Fig. 24.1: Modifications aux send > post EQ

24.2 MIX-B source > post fader

That's it. You've decided to use the MIX-B as a stereo aux send to FX rather than a separate stereo feed. You can move the tap from the A-channel from pre to post the channel fader as follows. Again, look for the printing on the PCB shown below.

1. Disconnect power supply.
2. Cut the “pre” track.
3. Add in a “post” link.
4. Repeat for all channels you want to be modified.

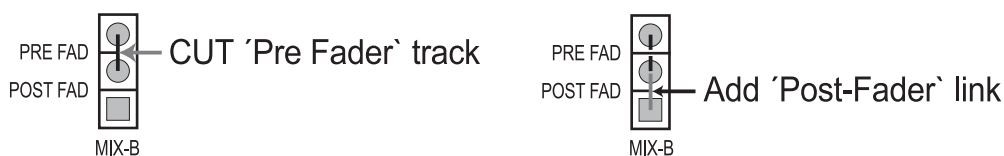

Fig. 24.2: Modifications MIX-B source > post fader

24.3 LED meters > pre fader

In channel mode the meterbridge monitors the DIRECT OUT signal (post EQ, post mute and post fader). You would prefer to see what's going on pre mute and pre fader? Once you found the corresponding printing on the PCB, all you have do is:

1. Disconnect power supply.
2. Cut the “line out” track.
3. Add in a “pre fade” link.
4. Repeat for all channels you want to be modified.

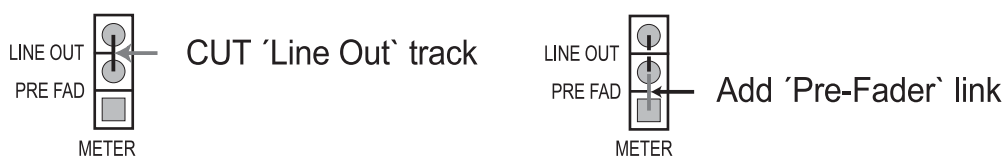

Fig. 24.3: Modifications LED meters > pre fader

25. SPECIFICATIONS

Main channel strip

Mic input	electronically balanced, discrete input configuration
Mic E.I.N. (22 Hz to 22 kHz)	-129.0 dBu, 150 Ohms source -117.3 dBqp, 150 Ohms source -132.0 dBu, input shorted -122.0 dBqp, input shorted
Distortion (THD & N)	0.007 % at +4 dBu, 1 kHz, bandwidth 80 kHz
Gain range	+10 dB to +50 dB
Max. input	+12 dBu (+32 dBu @ PAD)
Line input	electronically balanced
Gain range	unity to +40 dB (-20 to +20 dB @PAD)
Max. input	+22 dBu
Channel fader range	+10 dB to -85 dB / off
Aux send gain range	off to unity to +15 dB

Equalization

Hi shelving	12 kHz, +/- 15 dB
Hi mid sweep	300 Hz to 20 kHz, +/- 15 dB
Lo mid sweep	50 Hz to 3 kHz, +/- 15 dB
Lo shelving	80 Hz, +/- 15 dB
Lo cut (HPF)	75 Hz, 12 dB/oct.

Channel direct out

Max. output	+ 22 dBu
Noise @unity gain	-94 dBu
Output impedance	120 Ohms
Tape returns	bal./unbal. 1/4" jacks, globally switchable from +4 dBu to -10 dBV

Channel insert

Max. in/out	+22 dBu
Channel to channel crosstalk	-95 dB @ 1 kHz

Mix B channel strip

Gain range	off to unity to +15 dB
Hi shelving	12 kHz, +/- 15 dB
Lo shelving	80 Hz, +/- 15 dB

Subgroup section

Noise	bus noise @ fader 0 dB: -102.5 dBr (ref. +4 dBu) -92.5 dBr (ref. +4 dBu, 24 chs. assigned (input B) & set @ unity gain) -94.5 dBr (ref. +4 dBu, 16 chs. assigned (input B) & set @ unity gain)
Submaster output max. out	+22 dBu balanced/unbalanced
Submaster insert max. out	+22 dBu
Submaster insert max. in	+22 dBu
Fader range	+10 dB to -85 dB / off

Main mix section

Noise	bus noise @ fader 0 dB: -101.0 dBr (ref. +4 dBu) -92.5 dBr (ref. +4 dBu, 24 chs. assigned (input B) & set @ unity gain) -94.5 dBr (ref. +4 dBu, 16 chs. assigned (input B) & set @ unity gain)
Max. output	+28 dBu balanced XLR, +22 dBu unbalanced 1/4" jacks

Aux returns gain range	off to unity to + 20 dB
Aux sends max. out	+22 dBu
General	
Distortion (THD & N)	0.007 %, @ +4 dBu, 1 kHz, bandwidth 80 kHz below 0.02 %, 22 Hz to 22 kHz at normal operating levels, any input to any output, bandwidth 80 kHz
Frequency response	20 Hz to 40 kHz, +/- 1 dB any input to any output 10 Hz to 120 kHz, +/- 3 dB -102.5 dBr (ref. +4 dBu) -92.5 dBr (ref. +4 dBu, 24 chs. assigned (input B) & set @ unity gain) -94.5 dBr (ref. +4 dBu, 16 chs. assigned (input B) & set @ unity gain)
Power supply	
External power supply	400 Watts, 19" (482.6 mm), 2.5 rack units, approx. 7 kg
Dimensions/weight	
Dimensions (H * W * D)	approx. 3.54/9.45" (90/240 mm) * 37" (940 mm) * 29.5" (750 mm)
Weight	approx. 30 kg (without PSU)

BEHRINGER is constantly striving to maintain the highest professional standards. As a result of these efforts, modifications may be made from time to time to existing products without prior notice. Specifications and appearance may differ from those listed or illustrated.

26. WARRANTY

§ 1 WARRANTY CARD/ONLINE REGISTRATION

To be protected by the extended warranty, the buyer must complete and return the enclosed warranty card within 14 days of the date of purchase to BEHRINGER Spezielle Studiotechnik GmbH, in accordance with the conditions stipulated in § 3. Failure to return the card in due time (date as per postmark) will void any extended warranty claims.

Based on the conditions herein, the buyer may also choose to use the online registration option via the Internet (www.behringer.com or www.behringer.de).

§ 2 WARRANTY

1. BEHRINGER (BEHRINGER Spezielle Studiotechnik GmbH including all BEHRINGER subsidiaries listed on the enclosed page, except BEHRINGER Japan) warrants the mechanical and electronic components of this product to be free of defects in material and workmanship for a period of one (1) year from the original date of purchase, in accordance with the warranty regulations described below. If the product shows any defects within the specified warranty period that are not due to normal wear and tear and/or improper handling by the user, BEHRINGER shall, at its sole discretion, either repair or replace the product.

2. If the warranty claim proves to be justified, the product will be returned to the user freight prepaid.

3. Warranty claims other than those indicated above are expressly excluded.

§ 3 RETURN AUTHORIZATION NUMBER

1. To obtain warranty service, the buyer (or his authorized dealer) must call BEHRINGER (see enclosed list) during normal business hours **BEFORE** returning the product. All inquiries must be accompanied by a description of the problem. BEHRINGER will then issue a return authorization number.

2. Subsequently, the product must be returned in its original shipping carton, together with the return authorization number to the address indicated by BEHRINGER.

3. Shipments without freight prepaid will not be accepted.

§ 4 WARRANTY REGULATIONS

1. Warranty services will be furnished only if the product is accompanied by a copy of the original retail dealer's invoice. Any product deemed eligible for repair or replacement by BEHRINGER under the terms of this warranty will be repaired or replaced within 30 days of receipt of the product at BEHRINGER.

2. If the product needs to be modified or adapted in order to comply with applicable technical or safety standards on a national or local level, in any country which is not the country for which the product was originally developed and manufactured, this modification/adaptation shall not be considered a defect in materials or workmanship. The warranty does not cover any such modification/adaptation, irrespective of whether it was carried out properly or not. Under the terms of this warranty, BEHRINGER shall not be held responsible for any cost resulting from such a modification/adaptation.

3. Free inspections and maintenance/repair work are expressly excluded from this warranty, in particular, if caused by improper handling of the product by the user.

This also applies to defects caused by normal wear and tear, in particular, of faders, potentiometers, keys/buttons and similar parts.

4. Damages/defects caused by the following conditions are not covered by this warranty:

▲ misuse, neglect or failure to operate the unit in compliance with the instructions given in BEHRINGER user or service manuals.

▲ connection or operation of the unit in any way that does not comply with the technical or safety regulations applicable in the country where the product is used.

▲ damages/defects caused by force majeure or any other condition that is beyond the control of BEHRINGER.

5. Any repair or opening of the unit carried out by unauthorized personnel (user included) will void the warranty.

6. If an inspection of the product by BEHRINGER shows that the defect in question is not covered by the warranty, the inspection costs are payable by the customer.

7. Products which do not meet the terms of this warranty will be repaired exclusively at the buyer's expense. BEHRINGER will inform the buyer of any such circumstance. If the buyer fails to submit a written repair order within 6 weeks after notification, BEHRINGER will return the unit C.O.D. with a separate invoice for freight and packing. Such costs will also be invoiced separately when the buyer has sent in a written repair order.

§ 5 WARRANTY TRANSFERABILITY

This warranty is extended exclusively to the original buyer (customer of retail dealer) and is not transferable to anyone who may subsequently purchase this product. No other person (retail dealer, etc.) shall be entitled to give any warranty promise on behalf of BEHRINGER.

§ 6 CLAIM FOR DAMAGES

Failure of BEHRINGER to provide proper warranty service shall not entitle the buyer to claim (consequential) damages. In no event shall the liability of BEHRINGER exceed the invoiced value of the product.

§ 7 OTHER WARRANTY RIGHTS AND NATIONAL LAW

1. This warranty does not exclude or limit the buyer's statutory rights provided by national law, in particular, any such rights against the seller that arise from a legally effective purchase contract.

2. The warranty regulations mentioned herein are applicable unless they constitute an infringement of national warranty law.

* Customers in the European Union please contact BEHRINGER Germany Support for further details.

The information contained in this manual is subject to change without notice. No part of this manual may be reproduced or transmitted in any form or by any means, electronic or mechanical, including photocopying and recording of any kind, for any purpose, without the express written permission of BEHRINGER Spezielle Studiotechnik GmbH.

BEHRINGER, EURODESK and ULTRA-CURVE are registered trademarks. ALL RIGHTS RESERVED.

© 2002 BEHRINGER Spezielle Studiotechnik GmbH.

BEHRINGER Spezielle Studiotechnik GmbH, Hanns-Martin-Schleyer-Str. 36-38, 47877 Willich-Münchheide II, Germany

Tel. +49 (0) 21 54 / 92 06-0, Fax +49 (0) 21 54 / 92 06-30

I/O channel architecture

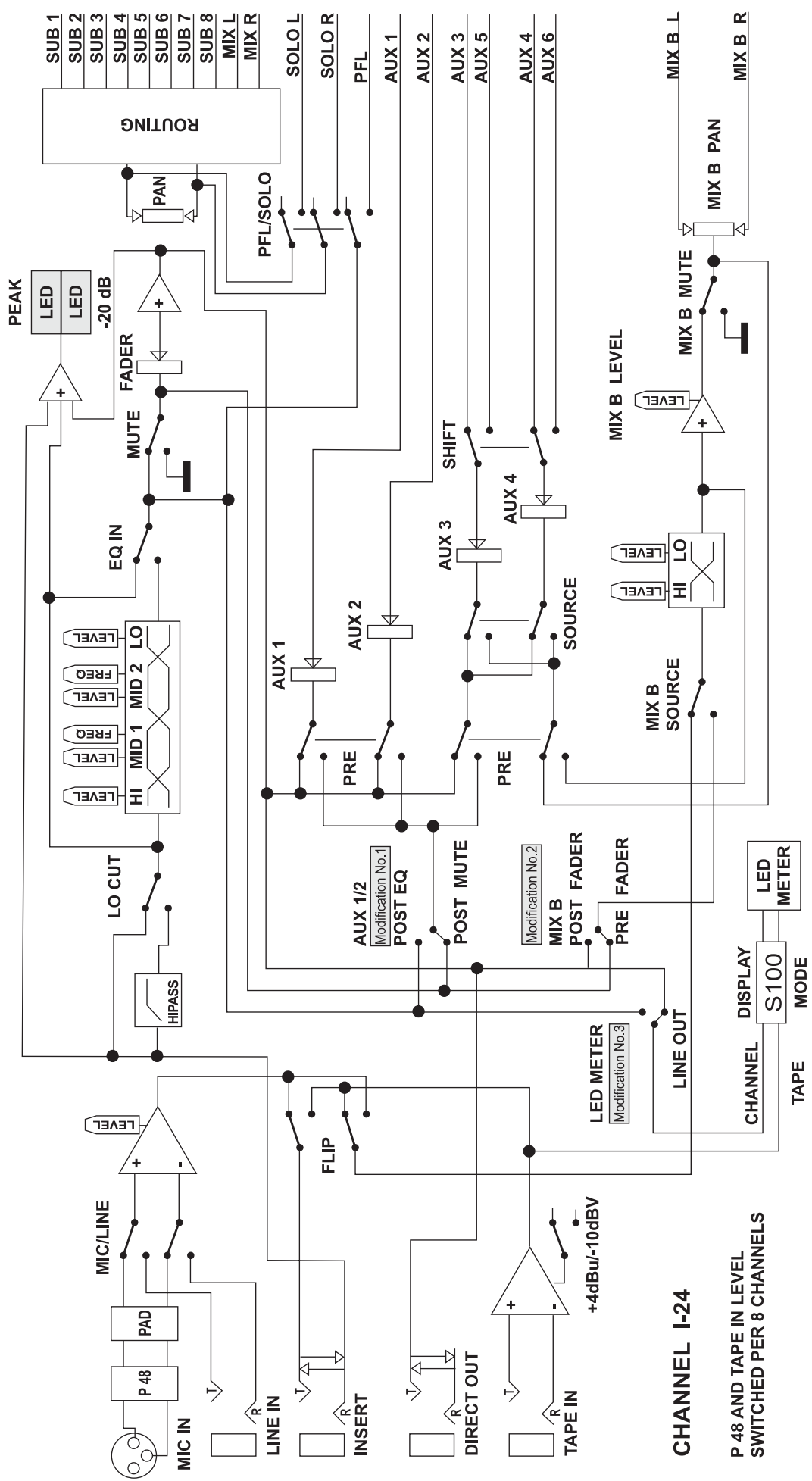

CHANNEL I-24

P 48 AND TAPE IN LEVEL SWITCHED PER 8 CHANNELS

