

CONCERT CDP2000-BK

User manual

A50-A0933-00001

en



www.behringer.com



Important Safety Instructions





This symbol, wherever it appears, alerts you to the presence of uninsulated dangerous voltage inside the enclosure - voltage that may be sufficient to constitute a risk of shock.



This symbol, wherever it appears, alerts you to important operating and maintenance instructions in the accompanying literature. Please read the manual.

en

Caution

-  To reduce the risk of electric shock, do not remove the top cover (or the rear section). No user serviceable parts inside. Refer servicing to qualified personnel.
-  To reduce the risk of fire or electric shock, do not expose this appliance to rain and moisture. The apparatus shall not be exposed to dripping or splashing liquids and no objects filled with liquids, such as vases, shall be placed on the apparatus.
-  These service instructions are for use by qualified service personnel only. To reduce the risk of electric shock do not perform any servicing other than that contained in the operation instructions. Repairs have to be performed by qualified service personnel.



- 1) Read these instructions.
- 2) Keep these instructions.
- 3) Heed all warnings.
- 4) Follow all instructions.
- 5) Do not use this apparatus near water.
- 6) Clean only with dry cloth.
- 7) Do not block any ventilation openings. Install in accordance with the manufacturer's instructions.
- 8) Do not install near any heat sources such as radiators, heat registers, stoves, or other apparatus (including amplifiers) that produce heat.
- 9) Do not defeat the safety purpose of the polarized or grounding-type plug. A polarized plug has two blades with one wider than the other. A grounding-type plug has two blades and a third grounding prong. The wide blade or the third prong are provided for your safety. If the provided plug does not fit into your outlet, consult an electrician for replacement of the obsolete outlet.
- 10) Place the power cord so that it is protected from being walked on and sharp edges. Be sure that the power cord is protected particularly at plugs, convenience receptacles and the point where it exits from the apparatus.
- 11) The apparatus shall be connected to a MAINS socket outlet with a protective earthing connection.
- 12) Where the MAINS plug or an appliance coupler is used as the disconnect device, the disconnect device shall remain readily operable.
- 13) Only use attachments/accessories specified by the manufacturer.
- 14) Use only with the cart, stand, tripod, bracket, or table specified by the manufacturer, or sold with the apparatus. When a cart is used, use caution when moving the cart/apparatus combination to avoid injury from tip-over. 
- 15) Unplug this apparatus during lightning storms or when unused for long periods of time.
- 16) Refer all servicing to qualified service personnel. Servicing is required when the apparatus has been damaged in any way, such as power supply cord or plug is damaged, liquid has been spilled or objects have fallen into the apparatus, the apparatus has been exposed to rain or moisture, does not operate normally, or has been dropped.

CONCERT

The Concert Series Digital Piano

- ▲ The ultimate piano for homes, music schools, houses of worship, etc. No traditional tuning or maintenance needed
- ▲ Elegant wood grain cabinet with black finish, sliding key cover and full modesty panel
- ▲ 88-note weighted hammer-action keyboard accurately recreates the feel of an acoustic grand piano
- ▲ High-grade 80-Watt speakers and cabinetry deliver a truly dynamic sound, rich with presence and power
- ▲ New stereo sampling RSM (Real Sound Modeling) tone generation for the ultimate in instrument realism
- ▲ 14 high-quality voices (Grand Piano, Acoustic Piano, E-Piano, Strings, Harpsichord, Organ, etc.) with max. 64-note polyphony
- ▲ Layer mode for playing 2 sounds together
- ▲ High-quality reverb, modulation and brilliance effects to add even more depth and richness
- ▲ Real-time 2-track song recorder with one song capacity and metronome
- ▲ 3 pedals (Damper, Sostenuto and Soft) for more dynamic playing
- ▲ Comprehensive MIDI In/Out/Thru and stereo Line In/Out connectors
- ▲ Dual headphone jacks for silent music rehearsal and student/tutor listening
- ▲ High-quality components and exceptionally rugged construction ensure long life
- ▲ Conceived and designed by BEHRINGER Germany

CDP2000-BK

Table of Contents

1. Introduction	5
1.1 Before you get started.....	5
1.1.1 Shipment.....	5
1.1.2 Initial operation.....	5
1.1.3 Online registration.....	5
2. Quick Start	5
2.1 Power on/off.....	5
2.2 Adjusting the volume.....	5
2.3 Demo playback.....	6
2.3.1 Playing back the sound demos.....	6
2.3.2 Playing back the piano music demos.....	6
2.4 Selecting and playing sounds.....	6
3. Control elements and connections	7
3.1 Control panel.....	7
3.2 Connectors.....	8
3.3 Foot pedals.....	8
3.4 Power supply.....	8
3.5 Headphone connectors.....	8
4. Basic operation	8
4.1 Using two sounds (layer mode).....	8
4.2 Changing the sound character.....	9
4.2.1 Brightness equalizer.....	9
4.2.2 Room effects.....	9
4.2.3 Modulation effects.....	9
4.3 Using the pedals.....	9
4.4 Using headphones.....	10
5. Advanced operation	10
5.1 Using EDIT mode.....	10
5.1.1 Quick access to layer mode functions.....	11
5.2 Transposition.....	11
5.3 Layer mode settings.....	11
5.3.1 Volume ratio.....	11
5.3.2 Detune.....	11
5.3.3 Transposition.....	12
5.3.4 Effect intensity.....	12
5.3.5 Reset.....	12
5.4 Using the metronome.....	12
5.4.1 Metronome volume.....	12
5.5 Music sequencer.....	13
5.5.1 Recording pieces of music.....	13
5.5.2 Editing pieces of music.....	13
5.5.3 Playing back pieces of music.....	14
5.5.4 Repeating musical passages for practicing.....	15
5.5.5 Setting the volume of muted tracks.....	15
5.5.6 Editing the music sequencer settings.....	15
5.5.7 Sync start.....	16
5.5.8 Start the music sequencer with foot pedal.....	16
5.6 System settings.....	16
5.6.1 Key velocity.....	16
5.6.2 Soft pedal intensity.....	17
5.6.3 Fine tuning.....	17
5.6.4 Tunings.....	17
5.6.5 Saving parameter settings.....	18
5.6.6 Restoring the factory default settings.....	18
6. Connection to external equipment	18
6.1 Connecting external sound sources.....	18
6.2 Connection to amplifiers and recording equipment.....	19
6.3 MIDI functions.....	19
6.3.1 MIDI connection to other sound modules.....	19
6.3.2 MIDI connection to a computer with sequencing software.....	20
6.3.3 MIDI settings.....	20
7. Troubleshooting	22
8. Specifications	23

9. Appendix	24
9.1 Cables.....	24
9.1.1 Unbalanced 1/4" cable.....	24
9.1.2 RCA cables.....	24
9.1.3 1/4" to RCA cable.....	24
9.1.4 MIDI cables.....	24
9.2 Presets on the CDP2000-BK.....	25
9.3 List of demo music pieces included.....	26
9.4 MIDI implementation chart.....	26
9.5 EDIT parameters.....	27
10. Warranty	28

Foreword



Dear Customer,

Welcome to the team of CONCERT users and thank you very much for expressing your confidence in BEHRINGER products by purchasing this digital piano.

It is one of my most pleasant tasks to write this letter to you, because it is the culmination of many months of hard work delivered by our engineering team to reach a very ambitious goal: to present you with an extraordinary digital piano that gives you maximum flexibility and performance with its unique sound character and broad range of functions.

The task to design the new CONCERT certainly meant a great deal of responsibility, which we assumed by focusing on you, the discerning user and musician. It also meant a lot of work and night shifts to accomplish this goal. But it was fun, too. Developing a product usually brings a lot of people together, and what a great feeling it is when everybody who participated in such a project can be proud of what we've achieved.

It is our philosophy to share our joy with you, because you are the most important member of the BEHRINGER team. With your highly competent suggestions for new products you've greatly contributed to shaping our company and making it successful. In return, we guarantee you uncompromising quality as well as excellent technical and audio properties at an extremely favorable price. All of this will enable you to fully unfold your creativity without being hampered by budget constraints.

We are often asked how we can produce such high-grade devices at such unbelievably low prices. The answer is quite simple: it's you, our customers! Many satisfied customers means large sales volumes enabling us to get better conditions of purchase for components, etc. Isn't it only fair to pass this benefit back to you? Because we know that your success is our success, too!

I would like to thank all people whose help on "Project CONCERT" has made it all possible. Everybody has made very personal contributions, starting from the designers of the instrument to the many staff members in our company and finally to you, the users of BEHRINGER products.

My friends, it's been worth the trouble!

Thank you very much,

Uli BEHRINGER

1. Introduction

Congratulations! With the CDP2000-BK you have purchased a master-class digital piano which is on a par with its acoustic counterpart in terms of sound and feel. The keyboard features 88 weighted keys with hammer action, in combination with the RSM stereo sound generator this gives you an unparalleled playing experience. High-quality modulation and room effects as well as a 2 x 40-Watt loudspeaker system produce a very natural and spacious sound. The 2-track sequencer for recording and practicing also includes a metronome and adds the finishing touch to the overall concept.

1.1 Before you get started

1.1.1 Shipment

Your CDP2000-BK was carefully packed at the factory, and the packaging was designed to protect the unit from rough handling. Nevertheless, we recommend that you carefully examine the packaging and its contents for any signs of physical damage that may have occurred during transit.

- 👉 **If the unit is damaged, please do NOT return it to BEHRINGER. Instead, notify your dealer and the shipping company immediately. Otherwise, claims for damage or replacement may not be honored.**
- 👉 **Always use the original packing carton to prevent damage during storage or transport.**
- 👉 **Make sure that no children are left unsupervised with the CDP2000-BK or its packaging.**
- 👉 **Please ensure proper disposal of all packing materials.**

1.1.2 Initial operation

Be sure that there is enough space around the unit for cooling and please do not place the CDP2000-BK on high temperature devices such as radiators etc. to avoid overheating.

- 👉 **Blown fuses must be replaced by fuses of the same type and rating! Please refer to the "SPECIFICATIONS" for details.**
- The mains connection of the CDP2000-BK is made by using the enclosed mains cable and a standard IEC receptacle. It meets all of the international safety certification requirements.
- 👉 **Please make sure that all units have a proper ground connection. For your own safety, never remove or disable the ground conductor from the unit or of the AC power cord.**
- 👉 **The CDP2000-BK is an electronic piano. Unlike an acoustic piano, this instrument does not need to be tuned.**
- 👉 **The sound quality may diminish within the range of powerful broadcasting stations and high-frequency sources. Increase the distance between the transmitter and the device and use shielded cables for all connections.**

1.1.3 Online registration

Please do remember to register your new BEHRINGER equipment right after your purchase by visiting www.behringer.com (alternatively www.behringer.de) and kindly read the terms and conditions of our warranty carefully.

Should your BEHRINGER product malfunction, our goal is to have it repaired as quickly as possible. To arrange for warranty service, please contact the retailer from whom the equipment was purchased. Should your BEHRINGER dealer not be located in your vicinity, you may directly contact one of our subsidiaries. Corresponding contact information is included in the original equipment packaging (Global Contact Information/European Contact Information). Should your country not be listed, please contact the

distributor nearest you. A list of distributors can be found in the support area of our website (www.behringer.com).

Registering your purchase and equipment with us helps us process your repair claims quicker and more efficiently.

Thank you for your cooperation!

2. Quick Start

2.1 Power on/off

The CDP2000-BK is a digital, i.e. electronic, piano. Therefore, mains power is required to operate the instrument and it has to be switched on or off. The following section describes how to connect the unit to the mains.

- 👉 **The POWER switch to the left of the keyboard must be in the "off" position when you connect the unit to the mains.**

FUSE HOLDER / IEC RECEPTACLE

The CDP2000-BK is connected to the mains using a standard IEC receptacle. All required safety regulations have been adhered to. A matching power cable is included with the unit. Blown fuses must be replaced with a fuse of the same type and rating.

- 1) Connect the power cable supplied with the unit to the connector provided on the underside of the instrument and to a wall socket
- 2) Press the POWER switch to the left of the keyboard to switch the instrument on or off. The LED on the front panel lights up when the CDP2000-BK is ready for operation.

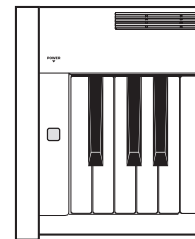

- 👉 **After playing, switch off the unit with the POWER switch. The POWER LED on the front panel will go out. Please note: Merely switching the unit off does not mean that it is fully disconnected from the mains. If you do not plan to use your piano for a prolonged period of time, please disconnect it from the mains by unplugging the power cable from the wall outlet.**

2.2 Adjusting the volume

The volume of the built-in loudspeakers and headphones can be adjusted as follows:

- 1) Set the MAIN VOLUME control to mid-travel position, between MIN and MAX.



- 2) Adjust the volume as desired by moving the control to the right (up) or left (down).

Caution

- 👉 **The CDP2000-BK is capable of producing extreme volumes. Please bear in mind that high sound pressures not only temporarily affect your sense of hearing, but can also cause permanent damage. Be careful to select a suitable volume at all times, particularly when you are playing with headphones.**

2.3 Demo playback

The CDP2000-BK offers you 14 sound and 15 piano music demos. These music pieces give you an impression of the instrument's versatility and range of sounds.

2.3.1 Playing back the sound demos

This section describes how to play back the 14 sound demos. These demos are specially designed to highlight the various sounds and their features and show you what can be done with your instrument.

- 1) Press the DEMO button.



- 2) Press one of the 14 buttons in the SOUND SELECT section to play back an audio demo of the selected sound color.

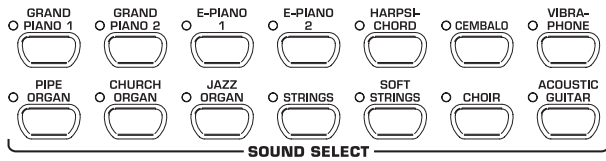

- Press the DEMO button again to quit DEMO mode.

- During demo playback the CDP2000-BK does not receive or send MIDI data.

- The music sequencer (see chapter 5.5) must not be set to playback or record-ready mode when you switch to DEMO mode.

2.3.2 Playing back the piano music demos

The following section describes how to play back the 15 piano music demos. These demos show you the versatility of the GRAND PIANO sounds.

- 1) Press the DEMO button.



- 2) Use the -/NO and +/YES buttons in the VALUE/SONG section to select the music piece of your choice.

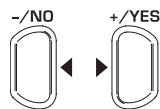

VALUE/SONG

The display reads:

- 1 ... 15:** Number of the selected music piece.
- ALL:** Playback of all music pieces. The pieces are played in chronological order.
- 5hF:** Playback of all music pieces. The pieces are played in random order.

- 3) Press the START/STOP button in the SONG section to start playback.

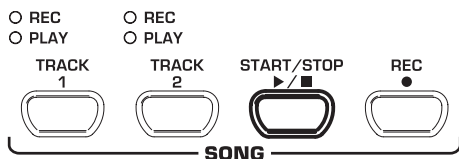

- 4) Press the START/STOP button again to stop playback.

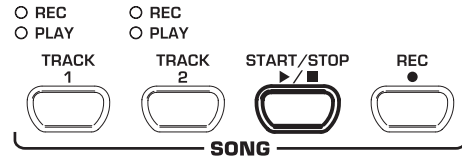

- 5) Repeat steps 2 to 4 to play back other pieces.

- Press the DEMO button again to quit DEMO mode.

- A list of all the music pieces can be found in chapter 9.3.

- The music sequencer (see chapter 5.5) must not be set to playback or record-ready mode when you switch to DEMO mode.

- You can adjust the playback tempo of the piano music demos (see chapter 5.4).

- Select any sound you like to accompany the piano music demos; you can also add the room, modulation and brilliance effects (see chapter 4.2). Select and set the sound colour before you enter DEMO mode.

2.4 Selecting and playing sounds

The CDP2000-BK comes with 14 different sound colours covering a wide spectrum of sounds. You can select a sound in the SOUND SELECT section.

- 1) Press one of the 14 buttons in the SOUND SELECT section to select the sound of your choice.

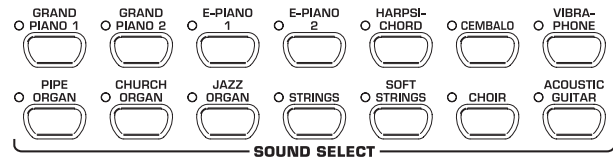

The LED above the sound button lights up to show that the corresponding sound has been selected. The selected sound can be played over the entire keyboard.

- The volume of the sound depends on how heavily you play the keys (not applicable to HARPSICHORD, CEMBALO, JAZZ ORGAN, CHURCH ORGAN and PIPE ORGAN).

- TIP:** You can also select two sounds at the same time.

3. Control elements and connections

3.1 Control panel

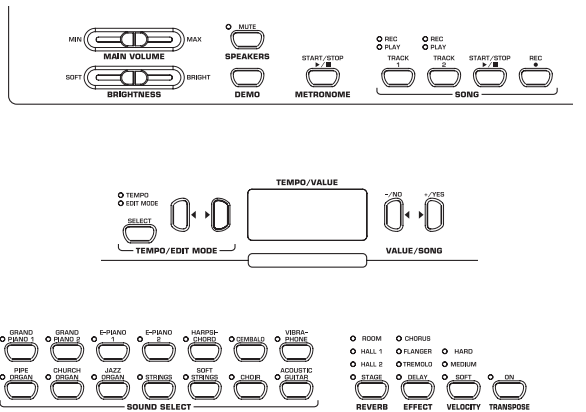
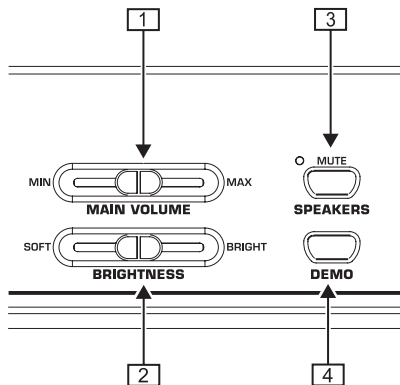
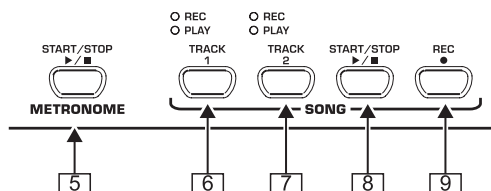

Fig. 3.1: Control elements of the CDP2000-BK

The control elements of the CDP2000-BK are described below. To give you a clear overview of the control panel, its elements have been grouped in separate sections.



- 1 MAIN VOLUME: Is used to adjust the volume of the built-in loudspeakers, headphone outputs and LINE OUT 1/4" TRS jacks.
- 2 BRIGHTNESS: Varies the sound character from soft (left) to bright (right).
- 3 SPEAKERS: Switches the built-in loudspeakers on and off. The MUTE LED lights up only when the built-in loudspeakers are switched off. When you insert your headphones this will automatically switch off the built-in loudspeakers.
- 4 DEMO: Enables/disables DEMO mode.



- 5 METRONOME: Is used to start/stop the metronome click.
- 6 TRACK 1: Selects track 1 for playback or recording. The REC LED lights up when the track has been activated for recording. The PLAY LED lights up when the track has been set for playback and already contains musical data.
- 7 TRACK 2: Selects track 2 for playback or recording. The REC LED lights up when the track has been activated for recording. The PLAY LED lights up when the track has been set for playback and already contains musical data.
- 8 START/STOP: Is used to start/stop playback or recording of the music sequencer.
- 9 REC: Activates record mode.

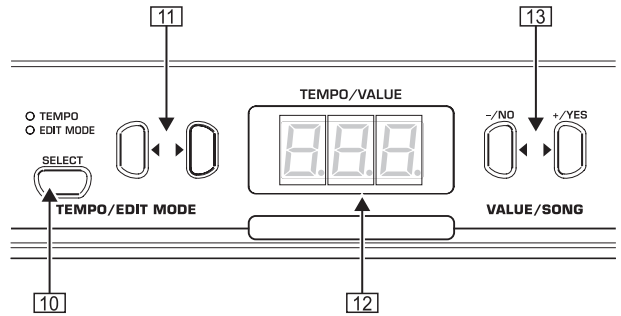

- 10 SELECT: Selects the TEMPO parameter and menu pages for EDIT mode. The EDIT MODE LED shows in EDIT mode, the TEMPO LED in TEMPO mode.
- 11 ◀ ▶: Depending on which mode you have selected with the SELECT button, these two buttons can be used to enter the tempo or to scroll through the EDIT mode menu pages.
- 12 Display: Depending on the function used, the display reads the tempo, menu numbers or parameter values.
- 13 -/NO, +/YES: Is used to raise/lower the parameter values shown in the display. Additionally, the +/YES button executes certain EDIT functions.

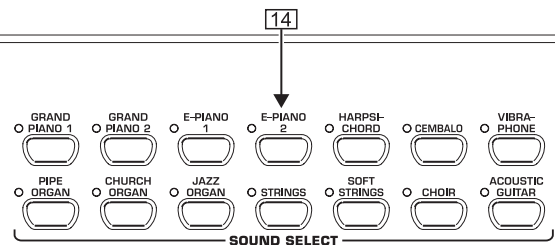

- 14 SOUND SELECT: These 14 buttons are used for sound selection. In DEMO mode they are used to select individual sound color demos.

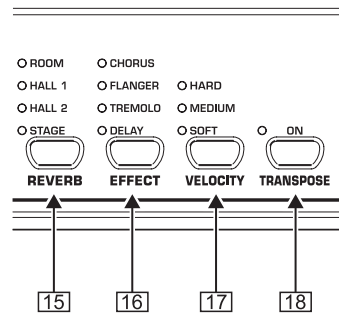

- 15 REVERB: Selects one of four room effects (ROOM, HALL 1, HALL 2, STAGE) for the selected sound. An LED shows which effect is currently active. If no LED lights up, no room effect is active.
- 16 EFFECT: Is used to select one of four modulation effects (CHORUS, FLANGER, TREMOLO, DELAY) for the selected sound. An LED shows which effect is currently active. If no LED lights up, no modulation effect is active.
- 17 VELOCITY: Is used to set the key velocity to SOFT, MEDIUM or HARD. An LED shows which setting is currently active. If no LED lights up, no key velocity has been selected and playing a key always triggers a fixed volume level, irrespective of how hard you play the key.
- 18 TRANSPOSE: Is used for setting keyboard/pitch transposition.

3.2 Connectors

The connectors of the CDP2000-BK are located on the underside of the playing console (center).

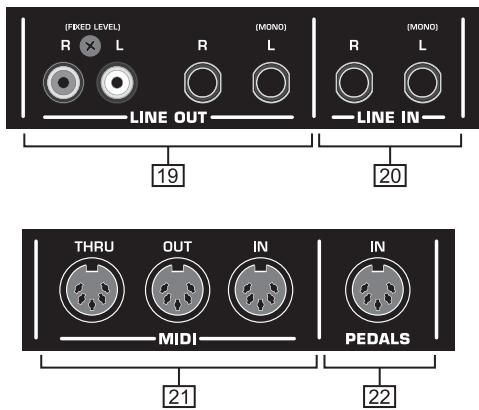
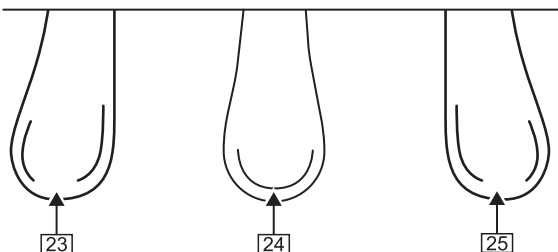

Fig. 3.2: Connectors of the CDP2000-BK

- 19** LINE OUT: There are two LINE OUT jacks available to send signals from the CDP2000-BK to other equipment.
 - ▲ 1/4" jacks: Use the 1/4" jacks to route the sounds of devices connected to the LINE IN jacks to the output of the CDP2000-BK. The level of the output signal depends on the position of the MAIN VOLUME control.
 - ▲ RCA jacks: The RCA jacks solely provide the sounds of the CDP2000-BK, but at a fixed volume level. Signals fed in via the LINE IN jack are not present here.
- 20** LINE IN: Is used to connect feeding devices such as CD players, sound cards or drum computers. The connected signal sources are routed to the LINE OUT 1/4" jacks and to the built-in loudspeakers.
- 21** MIDI: The three MIDI jacks enable you to connect external MIDI devices such as synthesizers, sequencers, etc. to the CDP2000-BK.
 - ▲ MIDI data controlling the sound generator of the CDP2000-BK are received at the IN jack.
 - ▲ MIDI data generated by the keyboard, pedals and some control elements of the CDP2000-BK are sent from the OUT jack.
 - ▲ Use the THRU jack to route MIDI data received at the MIDI IN to the MIDI OUT without changing them. This jack can be used to connect additional MIDI devices.
- 22** PEDALS: Connector for the pedal unit of the CDP2000-BK.

3.3 Foot pedals

The CDP2000-BK has three pedals similar to those found on acoustic grand pianos.



- 23** Soft/Piano pedal: Is used for passages to be played very softly.
- 24** Sostenuuto pedal: Is used to sustain tones that have been played before the pedal is pressed, but have not yet decayed. All tones played after the pedal is pressed decay normally.
- 25** Dampner/Forte pedal: Is used to sustain tones already played but not yet decayed. All tones played after the pedal is pressed will also be sustained.

3.4 Power supply

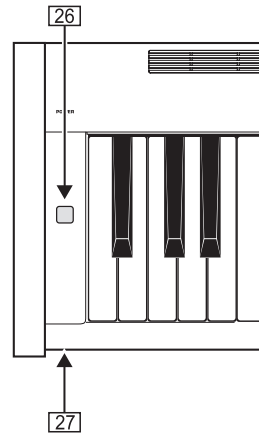

- 26** POWER: Switches the CDP2000-BK on and off.
 - ⚠ **Merely switching the unit off does not mean that it is fully disconnected from the mains. If you do not plan to use your piano for a prolonged period of time, please disconnect it from the mains by unplugging the power cable from the wall outlet.**
- 27** LED: Lights up when the CDP2000-BK is ready for operation.

3.5 Headphone connectors

The headphone connectors are located on the underside of the playing console (front left).



- 28** Use these jacks to connect your headphones. It is not possible to control the volume separately.

4. Basic operation

The following chapters describe some further basic functions which you can use in addition to those already explained.

4.1 Using two sounds (layer mode)

Instead of a single sound you can also play two sounds simultaneously on the CDP2000-BK. These sounds are layered and can be played together over the entire keyboard.

- 1) In the SOUND SELECT section, simultaneously press the buttons of the sounds to be layered.

The LEDs above the buttons light up to show that the associated sounds have been selected.

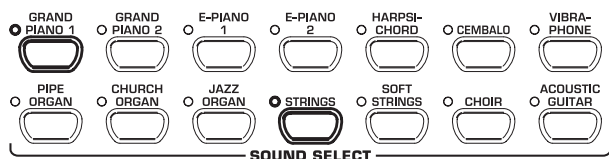

In our example the sounds „GRAND PIANO 1" and „STRINGS" are layered.

- ⚠ **To quit layer mode, press any button in the SOUND SELECT section. This will also select one single sound again.**

4.2 Changing the sound character

You can change the sound character by using a room and a modulation effect as well as a brightness equalizer.

4.2.1 Brightness equalizer

Use the brightness equalizer to change the sound character and make it softer or more brilliant.

- 1) Change the sound character with the BRIGHTNESS control as follows:
 - ▲ Move the control to the left (SOFT) for a softer sound that is darker in tone.
 - ▲ Move the control to the right (BRIGHT) for a more brilliant sound.



4.2.2 Room effects

The CDP2000-BK provides room effects simulating four reverb rooms of different sizes. When you select a sound, the CDP2000-BK also selects an appropriate effect. If required, however, you can always select any other effect. The following reverb room simulations are available:

- ROOM:** Simulates a small room.
- HALL 1:** Simulates a small concert hall.
- HALL 2:** Simulates a large concert hall.
- STAGE:** Simulates a typical stage ambience.

- 1) Keep pressing the REVERB button until the effect of your choice has been selected.

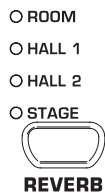

The active effect is shown by an LED lighting up next to the effect name.

If none of the four LEDs lights up, the room effect is disabled.

- 2) Keep the REVERB button pressed while adjusting the original vs. effect signal ratio in the VALUE/SONG section using the -/NO and +/YES buttons.

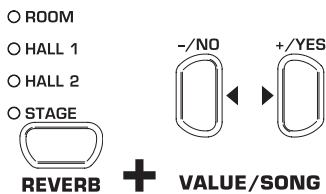

The display reads:

0 ... 20: Effect intensity
(0 = no effect, 20 = maximum effect)

- 3) If you want to restore the default settings, keep the REVERB button pressed, then press -/NO and +/YES simultaneously.



4.2.3 Modulation effects

The CDP2000-BK provides a modulation effect featuring four different types of effect. When you select a sound, the CDP2000-BK automatically adds an appropriate effect for some of the sounds. If required, however, you can always select any other effect. The following modulation effects are available:

- CHORUS:** Chorus effect. „Widens" the sound.
- FLANGER:** Time-shifted layering of sounds. Produces a "floating" sound.
- TREMOLO:** Rapid, constantly repeated changes in the volume of the sound.
- DELAY:** Echo effect. Produces time-shifted repetitions of the sound that decay over time.

- 1) Keep pressing the EFFECT button until the effect of your choice has been selected.



The selected effect is shown by an LED lighting up next to the effect name.

If none of the four LEDs lights up, the modulation effect is disabled.

- 2) Keep the EFFECT button pressed while adjusting the original vs. effect signal ratio in the VALUE/SONG section using the -/NO and +/YES buttons.

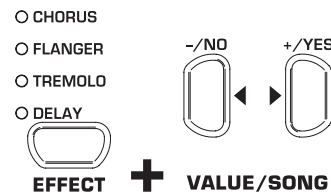

The display reads:

0 ... 20: Effect intensity
(0 = no effect, 20 = maximum effect)

- 3) If you want to restore the default settings, keep the EFFECT button pressed, then press -/NO and +/YES simultaneously.

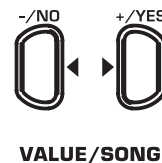

4.3 Using the pedals

The CDP2000-BK is equipped with three foot pedals performing the same functions as the pedals on an acoustic grand piano. Normally, the pedals are used in accordance with the instructions given in the music, where they are marked by special symbols. It is useful to know how sound is produced on an acoustic piano to better understand how the pedals work.

When you strike a key, a hammer hits several strings for each note; the strings produce a tone with a defined pitch. When you let go of the key, a damper felt falls down on the strings to stop them from vibrating any longer. As a result, the tone decays quickly. However, if the key is held down, the tone is sustained for a while before it decays completely. In this case, the tone decays only after a certain time.



CONCERT CDP2000-BK

This decay characteristic can be influenced using the three foot pedals.

- ▲ **Soft/piano pedal (left):** The soft pedal produces a soft and intimate sound. Use this pedal for particularly soft musical passages (pianissimo).

On an acoustic piano this soft sound results from a smaller distance between hammer and strings. On a grand piano, however, the position of the hammer changes, so that the hammer does not hit all strings.

- 1) Press the pedal to dampen all tones played afterwards with the pedal down.
- 2) Let go of the pedal for normal playing.

☞ **You can adjust the effect of the damper pedal (see chapter 5.6.2).**

- ▲ **Sostenuto pedal (middle):** Use the sostenuto pedal to sustain individual tones. The notes already played – as long as they have not yet decayed – will be sustained as soon as you press the pedal. All notes played subsequently will be dampened as described above. This allows you to play and sustain a certain note using the pedal, while all subsequent tones will be played in a staccato (detached) manner.

When you sustain single notes on an acoustic piano using the sostenuto pedal, the damper felts of the notes already played do not dampen the strings when you release the keys, but are held in their position.

- 1) Play the notes to be sustained.
- 2) Press the pedal to sustain the tones you just played.
- 3) Play the next notes. These are played with normal decay.
- 4) Release the pedal for normal playing.

- ▲ **Damper/Forte pedal (right):** The damper pedal allows you to sustain the notes already played (and held) plus all subsequent notes, without having to hold the keys down. The damper pedal is often used to achieve a richer sound. This is the pedal that is used most often. You can also use it very subtly, for example, by holding it down only half-way.

On the acoustic piano notes are sustained by keeping all the damper felts in their raised position even after releasing the keys. This allows the notes played to decay quite naturally.

- 1) Play the notes to be sustained.
- 2) Press the pedal to sustain the notes you just played plus all subsequent notes.
- 3) Release the pedal for normal playing.

4.4 Using headphones

The CDP2000-BK is equipped with two headphone jacks located on the underside of the playing console (front left). Headphones are ideal for practising without disturbing others. The second headphone jack allows another person, for example a music teacher, to listen as well so that piano lessons can also be held using headphones.

- 1) Use the MAIN VOLUME control to turn the volume down (move the slide control to the left half of its control range).



- 2) Connect your headphones to a free headphone jack on the underside of the playing console.
- 3) While playing adjust the volume as desired using the MAIN VOLUME control.



- 4) If required, the SPEAKERS button allows you to switch the built-in loudspeakers of the CDP2000-BK on or off.



☞ **The built-in loudspeakers of the CDP2000-BK are switched off as soon as you connect a pair of headphones; the MUTE LED above the SPEAKERS button lights up.**

☞ **When you disconnect your headphone from the headphones jack, the built-in loudspeakers of the CDP2000-BK are switched on again and the MUTE LED above the SPEAKERS button goes out.**

5. Advanced operation

The following chapters provide information on advanced operating functions of the CDP2000-BK.

5.1 Using EDIT mode

Many advanced operating functions of the CDP2000-BK are available in EDIT mode. The following sections describe how to adjust these functions in EDIT mode.

☞ **Whenever you are prompted to enter EDIT mode, please follow the step-by-step instructions given below to select a function and adjust its parameters.**

- 1) Keep pressing the SELECT button in the TEMPO/EDIT MODE section until the EDIT MODE LED lights up.



- 2) Scroll through the functions using the ◀ ▶ buttons, until the appropriate function (e.g. E ♯) has been selected.

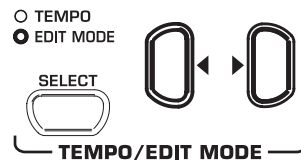

- 3) Use the -/NO- and +/YES buttons in the VALUE/SONG section to adjust the value of your choice.

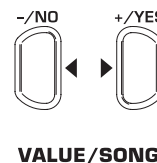

5.1.1 Quick access to layer mode functions

Use the following operating procedure for direct access to the layer mode menu pages.

- 1) Press and hold down the two sound buttons selected for layer mode (e.g. GRAND PIANO 1 and STRINGS) and press the SELECT button in the TEMPO/EDIT MODE section.

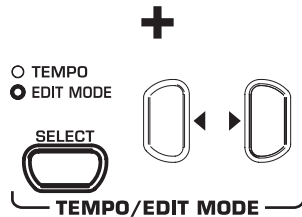
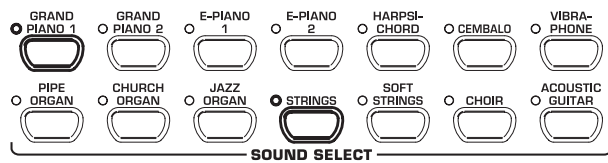

The EDIT MODE LED lights up and the EDIT page E3.1 is displayed.

5.2 Transposition

The sounds produced by the CDP2000-BK can be transposed up or down by half-tones (key by key). This is useful, for example if you want to play a piece in a key that is easier to play because it has few or no accidentals at all (e.g. C major), but intend the piece is to sound in a difficult key with lots of accidentals (e.g. D flat major).

Example: D flat major has five flats (accidentals). In this key you would have to play a lot of black keys. However, if you transpose the sounds up by one half-tone, you can easily play the piece on the white keys (C major).

It can be helpful to transpose the keyboard by an octave (12 half-tones), for example to play low notes in the middle register where they can be played more comfortably.

- 1) Press and hold the TRANSPOSE button and use the -/NO and +/YES buttons in the VALUE/SONG section to adjust the transposition value of your choice in half-tone steps.

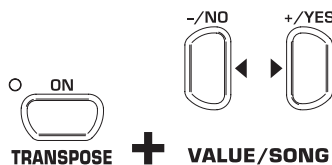

The display reads:

- 0: No transposition (default setting)
- 1 ... 12: Keyboard is transposed up by the number of half-tones selected.
- 1 ... - 12: Keyboard is transposed down by the number of half-tones selected.

- 2) Release the TRANSPOSE button when the desired value has been selected.

The LED above the TRANSPOSE button lights up when the transposition feature is active, i.e. when a value other than zero has been set.

If a transposition interval has already been set, you can enable/disable the transposition function using the TRANSPOSE button.

5.3 Layer mode settings

In layer mode you can effect additional settings for advanced playing with two sounds at the same time.

All sounds are numbered internally from 1 through 14. This order of sounds determines which sound is addressed internally as voice #1, voice #2, etc., which in turn is important for making changes to the sounds selected.

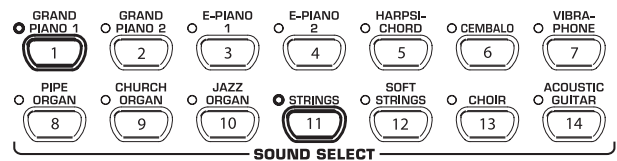

In our example the two sounds GRAND PIANO 1 and STRINGS are being used in layer mode. Internally, GRAND PIANO 1 is #1, STRINGS is #11. The sound with the lower number is addressed internally as voice #1 (here: GRAND PIANO 1), the sound with the higher number as voice #2 (here: STRINGS).

Please note the order of voices used in the sound combination selected, in order to understand which settings apply to which voice in the examples below.

A layer combination consisting of two sounds must be set up before you can adjust the following functions (see chapter 4.1).

5.3.1 Volume ratio

Use this function to adjust the volume ratio of the selected sounds.

Please enter EDIT mode (see chapter 5.1) and select the following function.

Function: E3.1

Value: 0 ... 20

Description:

- 0: Same volume for voice #1 and voice #2
- ... 10: Voice #2 louder than voice #1
- 10 ...: Voice #1 louder than voice #2

5.3.2 Detune

This function allows you to detune the selected sounds slightly against each other.

Please enter EDIT mode (see chapter 5.1) and select the following function.

Function: E3.2

Value: - 10 ... 10

Description:

- 0: Same pitch for voice #1 and voice #2
- ... 10: Voice #2 higher than voice #1
- 10 ...: Voice #1 higher than voice #2

5.3.3 Transposition

Use this function to transpose the selected sounds up or down by one octave. Depending on which sounds are used in a combination, the transpose function can help make the sounds more homogeneous.

Example:

In a combination of GRAND PIANO 1 and STRINGS the STRINGS sound too low. In this case, it helps to transpose the STRINGS up by one octave.

Please enter EDIT mode (see chapter 5.1) and select the following function.

Function: E3.3 (voice #1 transposed by an octave)
E3.4 (voice #2 transposed by an octave)

Value: -1 ... 1

Description:

- 0: No transposition
- 1: Transposition down by one octave
- 1: Transposition up by one octave

5.3.4 Effect intensity

This function allows you to edit the effect intensity of the modulation effect for the selected sounds.

Please enter EDIT mode (see chapter 5.1) and select the following function.

Function: E3.5 (effect intensity voice #1)
E3.6 (effect intensity voice #2)

Value: 0 ... 20

Description:

- 1 ... 20: Effect intensity (default setting)
- 0: No effect

5.3.5 Reset

Use this function to reset all settings in layer mode.

Please enter EDIT mode (see chapter 5.1) and select the following function.

Function: E3.7

Value: -

Description:

Press the +/YES button to execute this function.

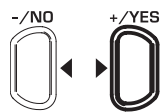

VALUE/SONG

5.4 Using the metronome

The CDP2000-BK features a built-in metronome which can be used for practising or to make recordings with the internal music sequencer.

To use the metronome, please proceed as follows :

- 1) Press the METRONOME button to start or stop the metronome.



METRONOME

The metronome beats are shown by flashing dots on the display. At the beginning of a measure all dots light up simultaneously.

- 2) Keep pressing the SELECT button in the TEMPO/EDIT MODE section until the TEMPO LED lights up.

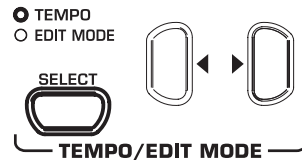

- 3) Use the two < and > buttons to adjust a tempo of your choice.



- 4) Press and hold the METRONOME button while adjusting the number of beats per measure using the -/NO and +/YES button in the VALUE/SONG section.

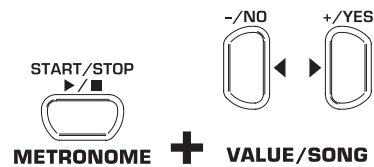

The display reads:

- 04: No stressed beats (default setting)
- 24, 34, 44, 54, 64, 74: Quarter meter (e. g. 2/4)
- 38, 68, 78, 98, 128: Eighth-note meter (e. g. 3/8)

5.4.1 Metronome volume

Use this function to adjust the metronome volume.

Please enter EDIT mode (see chapter 5.1) and select the following function.

Function: E5

Value: 1 ... 20

Description:

- 1 ... 20: Metronome volume (1 = low, 20 = high)

Proceed as follows for direct access to the metronome volume menu page.

- 1) Press and hold the METRONOME button, then hit the SELECT button in the TEMPO/EDIT MODE section.



METRONOME



The EDIT MODE LED lights up and the EDIT page E5 is displayed.

5.5 Music sequencer

The CDP2000-BK provides a built-in 2-track sequencer which allows you to record and play back a piece of music. For each of the two tracks you can select one or two sounds for recording. This means that the music sequencer can play back up to four sounds at the same time. While playing back a music piece you can also play on the keyboard to produce complex performances with up to six different sounds.

What is more, you can use the music sequencer for practising. For example, you could record the left and right-hand parts of a piece separately on the two tracks. During playback switch off one track (=hand) and play the muted part yourself. Thus, you can practice each part individually within its musical context.

5.5.1 Recording pieces of music

This section describes how to record music pieces with the built-in music sequencer.

- 1) Press the REC button. The REC LED above the TRACK-1 or TRACK-2 button lights up. The dots in the display start flashing in the adjusted metronome tempo, thus indicating the beat. Now, the CDP2000-BK is set to record mode.

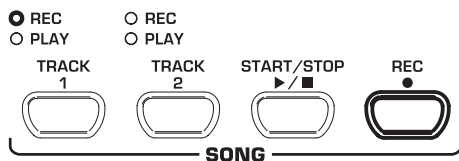

The memory of the music sequencer can store up to 10,000 notes. However, this number can decrease depending on how much pedaling information is stored.

You can quit record mode by pressing the REC button again.

- 2) If necessary, adjust the metronome tempo and meter as described in chapter 5.4.

- 3) Keep pressing the TRACK-1 button until the REC LED above the corresponding button lights up red. Now, track 1 is selected for recording. If you did a recording take before, the last track selected will be used for recording. Depending on which track is currently used, you will have to select the other track for recording.



TIP: If the PLAY LED for one of the tracks lights up, this warns you that notes have already been recorded on this track. If you select this track again for recording (REC LED lights up red), the previous recording will be lost.

- 4) Select a sound in the SOUND SELECT section. You can also use a sound combination (see chapter 4.1) for recording.

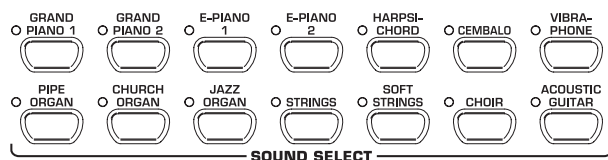

- 5) Switch on the acoustic metronome signal by pressing the METRONOME button.



- 6) Start recording by pressing the START/STOP button or simply start playing on the keyboard. The current meter is counted in the display.

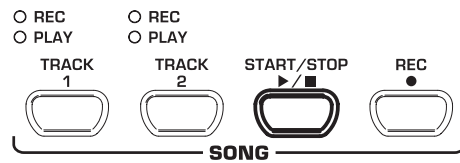

If the display starts flashing during recording and reads the message FULL, this is to warn you that the recording memory has been used up. All data recorded up to this point will be stored, but the recording process will be terminated.

- 7) Once your recording is finished stop the sequencer by pressing the START/STOP button again.

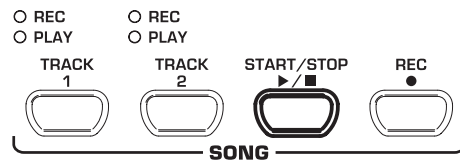

Recording mode will thus be canceled automatically.

- 8) Repeat the whole procedure to record a second track. This time, however, select TRACK 2 instead of TRACK 1 in step #3.

TIP: If the right-hand part of a music piece you want to practice has been recorded on track 2 and the left-hand part on track 1 (for example, by your piano teacher), you can mute one of the two tracks during playback to practice the corresponding part.

TIP: Press the METRONOME button again to stop the metronome click.

5.5.2 Editing pieces of music

This section describes how to edit a recording by replacing a recorded track with a new recording. What is more, you can see how to record a track without playing back the second track, which can be useful when you record two different pieces of music.

You must have recorded at least one track before you can carry out the steps described below.

If you are not sure whether a track has been recorded or not, check this by pressing the TRACK 1 and TRACK 2 button, BEFORE you enter record mode. If one of the PLAY LEDs above the TRACK buttons light up, this shows you that something has been recorded on this track.

- 1) If you do not want to hear the previously recorded track while you record the second one, press the TRACK button of the track until its green PLAY LED goes out. Do this BEFORE you enter record mode. If you want to hear the previously recorded track, continue with step #2.



- 2) Press the REC button. The REC LED above the TRACK 1 or TRACK 2 button lights up. The dots on the display start flashing in the metronome tempo that has been set, thus indicating the beat. Now, the CDP2000-BK is set to record mode.

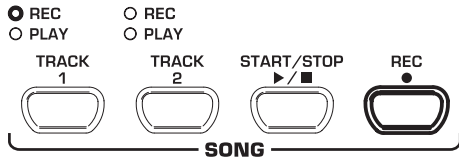

The memory of the music sequencer can store up to 10,000 notes. However, this number can decrease depending on how much pedaling information is stored.

You can quit record mode by pressing the REC button again.

- Press the TRACK button of the track you want to record until the REC LED above the button lights up red. Now the selected track is record-ready. If you did a recording take before, the last track selected will be used for recording. Depending on which track is currently used, you will have to select the other track for recording.

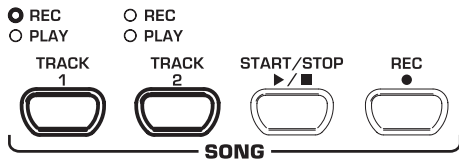

Tip: If you select a track for recording, which already contains note information, all previously recorded notes on this track will be erased!

- Select a sound in the SOUND SELECT section. You can also use a sound combination (see chapter 4.1) for recording.

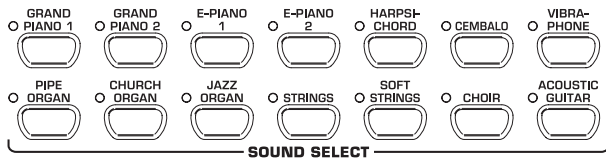

- Switch on the acoustic metronome signal by pressing the METRONOME button, if you want to make a metronome-backed recording.



- Start recording by pressing the START/STOP button or simply start playing on the keyboard. The current meter is constantly shown in the display.

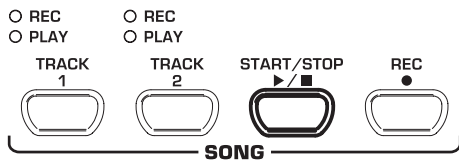

If the display starts flashing during recording and reads the message FULL, this is to warn you that the recording memory has been used up. All data recorded up to this point will be stored, however, but recording process will be terminated.

- Once your recording is finished stop the sequencer by pressing the START/STOP button again.

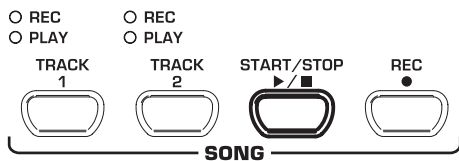

Recording mode will thus be canceled automatically.

5.5.3 Playing back pieces of music

This section describes how to play back the music piece you have just recorded.

- Press the TRACK 1 and TRACK 2 buttons until the green PLAY LED above the buttons lights up. This is to activate the tracks for recording.

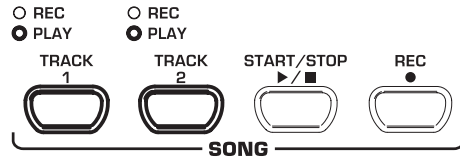

You can only activate those tracks for playback which actually contain note information.

- If you want to have a metronome-backed playback, press the METRONOME button to switch on the metronome.



- Press the SELECT button in the TEMPO/EDIT MODE section until the TEMPO LED lights up, then use the two left and right arrow buttons to adjust the playback tempo.

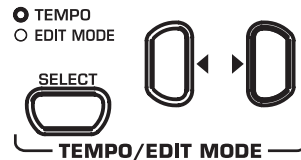

You can play back a recording at its original tempo by pressing the two left and right arrow buttons at the same time.

- Press the START/STOP button to play back the recording. The current meter is constantly shown in the display.

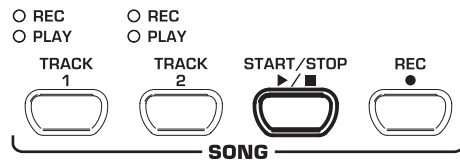

During playback the two tracks can be switched on/off at any time.

You can accompany the music sequencer playback with the currently selected sound.

TIP: If the right-hand part has been recorded on track 2 and the left-hand part on track 1, you can switch off either of the tracks and practice its part live during playback. The volume of the muted track is adjustable. If necessary you can play it back in the background at low volume for support (see chapter 5.5.5).

- To stop the playback, press the START/STOP button again.

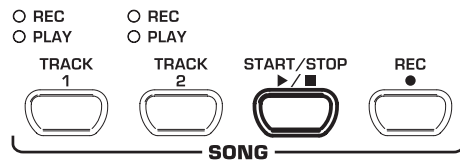

5.5.4 Repeating musical passages for practicing

The following section describes how to play back a specific passage of a recorded music piece repeatedly. This function is ideal for practicing a specific difficult passage recorded by your piano teacher.

To make the best use of this function, the left and right-hand parts should be recorded separately on tracks 1 and 2. In this case, you can play back one part only with the music sequencer, while you practice the other part.

- 1) Select the track to be played back, so that the PLAY LED above the corresponding TRACK button lights up.

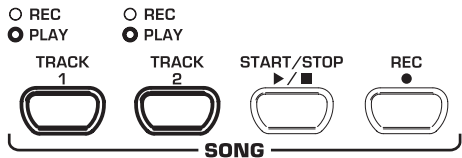

The volume of a muted track is adjustable (see chapter 5.5.5).

- 2) Press the START/STOP button to play back the selected track.

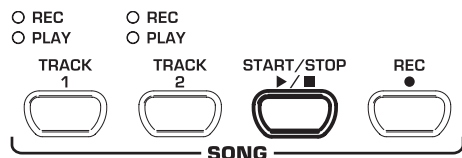

- 3) Press the SELECT button in the TEMPO/EDIT MODE section when the playback has reached the point from which you want to start repeating a passage.

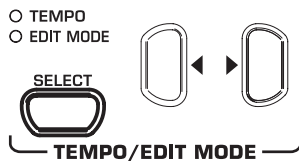

The display reads:

R-: Starting point of the loop is set.

- 4) Press the SELECT button again when the playback reaches the point where you want to end the repetition of a passage.

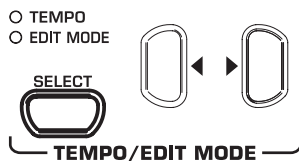

The display reads:

R-b: Ending point of the loop is set.

The musical passage is now repeated continuously, so that you can practice it to perfection.

- 5) When you want to stop practicing, press the START/STOP button again to stop the playback.

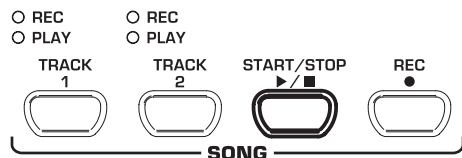

Press the SELECT button again to quit repetition mode.

The passage marked as a loop for repetition is automatically erased when you quit music sequencer mode.

5.5.5 Setting the volume of muted tracks

- 1) This function allows you to set the volume of muted tracks.

Please enter EDIT mode (see chapter 5.1) and select the following function.

Function: E6

Value: 0 ... 20

Description:

! ... 20: Volume of muted track (default setting: 5)

0: Muted tracks are not audible

5.5.6 Editing the music sequencer settings

The following paragraphs explain how to edit the playback settings of recordings made with the music sequencer.

The following settings can be edited separately for each of the two tracks:

- ▲ Sound (see chapter 2.4)
- ▲ Room effect intensity (see chapter 4.2.2)
- ▲ Modulation effect intensity (see chapter 4.2.3)
- ▲ Layered sounds (see chapters 4.1 and 5.3)

The following global settings can be made for the whole music piece:

- ▲ Tempo (see chapter 5.4)
- ▲ Meter (see chapter 5.4)
- ▲ Type of room effect (see chapter 4.2.2)
- ▲ Type of modulation effect (see chapter 4.2.3)

- 1) Press the REC button in the SONG section to enter record mode. The REC LED above the TRACK 1 or TRACK 2 buttons lights up and the dots in the display start flashing in the rhythm of the selected metronome tempo, thus indicating the beat.

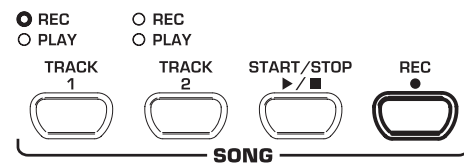

Be sure not to press the START/STOP button during the following steps. Otherwise, a new recording would be made on the selected track erasing all the data recorded before.

- 2) Use the TRACK button to select the track whose settings you wish to edit. If you want to edit global settings (e.g. tempo, measure, etc.) you can select either one of the two tracks.

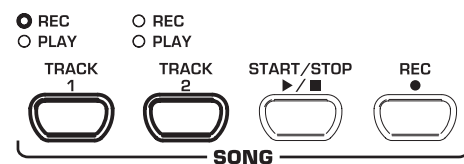

- 3) Edit the settings as described in the chapters mentioned above.

- 4) If necessary, repeat step 2 for the second track.

- 5) Press the REC button to quit record mode.

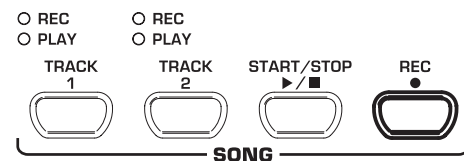

The changes made have now been stored in the music sequencer. When you play back the music piece, the new settings will be effective. All previous settings are deleted.

5.5.7 Sync start

You can set the music sequencer playback-ready, so that it will start playback as soon as you play a key on the keyboard. This function can be very helpful when the music sequencer is used as an „accompanist“. The function is also available in DEMO mode.

- 1) Make sure that the playback tracks are active (PLAY LED above the corresponding TRACK button lights up green). If necessary, activate the tracks by pressing their TRACK buttons in the SONG section.

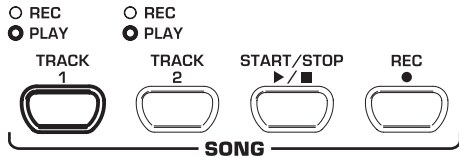

- 2) Press and hold one of the active TRACK buttons, then press the START/STOP button in the SONG section.

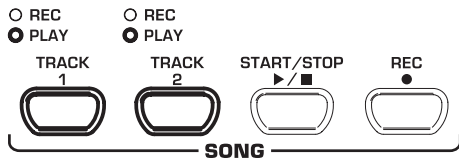

+

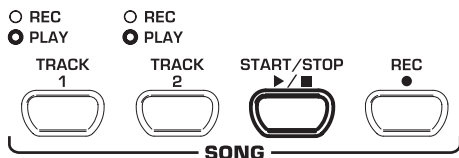

A dot in the lower right-hand corner of the display starts flashing in the tempo of the metronome, thus signaling that the instrument is set to sync start mode. The sequencer starts playback as soon as you play a key on the keyboard.

👉 If you want to quit sync start mode, simply repeat step 2.

5.5.8 Start the music sequencer with foot pedal

This function allows you to reprogram the left soft pedal, so that it can be used to start/stop the music sequencer. This is useful when you are playing a music piece live and want to start a sequencer accompaniment at a later point during the piece. When the pedal has been set accordingly, you can also use it to start/stop playback in DEMO mode.

👉 Please enter EDIT mode (see chapter 5.1) and select the following function.

Function: E4.1

Value: 1, 2

Description:

- 1: Soft pedal function (default setting)
- 2: Music sequencer START/STOP

5.6 System settings

The CDP2000-BK provides several setting options to control the global functions of the instrument. Please read below which options are available and how you can edit their settings.

5.6.1 Key velocity

This parameter determines the volume of the sounds with reference to the key velocity applied, i.e. you can set here how hard you have to strike a key to achieve maximum volume.

The following section describes how to change the key velocity.

- 1) Press the VELOCITY button to select one of the following settings:

HARD: The keys must be played very hard to achieve maximum volume.

MEDIUM: The keys must be played with medium velocity to achieve maximum volume (default setting).

SOFT: The keys must be played only lightly to achieve maximum volume.

OFF: If none of the LEDs lights up, each key stroke will produce a defined volume, irrespective of how hard you play the keys.



An LED above the button lights up to show the current setting. If all LEDs are out, key velocity is switched off. In this case you can adjust a fixed volume level as follows:

- 2) Press and hold the VELOCITY button, then use the -/NO and +/YES buttons to set the volume level to be produced when you play a key on the keyboard, irrespective of the key velocity applied.

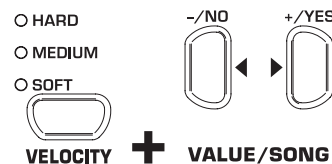

The display reads:

1 ... 127: Fixed volume level produced when you play a key on the keyboard (default setting: 64)

- 3) Keep the VELOCITY button pressed, then press the -/NO and +/YES buttons simultaneously to recall the standard setting.



👉 The key velocity setting has no effect on the following sounds: HARPSICHORD, CEMBALO, JAZZ ORGAN, CHURCH ORGAN and PIPE ORGAN.

👉 TIP: young pianists might find it easier to use a SOFT key velocity setting.

5.6.2 Soft pedal intensity

Use this function to adjust the intensity of the soft pedal effect.

Please enter EDIT mode (see chapter 5.1) and select the following function.

Function: E4.2

Value: 1 ... 5

Description:

- 3: Normal soft pedal intensity (default setting)
- 4: Low soft pedal intensity
- 5: High soft pedal intensity

The function will be effective only if the left pedal is used as a soft pedal, but NOT to start/stop the music sequencer (see chapter 5.5.8).

5.6.3 Fine tuning

The CDP2000-BK can be detuned slightly to adapt it to other instruments or tunings. The setting made here affects the pitch of all keys.

The following section describes how to adjust the fine tuning of the CDP2000-BK. The tuning shown in the display is referenced to the concert pitch „A“ in Hertz (Hz).

Please enter EDIT mode (see chapter 5.1) and select the following function.

Function: E 1

Value: 427 ... 453

Description:

- 440: Western European equal tuning (default setting)
- 453: Maximum detuning upwards
- 427: Maximum detuning downwards

1/5-Hz steps are shown as follows (figures separated by one or two dots):

- 440: 440 Hz
- 4.40: 440,2 Hz
- 44.0: 440,4 Hz
- 440.: 440,6 Hz
- 4.40.: 440,8 Hz

5.6.4 Tunings

The CDP2000-BK provides different tunings developed during the past few centuries. The tuning used most often today is called equal tuning and has been a characteristic element of the music composed from the 19th century up to the present. However, for some baroque pieces (e.g. by J. S. Bach) it can be interesting to use an older tuning system.

In the history of music, the development of the individual tunings can be traced back to the development of scales and polyphony and the resulting adaptation of instruments and their tuning. Apart from these historical reasons the limited tuning aids available in former times played an important role for the practical implementation of tunings.

The CDP2000-BK provides the following tunings:

► Equal tuning (default setting)

Equal tuning divides one octave into twelve intervals of equal size or spacing. Thus, each half-tone is detuned slightly to the same extent, with the octave being the only perfect interval. This has been the most common tuning since the 19th century, as it makes it possible to play all twelve major/minor keys.

► Pure major/minor intonation

This tuning is based on the perfect tuning of the seven notes of one scale (e.g. C major). Triads played one fifth above or below are also perfect, since they use the notes of the basic key. However, all other keys are not playable, since their frequency relationships change depending on the basic note.

This tuning can only be used for music that strictly follows a classical cadence comprising tonic, dominant and subdominant.

► Pythagorean tuning

The Pythagorean tuning is based on perfect fifths. As a consequence, all thirds are impure.

This tuning was used for early music up to the late Middle Ages. The homophonic or two-part polyphonic music of the time did not use any thirds, but only perfect unison, fourth, fifth and octave intervals.

► Meantone tuning

Meantone tuning resulted from the change in the perception of dissonant intervals during the Renaissance period and from the beginnings of chromaticism and polyphony. Polyphony made the third the most important interval in music. Therefore, meantone tuning is based on perfect thirds rather than perfect fifths to tune the twelve notes of a scale. However, this also means that some scales are unplayable.

Today, the meantone tuning can still be used for works from the early 16th and 17th centuries (e.g. G. F. Handel).

► Werckmeister/Kirnberger tuning

The Werkmeister and Kirnberger tunings result from first attempts to realize a well-tempered tuning which – unlike the Pythagorean and meantone tunings – allows for playing in all twelve keys. The advantages of the Pythagorean and meantone tunings, i.e. the slight detuning of some fifth intervals, have also been included in the Werkmeister/Kirnberger tunings

Both tunings are interesting to use for works from the baroque period (e.g. J. S. Bach). Werkmeister is a popular tuning for organ works.

The following section describes how to change the tuning of the CDP2000-BK.

Please enter EDIT mode (see chapter 5.1) and select the following function.

Function: E2.1

Value: 1 ... 7

Description:

- 1: Equal tuning (default setting)
- 2: Pure major tuning
- 3: Pure minor tuning
- 4: Pythagorean tuning
- 5: Meantone tuning
- 6: Werckmeister tuning
- 7: Kirnberger tuning

With the exception of equal tuning, all tunings must be marked by a basic note.

Here's how to set the basic note:

Function: E2.2

Value: c ... b

Description:

Altered notes are marked by dashes above or below the note name. A dash above the note name raises a note, a dash below the note lowers it.

The display shows:

- c:: c sharp (C[#])
- E.: e flat (E_b)



5.6.5 Saving parameter settings

The CDP2000-BK allows you to save the changes made to the instrument's settings, so that they won't get lost when the unit is powered down. When the save function is not active, all changes made to the settings – except for the music sequencer data – will be lost when you switch the piano off. When switched back on, the CDP2000-BK recalls the factory default settings.

The save function can be activated separately for the following groups of functions: sounds, MIDI, tuning and damper pedal.

Please enter EDIT mode (see chapter 5.1) and select the following function.

► Sounds

You can save the following settings for this group of functions:

- ▲ Sounds (see chapter 2.4)
- ▲ Layer mode settings (see chapters 4.1 and 5.3)
- ▲ Type of room effect and intensity (see chapter 4.2.2)
- ▲ Type of modulation effect and intensity (see chapter 4.2.3)
- ▲ Key velocity (see chapter 5.6.1)
- ▲ Metronome meter and tempo (see chapter 5.4)
- ▲ Dimmed volume (see chapter 5.5.5)

Function: EB.1

Value: on, off

Description:

off: Save function for sounds is disabled (default setting)

on: Save function for sounds is enabled

► MIDI

You can save the following settings for this group of functions:

- ▲ All MIDI settings (see chapter 6.3.3)

Function: EB.2

Value: on, off

Description:

off: Save function for MIDI settings is disabled (default setting)

on: Save function for MIDI settings is enabled

► Tuning

You can save the following settings for this group of functions:

- ▲ Transposition (see chapter 5.2)
- ▲ Fine tuning (see chapter 5.6.3)
- ▲ Tuning (see chapter 5.6.4)

Function: EB.3

Value: on, off

Description:

off: Save function for tuning settings is disabled (default setting)

on: Save function for tuning settings is enabled

► Soft pedal

You can save the following settings for this group of functions:

- ▲ Soft pedal function (see chapter 5.5.8)
- ▲ Soft pedal intensity (see chapter 5.6.2)

Function: EB.4

Value: on, off

Description:

off: Save function for soft pedal settings is disabled (default setting)

on: Save function for soft pedal settings is enabled

5.6.6 Restoring the factory default settings

Use the following procedure to recall the factory default settings.

Tip: All saved parameters as well as the music sequencer data will be lost during either one of the following procedures.

- 1) Use the POWER switch to switch the instrument off (if not already done).
- 2) Play and hold down the top C key on the keyboard, then switch the CDP2000-BK back on.

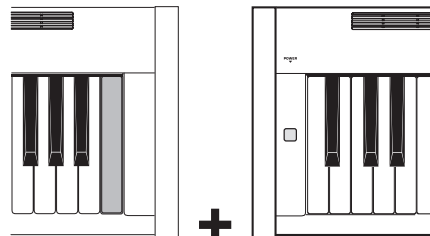

An alternative procedure is described below:

- 1) Use the POWER switch to switch the instrument off (if not already done).
- 2) Press and hold down the TRACK 1 and TRACK 2 buttons, then switch the CDP2000-BK back on.

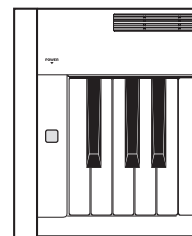
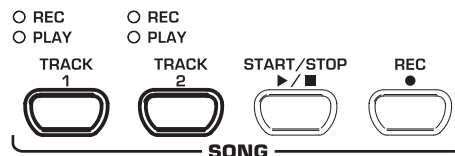

- 3) Let go of the TRACK buttons after about 5 seconds.

6. Connection to external equipment

The CDP2000-BK provides a variety of connectors for connecting the instrument to external devices.

Caution

Be sure that all devices are switched off before you make any connection.

NEVER connect the LINE IN connectors of the CDP2000-BK to its LINE OUT connectors. This will cause a feedback loop producing high volume levels which could damage both the instrument and your hearing!

6.1 Connecting external sound sources

The CDP2000-BK is equipped with a stereo LINE IN connector for connecting external sound sources to your digital piano. These signals are reproduced through the internal loudspeakers and connected headphones. If you wish to practise with musical accompaniment, you can use this input to connect a CD player or drum computer. In the same way, you could connect an external synthesizer or sound module and use its sound generator with your

instrument. An additional MIDI connection enables you to play an external sound generator from the keyboard of the CDP2000-BK (see chapter 6.3.1).

The following diagram shows a wiring example comprising the CDP2000-BK and a CD player. You need one or two cables fitted with 1/4" or cinch plugs (see chapter 9.1.3). As an alternative, you can also use a cinch or 1/4" cable with an appropriate adapter plug.

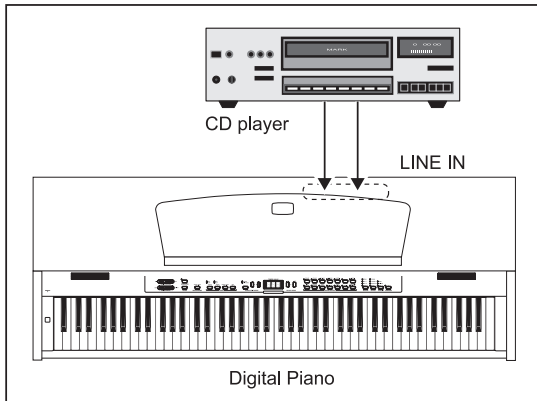

Fig. 6.1: Connecting external signal sources

- 1) Connect the outputs of the CD player to the LINE IN connectors of the CDP2000-BK.

For a mono connection use the LINE IN L (MONO) connector on the CDP2000-BK.

6.2 Connection to amplifiers and recording equipment

The CDP2000-BK is equipped with two LINE OUT connectors for connecting the digital piano to external keyboard amplifiers, P.A. systems or home stereo systems. For performances in larger rooms (e.g. stages, hall) it can be necessary to use external amplifiers.

You can also use the outputs to connect recording equipment (e.g. computer, cassette recorder, MD recorder). Unlike the built-in music sequencer, recording on external audio equipment gives you the advantage that you can play back your music completely independently of the CDP2000-BK. For example, you can give your friends a recorded CD or MD or archive music pieces on any recording medium.

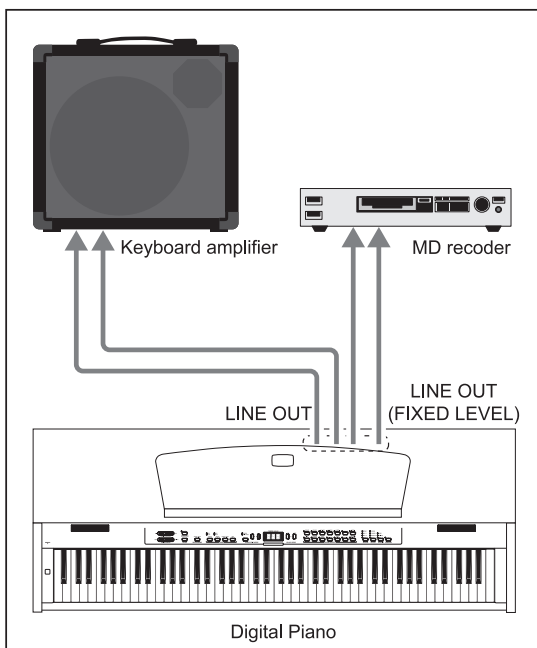

Fig. 6.2: Connecting amplifiers and recording equipment

- 1) Connect the LINE OUT jacks to the inputs of an external amplifier.
- For a mono connection use the LINE OUT L (MONO) connector on the CDP2000-BK.**
- 2) Connect the LINE OUT cinch jacks to the inputs of an external recording device.

Caution

Be sure to switch the CDP2000-BK on, BEFORE you switch on the external amplifier, so as to avoid switch-on thumps being amplified. Such signals could damage the amplifier and the loudspeakers. Switch off the equipment in reverse order.

6.3 MIDI functions

MIDI is an interface and protocol for transmitting of playing data to other MIDI equipment. The most important playing data are pitch and length of notes, key velocity and channel volume, program changes and various controller data generated, for example, by controllers such as the pedals.

The MIDI interface does not transmit electrical audio signals but control data only. The MIDI protocol provides for the transmission of data on 16 independent channels. Playing data are always channel-specific data.

The CDP2000-BK is equipped with three MIDI jacks for connecting additional MIDI sound modules or software/hardware sequencers:

- ▲ Use the MIDI OUT to connect additional synthesizers or a music computer receiving MIDI data from the CDP2000-BK.
- ▲ Use the MIDI IN to send playing data from other MIDI controller keyboards or a music computer to the sound generator of the CDP2000-BK.
- ▲ The MIDI THRU jacks passes on the MIDI data received via the MIDI IN jack without modification. In combination with a music computer you can thus integrate another keyboard or sound module into the MIDI chain comprising CDP2000-BK and music computer.

6.3.1 MIDI connection to other sound modules

You can use the CDP2000-BK to control external sound modules via MIDI. This allows you to use the keyboard and pedals of the digital piano to control the sound generators of other synthesizers or sound modules not equipped with a keyboard. When you also connect the audio signal of the external sound module to the CDP2000-BK, as described in chapter 6.1, all sounds played in addition to the sounds of the CDP2000-BK can be heard through the loudspeakers of the digital piano.

The following illustration shows a set-up comprising the CDP2000-BK and an external sound module.

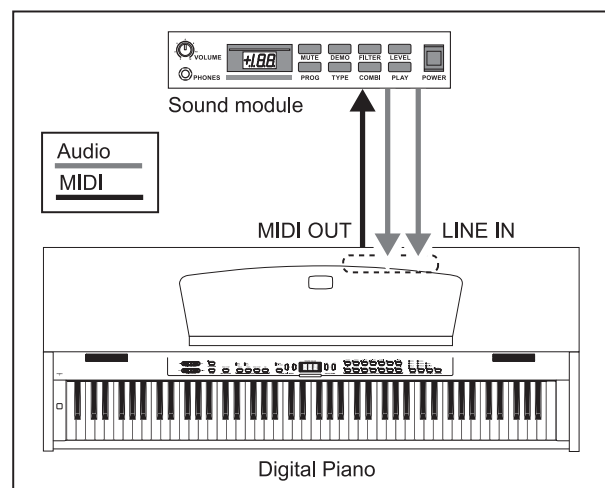

Fig. 6.3: Controlling external MIDI sound modules

- 1) Connect the MIDI OUT jack of the CDP2000-BK to the MIDI IN jack of the external sound module.
- 2) Be sure to set the MIDI transmit/receive channels of both instruments to the same number (see chapter 6.3.3).
- 3) Connect the audio outputs of the sound module to the LINE IN jacks of the CDP2000-BK, if you want to play back the sounds of the external device through the digital piano loudspeakers.

6.3.2 MIDI connection to a computer with sequencing software

You can operate the CDP2000-BK in combination with a sequencing program such as "Cubase" or "Logic". Sequencing software gives you a wealth of powerful functions to record and process MIDI data. For example, you can record several tracks to create complex music pieces. Additional options are the production/printing of sheet music or playback of music pieces. What is more, you can transfer the data of the built-in music sequencer to your computer for permanent archiving.

The following illustration shows a set-up comprising the CDP2000-BK and a music computer. The connection of an external sound module is optional.

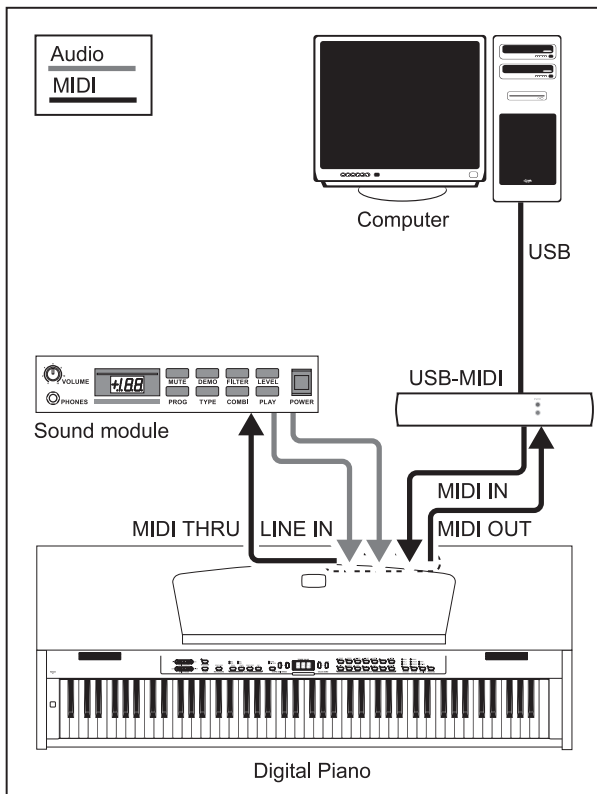

Fig. 6.4: MIDI set-up including a sequencer and external sound module

- 1) Connect the MIDI OUT jack of the CDP2000-BK to the MIDI IN jack of a MIDI sound card.
- 2) Connect the MIDI IN jack of the CDP2000-BK to the MIDI OUT jack of the sound card.
- 3) Connect the MIDI IN jack of the sound module to the MIDI THRU jack of the CDP2000-BK.
- 4) Connect the audio outputs of the sound module to the LINE IN jacks of the CDP2000-BK, if you want to play back the sounds of the external device through the digital piano loudspeakers.

6.3.3 MIDI settings

The CDP2000-BK provides eight different functions to determine how the instrument processes MIDI information.

Please enter EDIT mode (see chapter 5.1) and select the following function.

▶ Setting the MIDI transmit channel

Use this function to set the transmit channel on which the CDP2000-BK is to send MIDI data. MIDI devices must send and receive on the same MIDI channels to ensure successful MIDI communication.

Function: E 7.1

Value: 1 ... 16, OFF

Description:

1 ... 16: The CDP2000-BK transmits MIDI data on the specified MIDI channel. (Default setting: 1)

OFF: The CDP2000-BK transmits no MIDI data

In layer mode voice #1 transmits MIDI data on the specified MIDI channel, while voice #2 transmits on the next higher channel.

Demo song and music sequencer data are not transmitted via the MIDI output. However, you can transmit a music piece recorded with the built-in music sequencer using the MIDI dump feature (see „Sending music sequencer data“ below).

▶ Setting the MIDI receive channel

Use this function to set the receive channel on which the CDP2000-BK is to receive MIDI data. MIDI devices must transmit and receive on the same MIDI channels to ensure successful MIDI communication. Select the default setting *RL* for proper operation in combination with a music computer.

Function: E 7.2

Value: RL, 1-2, 1 ... 16

Description:

RL: Simultaneous multi-timbral reception of MIDI data on all 16 MIDI channels. (Default setting)

1-2: Reception of MIDI data on channels 1 and 2

1 ... 16: Reception of MIDI data on the specified MIDI channel

The multi-timbral reception of MIDI data allows you to use the CDP2000-BK in combination with a sequencing program as a sound generator for multi-track recordings (see chapter 6.3.2).

▶ Enable/disable sound generator (Local on/off)

This function allows you to determine whether the built-in sound generator directly plays the notes you play on the keyboard or whether it only responds to MIDI note information received via the MIDI IN jack. The latter setting is quite useful, for example, in sequencer mode. In a closed MIDI chain the looping through of MIDI signals could otherwise lead to double sounds, i.e. when you hit a key on the keyboard, the CDP2000-BK plays the note directly only to play it again shortly after, when the MIDI commands sent to the sequencer come back via the MIDI IN of the CDP2000-BK. When the CDP2000-BK is set to Local Off, the MIDI data are only sent to the sequencer. The notes are played only once when the MIDI signals come back from the sequencer.

Function: E 7.3

Value: ON, OFF

Description:

ON: Sound generator responds to keyboard and MIDI notes (default setting)

OFF: Sound generator does not respond to the keyboard but to MIDI notes only

► Accept/ignore program changes

Use this function to determine how the CDP2000-BK responds to MIDI program change commands. These commands are used, for example, to select sounds of the CDP2000-BK using MIDI commands sent from a sequencing program. Conversely, program change commands can be sent via the MIDI output of the CDP2000-BK whenever you select a sound in the SOUND SELECT section (see chapter 9.2).

Function: E 7.4

Value: on, off

Description:

- on: Program change commands are sent and received (default setting)
- off: Program change commands are neither sent nor received

► Accept/ignore MIDI controller information

Use this function to determine how the CDP2000-BK responds to MIDI controller data. MIDI uses a variety of controller information to control sound changes (e.g. pedal status, volume, effect intensity).

Function: E 7.5

Value: on, off

Description:

- on: Controller data are sent and received (default setting)
- off: Controller data are neither sent nor received

The CDP2000-BK only responds to the commands listed in the MIDI implementation chart if controller data are enabled (see chapter 9.4).

► MIDI transposition

This function determines whether outgoing MIDI data are transposed independently of the built-in sound generator. This can be useful to play the sounds of an external sound module whose sound generator is controlled from the keyboard of the CDP2000-BK in a different pitch than the internal sounds of the CDP2000-BK.

Function: E 7.6

Value: - i2 ... i2

Description:

- 0: No transposition of the pitch at the MIDI output (default setting)
- i ... i2: Pitch is transposed up by the number of half-tones selected
- i ... - i2: Pitch is transposed down by the number of half-tones selected

This setting has no effect on the sound generator of the CDP2000-BK.

► Send control panel settings (snapshot)

Use this function to transmit the current settings of the CDP2000-BK (e.g. sounds and effects, channel volume) via the MIDI output. This type of transmission only includes system-exclusive data packages (MIDI dump).

Function: E 7.7

Value: -

Description:

- 1) Connect the CDP2000-BK to a computer or hardware sequencer as described in chapter 6.3.2.
- 2) Set the MIDI sequencer to reception-ready mode.
- 3) Select the function E 7.7 in EDIT mode.

- 4) Press the +/YES button to execute the transmission.

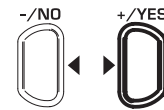

VALUE/SONG

When the transmission is complete, the display shows *End*.

You can send the data back to the CDP2000-BK at a later date. To do this, use the MIDI IN jack to connect the CDP2000-BK to the device that received the data before. As soon as you start the transmission from the MIDI sequencer, the CDP2000-BK will automatically receive the data. Make sure that neither DEMO, EDIT or music sequencer mode is active!

► Sending music sequencer data

Use this function to send music sequencer data via the MIDI output of the CDP2000-BK. This allows you to archive recorded music pieces on your music computer or hardware MIDI sequencer. This type of transmission is only for system-exclusive data packages (MIDI dump), but not for MIDI playing data.

Function: E 7.8

Value: -

Description:

- 1) Connect the CDP2000-BK to a computer or hardware sequencer as described in chapter 6.3.2.
- 2) Set the MIDI sequencer to reception-ready mode.
- 3) Select the function E 7.8 in EDIT mode.
- 4) Press the +/YES button to execute the transmission.

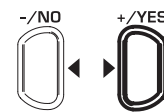

VALUE/SONG

When the transmission is complete, the display shows *End*.

You can send the data back to the CDP2000-BK at a later date. To do this, use the MIDI IN jack to connect the CDP2000-BK to the device that received the data before. As soon as you start the transmission from the MIDI sequencer, the CDP2000-BK will automatically receive the data. Make sure that neither DEMO, EDIT or music sequencer mode is active!



7. Troubleshooting

Problem	Remedy
The instrument cannot be switched on	▲ Check the connection between mains plug and wall outlet (see chapter 3.1).
No sound	▲ Check the position of the MAIN VOLUME control (see chapter 3.2). ▲ Check the SPEAKER button status (see chapter 5.4). ▲ Check that the sound generator is switched on (see chapter 7.3.3).
The foot pedals do not work properly	▲ Check that the pedal cable is properly connected to the PEDAL jack on the underside of the piano (see chapter 2).
The left foot pedal has no effect	▲ Check in EDIT menu $E4$. f that the soft pedal function is enabled (see chapter 6.5.8).
Audio signal is distorted	▲ Cut back the volume using the MAIN VOLUME control.
Sound is too low/high	▲ Check whether the LED above the TRANSPOSE switch is lit. If so, transposition is active. Press the button to switch if off.
Effect is not audible	▲ Perhaps no effect has been selected or its intensity is too low. Check that the REVERB and EFFECT LEDs are lit and select an appropriate effect intensity (see chapters 5.2.2 and 5.2.3).
Music sequencer/DEMO mode cannot be selected	▲ DEMO mode must not be active when you switch to music sequencer mode. Conversely, the music sequencer must be off before you can switch to DEMO mode.
The music recorded with the music sequencer has been lost	▲ When you re-record a track this will automatically erase the previously recorded data on this track.
Music sequencer playback cannot be started	▲ Playback can only be started when the memory of the music sequencer contains data. Perhaps no data have been recorded. ▲ Perhaps no tracks have been activated for recording. Proceed as described in chapter 6.5.3.
The music sequencer has not stored the entire recording	▲ The music sequencer is limited in its capacity (approx. 10,000 notes). When the memory is full, all further data will be lost. Play only as many notes as the sequencer can store before the display starts flashing, thus signaling that the memory is full.
The display shows <i>FULL</i>	▲ The memory of the music sequencer is full. If you do not want to erase/re-record your recording, be sure to save the recorded song via MIDI to a music computer (see chapters 7.3.2 and 7.3.3) before you start a new recording.
The music piece recorded on the music sequencer plays back too slow/fast	▲ The playback tempo of the music sequencer follows the current tempo setting. Press the SELECT button until the TEMPO LED lights up, then simultaneously press the two ◀ ▶ buttons to play back the recording at its original tempo.
The tuning of the instrument does not match the tuning of other instruments	▲ Check the settings in the EDIT menus $E1$ and $E2$. f and adjust them if necessary, as described in chapter 6.6.3. Standard setting: 440 Hz, equal tuning.
Key velocity does not work properly	▲ Check whether one of the LEDs above the VELOCITY button is lit. If necessary activate the dynamic response of your choice by pressing the VELOCITY button (see chapter 6.6.1). ▲ Some sounds do not respond to key velocity (see chapter 10.2).
When the instrument is switched off all settings are lost	▲ When first switched on, the piano always uses the default settings. To save your personal settings please set the memory function as described in chapter 6.6.5.
The piano does not play back notes received via MIDI IN	▲ Set the receive channel, on which the piano is to receive MIDI data, in the EDIT menu $E7.2$, as described in chapter 7.3.3.
The piano does not transmit MIDI data via MIDI OUT	▲ Set the transmit channel, on which the piano is to send MIDI data, in the EDIT menu $E7.1$, as described in chapter 7.3.3. Demo and music sequencer data are not transmitted via MIDI.
The piano does not respond to all MIDI commands	▲ The piano supports only those commands listed in the MIDI Implementation Chart. ▲ Be sure that the device sending MIDI data and the piano do not have a MIDI filter activated (see chapter 7.3.3).
The piano sounds strange	▲ Check whether one of the LEDs above the EFFECT button is lit, i.e. whether a modulation effect is active. If so, press the button until all LEDs are off, i.e. no effect is active. ▲ Perhaps you have selected two sounds at the same time. Press one of the sound buttons in the SOUND SELECT section to select a single sound.
The display shows <i>Err</i>	▲ An internal error has occurred. Switch the instrument off, wait for about 30 seconds, then switch it back on. If the error message shows again, please contact your BEHRINGER support desk. Further information can be found at: www.behringer.com .

8. Specifications

Keyboard	88 weighted keys with hammer action (A-1 to C7)
Sound generation	RSM (Real Sound Modeling) stereo sampling, 16 MB ROM
Polyphony	64 notes max.
Sounds	14
Effects	
Room effects	4 types (ROOM, HALL 1, HALL 2, STAGE)
Modulation effects	4 types (CHORUS, FLANGER, TREMOLO, DELAY)
Sequencer	
Type	2-track
Memory	1 Song, approx. 10,000 notes
PEDALS	3 (soft-, sostenuto-, damper)
LINE IN	
Connectors	1/4" TS jack, unbalanced
Impedance	approx. 10 kΩ
Line out	
Connectors	RCA, unbalanced, 1/4" TRS jack, impedance-balanced
Impedance	approx. 100 Ω, unbalanced, approx. 200 Ω, balanced
Max. output level	+7 dBu
Phones	
Connectors	1/4" TRS jack
Max. output level	+13 dBu/120mW @ 100 W load
MIDI	IN, OUT, THRU
Amplifier	
Output power	2 x 40 W
Power supply	
Mains voltages and fuse values	
100 ... 120 V~, 50/60 Hz	T 2,50 A H 250 V
220 ... 230 V~, 50/60 Hz	T 1,25 A H 250 V
Power consumption	approx. 135 W
Dimensions/Weight	
Dimensions (H x W x D)	approx. 880 x 1,405 x 525 mm approx. 34 21/32" x 55 5/16" x 20 43/64"
Weight	approx. 64.6 kg approx. 142.4 lbs

BEHRINGER is constantly striving to maintain the highest professional standards. As a result of these efforts, modifications may be made from time to time to existing products without prior notice. Specifications and appearance may differ from those listed or illustrated.



9. Appendix

9.1 Cables

Below you will find an overview of all cables you need to connect your digital piano. The cables are not supplied with the piano.

Depending on the intended use, adapter cables will be necessary to interface the various connectors. You can use adapter cables or plugs (e.g. 1/4" to cinch). Cable adapters are better than adapter plugs, as the latter may affect the signal quality due to insufficient contact of the plugs with each other.

9.1.1 Unbalanced 1/4" cable

Unbalanced 1/4" cables are equipped with a 1/4" TS plugs at each end. They are used to connect external keyboard amps and devices with 1/4" outputs (e.g. synthesizers, drum computers) to the CDP2000-BK.

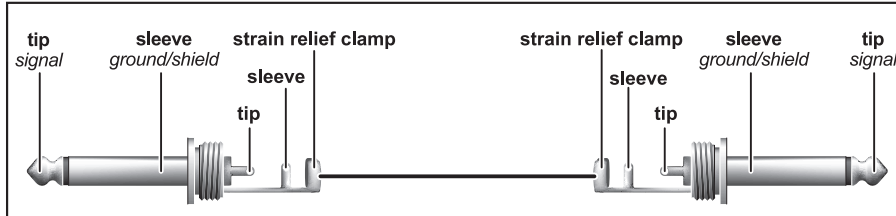

Fig. 9.1: Unbalanced 1/4" cable with 1/4" TS plugs

9.1.2 RCA cables

RCA cables are often used for hi-fi applications to connect CD players, MD recorders and other devices to home stereo systems. You will need this type of cable to connect the CDP2000-BK to hi-fi recording equipment. Usually, these cables are supplied in pairs to form one stereo cable. The plugs are in most cases red (right) and white (left). Make sure that the wiring between recording device and CDP2000-BK follows this color code, so as not to mix up the left/right signals.

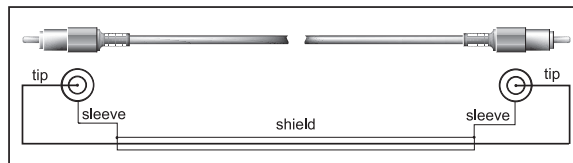

Fig. 9.2: Hi-fi RCA cable

9.1.3 1/4" to RCA cable

1/4" to RCA cables are required for connecting a hi-fi playback device (e.g. CD player) to the CDP2000-BK. As an alternative, you can also use an unbalanced 1/4" cable with an appropriate RCA adapter.

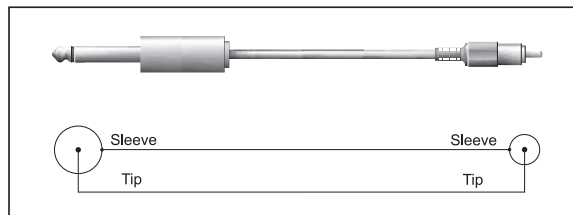

Fig. 9.3: 1/4" to RCA cable

9.1.4 MIDI cables

MIDI cables are required for connecting MIDI equipment. These cables have a 5-pin DIN plug at each end. Be sure to use cables marked as MIDI cables (wiring as shown), since there are also similar cables with a different wiring available for hi-fi equipment. MIDI cable lengths should be as short as possible. Avoid cable lengths exceeding 10 m, as these could lead to errors during the transmission of signals.

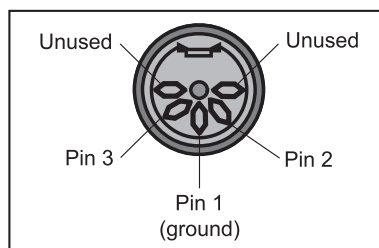

Fig. 9.4: MIDI plug pin assignment

9.2 Presets on the CDP2000-BK

Sound	Description	Stereo samples	Key velocity	Dynamic samples	Release samples	MIDI commands	
						MSB/LSB	Program change commands
GRAND PIANO 1	Classic sound of a concert grand piano with a soft tonal character	✓	✓			0/122	0
GRAND PIANO 2	Brilliant sound of a concert grand piano, particularly suited to pop and rock music	✓	✓			0/112	0
E-PIANO 1	Typical bell-like FM electric piano of the 80's		✓			0/122	5
E-PIANO 2	Nostalgic retro sound of a classic electric piano		✓	✓		0/122	4
HARPSICHORD	Typical sound of a baroque harpsichord	✓			✓	0/122	6
CEMBALO	Full dual-octave harpsichord sound	✓			✓	0/123	6
VIBRAPHONE	Extremely dynamic vibraphone sound	✓	✓			0/122	11
PIPE ORGAN	Soft wooden pipe sound of a small baroque organ					0/123	19
CHURCH ORGAN	Sound of full-size church organ with all registers					0/122	19
JAZZ ORGAN	Sound of a typical jazz organ with percussive attack					0/122	16
STRINGS	Natural sound of a big string orchestra	✓	✓			0/122	48
SOFT STRINGS	Soft sound of a string ensemble with slow attack	✓	✓			0/122	49
CHOIR	Mixed choir with pitch-dependent combination of voices		✓			0/122	52
ACOUSTIC GUITAR	Sound of a classical concert guitar with a warm character	✓	✓			0/122	24



9.3 List of demo music pieces included

No.	Piece	Composer
1	Invention no. 1, C major, BWV 772	Johann Sebastian Bach
2	Piano sonata no. 16, 1st movement, C major, KV 545	Wolfgang Amadeus Mozart
3	Piano sonata, op. 13, no. 8 "Pathétique", 2nd mvt., A flat major	Ludwig van Beethoven
4	Piano sonata, op. 49, no. 2, 1st movement, G major	Ludwig van Beethoven
5	Impromptu, op. 90, no. 2, E flat major	Franz Schubert
6	Frühlingslied ("Spring Song"), op. 62, no. 6, A major	Felix Mendelssohn Bartholdy
7	Fantasie Impromptu, op. 66, c sharp minor	Frédéric Chopin
8	Prelude, op.28, no. 15 "Raindrop", D flat major	Frédéric Chopin
9	Etude, op. 10, no. 12 "Revolution", c minor	Frédéric Chopin
10	Waltz, op. 64, no. 1 "Minute Waltz/Petit chien", D flat major	Frédéric Chopin
11	Waltz, op. 64, no. 2, c sharp minor	Frédéric Chopin
12	Liebestraum no. 3, A flat major	Franz Liszt
13	Arabesque no. 1, E major	Claude Debussy
14	Children's Corner: Golliwog's Cakewalk, E flat major	Claude Debussy
15	Maple Leaf Rag, A flat major	Scott Joplin

9.4 MIDI implementation chart

Function		Transmitted	Recognized	Remarks
Basic Channel	Default	1	1	
	Changed	1 - 16	1 - 16	
Mode	Default	3	1	Poly mode only
	Messages	X	X	
	Altered	X	X	
Note Number		9-120, v=1-127	0-127, v=1-127	
	True Voice	X	0-127	
Velocity	Note ON	O	O	
	Note OFF	X	X	
After Touch	Keys	X	X	
	Channels	X	X	
Pitch Bend		X	X	
Control Change	0,32	O	O	Bank select
	7	O	O	Volume
	11	O	O	Expression
	64	O	O	Damper
	66	O	O	Sostenuto
	67	O	O	Soft pedal
	91	O	O	Reverb depth
	94	O	O	Effect depth
Program Change		O	O	
System Exclusive		O	O	
System Common	Song Pos.	X	X	
	Song Sel.	X	X	
	Tune	X	X	
System Real Time	Clock	O	O	
	Commands	O	O	
Aux Messages	Local ON/OFF	X	O (122)	
	All notes OFF	O	O (123-125)	
	Active Sense	O	O	
	Reset	X	X	
	All sound off	O	O (120, 126, 127)	
	Reset all ctrl	O	O (121)	
Notes				
O = YES, X = NO				
Mode 1: OMNI ON, POLY				
Mode 3: OMNI OFF, POLY				

9.5 EDIT parameters

Category	Abbreviated name	Description	Function	Values	Default setting
Tuning	Fine tuning	General fine tuning in 1/5-Hz steps	E 1	427 - 453	440
Tuning	Tuning	Selection of temperament (scale)	E 2.1	1 ... 7	1 (equal temper)
	Basic note	Selection of basic note of temperament	E 2.2	c ... b	c
Layer mode	Volume	Volume ratio of voice #1 vs. voice #2	E 3.1	0 ... 20	-*
	Detune	Detuning of voice #1 vs. voice #2	E 3.2	- 10 ... 10	-*
	Octave transposition voice #1	Octave position of voice #1	E 3.3	- 1, 0, 1	-*
	Octave transposition voice #2	Octave position of voice #2	E 3.4	- 1, 0, 1	-*
	Effect intensity voice #1	Portion of voice #1 volume channeled to the effect	E 3.5	0 ... 20	-*
	Effect intensity voice #2	Portion of voice #2 volume channeled to the effect	E 3.6	0 ... 20	-*
	Reset	Reset of layer mode settings	E 3.7	-	-
Soft pedal	Function	Function of soft pedal: 1) soft pedal, 2) music sequencer	E 4.1	1, 2	1
	Effect	Intensity of soft pedal on sound	E 4.2	1 ... 5	3
Metronome	Volume	Volume of metronome click	E 5	1 ... 20	10
Sequencer	Dimmed volume	Volume of the muted track in music sequencer mode	E 6	0 ... 20	5
MIDI	Transmit channel	MIDI channel on which MIDI data are transmitted	E 7.1	1 ... 16, OFF	1
	Receive channel	MIDI channel on which MIDI data are received	E 7.2	ALL, 1-2, 1 ... 16	ALL
	Sound generator (Local on/off)	Enables/disables the built-in sound generator for keyboard data	E 7.3	on, OFF	on
	Program change	Accept or ignore program change data (send/receive)	E 7.4	on, OFF	on
	Controller commands	Accept or ignore controller commands (send/receive)	E 7.5	on, OFF	on
	Transposition	Transposition of notes during MIDI transmission	E 7.6	- 12 ... 12	0
	Control panel settings	MIDI transmission of all current settings (dump)	E 7.7	-	-
	Music sequencer data	MIDI transmission of music sequencer data (dump)	E 7.8	-	-
Save	Sounds	Permanent saving of sound settings	E 8.1	on, OFF	OFF
	MIDI	Permanent saving of MIDI settings	E 8.2	on, OFF	OFF
	Tuning	Permanent saving of transposition and tunings	E 8.3	on, OFF	OFF
	Soft pedal	Permanent saving of soft pedal settings	E 8.4	on, OFF	OFF

* Default settings depend on the selected sound combination



10. Warranty

§ 1 Other warranty rights and national law

1. This warranty does not exclude or limit the buyer's statutory rights provided by national law, in particular, any such rights against the seller that arise from a legally effective purchase contract.
2. The warranty regulations mentioned herein are applicable unless they constitute an infringement of national warranty law.

§ 2 Online registration

Please do remember to register your new BEHRINGER equipment right after your purchase by visiting www.behringer.com (alternatively www.behringer.de) and kindly read the terms and conditions of our warranty carefully.

Registering your purchase and equipment with us helps us process your repair claims quicker and more efficiently.

Thank you for your cooperation!

§ 3 Warranty

1. BEHRINGER (BEHRINGER International GmbH including all BEHRINGER subsidiaries listed on the enclosed page, except BEHRINGER Japan) warrants the mechanical and electronic components of this product to be free of defects in material and workmanship for a period of one (1) year* from the original date of purchase, in accordance with the warranty regulations described below. If the product shows any defects within the specified warranty period that are not excluded from this warranty as described under § 5, BEHRINGER shall, at its discretion, either replace or repair the product using suitable new or reconditioned parts. In the case that other parts are used which constitute an improvement, BEHRINGER may, at its discretion, charge the customer for the additional cost of these parts.
2. If the warranty claim proves to be justified, the product will be returned to the user freight prepaid.
3. Warranty claims other than those indicated above are expressly excluded.

§ 4 Return authorization number

1. To obtain warranty service, the buyer (or his authorized dealer) must call BEHRINGER (see enclosed list) during normal business hours BEFORE returning the product. All inquiries must be accompanied by a description of the problem. BEHRINGER will then issue a return authorization number.
2. Subsequently, the product must be returned in its original shipping carton, together with the return authorization number to the address indicated by BEHRINGER.
3. Shipments without freight prepaid will not be accepted.

§ 5 Warranty regulations

1. Warranty services will be furnished only if the product is accompanied by a copy of the original retail dealer's invoice. Any product deemed eligible for repair or replacement under the terms of this warranty will be repaired or replaced.
2. If the product needs to be modified or adapted in order to comply with applicable technical or safety standards on a national or local level, in any country which is not the country for which the product was originally developed and manufactured, this modification/adaptation shall not be considered a defect in materials or workmanship. The warranty does not cover any such modification/adaptation, irrespective of whether it was carried out properly or not. Under the terms of this warranty, BEHRINGER shall not be held responsible for any cost resulting from such a modification/adaptation.
3. Free inspections and maintenance/repair work are expressly excluded from this warranty, in particular, if caused by improper handling of the product by the user. This also applies to defects caused by normal wear and tear, in particular, of faders, crossfaders, potentiometers, keys/buttons, tubes, guitar strings, illuminants and similar parts.
4. Damages/defects caused by the following conditions are not covered by this warranty:
 - ▲ improper handling, neglect or failure to operate the unit in compliance with the instructions given in BEHRINGER user or service manuals.
 - ▲ connection or operation of the unit in any way that does not comply with the technical or safety regulations applicable in the country where the product is used.
 - ▲ damages/defects caused by force majeure or any other condition that is beyond the control of BEHRINGER.
5. Any repair or opening of the unit carried out by unauthorized personnel (user included) will void the warranty.
6. If an inspection of the product by BEHRINGER shows that the defect in question is not covered by the warranty, the inspection costs are payable by the customer.
7. Products which do not meet the terms of this warranty will be repaired exclusively at the buyer's expense. BEHRINGER will inform the buyer of any such circumstance. If the buyer fails to submit a written repair order within 6 weeks after notification, BEHRINGER will return the unit C.O.D. with a separate invoice for freight and packing. Such costs will also be invoiced separately when the buyer has sent in a written repair order.

§ 6 Warranty transferability

This warranty is extended exclusively to the original buyer (customer of retail dealer) and is not transferable to anyone who may subsequently purchase this product. No other person (retail dealer, etc.) shall be entitled to give any warranty promise on behalf of BEHRINGER.

§ 7 Claim for damages

Failure of BEHRINGER to provide proper warranty service shall not entitle the buyer to claim (consequential) damages. In no event shall the liability of BEHRINGER exceed the invoiced value of the product.

* Customers in the European Union please contact BEHRINGER Germany Support for further details.

Technical specifications and appearance are subject to change without notice. The information contained herein is correct at the time of printing. All trademarks (except BEHRINGER, the BEHRINGER logo, JUST LISTEN and CONCERT) mentioned belong to their respective owners, and such use neither constitutes a claim of the trademarks by BEHRINGER nor affiliation of the trademark owners with BEHRINGER. BEHRINGER accepts no liability for any loss which may be suffered by any person who relies either wholly or in part upon any description, photograph or statement contained herein. Colors and specifications may vary slightly from product. Our Products are sold through authorized dealers only. Distributors and dealers are not agents of BEHRINGER and have absolutely no authority to bind BEHRINGER by any express or implied undertaking or representation. This manual is copyrighted. No part of this manual may be reproduced or transmitted in any form or by any means, electronic or mechanical, including photocopying and recording of any kind, for any purpose, without the express written permission of BEHRINGER International GmbH.

ALL RIGHTS RESERVED.
© 2008 BEHRINGER International GmbH,
Hanns-Martin-Schleyer-Str. 36-38, 47877 Willich-Muenchheide II, Germany.
Tel. +49 2154 9206 0, Fax +49 2154 9206 4903